

IMPORTANT SAFETY RULES
Read, Understand, and Follow all Instructions Carefully before Installing and using this Product.

Krystal Clear™ Model 638 Filter Pump

220 - 240 V~, 50 Hz, 85 W
Hmax 1.0 m, H min 0.19 m, IPX7
Max. Water Temperature 35 °C



For illustrative purposes only.

Don't forget to try these other fine Intex products: Pools, Pool Accessories, Inflatable Pools and In-Home Toys, Airbeds and Boats available at fine retailers or visit our website.



©2006 Intex Marketing Ltd. - Intex Development Co. Ltd. - Intex Recreation Corp.
All rights reserved/Tous droits réservés/Todos los derechos reservados/Alle Rechte vorbehalten.

Printed in China/Imprimé en Chine/Impreso en China/Gedruckt in China.
©™ Trademarks used in some countries of the world under license from/©™ Marques utilisées dans certains pays sous licence de/Marcas registradas utilizadas en algunos países del mundo bajo licencia de/Warenzeichen verwendet in einigen Ländern der Welt in Lizenz von/Intex Marketing Ltd. to/à/a/an Intex Development Co. Ltd., 8th Floor, Dah Sing Financial Centre, 108 Gloucester Road, Wanchai, Hong Kong & Intex Recreation Corp., P.O. Box 1440, Long Beach, CA 90801 • Distributed in the European Union by/Distribué dans l'Union Européenne par/Distribuido en la unión Europea por/Vertrieb in der Europäischen Union durch/Intex Trading B.V., P.O. Box nr. 1075 - 4700 BB Roosendaal - The Netherlands

TABLE OF CONTENTS

Warnings..... 3

Parts List & Reference..... 4-5

Set Up Instructions 6-7

Stationary Mounting Option..... 8

Maintenance..... 9

Pool Care and Chemicals..... 10

Long Term Storage..... 10

Troubleshooting Guide..... 11

Common Pool Problems..... 12

General Aquatic Safety..... 13

Limited Warranty..... 14

Intex Service Center Locations..... 15

IMPORTANT SAFETY RULES

Read, Understand and Follow All Instructions Carefully Before Installing and Using this Product.

READ AND FOLLOW ALL INSTRUCTIONS**⚠ WARNING**







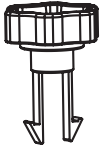

- To reduce the risk of injury, do not permit children to use this product. Always supervise children and those with disabilities.
- Risk of electric shock. Connect this product only to a grounding type receptacle protected by a ground-fault circuit interrupter (GFCI) or residual current device (RCD). Contact a qualified electrician if you cannot verify that the receptacle is protected by a GFCI/RCD. Use a qualified electrician to install the GFCI/RCD, which has a maximum rate of 30mA. Do not use a portable residual current device (PRCD).
- Do not bury electrical cord. Locate cord where it will not be damaged by lawn mowers, hedge trimmers, and other equipment.
- The supply cord cannot be replaced. If the cord is damaged the appliance should be scrapped.
- To reduce the risk of electric shock, do not use extension cords, timers, plug adaptors or converter plugs to connect unit to electric supply; provide a properly located outlet.
- Assembly and disassembly by adults only.
- Do not attempt to plug in or unplug this product while standing in water or when your hands are wet.
- Position this product away from pool to prevent a child from climbing on pump to access the pool.
- Children must stay away from this product and electrical cord(s).
- Do not operate this product when pool is occupied.
- Always unplug this product from the electrical outlet before removing, cleaning, servicing or making any adjustment to the product.
- This product is for use with storable pools only. Do not use with permanently installed pools. A storable pool is constructed so that it may be readily disassembled for storage and reassembled to its original configuration.
- Keep this product more than 2m away from the pool. (for France only).
- Keep the plug of this product more than 3.5m away from the pool.
- The plug shall be accessible after product installed.
- This product is intended to be used only for the purposes described in the manual!

FAILURE TO FOLLOW THESE WARNINGS MAY RESULT IN PROPERTY DAMAGE, ELECTRIC SHOCK, ENTANGLEMENT OR OTHER SERIOUS INJURY OR DEATH.

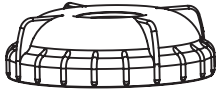
These product warnings, instructions and safety rules provided with the product represent some common risks of water recreation devices and do not cover all instances of risk and danger. Please use common sense and good judgement when enjoying any water activity.

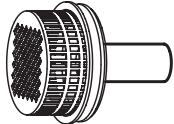
PARTS LIST

PARTS LIST

1 	2 	3 
4 	5 	6 
7 	8 	9 

NOTE: Drawings for illustration purpose only. May not reflect actual product. Not to scale.

PARTS REFERENCE

Before assembling your product, please take a few minutes to check the contents and become familiar with all the parts.

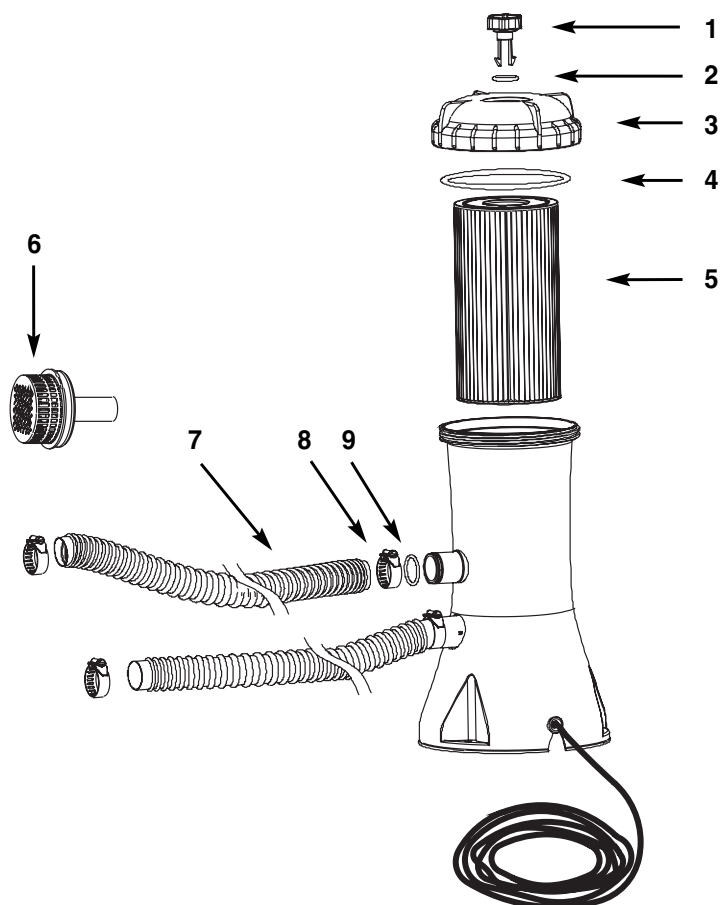

NOTE: Drawings for illustration purpose only. May not reflect actual product. Not to scale.

REF. NO.	DESCRIPTION	QTY.	SPARE PART NO.
1	AIR RELEASE VALVE	1	10460
2	VALVE O-RING	1	10264
3	THREADED COVER	1	10459
4	COVER SEAL	1	10325
5	FILTER CARTRIDGE (59900)	1	
6	STRAINER	2	10120
7	HOSE	2	10399
8	HOSE CLAMP	4	10122
9	HOSE SEAL	2	10134

When ordering parts, be sure to quote the model number and part numbers.

SET-UP INSTRUCTIONS

Be sure you have access to water to fill the pool and chemicals for the water. A small coin can be used to tighten the hose clamps (8).

IMPORTANT: This filter pump is shipped with the air release valve (1) open (open the air release valve if necessary). DO NOT replace the air release valve until you reach STEP #8. Failure to follow these instructions will result in air trapped inside filter housing; the motor will run dry, be noisy and malfunction.

1. Assemble above-ground-pool first. Carefully follow the pool's installation instructions.
2. Place the Filter-Pump the length of the hose away from the pool wall where the lower black protruding hose connection is "sticking-out".
3. Remove wall plugs and then insert the strainers (6) into each of the protruding hose connections. The hoses (7) fit over the strainers inserted into the connections.
4. There are two hoses to be connected to the Filter-Pump hose connections. With hose clamps (8), fasten one of the hoses (7) to the lower protruding hose connection (marked "+" on the pool liner) and to the pump connection (marked "+").
5. Connect the second hose to the remaining upper protruding hose connection and to the lower pump connection. Make sure all the hose clamps (8) are tight.
6. Twist the Filter-Pump's threaded cover (3) in a clock-wise direction to be sure it is on "tight". Use only your hands to tighten the top. Do not tighten with tools such as pliers.
7. Fill the pool to a level of at least 1-2 inches above the top connection. The water will automatically flow down into the pump.
8. When water starts flowing out of the air release valve hole, screw in the air release valve back into the filter housing cover. Do not over tighten the valve.
NOTE: Venting the system is necessary for air to escape as the filter housing fills with water.
9. Connect the filter pump to the power outlet. The filter pump is now filtering the water.

WARNING

Risk of electric shock. Connect this product only to a grounding type receptacle protected by a ground-fault circuit interrupter (GFCI) or residual current device (RCD). Contact a qualified electrician if you cannot verify that the receptacle is protected by a GFCI/RCD. Use a qualified electrician to install the GFCI/RCD, which has a maximum rate of 30mA. Do not use a portable residual current device (PRCD).

10. Operate the filter pump until the desired water clarity is obtained.

SET-UP INSTRUCTIONS (continued)

⚠ WARNING

Position this product away from pool to prevent a child from climbing the pool.

To inspect and change the filter cartridge, disconnect line cord, unscrew the strainer grids (6) from the strainer connectors and insert the hat-like plugs into the strainer connectors before servicing the filter. After service, open the air release valve, remove the plugs, allow any air to escape through the valve before tightening the valve again and replace the strainer grids. The pump is now primed with water again and may be turned on.

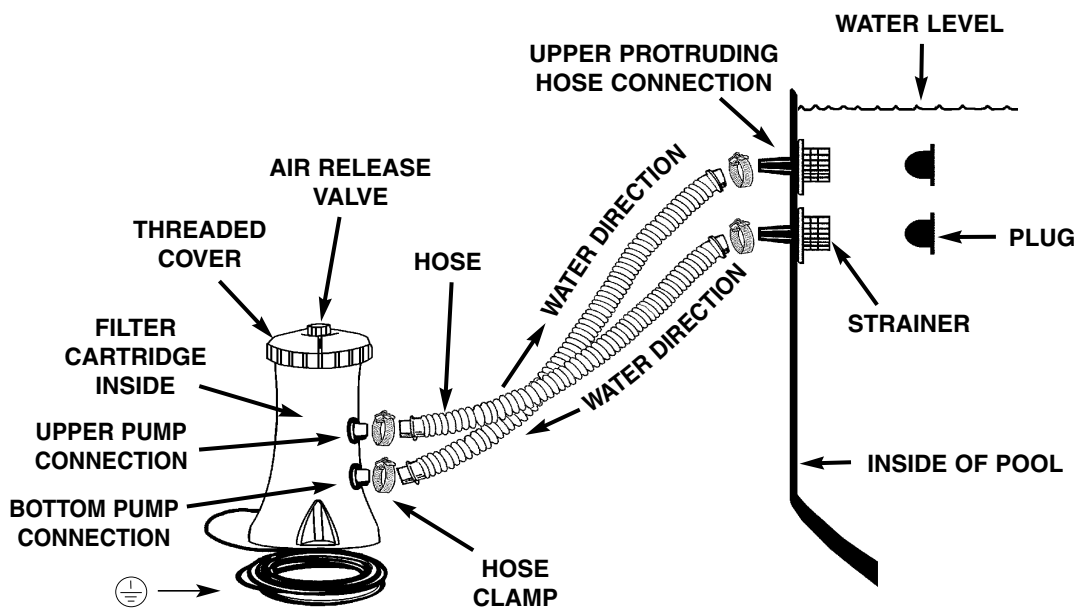

(ILLUSTRATION NOT TO SCALE)

FILTER PUMP STATIONARY MOUNTING OPTION

There are three mounting holes located at the bottom of the filter-pump base. These holes are provided because various country's regulations, especially in the European community, require the filter-pump to be secured to the ground or to a base in a permanent upright position.

These three holes form a triangle pattern and are 145mm from each other. The holes are slotted with a 7mm width.

The filter-pump can be mounted on a cement base or onto a wooden structure to prevent accidental falling over. Total assembly must exceed 18kg. The drawings on the following show two possible ways of upright mounting. The European norm EN 60335-2-41 requires this product be secured to the ground or to a base.

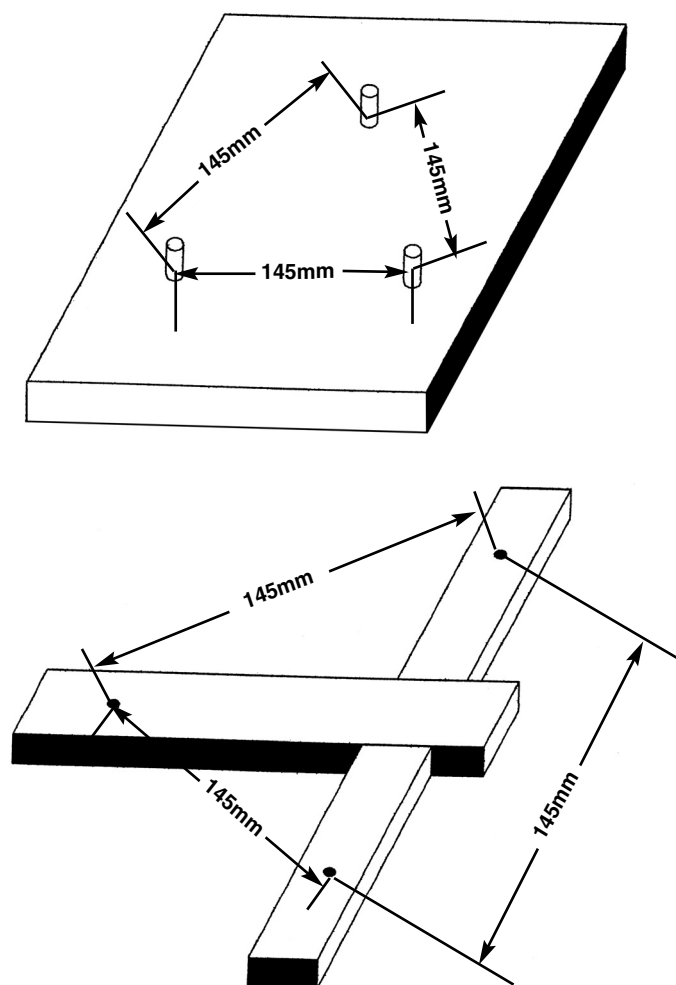

 -- (3) x M6 HEXAGON LOCK-NUTS

 -- (3) x M6 HEXAGON HEAD BOLTS

STATIONARY MOUNTING OPTION

SAVE THESE INSTRUCTIONS

Page 8

FILTER CARTRIDGE CLEANING OR REPLACEMENT

It is recommended that the filter cartridge be replaced at least every 2 weeks.

1. Make sure filter pump is not operating. Disconnect line cord.
2. To prevent water from escaping the pool, unscrew the strainer grids from the strainer connectors and insert the hat-like plugs into the strainer connectors.
3. In a counter-clockwise motion, remove threaded cover **(3)** and cover seal **(4)**. Be careful not to lose the cover seal **(4)**.
4. Remove filter cartridge **(5)** to clean it. The filter may be cleaned from the spray from a water hose.
5. Use judgement as to whether cartridge needs to be replaced.
6. Return cartridge to filtering position.
7. Return the seal **(4)** and threaded cover **(3)** to their original positions. Tighten the threaded cover **(3)** by hand only, twisting it in a clock-wise direction.
8. After service, open the air release valve, remove the plugs, allow any air to escape through the valve before tightening the valve again and replace the strainer grids. The pump is now primed with water again and may be turned on.

POOL CARE AND CHEMICALS

- All pools require care to keep the water clear and hygienically clean. With proper chemical control, your filter will help attain this objective. Consult your pool supply dealer for instructions regarding the proper use of chlorine, algaecide and other chemical agents required for sparkling clear water.
- Keep pool chemicals away from children.
- Do not replenish chemicals in pool while pool is occupied. Skin or eye irritations could occur.
- Daily pH checking and chemical treatment of the water is very important and can not be overemphasized. Chlorine, algaecide and maintenance of proper pH levels are required when filling the pool as well as during the season. Consult your local swimming pool supply store for instructions.
- The season's first filling of the pool may have brackish water requiring extra water additives and extra filter changes. Do not allow swimming in pool until the pH level is balanced. Consult your local swimming pool supply store for instructions.
- Keep spare filter cartridges on hand. Replace cartridges every two weeks.
- Chlorinated water may damage lawns, gardens or shrubbery as children play in the pool and splash water outside the pool. Lawn areas underneath the pool liner will be destroyed. Note that some types of grass may grow through the liner but function is not affected.
- Filter run time depends on pool size, weather and usage level. Experiment with various run times so as to produce clean clear water.

⚠ CAUTION

Concentrated chlorine solutions may damage the pool liner. Always follow the chemical manufacturer's directions, and the health and hazard warnings.

LONG TERM STORAGE

1. Before emptying your pool for long term storage, or relocation, be sure the water is directed towards an acceptable drain water receptacle away from the house. Check local regulations for specific directions regarding disposal of swimming pool water.
2. After pool is empty of all water, disconnect all pool hoses (7) from pool and filter pump, simply reverse the set up instructions.
3. Remove filter cartridge as shown in the Filter Cartridge Cleaning section, steps 2 thru 4.
4. Remove the strainers (6) from the pool wall. Place the wall plugs into the hose connections. Loosen clamps (8) securing the strainers before removal.
5. Drain water from the filter pump housing.
6. Depending on the cartridge (5) usage, a new cartridge may be needed for next season, keep a spare available.
7. Cover the seal (4), air release valve O-ring (2) and hose seals (9) with petroleum jelly to preserve its resilience during storage.
8. Store the filter pump and accessories in a dry, cool storage location.
9. The original packing carton can be used for storage.

TROUBLESHOOTING GUIDE

TROUBLE	CHECK	POSSIBLE SOLUTIONS
FILTER MOTOR FAILS TO START	<ul style="list-style-type: none"> • Not plugged in. • Fuse box needs checking. • GFCI/RCD circuit breaker tripped. 	<ul style="list-style-type: none"> • Filter cord must be plugged into a 3 wire outlet that is protected by a Class A Ground Fault Circuit Interrupter, or RCD. • Reset circuit breaker. If circuit breaker trips repeatedly, your electrical system may have a defect. Turn off circuit breaker and call an electrician to correct the problem. • Motor too hot and overload protection shut motor off. Let motor cool down.
FILTER DOESN'T CLEAN POOL	<ul style="list-style-type: none"> • Improper chlorine or pH levels. • Filter cartridge dirty. • Cartridge damaged. • Excessively dirty pool. • Strainer screen restricting flow. 	<ul style="list-style-type: none"> • Adjust chlorine and pH level. Consult your local swimming pool supply stores. • Clean or replace cartridge. • Check for holes in cartridge. Replace if damaged. • Operate filter for longer periods. • Clean strainer screen at pool wall inlet.
FILTER DOESN'T PUMP WATER OR FLOW IS VERY SLOW	<ul style="list-style-type: none"> • Inlet/discharge clogged. • Air leak on intake line. • Scale or buildup on cartridge. • Excessively dirty pool. • Filter cartridge dirty. 	<ul style="list-style-type: none"> • Look for obstructions in intake hose or discharge hose inside pool wall. • Tighten hose clamps, check hoses for damage, check pool water level. • Replace cartridge. • Clean cartridge more often.
PUMP DOESN'T WORK	<ul style="list-style-type: none"> • Low water level. • Strainer screen plugged up. • Air leak on intake hose. • Faulty motor or impeller jammed. • Air lock inside cartridge chamber. 	<ul style="list-style-type: none"> • Fill pool to correct water level. • Clean strainer screens at pool inlet. • Tighten hose clamps, check hose for damage. • Check & clear any sticks or leaves in intake to pump. • Open release valve at top of pump.
TOP COVER LEAKING	<ul style="list-style-type: none"> • O-ring missing. • Cover not tight. • Filter cartridge dirty. 	<ul style="list-style-type: none"> • Remove cover & check for O-ring. • Tighten cover (Manually). • Replace or clean cartridge.
HOSE LEAKING	<ul style="list-style-type: none"> • Hose clamps. 	<ul style="list-style-type: none"> • Tighten/change hose clamps.
AIR LOCK	<ul style="list-style-type: none"> • Pump housing and inlet hose air trapped. 	<ul style="list-style-type: none"> • Open air release valve, lift and lower the inlet hose until water starts to flow out of the air release valve, close air release valve.

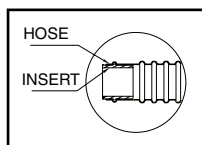

- The white inserts at both ends of the hoses shall remain inside and shall be firmly inserted in the hose. Do not remove the white inserts from the hoses. These white inserts are not serviceable parts.
- To facilitate the connection of the hoses into the black protruding hose connectors on the pool wall, you may use soapy water solution (mix 6 drops of dish detergent in 1/2 a cup of water) to lubricate the inserts by simply dipping the hose ends into the solution. Continue per owner's manual.
- Do not use lubricants such as machine or industrial oil or grease.

COMMON POOL PROBLEMS

PROBLEM	DESCRIPTION	CAUSE	REMEDY
ALGAE	<ul style="list-style-type: none"> • Greenish water. • Green or black spots on pool liner. • Pool liner is slippery and/or has a bad odor. 	<ul style="list-style-type: none"> • Chlorine and pH levels need adjustment. 	<ul style="list-style-type: none"> • Super chlorinate with shock treatment. Correct pH to your pool store's recommended level. • Vacuum pool bottom. • Maintain proper chlorine level.
COLORED WATER	<ul style="list-style-type: none"> • Water turns blue, brown, or black when first treated with chlorine. 	<ul style="list-style-type: none"> • Copper, iron or manganese in water being oxidized by the added chlorine. Common. 	<ul style="list-style-type: none"> • Adjust pH to recommended level. • Run filter until water is clear. • Clean cartridge frequently.
SUSPENDED MATTER IN WATER	<ul style="list-style-type: none"> • Water is cloudy or milky. 	<ul style="list-style-type: none"> • "Hard water" caused by pH level being too high. • Chlorine content is low. • Foreign matter in water. 	<ul style="list-style-type: none"> • Correct pH. Check with pool dealer for water treatment. • Check for proper chlorine level. • Clean or replace your filter.
CHRONIC LOW WATER LEVEL	<ul style="list-style-type: none"> • Level is lower than on previous day. 	<ul style="list-style-type: none"> • Rip or hole in pool liner or hoses. Tighten caps. 	<ul style="list-style-type: none"> • Repair with patch kit. • Finger tighten all caps.
SEDIMENT ON POOL BOTTOM	<ul style="list-style-type: none"> • Dirt or sand on pool floor. 	<ul style="list-style-type: none"> • Heavy use, getting in and out of pool. 	<ul style="list-style-type: none"> • Use Intex pool vacuum to clean bottom of pool.
SURFACE DEBRIS	<ul style="list-style-type: none"> • Leaves, insects etc. 	<ul style="list-style-type: none"> • Pool too close to trees. 	<ul style="list-style-type: none"> • Use Intex pool skimmer.

IMPORTANT

If you continue to experience difficulty, please contact our Consumer Service Department for assistance. See back cover for contact information.

GENERAL AQUATIC SAFETY

Water recreation is both fun and therapeutic. However, it involves inherent risks of injury and death. To reduce your risk of injury, read and follow all product, package and package insert warnings and instructions. Remember, however, that product warnings, instructions and safety guidelines cover some common risks of water recreation, but do not cover all instances or risk and or danger.

For additional safeguards, also familiarize yourself with the following general guidelines as well as guidelines provided by nationally recognized Safety Organizations:

- Demand constant supervision.
- Learn to swim.
- Take the time to learn CPR and first aid.
- Instruct anyone who is watching your children about potential pool hazards and about the use of protective devices such as locked doors, barriers, etc.
- Teach children what to do in case of an emergency.
- Always use common sense and good judgement when enjoying any water activity.
- Supervise, Supervise, Supervise.

LIMITED WARRANTY

Your Krystal Clear™ Filter-Pump has been manufactured using the highest quality materials and workmanship. All Intex products have been inspected and found free of defects prior to leaving the factory. This Limited Warranty applies only to the Krystal Clear™ Filter-Pump.

The provisions of this Limited Warranty apply only to the original purchaser and is not transferable. This Limited Warranty is valid for a period of one (1) year from the date of the initial retail purchase. Keep your original sales receipt with this manual, as proof of purchase will be required and must accompany warranty claims or the Limited Warranty is invalid.

If a manufacturing defect is found within this one (1) year period, please contact the appropriate Intex Service Center listed in this manual. The Service Center will determine the validity of the claim.

IMPLIED WARRANTIES ARE LIMITED TO THE TERMS OF THIS WARRANTY AND IN NO EVENT SHALL INTEX, THEIR AUTHORIZED AGENTS OR EMPLOYEES BE LIABLE TO THE BUYER OR ANY OTHER PARTY FOR DIRECT OR CONSEQUENTIAL DAMAGES OR LIABILITIES.

This Limited Warranty does not apply if the Krystal Clear™ Filter-Pump is subject to negligence, abnormal use or operation, accident, improper operation, improper voltage or current contrary to operating instructions, or to damage by circumstances beyond Intex's control, including but not limited to, ordinary wear and tear and damage caused by exposure to fire, flood, freezing, rain, or other external environmental forces. This Limited Warranty applies only to those parts and components sold by Intex. The Limited Warranty does not cover unauthorized alterations, repairs or disassembly by anyone other than Intex Service Center personnel.

The costs associated with the loss of pool water, chemicals or water damage are not covered by this warranty. Injury or damage to any property or person is not covered by this warranty.

For service questions or to order replacement parts, please contact the appropriate office listed below or visit www.intexdevelopment.com for answers to most frequently asked questions.

AREAS	LOCATION	AREAS	LOCATION
• ASIA	INTEX DEVELOPMENT CO. LTD. 8TH FLOOR, DAH SING FINANCIAL CENTRE, 108 GLOUCESTER ROAD, WANCHAI, HONG KONG TEL: 852-28270000 FAX: 852-23118200 E-mail: xmservicesupport@intexcorp.com.cn Website: www.intexdevelopment.com	• CHILE / ARGENTINA / PERU / URUGUAY	COMEXA S.A SAN IGNACIO 0201, PARQUE INDUSTRIAL PORTEZUELO, QUILICURA, SANTIAGO, CHILE TEL: 56-2-339 9000 FAX: 56-2-339 9022 E-mail: generalsilfa@silfa.cl
• EUROPE	INTEX TRADING B.V. POSTBUS 1075, 4700 BB ROOSENDAAL, THE NETHERLANDS TEL: 31-(0)165-593939 FAX: 31-(0)165-593969 E-mail: service@intexcorp.nl Website: www.intexcorp.nl	• SAUDI ARABIA	SAUDI ARABIAN MARKETING & AGENCIES CO. LTD. PRINCE AMIR MAJED STREET, AL-SAFA DISTRICT, JEDDAH, KINGDOM OF SAUDI ARABIA TEL: 966-2-693 8496 FAX: 966-2-271 4084 E-mail: abid.syed@samaco.com.sa
• FRANCE	INTEX SERVICE (FRANCE) SAS 52, ROUTE NATIONALE 39190 BEAUFORT, FRANCE TEL: 08 90 71 20 39 (0.15 TTC/min) FAX: 03 84 25 18 09 E-mail: sav@intexcorp.com.fr Website: www.intex.fr	• AUSTRIA	STEINBACH GMBH AUSTRIA AISTINGERSTRASSE 2 4311 SCHWERTBERG TEL: 0800 468397665 FAX: 07262 61439-0 E-mail: service@intexcorp.at
• GERMANY	STEINBACH GMBH GERMANY AN DER WELLE 4 60322 FRANKFURT TEL: 0800 468397665 FAX: 07262 61439-0 E-mail: service@intexcorp.de Website: www.intexcorp.de	• CZECH REPUBLIC / EASTERN EUROPE	INTEX TRADING S.R.O. BENESOVSKA 23, 101 00 PRAHA 10 CZECH REPUBLIC TEL: 420-2-717 32247 FAX: 420-2-673 12552 E-mail: info@intexcorp.cz
• ITALY	A & A MARKETING SERVICE OFFICE: VIA DEI MESTIERI 8, 20049 CONCOREZZO, MILANO - ITALY TEL: 39-039-6886260 FAX: 39-039-6043603 E-mail: intex@aeamarketingservice.com Website: www.intexitalia.com	• BELGIUM	N.V. NICOTOY S.A. MOESKROENSENSTEENWEG 383 C, 8511 AALBEKE TEL: 0800 92088 FAX: 32-56.20.37.61 E-mail: intex@nicotoy.be
• UK	WAREHOUSE: C/O ALVI, VIALE DELLA REPUBBLICA 10 - 27100 PAVIA - ITALY TOY BROKERS LTD MARKETING HOUSE, BLACKSTONE ROAD HUNTINGDON, CAMBS. PE29 6EE, UK TEL: 01480 414361 FAX: 01480 414761 E-mail: sales@toybrokers.com Website: www.toybrokers.com	• DENMARK	K.E. MATHIASEN A/S SINTRUPVEJ 12 DK-8220 BRABRAND DENMARK TEL: +45 89 44 22 00 FAX: +45 86 24 02 39 E-mail: intex@keleg.dk
• SWITZERLAND	GWM AGENCY GARTEN-U. WOHNMOBEL RAFFELSTRASSE 25 POSTFACH CH-8045 ZURICH/SWITZERLAND TEL: + 41 - (0)900 - 455 456 FAX: 41 44 455 50 65 E-mail: gwm@gwm.ch Website: www.gwm.ch	• SWEDEN	LEKSAM AB BRANDSVIGSGATAN 6, S-262 73 ÄNGELHOLM, SWEDEN TEL: +46 431 44 41 20 FAX: +46 431 190 35 E-mail: kundtjanst@leksam.se
• SPAIN / PORTUGAL	KOKIDO BVI LIMITED C/PLOMO 5-7, NAVE 19 POLIGONO INDUSTRIAL AIMAYR SAN MARTIN DE LA VEGA 28330 MADRID SPAIN TEL: 34-90-2351045 FAX: 34-91-6912709 E-mail: belen@kokido.com E-mail: info@kokido.com	• NORWAY	NORSTAR AS PINDSLEVEIEN 1 N-3221 SANDEFJORD NORWAY TEL: +47 33 48 74 10 FAX: +47 33 48 74 11 E-mail: intex@norstar.no
• AUSTRALIA	HUNTER OVERSEAS PTY LTD LEVEL 1, 225 BAY STREET, BRIGHTON, VICTORIA AUSTRALIA TEL: 61-3-9596-2144 or 1800-224-094 FAX: 61-3-9596-2188 E-mail: enquiries@hunteroverseas.com.au	• FINLAND	NORSTAR OY RUUKINTIE 20 FIN-02330 ESPOO FINLAND TEL: +358 9 8190 5330 FAX: +358 9 8190 5335 E-mail: info@norstar.fi
• NEW ZEALAND	HAKA NEW ZEALAND LIMITED UNIT 5, SENTINEL PARK, 25 AIRBORNE ROAD, ALBANY PO BOX 302171, NORTH HARBOUR, AUCKLAND 1330 NEW ZEALAND TEL: 649-4159213 FAX: 649-4159212 E-mail: geoff@hakanz.co.nz	• RUSSIA	LLC BAUER KIEVSKAYA STR., 20, 121165 MOSCOW, RUSSIA TEL: 095-249-9400/8626/9802 FAX: 095-742-8192 E-mail: intex@rdm.ru
• MIDDLE EAST REGION	FIRST GROUP TRADING AL MOOSA GROUP BUILDING, 1ST FLOOR, OFFICE 102 & 103, UMM HURAIR ROAD, KARAMA, DUBAI, UAE TEL: 00971-4-3373322 FAX: 00971-4-3375115 E-mail: info@firstgrouptrading.com Website: www.firstgrouptrading.com	• POLAND	KATHAY HASTER UL. LUTYCKA 3, 60-415 POZNAN TEL: +48 61 8498 381/380 FAX: +48 61 8474 487 E-mail: inx@kathay.com.pl
• SOUTH AFRICA	WOOD & HYDE 15-17 PACKER AVENUE, INDUSTRIA 2, CAPE TOWN, SOUTH AFRICA 7460 TEL: 27-21-0800-204-692 FAX: 27-21-505-5600 E-mail: ygoldman@thumb.co.za	• HUNGARY	RECONTRA LTD. H-1113 BUDAPEST, DARÓCZI ÚT 1-3, HUNGARY TEL: +361 372 5200/113 FAX: +361 209 2634 E-mail: gizi@recontra.hu
		• BRAZIL	KONESUL MARKETING & SALES LTDA RUA INACIO BORBA, 835 - CEP. 04715-020, CHACARA SANTO ANTONIO - SÃO PAULO - SP - BRASIL TEL: 55 (11) 5183 8866 FAX: 55 (11) 5183 8866 E-mail: konesulintex@uol.com.br

Free Manuals Download Website

<http://myh66.com>

<http://usermanuals.us>

<http://www.somanuals.com>

<http://www.4manuals.cc>

<http://www.manual-lib.com>

<http://www.404manual.com>

<http://www.luxmanual.com>

<http://aubethermostatmanual.com>

Golf course search by state

<http://golfingnear.com>

Email search by domain

<http://emailbydomain.com>

Auto manuals search

<http://auto.somanuals.com>

TV manuals search

<http://tv.somanuals.com>