



Invacare[®] **I-Transia[™]**

I-Transia 205 kg (450 lb), I-Transia 250 kg (550 lb)

EN Ceiling Hoist
User Manual



This manual **MUST** be given to the user of the product.
BEFORE using this product, read this manual and save for future reference.



Yes, you can.[®]

© 2013 Invacare® Corporation

All rights reserved. Republication, duplication or modification in whole or in part is prohibited without prior written permission from Invacare. Trademarks are identified by ™ and ®. All trademarks are owned by or licensed to Invacare Corporation or its subsidiaries unless otherwise noted.

Contents

1	General	4
1.1	Symbols	4
1.2	Intended Use	4
1.3	Conditions for Use	5
1.4	Service Life	5
1.5	Features	5
2	Safety	6
2.1	General Guidelines	6
2.2	Operating Information	6
	General	6
	Pinch Points and Positioning	7
2.3	Load Limits	8
2.4	Power Supply	8
2.5	Radio Frequency Interference	8
2.6	Product Labeling	9
3	Setup	11
3.1	Included Items	11
3.2	Installing the Hanger Bar Before Use	11
3.3	Before Use	12
4	Operation	13
4.1	Indicator lamps and audio signals	13
4.2	Operating the Hoist	13
4.3	Charging the Battery	14
4.4	Emergency stop and lowering strap	14
	Emergency stop	15
	Emergency lowering	16
	Resetting the emergency stop	17
5	Lifting the Patient	18
5.1	Sling Information	18
5.2	Attaching the Sling	18
5.3	Lifting Information	19
5.4	Lifting to and from a seated position	19
5.5	Lifting to and from a lying position	19
6	After Use	20
6.1	Transport and Storage	20
6.2	Disposal	20
7	Troubleshooting	22
7.1	Troubleshooting Table	22
8	Maintenance	23
8.1	Safe Maintenance	23
8.2	Maintenance and Safety Inspection	23
8.3	Cleaning the Sling and Hoist	24
9	Technical Data	25
9.1	Typical Product Parameters	25
10	Warranty	27
10.1	Limited Warranty — Europe	27
10.2	Limited Warranty — North America	27

I General

I.1 Symbols

Signal words are used in this manual and apply to hazards or unsafe practices which could result in personal injury or property damage. See the information below for definitions of the signal words.



WARNING!

– Warning indicates a potentially hazardous situation which, if not avoided, could result in death or serious injury.



CAUTION!

– Caution indicates a potentially hazardous situation which, if not avoided, may result in property damage or minor injury or both.



IMPORTANT

– Indicates a hazardous situation that could result in damage to property if it is not avoided.



Gives useful tips, recommendations and information for efficient, trouble-free use.



Emergency Stop



Emergency Lowering Function

RESET

Reset emergency stop



Danger — rotating parts



This product complies with Directive 93/42/EEC concerning medical devices.

The launch date of this product is stated in the EC declaration of conformity.



Type B in accordance with IEC/EN 60601-1



Read the manual before use.

I.2 Intended Use

I-Transia is a hoist which covers the need for lifting or moving a person with disabilities in the home care sector, nursing homes, rehabilitation centres, and institutions.

I.3 Conditions for Use

The use of the I-Transia ceiling hoist is subject to the following:

- The I-Transia should only be used by trained personnel.
- The safe working load (SWL), 205 kg (450 lbs) or 250 kg (550 lbs), must not be exceeded. Refer to 2.3 Load Limits, page 8 .
- The instruction offered by Invacare to all customer groups in connection with the purchase of a ceiling-mounted hoist has been received.
- The caregiver pays attention to the well-being of the user when using the hoist.
- The hoist is used in rail systems which are installed, tested and approved according to DS/EN 10535 and Invacare's stipulations.
- Only technicians who have been certified by Invacare may install and test the rail systems.
- The hoist is used with an Invacare hanger bar.
- The hoist is used with an Invacare lifting sling or with other suitable slings. Refer to 5.1 Sling Information, page 18.

I.4 Service Life

The I-Transia has an expected lifetime of 15 years, on the condition of correct use and correct service inspections. Refer to the I-Transia user manual for more information.

I.5 Features

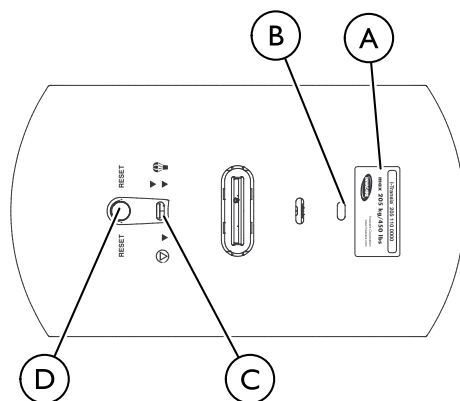

Information panel on the I-Transia bottom surface

(A)	Type and maximum load designation
(B)	Green/yellow battery indicator lamp
(C)	Strap for activating emergency stop and emergency lowering device
(D)	Button for resetting the emergency stop

2 Safety

2.1 General Guidelines



WARNING!

- Read and understand these instructions. **DO NOT** use this product without reading and understanding these instructions. If you need help with these instructions, contact a healthcare professional or an Invacare dealer. Otherwise injury or damage may occur.

ACCESSORIES WARNING

- Invacare products can only be used with accessories made by Invacare. Accessories not made by Invacare have not been tested by Invacare. Accessories not made by Invacare should not be used.

Check all parts for shipping damage before using. In case of damage, **DO NOT** use the equipment. Contact your Invacare dealer for further instructions.



The information contained in this document is subject to change without notice.

2.2 Operating Information

This section of the manual contains general safety information about your product. For specific safety information, refer to the appropriate section of the manual and procedures within that section.

General



WARNING!

Risk of Falling

- DO NOT** attempt any transfer without the consent of the patient's healthcare providers. Read this user manual and observe other personnel lifting patients. Then practice lifting under supervision with a capable person acting as a patient.
- Use common sense in all lifts. Special care **MUST BE** taken with people with disabilities who cannot cooperate while being lifted.
 - Check that the sling attachments are secure on the hanger bar each time the sling is removed and replaced, to ensure that the sling is properly attached before the patient is removed from a stationary object.



WARNING!

- Read the instructions carefully before using the I-Transia and in connection with cleaning and service of the hoist.
- The I-Transia's maximum load must never be exceeded.
- The I-Transia may only be used to lift or move a person.
- The red strap for the emergency stop and the emergency lowering must be adjusted to the caregiver's reach, and must not be removed.
- If the I-Transia fails while in use, stop using the hoist, transfer the patient using a different method and contact an Invacare dealer for repair by a certified technician.
- The I-Transia is controlled by a microprocessor PCB, which can be damaged by static electricity if touched without the necessary precautions,

WARNING!

- The electronics may only be serviced by certified service technicians
- For safety reasons the side cover may only be dismantled when the emergency stop is activated.
- This product is mechanically protected against derailing and jamming.
- The hand control is protected against water splashes (IPX4). **DO NOT** immerse the hand control in liquids, even for a short time. Avoid any contact with water or other liquids.

Pinch Points and Positioning

WARNING!
Risk of Injury

- Pinch points are present on the strap carabiner **A** and fingers could be pinched. The hanger bar **B** can move suddenly and cause injury.
- ALWAYS keep hands and fingers clear of moving parts to avoid injury.
 - When positioning the hoist, be aware of the position of the hanger bar **B** and the patient. Injury could occur.

2.3 Load Limits

Read the label which indicates the maximum load limits for each component.

The component, e.g. hanger bar, lifting sling, etc. labelled with the lowest load limit determines the maximum load limit for the entire system.

This maximum load limit must not be exceeded.

Please note that the max load may change when different components are used, such as hanger bars, lifting slings, etc.

2.4 Power Supply

I-Transia is equipped with a battery that requires regular recharging. The power supply for the transformer and the charging station must be connected by a certified technician.

The transformer supplied must always be used.

Refer to for more information about the power supply.

2.5 Radio Frequency Interference



WARNING!

- Most electronic equipment is influenced by Radio Frequency Interference (RFI). CAUTION should be exercised with regard to the use of portable communication equipment in the area around such equipment. If RFI causes erratic behavior, stop the unit using the hand control or emergency stop. DO NOT use the unit while transmission is in progress.

2.6 Product Labeling

Hoist

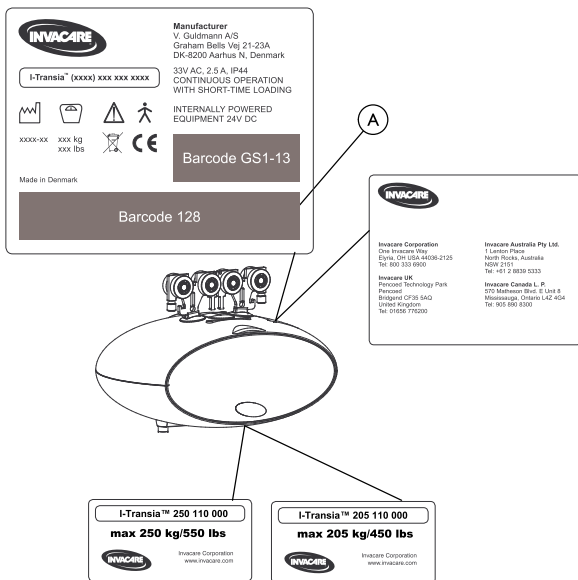

Only one of the weight limit labels are on the bottom of the hoist.

Ⓐ = Serial Number

Power supply



Hand control

Part no. xxxxxx
Edition xxx
Date xxxx-xx-xx
IP44

Hanger Bar

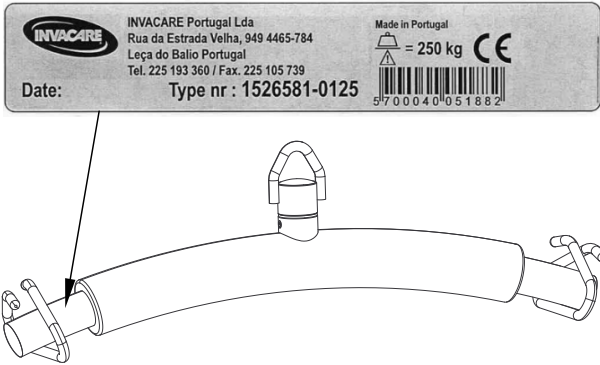

The hanger bar label is located near the end of the hanger bar, to the inside of the hooks.

3 Setup

3.1 Included Items

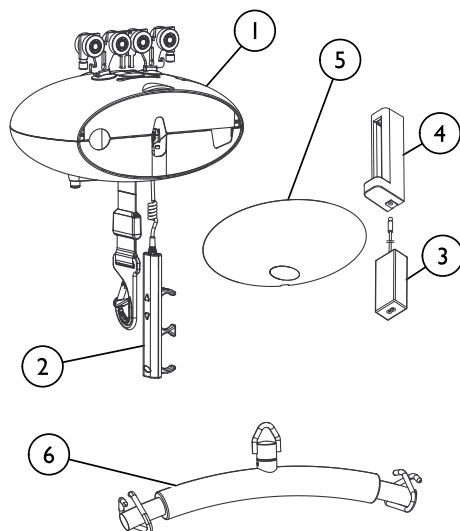

1. I-Transia hoist*
2. Hand control
3. Transformer
4. Charging station
5. Side covers
6. Hanger bar



*The hoist includes the lifting strap, carabiner and trolley.

3.2 Installing the Hanger Bar Before Use



WARNING! **Risk of Injury**

Pinch points are present on the strap carabiner **Ⓑ** and fingers could be pinched. The hanger bar **Ⓐ** can move suddenly and cause injury.

- ALWAYS keep hands and fingers clear of moving parts to avoid injury.
- When positioning the hoist, be aware of the position of the hanger bar **Ⓑ** and the patient. Injury could occur.



The hanger bar **A** can be installed to the lifting strap carabiner **B** without the use of tools.

1. Pull and hold the retainer **C** up toward the pin **D**.
2. Move the pin and retainer down to open the carabiner **B**.
3. Install the hanger bar **A** onto the carabiner.
4. Release the retainer and pin.
5. Before use, ensure the hanger bar is installed completely onto the carabiner and the retainer is in place, as shown in the figure.

3.3 Before Use

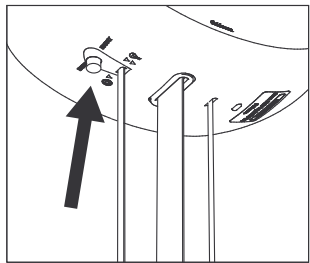

I-Transia is delivered with the emergency stop activated in order to ensure that the battery is not being discharged during long-term storage (more than six months). Reset the emergency stop by pressing the “RESET” button on the bottom of the hoist. Refer to Resetting the emergency stop, page 17.

4 Operation

4.1 Indicator lamps and audio signals

Status	Indicator lamps	Audio signals	Possible I-Transia Functions		
			Up	Down	Emergency Lowering
Off-stand by	Off				
All OK	Green		✓	✓	✓
Low battery	Yellow		✓	✓	✓
Fault on hoist	Yellow	Beeps at button activation			✓
Battery critical low	Yellow			✓	✓
Over load	Green	Beeps at button activation		✓	✓

4.2 Operating the Hoist

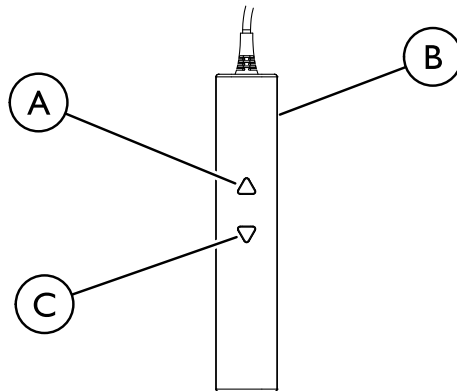

The I-Transia is switched on automatically when a button on the hand control is pressed.

The I-Transia will switch off automatically after approximately 8 minutes of non-operation.

1. Press the UP button (A) on the hand control (B) to lift the patient.
2. Press the DOWN button (C) to lower the patient.



There must be a load on the lifting strap corresponding to the weight of the hanger bar before I-Transia's lowering function will operate.

4.3 Charging the Battery

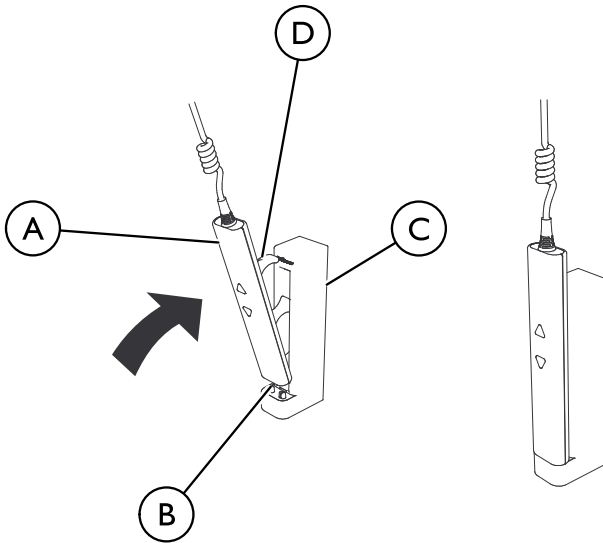

The I-Transia battery charges when the hand control is placed in the charging station.

The indicator lamp on the bottom of the hoist turns yellow if the charge status becomes low. Finish the current lift in progress and charge the batteries when finished.

The hoist is charged when the indicator lamp on the bottom of the hoist is green.

Always leave the hand control in the charging station when the I-Transia is not in use. This guarantees I-Transia functionality and maintains the battery to ensure a long lifetime.

The transformer must be connected and switched on before charging can take place. A green indicator lamp on the transformer indicates it is connected and switched on.

1. Tilt the hand control (A) and place it on the two pins (B) on the charging station (C).
2. Push the rubber handle (D) into the opening on the charging station.



An audible “beep” indicates that the hand control is placed correctly.

4.4 Emergency stop and lowering strap



WARNING!

- If the emergency stop or lowering strap must be used, there is a problem with the system. Contact your Invacare dealer for service before using the system again.

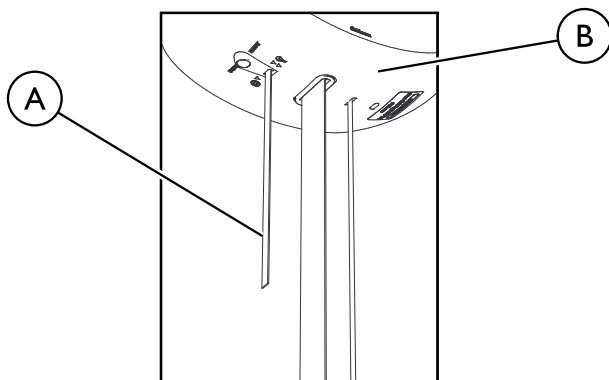

The red strap (A) on the underside of the hoist (B) has the following functions:

- Emergency stop
- Emergency lowering

Emergency stop

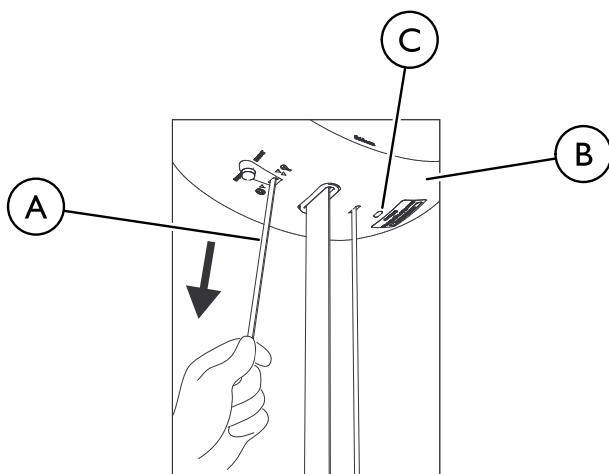

Pull and release the red strap (A) to activate the emergency stop function if the hoist (B) does not stop or react to the hand control during use.



Lifting/lowering functions are deactivated. Emergency lowering will not stop.

The hoist will not function until the emergency stop is reset.

The green lamp (C) will turn off.

Emergency lowering

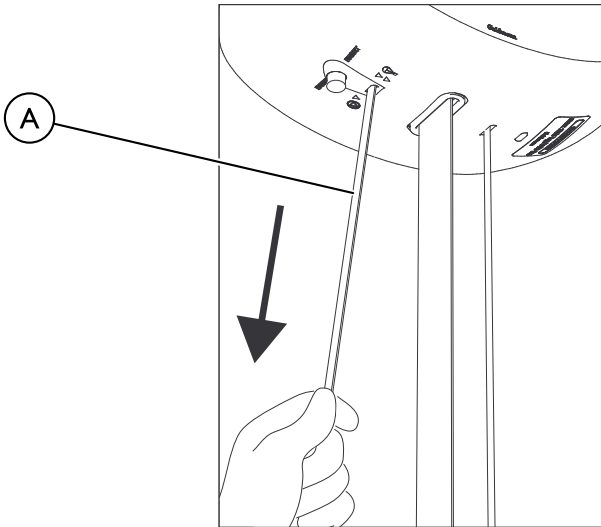

The emergency lowering function is used to lower the patient if the hoist stops working.

1. Pull and hold the red strap **A** to lower the patient.
2. Release the red strap to stop lowering the patient.



The emergency stop feature is activated when the strap is released.

3. If the hoist system needs service, contact your Invacare dealer for service.
4. Reset the emergency stop to resume using the hoist. Refer to Resetting the emergency stop, page 17.

Resetting the emergency stop

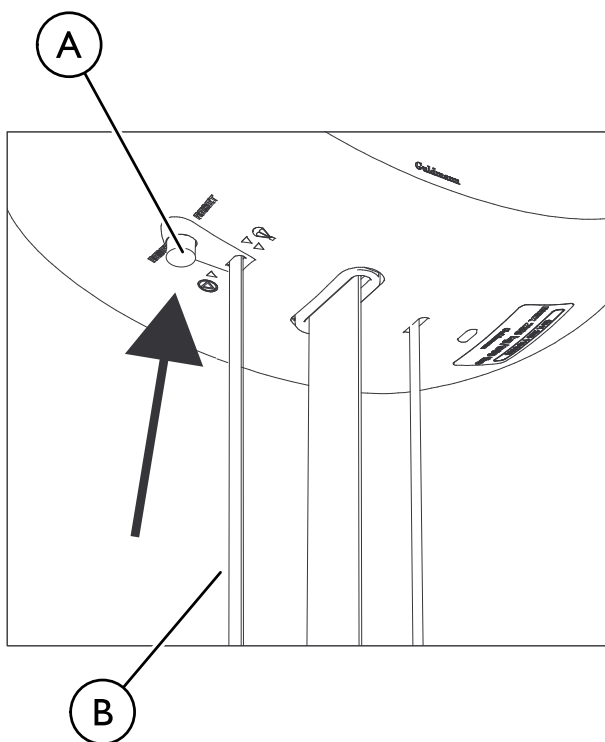

The yellow reset button **A** pops out when the red strap **B** has been pulled. The hoist will not function until the emergency stop is reset.

1. Press the yellow button on the bottom of the hoist to reset the emergency stop or lowering feature.
2. Activate the hand control twice to resume use of the hoist.

5 Lifting the Patient

5.1 Sling Information



WARNING!

Invacare shall not be liable for damage or injury that may occur as a result of using slings made by other manufacturers.

Invacare shall not be liable for damage or injury due to incorrect use of the sling or inadequate attention by the caregiver or user.

- Use the sling that is recommended by the individual's healthcare team for the comfort and safety of the individual that is being lifted. If there is any doubt about the selection or use of a sling, please contact your Invacare dealer.

A sling with four to six lifting straps designed for mounting on hooks should be used when using a Invacare hanger bar.

Refer to the sling user manual for more details about the slings.

UK Customers — Please see the Invacare bulletin concerning slings. A copy can be obtained from Invacare UK — 01656 776222 or uk@invacare.com.

5.2 Attaching the Sling



CAUTION!

Be careful when attaching the lifting sling on the hooks.

- Check that the straps have been positioned completely onto the hooks of the hanger bar.
- When pressing the up button to lift the user, check again that all the straps remain correctly placed in the hanger bar's hooks.

1. Place the uppermost set of straps from the back of the sling on the hooks (A) on the hanger bar (B).
2. Place the lowest set of straps from the legs of the sling on the hooks on the hanger bar.



Refer to the sling user manual for proper positioning of the person in the sling and proper positioning of the straps on the hanger bar.

5.3 Lifting Information



WARNING!

Only personnel who have received training regarding the use of lifting equipment and fitting of slings should use the hoist.

- Plan the move. Avoid leaving the user in the sling unattended.
- The I-Transia lifts quickly. Before lifting, check that the user is completely free of his/her surroundings.
- The user's head, arms, hands and feet must not be in danger of becoming trapped.
- Be careful with any tubes and wires that are attached to the user.
- Check that the red emergency strap, hand control and hand control cable are free of the hanger bar, user and other objects before the hoist is activated and moved up or down.
- When the hoist is used correctly, the user should only be lifted to the extent that she/he is clear of the surface and should be moved at this height.

5.4 Lifting to and from a seated position

Follow this procedure when lifting a person from a seated position (wheelchair, commode, etc.).

1. Move the I-Transia towards the person to be lifted.
2. Position the hanger bar at the same height as the person's chest and no closer than mid-thigh.
3. Position the hanger bar so it is parallel to the person's shoulders.
4. Position the person in the sling. Refer to the sling user manual.
5. Attach the sling to the hanger bar. Refer to 5.2 Attaching the Sling, page 18.

5.5 Lifting to and from a lying position

Follow this procedure when lifting a person from a lying position (in bed).

1. Move the I-Transia towards the person to be lifted.
2. Position the hanger bar over the center of the person.
3. Position the hanger bar so it is parallel to the person's shoulders.
4. Position the person in the sling. Refer to the sling user manual.
5. Elevate the head of the bed, so that the user is sitting up.
6. Attach the sling to the hanger bar. Refer to 5.2 Attaching the Sling, page 18.





6 After Use

6.1 Transport and Storage

Invacare recommends that the I-Transia is always transported and stored in the original packaging.

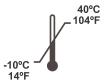
For long term storage, the emergency stop must be activated. Refer to Emergency stop, page 15. This will prevent the discharge of the battery.

The I-Transia should be stored as indicated by the packaging symbols in the table.

Packaging Symbol	Storage Condition
	Temperatures between -10 and +40°C (14 and 104°F)
	Relative Air Humidity between 30 and 70%
	Air Pressure between 700 and 1060 hPa
	This Side Up

6.2 Disposal



WARNING! **Environmental Hazard**

This product has been supplied from an environmentally aware manufacturer that complies with the Waste Electrical and Electronic Equipment (WEEE) Directive 2002/96/CE.

This device contains NiMH batteries.

This product may contain substances that could be harmful to the environment if disposed of in places (landfills) that are not appropriate according to legislation.

- DO NOT dispose of batteries in normal household waste. They MUST be taken to a proper disposal site. Contact your local waste management company for information.
- Please be environmentally responsible and recycle this product through your recycling facility at its end of life.

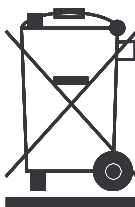

Environmental Policy Statement

Invacare is continuously working towards ensuring that the company's impact on the environment, locally and globally, is reduced to a minimum. It is Invacare's goal to:

- Comply with the current environmental legislation (e.g. WEEE and REACH directives)
- Ensure that we, at the widest possible range, use RoHS compliant materials and components
- Ensure that our products do not have an unnecessary negative impact on the environment regarding use, recirculation or disposal
- Ensure that our products contribute to a positive working environment in the places they are utilised

Inspections are made annually by the Department for Nature and Environment from the Municipality of Aarhus using the Danish Environmental Protection Act, section 42 as a reference.

7 Troubleshooting

7.1 Troubleshooting Table

SYMPTOMS	PROBLEM	SOLUTION
I-Transia hoist does not respond to the hand control's keys.	Emergency stop is activated.	Check that the emergency stop is not activated.
	System does not have power or battery is discharged	Check that the I-Transia has power supply and that the battery is recharged.
		Check that the transformer is switched on and connected to the charging station.
		Place the hand control in the charging station and recharge the I-Transia.
Trolley does not traverse.	Rails require service or cleaning.	Contact an Invacare dealer for service.
Hoist will not charge	System does not have power	Place the hand control in the charging station and recharge the I-Transia
		Check that the power supply is switched on and connected to the charging station.
		Contact an Invacare dealer for service.
No indicator light on hoist	System does not have power or battery is discharged.	Check that the I-Transia has power supply and that the battery is recharged.
		Check that the power supply is switched on and connected to the charging station.
		Place the hand control in the charging station and recharge the I-Transia.
The emergency lowering cord does not turn hoist off	Hoist requires service.	Contact an Invacare dealer for service.
The emergency lowering cord does not lower the hoist.	Hoist requires service.	Contact an Invacare dealer for service.



If problems are not remedied by the suggested means, please contact your Invacare dealer.

8 Maintenance

8.1 Safe Maintenance

**WARNING!**

Regular maintenance of patient lifts and accessories is necessary to assure proper operation.

- Maintenance **MUST** be performed only by a certified technician.

8.2 Maintenance and Safety Inspection

Service Interval

At normal daily operation, a service check-up should take place every year, according to the Safety Inspection Checklist in the Service Manual. When performing annual or regular maintenance, all parts designed to carry load must be, as a minimum, tested with load. All safety features must be checked according to EN ISO 10535:2006 Annex B. This inspection must be performed by a certified technician.

LOLER Statement

The UK Health and Safety Executive's Lifting Operations and Lifting Equipment Regulations 1998, require any equipment that is used in the workplace to lift a load be subject to safety inspection on a six monthly basis. Please refer to the HSE web site for guidance www.hse.gov.uk.

The person responsible for the equipment must ensure adherence to LOLER regulations.

General Maintenance



Follow the maintenance procedures described in this manual to keep your patient lift in continuous service.

The hoist is designed to provide a safe, efficient and satisfactory service with minimum care and maintenance.

It is important to inspect slings, hanger bar, carabiner and lifting strap for signs of cracking, fraying, deformation or deterioration. If damage is found, **DO NOT** use. Contact your Invacare dealer **IMMEDIATELY**.

If you question the safety of any part of the lift, contact your Invacare dealer immediately and advise him/her of your problem.

Replacement of parts must only be performed by a certified technician.

Daily Inspections

The hoist should be checked each time it is used. Perform the following checks in addition to those performed in the annual service inspection. If you question the safety of any part of the lift, DO NOT use. Contact your Invacare dealer IMMEDIATELY.

- Visually inspect the sling, hanger bar and lifting strap. Check all parts for damage or wear. If damage is found, DO NOT use. Contact your Invacare dealer IMMEDIATELY.
- Check the emergency stop and emergency lowering function. Check all parts for external damage or wear. If damage is found, DO NOT use. Contact your Invacare dealer IMMEDIATELY.
- Check that all hardware and attachment points for damage or wear. Check all parts for external damage or wear. If damage is found, DO NOT use. Contact your Invacare dealer IMMEDIATELY.
- Verify that the hand control is functional.
- Check the battery charger.
- Charge the battery every day the lift is used.
- Check the carabiner for wear at the bottom contact point **A**. Do not use the hoist if the carabiner measures less than 6 mm (1/4 in) at this point.

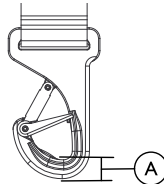

Safety Inspection Checklist

The annual safety inspection checklist is available in the I-Transia service manual.

8.3 Cleaning the Sling and Hoist

Cleaning the Sling

Refer to the washing instructions on the sling and to the sling manual for cleaning details.

Cleaning and Disinfecting the Hoist

To prevent cross-infection, the parts of the hoist that come in contact with caregivers and patients must be cleaned and disinfected.

A soft cloth, dampened with water and a small amount of dish liquid, is all that is needed to clean the hoist, lifting strap and carabiner. The hoist can be cleaned with non-abrasive cleaners.

Never use acids, alkaline or solvents for cleaning the hoist. Dry the hoist carefully after cleaning.

The hoist, hand control and mounting parts can be damaged if the hoist is cleaned any other way than stated above.

The hoist must be wiped with a moistened, firmly wrung cloth with ordinary household disinfectants. Only use disinfection detergents approved by the facility.

9 Technical Data

9.1 Typical Product Parameters

Classification

Class II equipment	<p>Non-permanent installation with out protective ground.</p> <p>Mobile equipment is class II equipment (marked with double-encased symbol) and can be connected to the mains direct by the user.</p> <p>Equipment is disconnected from the supply mains by detaching the mains plug from the wall outlet.</p>
--------------------	--

Flammability

Flammability	This equipment is not suitable for use in the presence of flammable mixtures.
--------------	---

Liquid Ingress

Lifting module	IP 44
Hand control	IP 44
Charging station	IP 20
Power supply	IP 20

Functions

Lifting capacity, Safe Working Load (SWL)	205 kg (450 lb), 250 kg (550 lb)
Operation	Hand control
Sound level	52 dB (A)

Lifting Speed

85 kg (187 lb) load	40 mm/sec. (1.6 in/sec)
150 kg (330 lb) load	40 mm/sec.(1.6 in/sec)
Safe Working Load, SWL	40 mm/sec.(1.6 in/sec)
Max. 5 kg (11 lb) load	80 mm/sec.(3.2 in/sec)

Weight and materials

Safe Working Load (SWL)	205 kg (450 lb), 250 kg (550 lb)
Hoist weight	8.0 kg (17.6 lb)
Covers, top and bottom	Impact-resistant UL 94 V-0 flame retardant recyclable plastic

Dimensions

A	580 mm (22.8 in)	
B	350 mm (13.8 in)	
C	156 mm (6.1 in)	
D	184 mm (7.2 in)	
E, min	83 mm (3.3 in)	
F, min	415 mm (16.3 in)	
G	2500 mm (98.4 in)	
Depth of hoist	194 mm (7.6 in)	

Safety

Emergency stop	Yes
Emergency lowering device	Yes, electrical
Control of lifting strap	Yes
Cut-off angle	45° along the rail, 10° across the rail.

Electronics

On/off	Automatic when used. Soft star/stop
Overload protection	Automatic
Low battery protection	Automatic
Power supply	36 V DC, 0.83 A
Supply voltage, transformer	100–240 V AC, 47–63 Hz
Battery	24 V NiMH, 2.8 Ah
Continuous operation with short time loading with 3 hours without recharging	10/90% (2 min. operation 18 min. pause)
Max number of lifts in series with 85 kg (187 lb)	55/1000 mm
Max number of lifts in series with SWL [205 kg (450 lb), 250 kg (550 lb)]	28/1000 mm
Max charging time at 25°C (77°F)	3 hrs
Operating temperature	10°C — 35°C (50°F — 95°F)

10 Warranty

10.1 Limited Warranty — Europe

Terms and conditions of the warranty are part of the general terms and conditions particular to the individual countries in which this product is sold.

In order to comply with Health & Safety regulations and to ensure that Invacare employees are not exposed to the risk of infection, we must insist that all products returned for repair are thoroughly cleaned. Any product sent to Invacare which appears to be contaminated will be rejected and disposed of immediately at the customer's expense.

10.2 Limited Warranty — North America



PLEASE NOTE: THE WARRANTY BELOW HAS BEEN DRAFTED TO COMPLY WITH FEDERAL LAW APPLICABLE TO PRODUCTS MANUFACTURED AFTER JULY 4, 1975.

This warranty is extended only to the original purchaser/user of our products.

This warranty gives you specific legal rights and you may also have other legal rights which vary from state to state.

Invacare warrants the products manufactured to be free from defects in materials and workmanship for a period of one year from the date of purchase. If within such warranty period any such product shall be proven to be defective, such product shall be repaired or replaced, at Invacare's option. This warranty does not include any labor or shipping charges incurred in replacement part installation or repair of any such product. Invacare's sole obligation and your exclusive remedy under this warranty shall be limited to such repair and/or replacement.

For warranty service, please contact the dealer from whom you purchased your Invacare product. In the event you do not receive satisfactory warranty service, please write directly to Invacare at the address on the back cover, provide dealer's name, address, date of purchase, indicate nature of the defect.

Invacare Corporation will issue a serialized return authorization. The defective unit or parts **MUST** be returned for warranty inspection using the serial number, when applicable as identification within 30 days of return authorization date. Do not return products to our factory without our prior consent. C.O.D. shipments will be refused; please prepay shipping charges.

LIMITATIONS AND EXCLUSIONS: THE FOREGOING WARRANTY SHALL NOT APPLY TO SERIAL NUMBERED PRODUCTS IF THE SERIAL NUMBER HAS BEEN REMOVED OR DEFACED, PRODUCTS SUBJECTED TO NEGLIGENCE, ACCIDENT, IMPROPER OPERATION, MAINTENANCE OR STORAGE, PRODUCTS MODIFIED WITHOUT INVACARE'S EXPRESS WRITTEN CONSENT (INCLUDING, BUT NOT LIMITED TO, MODIFICATION THROUGH THE USE OF UNAUTHORIZED PARTS OR ATTACHMENTS; PRODUCTS DAMAGED BY REASON OF REPAIRS MADE TO ANY COMPONENT WITHOUT THE SPECIFIC CONSENT OF INVACARE, OR TO A PRODUCT DAMAGED BY CIRCUMSTANCES BEYOND INVACARE'S CONTROL, AND SUCH EVALUATION WILL BE SOLELY DETERMINED BY INVACARE. THE WARRANTY SHALL NOT APPLY TO PROBLEMS ARISING FROM NORMAL WEAR OR FAILURE TO ADHERE TO THE INSTRUCTIONS IN THIS MANUAL.

THE FOREGOING WARRANTY IS EXCLUSIVE AND IN LIEU OF ANY OTHER EXPRESS WARRANTIES. IMPLIED WARRANTIES, IF ANY, INCLUDING THE IMPLIED WARRANTIES OF MERCHANTABILITY AND FITNESS FOR A PARTICULAR PURPOSE, SHALL NOT EXTEND BEYOND THE DURATION OF THE EXPRESSED WARRANTY PROVIDED HEREIN AND THE REMEDY FOR VIOLATIONS OF ANY IMPLIED WARRANTY SHALL BE LIMITED TO REPAIR OR REPLACEMENT OF THE DEFECTIVE PRODUCT PURSUANT TO THE TERMS CONTAINED HEREIN. INVACARE SHALL NOT BE LIABLE FOR ANY CONSEQUENTIAL OR INCIDENTAL DAMAGES WHATSOEVER.

SOME STATES DO NOT ALLOW EXCLUSION OR LIMITATION OF INCIDENTAL OR CONSEQUENTIAL DAMAGE, OR LIMITATION ON HOW LONG AN IMPLIED WARRANTY LASTS, SO THE ABOVE EXCLUSIONS AND LIMITATIONS MAY NOT APPLY TO YOU.

THIS WARRANTY SHALL BE EXTENDED TO COMPLY WITH STATE OR PROVINCIAL LAWS AND REQUIREMENTS.

Notes

Notes

United Kingdom	Invacare Limited • Pencoed Technology Park, Pencoed, Bridgend CF35 5AQ • Tel: (44) (0) 1656 776 222 • Fax: (44) (0) 1656 776 220 • www.invacare.co.uk • UK@invacare.com
Ireland	Invacare Ireland Ltd • Unit 5 Seatown Business Campus • Seatown Road • Swords • County Dublin – Ireland • Tel : (353) 1 810 7084 • Fax: (353) 1 810 7085 • www.invacare.ie • ireland@invacare.com
Australia	Invacare Australia Pty Ltd. • 1 Lenton Place • North Rocks • NSW 2151 • Australia • Tel: (61) 2 8839 5333 • Fax: (61) 2 8839 5353 • www.invacare.com.au • sales@invacare.com.au
New Zealand	Invacare New Zealand • 4 Westfield Place • Mt. Wellington • Auckland • New Zealand • Tel: (64) 9 917 3939 • Fax: (64) 9 917 3957 • www.invacare.co.nz • sales@invacare.co.nz
France	Invacare Poirier SAS • Route de St Roch • F-37230 Fondettes • Tel: (33) (0)2 47 62 64 66 • Fax: (33) (0)2 47 42 12 24 • www.invacare.fr • contactfr@invacare.com
Switzerland	Invacare AG • Benkenstrasse 260 • CH-4108 Witterswil • Tel.: (41) (0)61 487 70 80 • Fax.: (41) (0)61 487 70 81 • www.invacare.ch • switzerland@invacare.com
Deutschland	Invacare GmbH • Alemannenstraße 10 • D-88316 Isny • Tel: (49) (0)75 62 7 00 0 • Fax: (49) (0)75 62 7 00 66 • www.invacare.de • kontakt@invacare.com
Portugal	Invacare Lda • Rua Estrada Velha • 949 • P-4465-784 Leça do Balio • Tel: (351) (0)225 1059 46/47 • Fax: (351) (0)225 1057 39 • www.invacare.pt • portugal@invacare.com
España	Invacare SA • c/Areny s/n • Poligon Industrial de Celrà • E-17460 Celrà (Girona)Tel: (34) (0)972 49 32 00 • Fax: (34) (0)972 49 32 20 • www.invacare.es • contactsp@invacare.com
Belgium & Luxemburg	Invacare nv • Autobaan 22 • B-8210 Loppem • Tel: (32) (0)50 83 10 10 • Fax: (32) (0)50 83 10 11 • belgium@invacare.com • www.invacare.be
Nederland	Invacare BV • Celsiusstraat 46 • NL-6716 BZ Ede • Tel: (31) (0)318 695 757 • Fax: (31) (0)318 695 758 • nederland@invacare.com • www.invacare.nl • csede@invacare.com
Norge	Invacare AS • Grensesvingen 9 • Postboks 6230 • Etterstad • N-0603 Oslo • Tel: (47) (0)22 57 95 00 • Fax: (47) (0)22 57 95 01 • www.invacare.no • norway@invacare.com • island@invacare.com
Österreich	Invacare Austria GmbH • Herzog Odilostrasse 101 • A-5310 Mondsee • Tel: (43) 6232 5535 0 • Fax: (43) 6232 5535 4 • www.invacare.at • info@invacare-austria.com
USA	Invacare Corporation Worldwide Headquarters • One Invacare Way • Elyria, Ohio 44036 • Tel: (800) 333 6900 • Fax: (877) 619 7996 • ConsumerCare@invacare.com • www.invacare.com
Canada	Invacare Canada • 570 Matheson Blvd. East, Unit 8 • Mississauga, Ontario L4Z 4G4 • Tel: (800) 668 5324 • Fax: (800) 668 5478 • www.invacare.ca • infocanada@invacare.com

**Manufacturer**

V. Guldmann A/S
Graham Bells Vej 21-23A
DK-8200 Aarhus N, Denmark

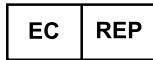
**EU Representative**

Invacare Limited
Pencoed Technology Park
Pencoed, Bridgend CF35 5AQ
United Kingdom

Invacare Corporation**USA**

One Invacare Way
Elyria, Ohio USA
44036-2125
800-333-6900
www.invacare.com



Yes, you can.®

1183377-B 2013-06-26



**Making Life's
Experiences Possible™**

Free Manuals Download Website

<http://myh66.com>

<http://usermanuals.us>

<http://www.somanuals.com>

<http://www.4manuals.cc>

<http://www.manual-lib.com>

<http://www.404manual.com>

<http://www.luxmanual.com>

<http://aubethermostatmanual.com>

Golf course search by state

<http://golfingnear.com>

Email search by domain

<http://emailbydomain.com>

Auto manuals search

<http://auto.somanuals.com>

TV manuals search

<http://tv.somanuals.com>