

ION iAD04

5-Piece Professional Drum Kit

Quick Start Owner's Manual

Manual de inicio rápido del usuario (*ESPAÑOL*)

Schnellbedienungsanleitung (*DEUTSCH*)

Manuale Rapido di Utilizzazione (*ITALIANO*)

Guide d'utilisation simplifié (*FRANÇAIS*)



1

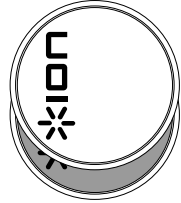
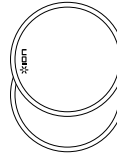
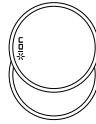
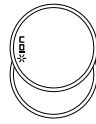
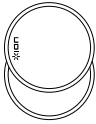
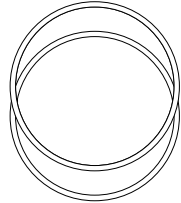
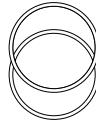
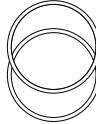
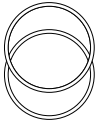
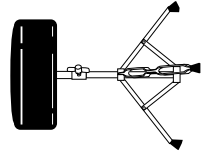
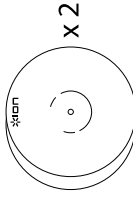
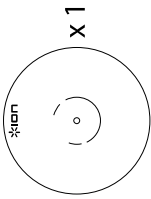
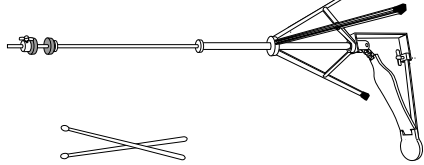
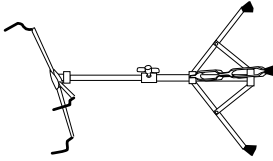
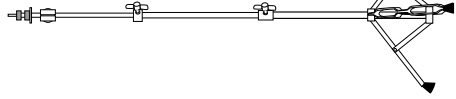

14"

12"

13"

16"

22"

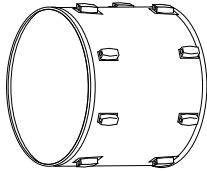
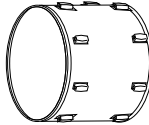
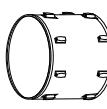

2

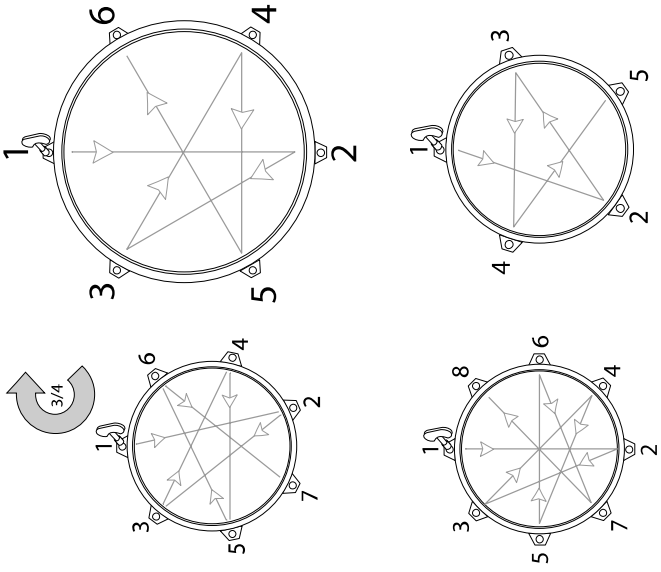
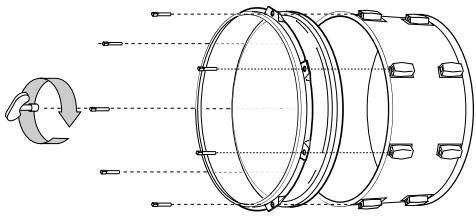
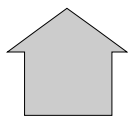
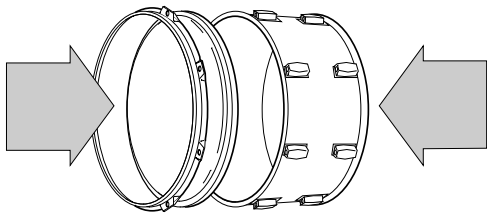

X 5

4

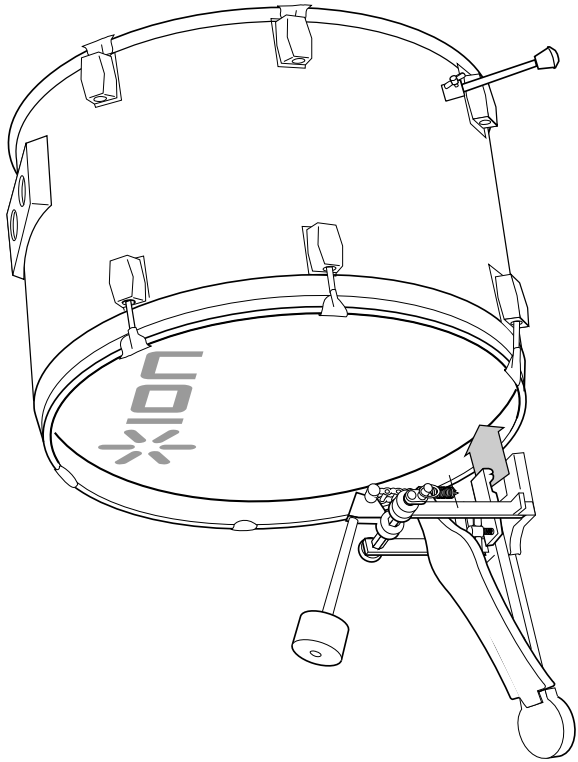

3

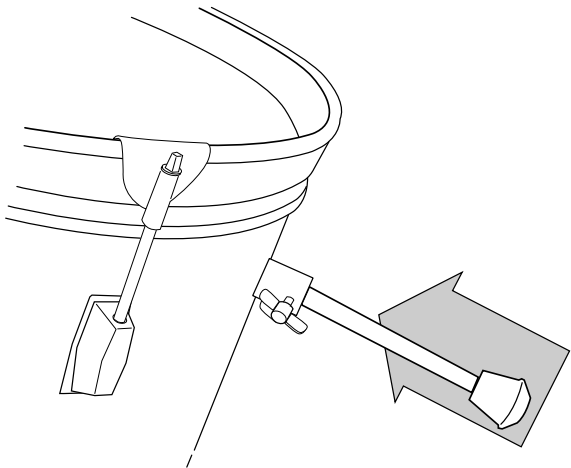

5

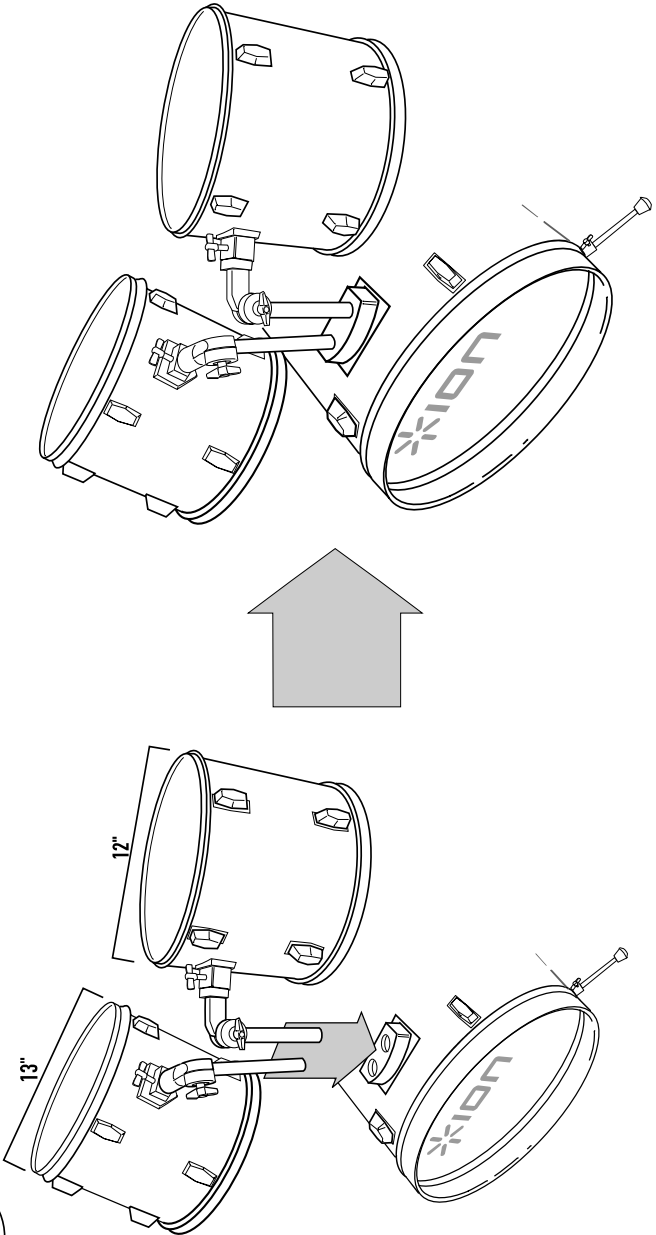

6

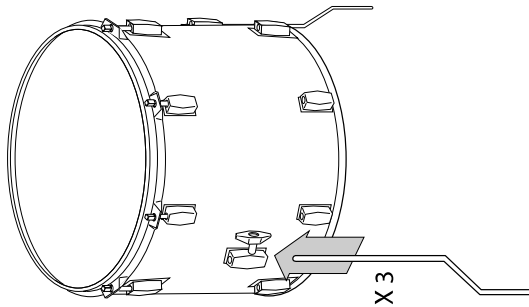

7

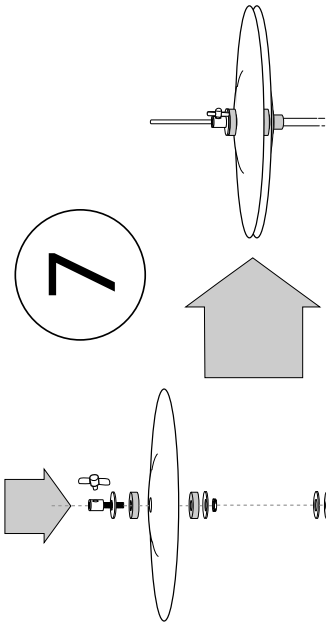

8

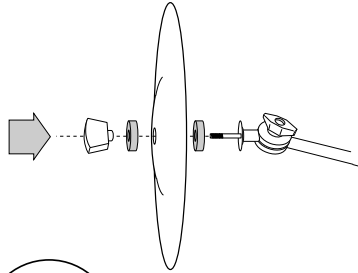

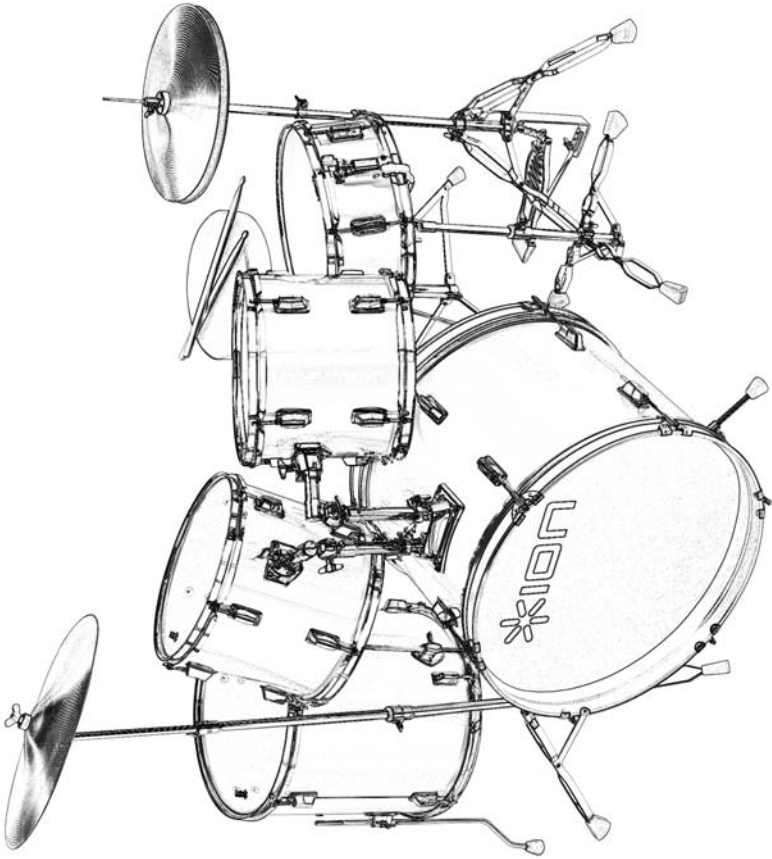

Free Manuals Download Website

<http://myh66.com>

<http://usermanuals.us>

<http://www.somanuals.com>

<http://www.4manuals.cc>

<http://www.manual-lib.com>

<http://www.404manual.com>

<http://www.luxmanual.com>

<http://aubethermostatmanual.com>

Golf course search by state

<http://golfingnear.com>

Email search by domain

<http://emailbydomain.com>

Auto manuals search

<http://auto.somanuals.com>

TV manuals search

<http://tv.somanuals.com>