

**iRiver**

**iFP-800 Series**

[www.iRiver.com](http://www.iRiver.com)



**iRiver**

# Hardware Instruction Manual

**Digital Audio player/  
Recorder/FM Tuner  
Model iFP-800 Series**



**Firmware Upgradable**

Thank you for your purchase.  
Please read this manual carefully  
before using your new player.

[www.iRiver.com](http://www.iRiver.com)

## FCC Certification

---

THIS DEVICE COMPLIES WITH PART 15 OF THE FCC RULES. OPERATION IS SUBJECT TO THE FOLLOWING TWO CONDITIONS:

- (1) THIS DEVICE MAY NOT CAUSE HARMFUL INTERFERENCE, AND
- (2) THIS DEVICE MUST ACCEPT ANY INTERFERENCE, RECEIVED, INCLUDING INTERFERENCE THAT MAY CAUSE UNDESIRE OPERATION.

**Note :** This equipment has been tested and found to comply with the limits for a Class B digital device, pursuant to part 15 of the FCC Rules. These limits are designed to provide reasonable protection against harmful interference in a residential installation.

This equipment generates, uses and can radiate radio frequency energy and, if not installed and used in accordance with the instructions, may cause harmful interference to radio communications. However, there is no guarantee that interference will not occur in a particular installation. If this equipment does cause harmful interference to radio or television reception, which can be determined by turning the equipment off and on, the user is encouraged to try to correct the interference by one or more of the following measures :

- Reorient or relocate the receiving antenna.
- Increase the separation between the equipment and receiver.
- Connect the equipment into an outlet on a circuit different from that to which the receiver is connected.
- Consult the dealer or an experienced radio/TV technician for help.

**NOTE:** THE MANUFACTURER IS NOT RESPONSIBLE FOR ANY RADIO OR TV INTERFERENCE CAUSED BY UNAUTHORIZED MODIFICATIONS TO THIS EQUIPMENT. SUCH MODIFICATIONS COULD VOID THE USER'S AUTHORITY TO OPERATE THE EQUIPMENT.

## Contents

---

<b>GETTING STARTED...</b>	<b>1</b>
<b>LOCATING THE CONTROLS</b>	<b>2</b>
<b>PC SOFTWARE INSTALLATION</b>	<b>3</b>
<b>BASIC OPERATION</b>	<b>4</b>
<b>CONVENIENT FUNCTIONS</b>	<b>5</b>
<b>ADDITIONAL INFORMATION</b>	<b>6</b>

**NOTE** THIS MANUAL COVERS THE INSTALLATION AND USE OF THE PLAYER HARDWARE. FOR DETAILS REGARDING THE SOFTWARE OPERATION INCLUDING TRANSFERRING MUSIC TO THE PLAYER, PLEASE SEE THE SOFTWARE INSTRUCTION MANUAL.

---

---

---

---

---

---

---

---

---

---

---

---

---

---

---

---

---

---

---

---

---

---

---

---

---

**INTERNET** ..... *1-1*

**FEATURES** ..... *1-2*

**ABOUT POWER SUPPLY** ..... *1-3*

**NOTE** THIS MANUAL COVERS THE INSTALLATION AND USE OF THE PLAYER HARDWARE. FOR DETAILS REGARDING THE SOFTWARE OPERATION INCLUDING TRANSFERRING MUSIC TO THE PLAYER, PLEASE SEE THE SOFTWARE INSTRUCTION MANUAL.

- URL : [www.iRiver.com](http://www.iRiver.com)
- Find information on our company, products, and customer and technical support.
- Update your player with firmware downloads. Firmware upgrades offer support for new CODECS and deliver new product features.
- Consult the product FAQ.
- Register your iRiver product online so that our Customer Service is able to provide support as efficiently as possible.
- All contents contained in this manual subject to change without notice to improve ability of this player or according to changing of specification.

iRiver Limited does not assume any responsibility for errors or omissions in this document or make any commitment to update the information contained herein.

iRiver is a registered trademark of iRiver Limited in the Republic of Korea and /or other countries and is used under license. Microsoft Windows Media and the Windows Logo are trademarks or registered trademarks of Microsoft Corporation in the United States and /or other countries.

All other brand and product names are trademarks of their respective companies or organization. All other product names may be trademarks of the companies with which they are associated.

© 1999-2004 iRiver Limited. All rights reserved.

- **Multi-Codec Player**  
Supports MP3, WMA, OGG and ASF formats.
- **Firmware Upgrade**  
Provides the latest updated features via firmware upgrade.
- **Graphic LCD supporting Multiple Languages**  
iFP-800 Series comes with graphic LCD which can support multiple languages (40 languages).
- **FM Function**  
You can easily listen to FM stations and set your favorite stations by using Auto Preset and Frequency Memory functions.
- **6 Preset EQ** : Normal, Rock, Jazz, Classic, U Bass, Metal
- **Xtreme EQ and Xtreme 3D**  
Customize your own EQ with Xtreme EQ and enhance bass and surround sound with Xtreme 3D.
- **GUI (Graphic User Interface) Menu System**
- **Simple Navigation**  
Simple navigation makes it easy to find any song.
- **Supports 8 levels of subfolders, 500 folders total and up to 1500 files at one time.**
- **Create your own playlists.**
- **Direct Encoding**  
11.025KHz ~44.1KHz, 8Kbps ~ 320Kbps
- **Record FM Radio, Voice, or line-in from another device**  
Voice record level is automatically controlled by AGC function.
- **Convenient neck strap.**
- **Supports USB 2.0** (iFP-880 Supports USB 1.1 only)

## ABOUT POWER SUPPLY

### Inserting a battery

1 Open the battery cover.



2 Insert the battery. (AA 1.5V type x 1ea)

Be sure to match the + and - ends of the battery with the diagram inside the battery compartment.



3 Close the battery cover.



※ If the battery is worn out, "Low Battery" is displayed on the LCD. Insert a fresh battery.



Low Battery

#### NOTE

- To avoid corrosion, remove the battery if the player is not to be used for a long time.
- Remove dead battery immediately to avoid damage from corrosion.
- When corrosion occurs, wipe the battery compartment immediately with a dry cloth and insert a new battery.

## Locating the Controls

### Contents

Front View ..... 2-1

Side View ..... 2-2

LCD Screen ..... 2-3

#### NOTE

**THIS MANUAL COVERS THE INSTALLATION AND USE OF THE PLAYER HARDWARE. FOR DETAILS REGARDING THE SOFTWARE OPERATION INCLUDING TRANSFERRING MUSIC TO THE PLAYER, PLEASE SEE THE SOFTWARE INSTRUCTION MANUAL.**

## Locating the Controls

### Front View

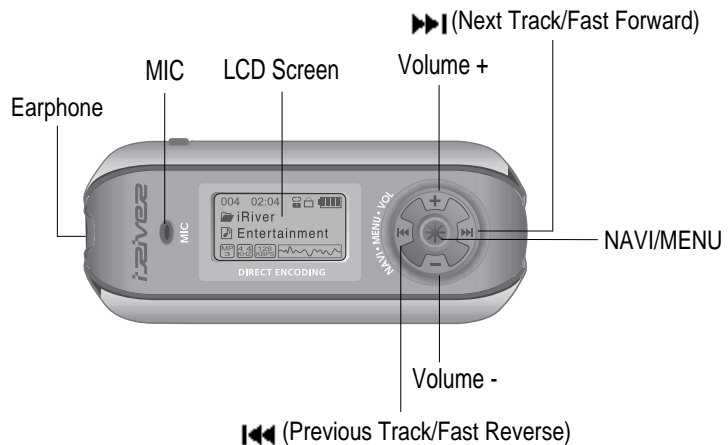

## Locating the Controls

### Side View

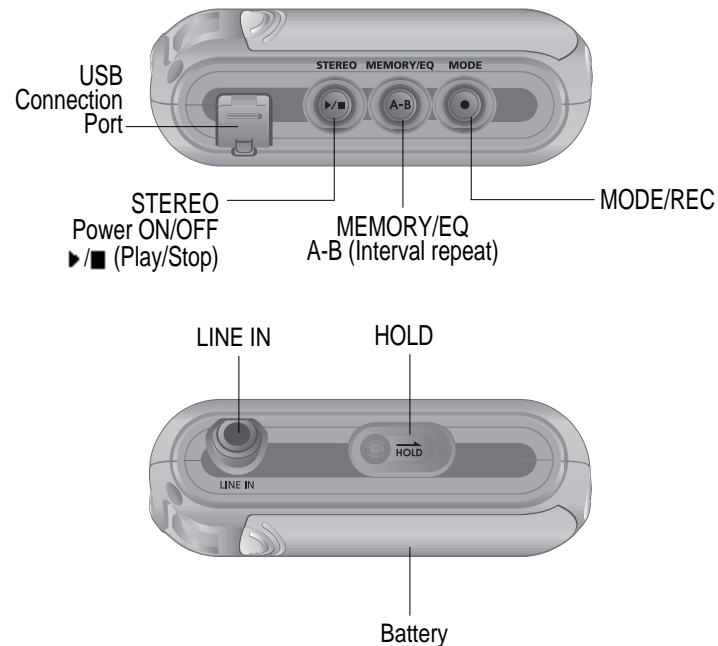

## Locating the Controls

### LCD Screen

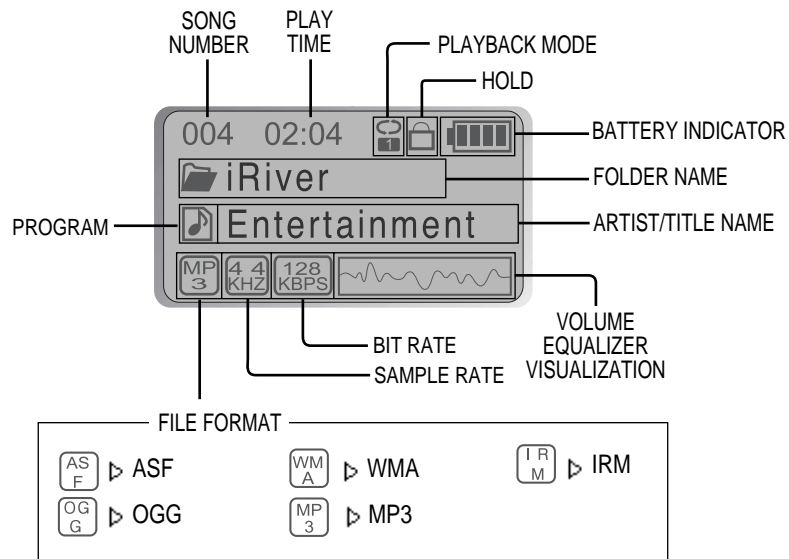

#### ※ IRM (iRiver Rights Management)

iRiver Rights Management is a digital music format. Please visit our web site for details about this music format.

## PC software installation

### Contents

PC software installation	3-1
Attach the player	3-4
Detach the player	3-7

**NOTE** THIS SECTION COVERS THE INSTALLATION FOR WINDOWS OPERATING SYSTEMS ONLY. FOR INSTALLATION INSTRUCTIONS FOR MAC OS, PLEASE SEE THE SOFTWARE INSTRUCTION MANUAL.

**NOTE** THIS MANUAL COVERS THE INSTALLATION AND USE OF THE PLAYER HARDWARE. FOR DETAILS REGARDING THE SOFTWARE OPERATION INCLUDING TRANSFERRING MUSIC TO THE PLAYER, PLEASE SEE THE SOFTWARE INSTRUCTION MANUAL.

## PC software installation

### Software installation

**IMPORTANT** Please complete the steps in this section **BEFORE ATTACHING YOUR PLAYER TO YOUR PC.**

- Insert the Installation CD into the CD-ROM drive.  
The following screen appears after inserting the CD.



- If the installation doesn't automatically begin, execute the "setup.exe" file in the installation CD. The installation program will begin.
- The installation CD contains the following contents :
  - Device Driver
  - iRiver Music Manager
  - Manager Program for Mac

- The player can store MP3 files or files of any type. You can upload files, other than music (MP3, WMA, OGG, ASF), to the PC using the iRiver Music Manager Program.
- Download latest versions of drivers and iRiver Music Manager at [www.iRiver.com](http://www.iRiver.com)
- Please be sure your login has Administrator privileges if using Windows 2000 or Windows XP.

**Note** **System Requirements (Windows)**

- Pentium 133MHz or faster
- USB port
- Window 98SE / ME / 2000 / XP
- CD-ROM drive
- 10MB free hard disk space

## PC software installation

### Software installation

**Note** Please note that the installation screens may differ slightly from those appearing here, as software may be of a more recent version. If your screens differ, please visit [www.iRiver.com/software](http://www.iRiver.com/software) for an updated user guide.

- 1 Insert the Installation CD into the CD-ROM drive. Installation starts automatically.
- 2 Click "Next" after selecting the language to install.



- 3 Click "Next" to Install iRiver Music Manager.



- 4 Select the folder to Install. Click "Next".

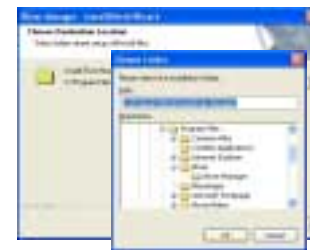



## PC software installation

### Software installation

- 5 Click "Next" after confirming the installation folder.



- 6 Click "Install" to begin the installation.



- 7 Installation is in progress. Click "Finish" after the installation is completed.



## Attach the player

### Connecting to the PC

- 1 Connect the USB cable (provided) to the USB port of your computer.

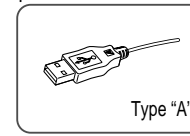
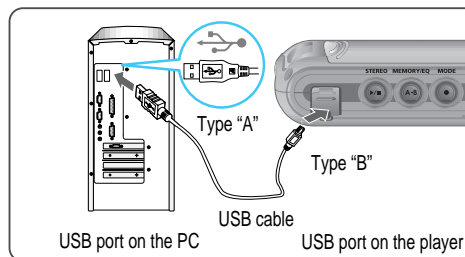

Type "A"

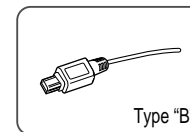

Type "B"

- 2 Turn on the player by pressing the button marked STEREO. Lift the protective cover over the USB port and connect the USB cable to the player.
- 3 "USB CONNECTED" will appear on the LCD screen of the player.

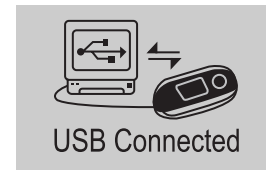

- Note**
- Connect the USB cable to the PC after playback stops to avoid errors.
  - iFP-880 supports USB 1.1 (Full speed) and iFP-890/ 895/ 899 supports USB 2.0 (High speed) version.

## Attach the player

### Installation of "New Hardware"

- 1 After installing iRiver Music Manager from the CD and connecting the player to your PC, "Found New Hardware" screen is displayed.



- 3 Select "Install the software automatically (Recommended)" and click "Next".



- 2 The computer will automatically search to find your new hardware.



- 4 If a "Hardware Installation" warning message appears, click "Continue Anyway". (Windows XP)  
The iRiver software driver will not cause any damage to your computer.



## Attach the player

### Installation of "New Hardware"

- 5 The installation will continue.



- 6 Click "Finish" Completed the installation of "New hardware".



- 7 Information screen is displayed on the PC. New hardware is installed successfully and ready to use.

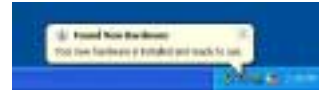

#### Note

- Windows 98SE, Windows ME, Windows 2000 O.S do not need any other device driver installation.
- Install New Hardware after installing iRiver Music Manager program.

## Detach the player

### Safely Removing the player from the PC

- 1 Select the "Safely Remove hardware" after clicking the "Safe To Remove Hardware" by using the right button of mouse.
- 2 Click the "Stop" after selecting the device to remove.



- 3 Click the "OK" after confirming the hardware to remove.
- 4 Click the "Close" after confirming the Safely Remove Hardware message. (In case of Windows XP)

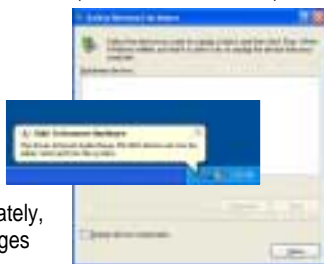

✳ If the player is disconnected inaccurately, it may cause a malfunction or damages to the player.

## Basic Operation

### Contents

Listening to Music	4-1
Basic Operation	4-3
Operating the FM Tuner	4-7
Recording	4-11

## Listening to Music

### LISTENING TO MUSIC

- Connect the earphones as shown below.
- Put the HOLD switch to "OFF".



- Press the PLAY/STOP button to turn on the player. Press it again to play.



- To select song
  - To select previous song
  - To select next song



- To adjust the volume
  - + : To increase volume
  - : To decrease volume



#### NOTE

- When "Hold" is ON, the buttons on the player will not function.
- When stopped or in recording standby mode, the player automatically turns off according to the setting of "STOP POWER OFF" on the MENU. (Refer to page 4-17)

## Listening to Music



- To turn on the player



- To play



- To change modes (MP3  $\leftrightarrow$  FM  $\leftrightarrow$  Voice recording  $\leftrightarrow$  LINE IN)



- To stop



- To advance



- To reverse



- To play the next folder



- To play the previous folder

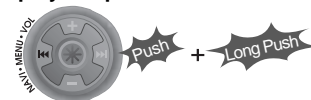

- To fast forward



- To fast reverse



- To turn off the player



## Basic Operation

### Basic Operation

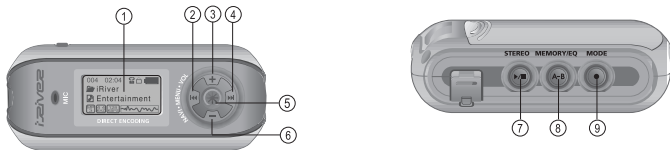

1. LCD window : Displays the operating status of the player.
2. To skip to previous track or previous FM station.
3. To increase volume.
4. To skip forward to the next song or FM station.
5. To select NAVI/MENU function.
6. To decrease volume.
7. To Play or Stop playback, to select FM mode, or to turn on/ off.
8. To select EQ mode, A-B repeat, or automatically store FM stations.  
EQ : NORMAL → ROCK → JAZZ → CLASSIC → U BASS → METAL → Xtrm EQ → Xtrm 3D
9. To select function, playback mode, or record/stop recording.

### Navigation



### Menu



## Basic Operation

### Changing Functions

Press and hold the MODE button to display the current function. Push the NAVI/MENU button toward |◀◀ or ▶▶| to select the desired function, then click the NAVI/MENU button to enter that mode.

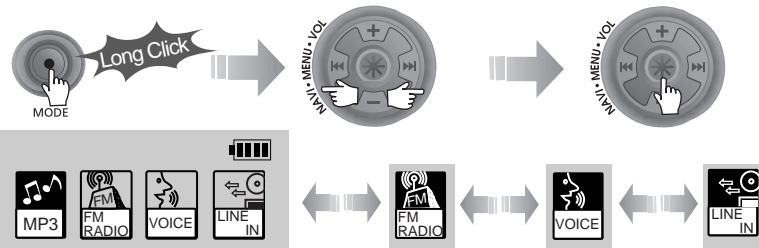

• MP3 Playback ↔ FM Receiving ↔ Voice Recording ↔ LINE IN Recording

### Selecting FM Tuner Mode

Press the STEREO button to select STEREO or MONO.



(Refer to page 4-8)

### adjusting the volume

Press + on volume button to increase volume and press – on Volume button to decrease volume.

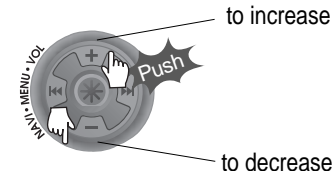

## Basic Operation

### NAVIGATION

Press **NAVI/MENU** button and find the desired track by pushing the VOL + or VOL - button. To select the track, press the **NAVI/MENU** button, **▶▶** or the  button.

To move to the upper folder, push the **◀◀** switch. If there is no upper folder, NAVIGATION stops.

### MODE

During MP3 playback, you can select the playback mode by turns by clicking the MODE/REC button.



Press and hold the MODE/REC button : You can select MP3 or FM, Voice or Line-in recording functions. (Play mode is automatically activated when MP3 is selected).

### MENU



A long press of the **NAVI/MENU** button will enter the menu system.

- 1 Scroll between menus : Push **◀◀** or **▶▶** (VOL + or VOL -).
- 2 Exit : Click the PLAY/STOP button (or long pressing of **NAVI/MENU** button).
- 3 Select Function: Press the **NAVI/MENU** button.



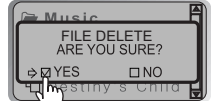

## Basic Operation

### DELETING FILES ON THE PLAYER

- 1 Stop playback. 
  - 2 Press the "NAVI/MENU" button. 
  - 3 Select the file to delete by using VOL + or VOL -.
- 
- 
- 4 Click the "MODE" button. "FILE DELETE ARE YOU SURE?" is displayed on the screen. Select "YES" by using **◀◀** or **▶▶** (VOL + or VOL -) to delete. Then click NAVI/MENU button.

### DELETING FOLDERS ON THE PLAYER

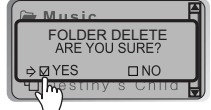
- 1 Stop playback. 
  - 2 Press the "NAVI/MENU" button. 
  - 3 Select the folder to delete.
- 
- 
- 4 Click the "MODE" button. "FOLDER DELETE ARE YOU SURE?" is displayed on the screen. Select "YES" by using **◀◀** and **▶▶** (VOL + or VOL -) to delete. Then press NAVI/MENU button.

**NOTE** You can only delete an empty folder.

## Operating the FM Tuner

### OPERATING THE FM TUNER

- 1 To switch to the FM Tuner, press and hold the **MODE/REC** button. The current function is displayed.



The function selection graphic displays on the LCD. ▶



- 2 Push the **◀◀**, **▶▶** switch to select **FM RADIO**. Press the **NAVI/MENU** button to confirm.

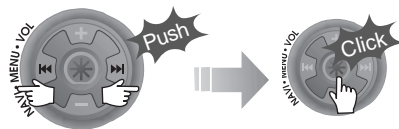

- 3 Push the **NAVI/MENU** switch toward **◀◀** or **▶▶** to select your desired station.



(Ex : 87.5 → 87.6)

## Operating the FM Tuner

### To select STEREO/MONO

- ▶ Press the **STEREO/PLAY/STOP** button to select Stereo/Mono.



### Auto Scan function

To automatically locate a station press and hold **NAVI/MENU** button to the right or left. The player will quickly scan through each frequency and stop at the next station that can be tuned in.



### PRESET Mode

To select a station saved in memory, press the **NAVI/MENU** button to enter PRESET mode then find a saved station by pushing the **◀◀** or **▶▶** switch to the left or the right.

(Ex : 89.1 → 91.9 → 93.1)

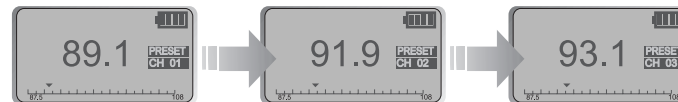

## Operating the FM Tuner

### Memory Function (Save stations)

1 Select a station by pushing the or switch to the left or the right.

2

MEMORY/EQ Click

91.9 MEMORY CH 01

91.9 MEMORY CH 02

again MEMORY/EQ Click

Save complete

To cancel Saving Click will exit the memory function without saving.

3 Up to 20 stations can be saved.

### Auto memory function

Press and hold the A/B MEMORY button to automatically select stations and save them in sequential order.

(Only activates while the player is not in PRESET mode)

- Auto memory may not work within weak transmission areas.



## Operating the FM Tuner

### Memory delete function (Delete saved stations)

1 Select the station to be deleted at PRESET mode

2 Press and hold the MEMORY button.



- The next station will appear when station delete is completed. Push the MEMORY button if you also want to delete the next station.

#### NOTE

- FM Tuner reception may vary in different areas.
- While in PRESET mode, auto scan and auto memory functions are not available.
- When the player doesn't have any preset stations, EMPTY will be displayed at PRESET mode then faded out.

### To turn the player off

Press and hold the PLAY/STOP button to turn the player off.





## Recording-FM Tuner

### To record FM

Press the MODE/REC button during FM reception. The station will be recorded, the remaining recording time will be displayed on the LCD screen.



### To pause FM recording

Press PLAY/STOP button to pause the recording process. Press PLAY/STOP button again to restart recording.



### To stop FM recording

Press the MODE/REC button again to stop recording. The recorded file is saved as TUNER000.REC. It is saved in the RECORD folder.

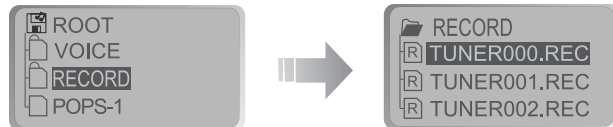

### To play a recorded file

After selecting MP3 mode, select the recorded file to listen and press the PLAY/STOP button to play.

- NOTE**
- Volume can not be controlled while recording.
  - Recorded REC files can be converted to MP3 files using iRiver Manager. (Refer to page iRiver Music Manager Software Instruction Manual 32~34/37~39)

## Recording-Voice

### Recording Voice

1 Press and hold the MODE/REC button.



2 Press the <<< or >>> (VOL + or VOL -) switch to select Voice mode.



3 Press the NAVI/MENU button (or PLAY/STOP) to go to Voice recording mode. (The recorder will be in standby mode.)



4 Press the MODE/REC button again to begin recording.



## Recording-Voice

### To stop recording

Press the MODE/REC button.



#### NOTE

- After stopping a recording, starting again will create a new voice file.

#### NOTE

- The recorded file is saved as VOICE000.REC in the VOICE folder.
- If "00:00:00" is displayed on the LCD, the player's memory is full. To record, delete files and/or folders on the player to make some space available. (To delete : Refer to page 4-6, iRiver Music Manager)
- The player can not record when the memory is full or the battery is low.
- Keep the player far away enough from the source to avoid distortion in the recording.
- Recorded REC files can be converted to MP3 files using iRiver Manager. (Refer to page iRiver Music Manager Software Instruction Manual 4-32~4-34)

### To play a recorded file

Press the PLAY/STOP button.



### To pause voice recording

Press ►/■ button during recording.  
Press ►/■ button again to restart recording.

#### NOTE

- Pausing the recording will not create a new file, recording will be added to the current recording.

## Recording-External audio source

### Recording from an external audio source

- Connect the LINE OUT jack of the external equipment to the LINE IN jack of the player.

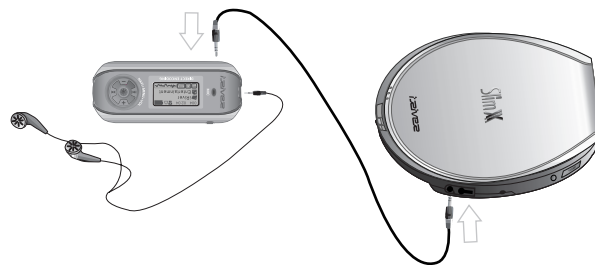

- Set "LINE IN RECORDING MODE" in the MENU.(Refer to page 5-22 for details)



#### NOTE

- Select Line-In mode on the menu to use the external microphone.

- Press and hold the MODE/REC button.



## Recording-external audio source

### Recording from an external audio source

- 4 Press the (VOL + or VOL -) switch to select the LINE-IN mode.



- 6 Press the MODE/REC button and LINE-IN recording is started.



- 5 Press the NAVI/MENU button (or PLAY/STOP) to go to LINE-IN recording mode. (Record Standby Mode)



- 7 Press play on your external equipment (if necessary) to begin playback to be recorded.

#### NOTE

- The recorded file is saved as AUDIO000.REC, AUDIO001.REC... in sequential order. Files are saved in the RECORD folder.
- Select Ext. Mic on the CONTROL line-in/ext. mic menu to use the external microphone. (Refer to page 4-23)
- Files recorded using an external microphone are saved as EXMIC000.REC.

## Recording-external audio source

### To stop recording

- 1 Press the MODE/REC button.



### To play a recorded file (1)

- 1 Press the PLAY/STOP button.



### To play a recorded file (2)

- 1 After pressing the NAVI/MENU button, select a recorded file using the VOL + or VOL - switch.



- 2 Press the PLAY/STOP button.



---

---

---

---

---

---

---

---

---

---

---

---

---

---

---

---

---

---

---

---

---

---

---

---

**Contents**

<b>NAVIGATION (SEARCHING)</b>	5-1
<b>PLAYBACK MODE</b>	5-3
<b>PROGRAM MODE</b>	5-5
<b>EQ MODE</b>	5-8
<b>MENU</b>	5-9
<b>Basic Operation</b>	5-10
<b>General</b>	5-12
<b>Display</b>	5-14
<b>Timer</b>	5-17
<b>Control</b>	5-20
<b>Mode</b>	5-24
<b>Name</b>	5-26
<b>Sound</b>	5-27

## Navigation (Searching)

### Navigation

Navigate to locate tracks to play.



You can select a song by pressing the NAVI/MENU button and using the VOL +, VOL - switch.

1 NAVI/MENU button

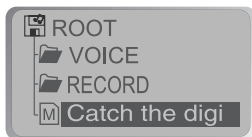

2

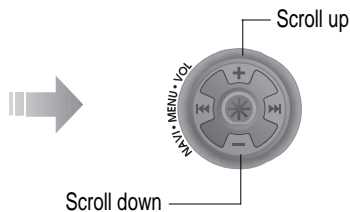

## Navigation (Searching)

### Navigation

3 Select folder or scroll to upper folder



Select the upper folder

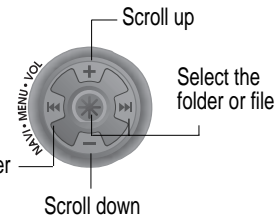

Select the folder or file

4 Select the track

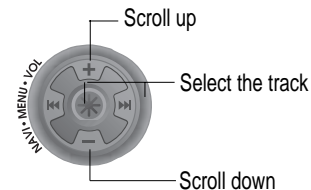

Select the track



### IRM (iRiver Rights Management)

iRiver Rights Management is a digital music format.  
Please visit our web site for details about this music format.

## MODE (Playback Mode)

### MODE (Playback Mode)

You can set various Repeat and Shuffle options by choosing these selections under Mode. Change the Repeat or Shuffle mode by pressing the MODE button. Please refer to the MODE function controls (page 5-24) for user-defined configuration.

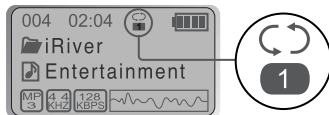

▲ When the MODE/REC button is pushed, the icon in the playback mode indicator is changed.

### REPEAT

	Play a single track repeatedly.
	Play all tracks in the folder and stop.
	Play all tracks in the folder repeatedly.
	Play all tracks in the player repeatedly.

### SHUFFLE

SFL	Randomly play all tracks in the player and stop.
SFL	Play a single track repeatedly. Skip forward will select a new random track to play repeatedly.
SFL	Randomly play all tracks in the folder and stop.
SFL	Randomly play all tracks in the folder repeatedly.
SFL	Randomly play all tracks in the player repeatedly.

## MODE (Playback Mode)

### INTRO

- INTRO:** Plays the beginning 10 seconds of each track in sequential order.
- INTRO HIGHLIGHT:** Plays 10 seconds from 1 minute into each track in sequential order. You can set this function in the MENU function. (Refer to page 5-25)

### Interval Repeat(A-B)

Repeat a selected interval.



Press the button once to select the beginning <A> point.



Press the button again to select the ending <B> point.

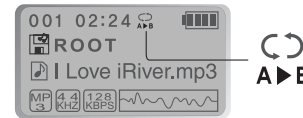
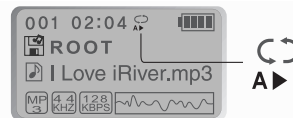

▲ A-B interval will be repeated.

## Program Playback

### Activating Program mode

You can listen to your favorite songs by using Program Mode.

#### 1 Click the MEMORY/EQ button at Stop playback.

The program list is displayed. If the player has been programmed already, the current program list will display.



▼ Scroll to PROGRAM mode

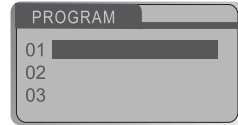

#### 2 Push the VOL +, VOL - switch to select the number to be programmed.

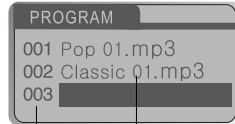
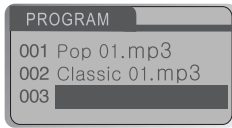

Numbers of program list      Music name

## Program Playback

### Activating Program mode

#### 3 Press the NAVI/MENU button once and navigate to the desired track. Press the NAVI/MENU button again to save that track to the program list.



#### 4 Press the MEMORY/EQ button to save the program list.

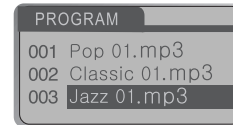

#### ■ To save all files in the folder as the program list

After selecting a folder to save, then press the MEMORY/EQ button to save all files in the folder. Sub folders are not added.

### Program Playback

After programming, press PLAY/STOP button to play the tracks in sequential order.

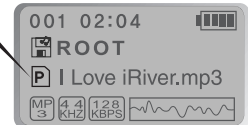

The PROGRAM mode icon appears

## Program Playback

### To remove files from the program list

Press the MODE/REC button after selecting the file to be deleted using the MEMORY/EQ button. The program list is automatically changed.

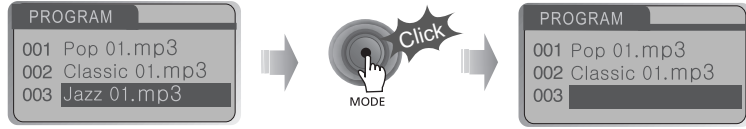

To delete all programmed songs, press MEMORY/EQ button for several seconds.

### Cancel Program Mode

Push the NAVI/MENU button toward VOL - at Stop mode. Program playback is cancelled and normal playback is started.

In Stop Mode



## EQ Mode

### EQ MODE

You can select EQ mode in accordance to the playing music genre.

Press and hold the MEMORY/EQ button to display the current EQ setting. Then press the button repeatedly to chose a different EQ.

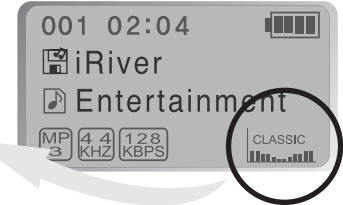
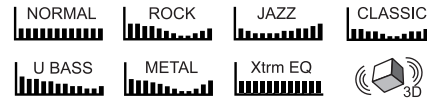
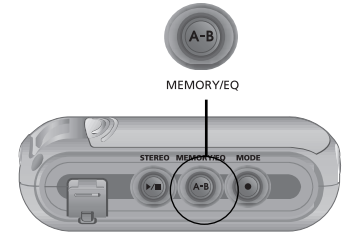

#### NOTE

Xtrm EQ and 3D are set in the MENU, refer to page 5-27 through 5-29 for details.

#### CAUTION

You can select your favorite EQ as the set value on the EQ SELECT menu. The set value on the menu is saved but EQ mode is not changed in case of not selecting Xtreme EQ and Xtreme 3D.



## Configuration



Functions are subject to change with different firmware versions. Users can configure their own settings.

### GENERAL

- ▣ resume
- ▣ language
- ▣ load default

### DISPLAY

- ▣ back light
- ▣ lcd contrast
- ▣ visualization
- ▣ scroll speed
- ▣ tag information
- ▣ play time information
- ▣ battery select

### TIMER

- ▣ sleep Power Off
- ▣ stop Power Off
- ▣ set Time
- ▣ alarm/Record Select
- ▣ set Alarm
- ▣ tuner Rec. Reservation

### CONTROL

- ▣ fast skip
- ▣ scan speed
- ▣ voice recording mode
- ▣ voice auto detection
- ▣ tuner recording mode
- ▣ line-in recording mode
- ▣ line-in recording volume
- ▣ line-in auto-sync
- ▣ line-in/ext. mic

### MODE

- ▣ repeat
- ▣ shuffle
- ▣ intro
- ▣ study
- ▣ name

### SOUND

- ▣ Xtreme EQ
- ▣ Xtreme 3D
- ▣ DBE setting
- ▣ 3D EQ setting
- ▣ sound balance
- ▣ eq limit
- ▣ eq select
- ▣ beep volume
- ▣ fade in

## Basic Operation

- Press and hold the NAVI/MENU button to display the MENU system.
- The MENU system is composed of 6 main menus with sub-menus.

### MAIN MENU



### SUB MENU

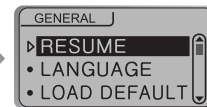

### Window for SUB MENU SETTING

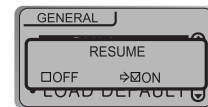

## To select Main Menu

### Shift between Menus

Push the ◀◀◀ or ▶▶▶ switch to move between main menu and sub menu.



### From Main Menu to Sub Menu

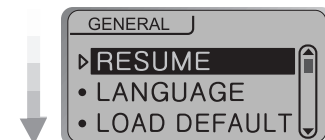
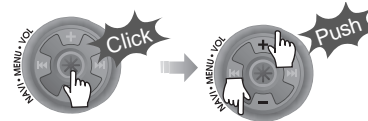

## MENU-Basic Operation

### To select Sub Menu

#### • Enter Sub Menu



You can set, cancel or change Sub Menu by pressing the NAVI/MENU switch toward  $\leftarrow$ ,  $\rightarrow$  or VOL +, VOL -.

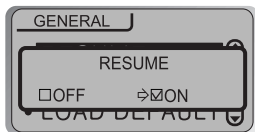

### Exit Sub Menu

Click the PLAY/STOP button to return Main MENU at the sub-menu setting.



### Exit Main Menu

Click the PLAY/STOP button to exit Main Menu.



## MENU-General

### GENERAL

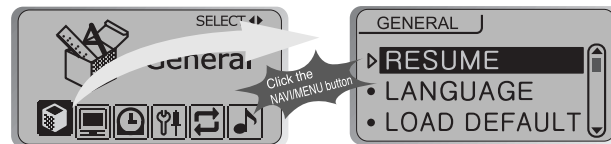

### Resume

**ON** : Playback resumes from the previous location in a song when the player is stopped or powered off.

**OFF** : Playback begins from the first track after the player is stopped or powered off.

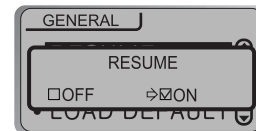

### LANGUAGE (Supports 40 languages)

#### • Supports 40 languages

Song title and ID3 tag information for the MP3 files is dependent on the version of the PC operating system that was used to create it. (For example, if an MP3 file is created in an English version of Windows, the language setting should be English for the proper title display)

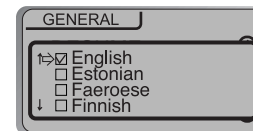

## MENU-General

### Load Default Value

Initialize Menus to the original factory settings.  
Button operation order is as below.  
Click NAVI/MENU (select default menu) → **⏪** or **VOL +**  
(select YES) → Click NAVI/MENU (select YES : Initialization)

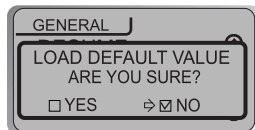

## MENU-Display

### Display

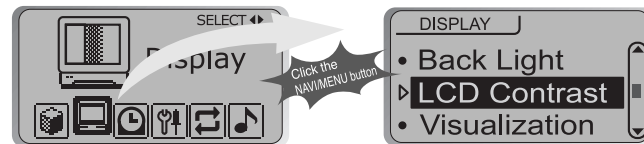

### Back-Light

You can adjust the time that the Backlight stays on.  
SEC : Backlight stays on from 0 to 30 seconds.  
MINUTE : Backlight stays on from 0 to 30 minutes.  
Press the NAVI/MENU button to set SEC/MINUTE.



### LCD Contrast

Adjust the LCD screen contrast.

Contrast can be adjusted by using the **⏪** or **⏩** (VOL + or VOL -) buttons.

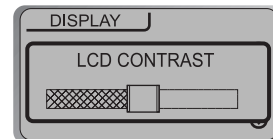

## MENU-Display

### Visualization

During playback, you can display visualizations, the elapsed time of the track, or the free memory on your player.

- WAVEFORM 
- LEVEL METER 
- PROGRESSIVE  65%
- FREE SPACE  30M
- CLOCK  HH:MM AM/PM

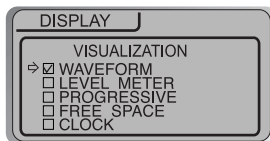

### Scroll Speed

Adjust scroll speed by 1x/2x/4x/Vertical/Horizontal.  
Vertical : The scroll goes up and down  
Horizontal : The scroll goes from the left to the right.

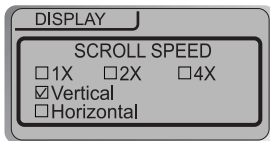

### Tag Information

ON : Display track with ID3 tag information  
OFF : Display track with file name

\* File name will be displayed by default for songs with no ID3 information.

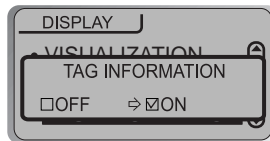

## MENU-Display

### Playtime Information

NORMAL : display elapsed time.  
REMAIN : display remaining time.

Note : Time display may not be accurate for files encoded in Variable Bit Rate formats.

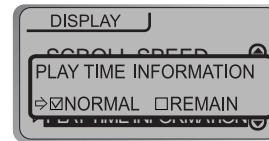

### BATTERY SELECT

Select the current battery.

The player will manage the battery indicator icon to better match the usage level.

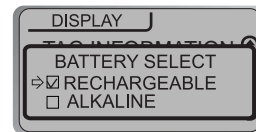

## Timer

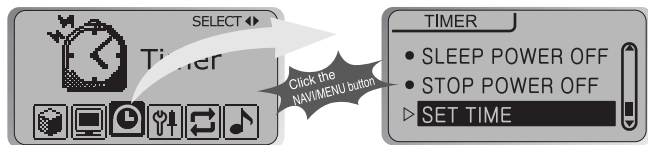

## Sleep Power Off

Automatically turns power off after a fixed time. (Time range can be set from 1 to 180 minutes by one minute increments.)

Use the  $\leftarrow$  or  $\rightarrow$  (VOL + or VOL -) button to adjust time. Set BEEP ON/ OFF by pressing the NAVI/MENU button.

### Beep

ON : A beep sound will play one minute before the player shuts off.

OFF : No beep sound is played.

▷ Once powered off, the sleep timer will reset to 0.

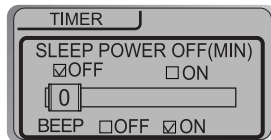

## Stop Power Off

Automatically turns power off at stop mode. (Time range can be set from 1 to 60 minutes by one minute increments.)

Use the  $\leftarrow$  or  $\rightarrow$  (VOL + or VOL -) button to adjust time.

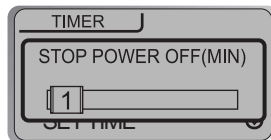

## Set Time

### Set the current time.

Push the NAVI/MENU switch toward  $\leftarrow$  or  $\rightarrow$  to select the item and toward VOL + or VOL - to set the clock.

Use the  $\leftarrow$  or  $\rightarrow$  switch to adjust time.



## Alarm/Record Select

OFF : The Alarm and Tuner Record functions are disabled and the player will not power on at either indicated time.

ALARM : At the time indicated in the "Set Alarm" setting (see below) the player will power on and begin music playback.

TUNER RECORD : At the time indicated in the "Tuner Rec. Reservation" setting (see page 5-19) the player will power on and begin recording from the selected radio station.

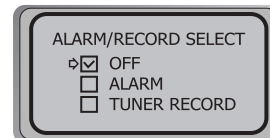

## Set Alarm

### Set the working time of alarm.

Push the NAVI/MENU switch toward  $\leftarrow$  or  $\rightarrow$  to select the item and toward VOL + or VOL - to set the alarm.

SUN ~ SAT : Alarm rings in the same time of the set day repeatedly.

ALL : Alarm rings in the set time every day.



## Tuner Rec. Reservation

**Set the time and station to be recorded.**

Push the NAVI/MENU switch toward **I◀◀** or **▶▶I** to select the item and toward **VOL +** or **VOL -** to set the recording time.

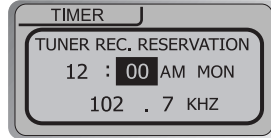

SUN ~ SAT : Tuner recording is started at the same time of the set day repeatedly.  
ALL : Tuner recording is started at the set time every day.

## Control

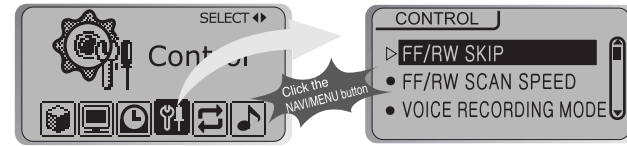

## Fast Skip

OFF : Skip doesn't activate.  
10 : Skip 10 tracks at time.  
DIRECTORY : Skip to previous or next folder.

This defines the operating method of short or long click of **I◀◀** or **▶▶I** lever.



## FF/RW Scan Speed

The fast scan speed can range from 1x/ 2x/ 4x/ 6x.

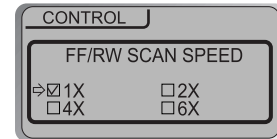

## MENU-CONTROL

### Voice Recording Mode

You can adjust recording quality when recording Voice.

Bit Rate : 8Kbps~160Kbps

Sampling Frequency : 11.025KHz ~44.1KHz

**AGC ON** : When recording voice, the recording level is automatically controlled and the sound from a long distance is normally recorded.

**AGC OFF**: AGC Control not activated.

**NOTE** AGC :Automatic Gain Control



### Voice Auto Detection

The voice recording mode will automatically pause during silence. This is useful for recording over a long period of time to save memory.

**OFF** : Voice Auto Detection is disabled.

**Voice Auto Detection (first slider)** : Set the relative level of sound needed to activate the recorder. (Level 1-10).

**Record pause time (second slider)** : Set the number of seconds of silence to record before pausing. (1-10 Sec)

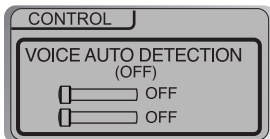

### TUNER RECORDING MODE

You can adjust recording quality when recording from the FM Tuner.

Bit Rate : 8Kbps~320Kbps

Sampling Frequency : 11.025KHz ~44.1KHz



## MENU-CONTROL

### LINE-IN RECORDING MODE

You can adjust recording quality when recording from external equipment.

Bit Rate : 8Kbps~320Kbps

Sampling Frequency : 11.025KHz ~44.1KHz



### LINE-IN RECORD VOLUME

You can adjust recording level when recording from External equipment.  
(You can set from 0 to 64.)



### LINE-IN AUTO-SYNC

Line-In, a new file will be created for each track on the CD automatically.

- **OFF** : Audio signal detection is disabled.
- **Audio signal detection time (1-5 seconds)** : The amount of silence the player will use to determine when a track has ended and to start a new file.

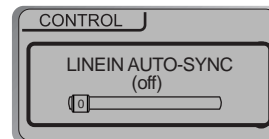

## MENU-Control

### Line-in/Ext. Mic

You can select external microphone or line-in when recording.

Line-In : To record through Line-In

Ext. Mic : To record through an external microphone

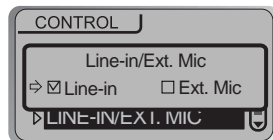

- NOTE**
- To record from an external microphone, chose the LINE-IN recording mode (see page 5-14, 5-15).
  - The recording quality level will be set to the values chosen for LINE-IN recording (see page 5-22).

## MENU-Playback Mode

### Playback Mode

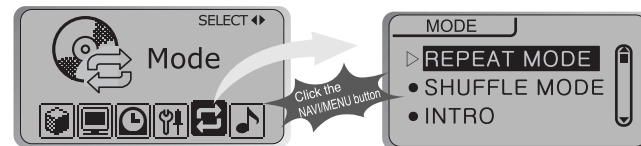

### Repeat Mode/ Shuffle Mode

A number of Repeat and Shuffle modes are available. Select the one you want by pressing MODE button (Multi selecting available) (refer to page 5-3, 5-4)

▼ How to select

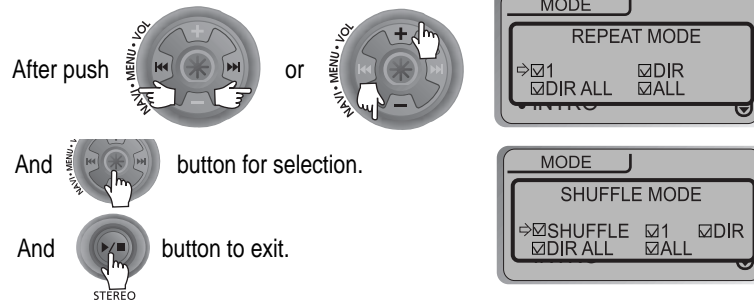

- ▶ Only the selected PLAYBACK MODE will be available when you press the MODE/REC button (For details, please refer to page 5-3, 5-4)



## MENU-Mode

### Intro Mode

**Intro:** Plays the beginning 10 seconds of each track.

**Intro Highlight :** Plays 10 seconds from 1 minute into each track in sequential order.



### STUDY MODE

While playing, short slide of the **⏮**, **⏭** (or VOL +, VOL -) lever will skip the current track set time ahead.

**OFF :** Study Mode is disabled.

The range is 1~60 seconds.

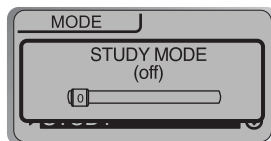

## MENU-Name

### Name

You can input your name or custom text. The saved text is displayed when playback stops.

#### ▼ Button Operation

Stopped playback ▶



Select the character by using **⏮** and **⏭** switch and press Navi/Menu button to input the character.



To move the cursor in the name window, use + and - on Volume switch.



MEMORY/EQ

To scroll between English and your preferred language, use MEMORY/EQ button.



MODE

To delete the character, press MODE button.



STEREO

Save and Exit

#### NOTE

Chinese and Chinese characters are not supported in the Name feature.

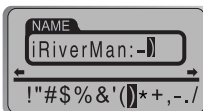
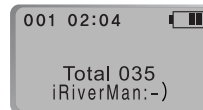

## Sound



## Xtreme EQ

You can adjust the sound to your preference. There are 5 band frequency steps, set from -15dB to +15dB by 3dB step.

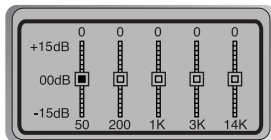

### • How to set Xtreme EQ

1. Select the Frequency step to set using the **◀◀**, **▶▶** switch.
2. Adjust the level using the VOL + or VOL - switch.
3. To exit Xtreme EQ setting

Select the Frequency

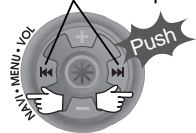

Adjust the level

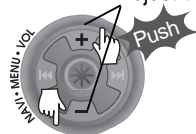

## Xtreme 3D

You can adjust the level of 3D sound (minimum, Natural, and Maximum). You can extend 3D sound by selecting Bass Boost or 3D EQ. You can also adjust the level of 3D sound with the **◀◀** or **▶▶** (or VOL +, VOL -) lever. Select DBE or 3D EQ with the Navi/Menu button.

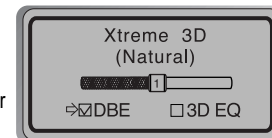

## DBE Setting

You can select the Bass Center Band level from Band 1 to 4. You can also set the Bass Boost gain from 0 dB to 15dB by 3dB step. DBE (Dynamic Bass Enhancement) enhances Low & Middle frequencies and only operates when using Xtreme 3D.

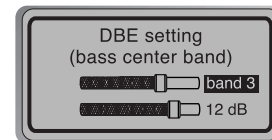

## 3D EQ Setting

Set EQ to User EQ to use 3D EQ. You can adjust the sound to your preference. There are 5 band frequency steps, set from -15dB to +15dB by 3dB step.

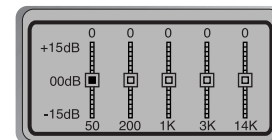

## MENU-Sound

### Sound Balance

Balance your sound to the right or left or keep it in the center according to your preference. When Sound Balance bar is moved to L (Left, 20), the sound outputs at the left earphone. When the lever is moved to R (Right, 20) the sound outputs at the right earphone. The default value is 0 and the sound outputs the same level at both earphones.

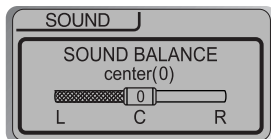

### EQ Limit

ON : Limit the control of equalizer frequency to prevent distortion of sound.  
OFF : You can enjoy the original sound though distortion of sound may occur.

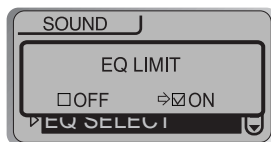

### EQ Select

You can select various EQ modes.  
Press NAVI/MENU button after selecting EQ by using **◀◀** or **▶▶** (or VOL +, VOL -) switch.

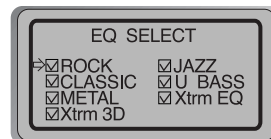

#### NOTE

You can not select NORMAL EQ.  
If you do not select Xtrm EQ or Xtrm 3D, Xtrm EQ or Xtrm 3D modes will not be available during playback.

## MENU-Sound

### Beep Volume

Set beep volume ON/OFF or level.  
Set to "0" for OFF.

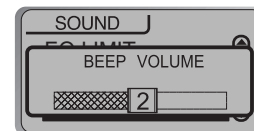

### Sound Fade in

When activated, volume increases gradually at playback mode to prevent sudden loudness.

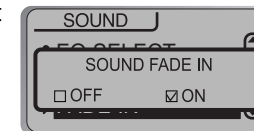

A large rectangular area with a rounded border and 15 horizontal lines, intended for taking notes or memos.

**Contents**

**TROUBLE SHOOTING** ..... **6-1**

**PRECAUTIONS** ..... **6-2**

**ACCESSORIES** ..... **6-3**

**SPECIFICATIONS** ..... **6-4**

## Trouble Shooting

Should any problem persist after you have checked these symptoms, consult your iRiver dealer or contact support at [www.iRiver.com](http://www.iRiver.com).

No Power	<ul style="list-style-type: none"><li>• Check whether the HOLD switch on the player is ON (Switch to OFF position)</li><li>• Check the condition of the battery. Insert a fresh battery.</li></ul>
No sound or distortion during playback.	<ul style="list-style-type: none"><li>• Check whether VOLUME is set to "0".</li><li>• Connect the earphones plug firmly.</li><li>• Check whether the plug is dirty. Clean the plug with a dry and soft cloth.</li><li>• Corrupted MP3 or WMA files may make a static noise and the sound may cut off. Listen to your files on the PC to see if they are corrupted.</li></ul>
Characters in LCD are corrupted.	<ul style="list-style-type: none"><li>• Check out Menu ▸ General ▸ Language and confirm whether the right language has been selected. (Refer to page 5-12)</li></ul>
Poor FM Reception.	<ul style="list-style-type: none"><li>• Adjust the position of the player and earphones. Turn off the power of other electric devices near the player.</li><li>• The Earphone cord functions as the antenna, they must be plugged in for best reception.</li></ul>
Failed download of MP3 file	<ul style="list-style-type: none"><li>• Check the condition of the battery.</li><li>• Check the connection between your computer and the player to ensure that the cable is secure.</li><li>• Check the Manager program to make sure it is operating.</li><li>• Check whether the player's memory is full.</li></ul>

## Precautions

### Safety

- **Avoid dropping or impacting the player.**  
The player is designed to operate while walking or running, but dropping or excessively impacting the player maybe cause damage.
- **Avoid contacting the player with water.**  
Damage to the internal parts of the player may occur if the player comes into contact with water. If your player gets wet, dry the outside with a soft cloth as soon as possible.
- **Do not leave the player in a location near heat sources, or in a place subject to direct sunlight, excessive dust or sand, moisture, rain, Mechanical shock, unlevelled surface, or in a car with its windows closed.**
- **Remove the battery if player is unused for long periods of time.**  
Battery left in the player for a long time can corrode and damage the device.
- **All data stored on this device may be erased by a excessive impact, a thunder or an electricity failure, etc. on the device.**  
The Manufacturer does not warrant and will not be held responsible in any way for damages or loss of data, including loss of data stored on this device, resulting from a excessive impact, a thunder or an electricity failure. You will be responsible for safe-guarding all data stored on this device.

### On Headphones and Earphones

- **Road Safety**  
Do not use headphones/earphones while driving, cycling, or operating any motorized vehicle. It may create a traffic hazard and is illegal in some areas. It can also be potentially dangerous to play your headsets at high volume while walking, especially at pedestrian crossings. You should exercise extreme caution or discontinue use in potentially hazardous situations.
- **Preventing hearing damage**  
Avoid using headphones/earphones at high volume. Hearing experts advise against continuously loud and extended play. If you experience a ringing in your ears, reduce volume or discontinue use.
- **Consideration for others**  
Keep the volume at a moderate level. This will allow you to hear outside sound and to be considerate of the people around you.

## Accessories

### 1 Earphone/ Earphone cover



### 2 USB cable



### 3 Installation CD



### 4 User Manual/Warranty card Quick Start Guide



### 5 Battery(AA type 1EA)

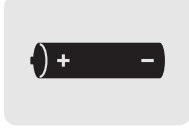

### 6 Neck strap for carrying



### 7 Carrying Case



### 8 Arm Band



### 9 Audio Cable (Line-In)

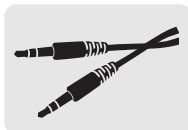

※ Accessories subject to change without notice and may vary from image shown.

## Specifications

Memory	128MB	256MB	512MB	1GB
Model No	iFP-880	iFP-890	iFP-895	iFP-899
USB version	1.1 (Full speed)	2.0 (High speed)	2.0 (High speed)	2.0 (High speed)

※ Memory is not expandable.

Category	ITEM	Specifications			
Audio	Frequency range	20 Hz ~ 20 KHz			
	Headphone Output	(L)18 mW + (R)18 mW (16 Ohm) max. Volume (L)12 mW + (R)12 mW (32 Ohm) max. Volume			
	S/N ratio	90 dB(MP3)			
FM TUNER	FM Frequency range	87.5 MHz ~ 108 MHz			
	S/N ratio	60 dB			
	Antenna	Headphone/Earphone-Cord Antenna			
FILE SUPPORT	File Type	MPEG 1/2/2.5 Layer 3, WMA, OGG, ASF			
	Bit Rate	8 Kbps ~ 320 Kbps (OGG : 44.1 KHz, 96Kbps~225Kbps)			
	Tag Info	ID3 V1, ID3 V2 2.0, ID3 V2 3.0, ID 3 V2 4.0			
Encoding	11.025KHz ~ 44.1KHz, 8Kbps ~ 320Kbps				
LCD	Full Graphic 4 Line with Backlight				
Language	40 Languages				
Voice Recording	Approx. 36:00 hrs (8kbps, 128 MB)	Approx. 72:00 hrs (8kbps, 256 MB)	Approx. 144:00 hrs (8kbps, 512 MB)	Approx. 288:00 hrs (8kbps, 1 GB)	
Max. Playtime	Approx. 40 hours (128 kbps, MP3, Volume : 20, EQ Normal, LCD: OFF, Alkaline "AA" 2400mAh)				
Dimension	88.5(W) x 36.2(D) x 27.3(H) mm				
Weight	40 g (w/o Battery)/ 65 g (Battery included)				
Battery	1 AA Type Alkaline battery				
Operational Temperature	-5 ℃ ~ 40 ℃				

---



---



## Free Manuals Download Website

<http://myh66.com>

<http://usermanuals.us>

<http://www.somanuals.com>

<http://www.4manuals.cc>

<http://www.manual-lib.com>

<http://www.404manual.com>

<http://www.luxmanual.com>

<http://aubethermostatmanual.com>

Golf course search by state

<http://golfingnear.com>

Email search by domain

<http://emailbydomain.com>

Auto manuals search

<http://auto.somanuals.com>

TV manuals search

<http://tv.somanuals.com>