

iriver T30

<http://www.iriver.com>

Instruction Manual T30

Thank you for your purchase.
Please read this manual carefully
before using your new player.

iriver www.iriver.com



• Some features might not be available in every region.

Before using the product

Welcome	03
Homepage	03
Copyrights/Certification/Trademarks/Limited Liability	04
Safety Instructions	05

Chapter 1 | Getting started

Components	09
Location of Controls	10
Connection/Installation	12

Chapter 2 | Quick start

Basic Usage	17
-------------------	----

Chapter 3 | Basic operation

MUSIC	21
BROWSER	31
*FM RADIO	32
RECORDING	37

* Only for models including FM Radio function

Chapter 4 | Useful features

Menu Configuration	43
Menu Operation	44
Customizing the function settings	46

Chapter 5 | Customer Support

Firmware Upgrade	65
Troubleshooting	66
Specification	67
Safety Information	68
FCC Certification	69



Welcome

Thank you for your iriver purchase

Thank you for your iriver purchase.

The T30 comes complete with a long list of advanced features. It is important that you read the manual to ensure that you get the most out of your new player.

<http://www.iriver.com>



Obtain information about your player, look for updates, and find answers to questions at our web site.

- iriver website address is www.iriver.com.
- The site provides product information and customer support.
- Use the firmware (system software) upgrade function of our products from the site to continuously improve the product performance.



Copyrights/Certification/Trademarks/Limited Liability

Copyrights

- iriver Limited has all the rights of the patent, trademark, literary property and intellectual property related to this manual. You may not reproduce any part of this manual unless authorized by iriver Limited. You can be punished by using any part of this manual illegally.
- The software, audio and video which have an intellectual property are protected by copyright and international laws. It is user's responsibilities when he/she reproduce or distribute the contents created by this product.
- The companies, institutions, products, people and events used in examples are not real data. We don't have any intension to be related with any companies, institutions, products, people and events through this manual and should not draw inferences. User's are responsible for observing the copyrights and intellectual properties.

©1999~2005 iriver Limited, All rights reserved

Certification

CE, FCC, MIC

Trademarks

- Windows 2000, Windows XP and Windows Media Player are the registered trademarks of Microsoft Corp.
- is a trademark of SRS Labs, Inc. WOW technology is incorporated under license from SRS Labs, Inc.

Limited Liability

- Neither the Manufacturer, importers nor dealers is responsible for any accidental damage including bodily injury or any damage resulting from misuse or unsuitable operation by you.
- The information on this manual is prepared with the current player specifications. The manufacturer, iriver Limited, is adding new features to the product and may persistently apply new technologies hereafter. All standards may be changed at any time without notice.



Safety Instructions

For your safety, please read before use.

Product

Keep away from harsh environments including humid, dusty, and smoky areas.

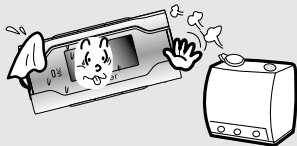

Do not drop or subject the device to impact.

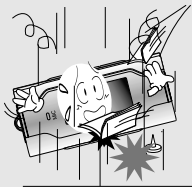

Do not disassemble or modify.



Keep out of direct sunlight and extreme heat and cold.

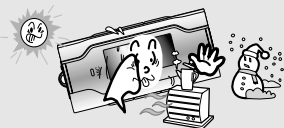

Do not use excessive force on the buttons or attempt to disassemble the device.



Do not clean using chemicals or detergents. Doing so may damage the surface or paint.



Safety Instructions

For your safety, please read before use.

Product

Keep the player away from strong magnets.

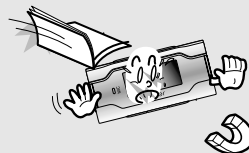

Avoid contact with water and other liquids and dry immediately with a soft cloth should contact occur.



Do not use headphone / earphones at high volume. Hearing experts advise against listening to continuous, loud and extended play.



Do not use headphones/earphones while cycling, driving, or operating any motorized vehicle. It is dangerous and is illegal in some areas.



Avoid impacting the player against other objects when it is in your pocket or backpack.



External impact, lightning, power shorts or other events may damage the data stored in the product. The user is solely responsible for data backup and the company will not be liable for loss of stored data under any circumstances.





Chapter

1

Components	09
Locating the controls	10
Product	10
LCD Screen display	11
Connection/Installation	12
Connecting to the PC	12
Connecting the earphones	13
Replacing the battery	13
WMP 10 installation	14



Components

- Accessories subject to change without notice and may vary from image shown.

Earphone



USB cable



Installation CD



User Manual/ Warranty card/Quick Start Guide



Battery(AAA Type, 1EA)



Neck strap for carrying



Locating the controls

- Your player may differ slightly from that shown in the illustrations.

Product

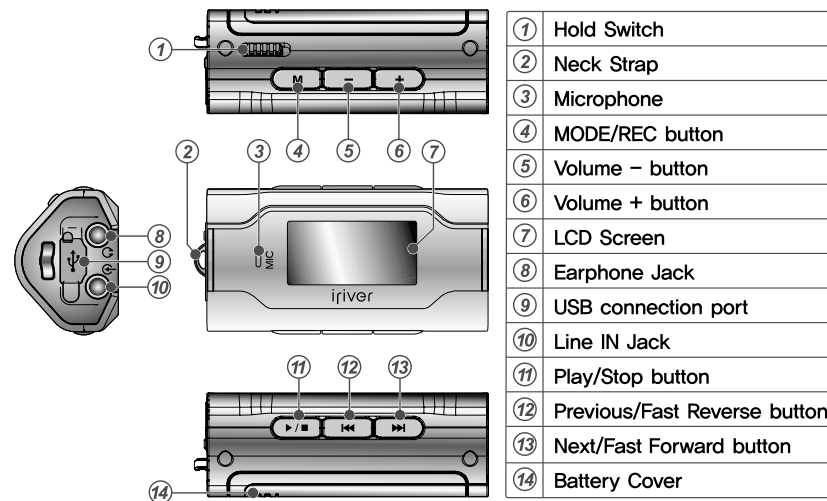



Locating the controls

LCD Screen display

1. MUSIC Mode

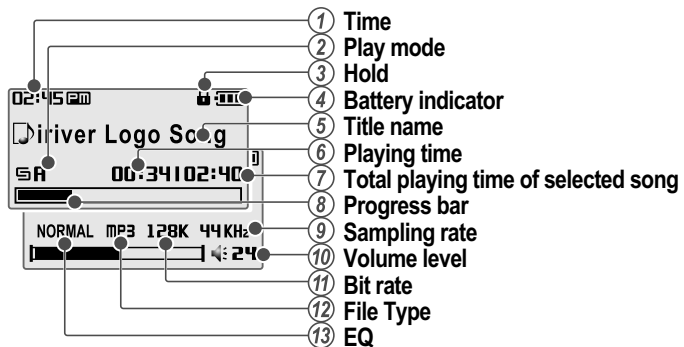

2. * FM RADIO Mode * Only for models including FM Radio function

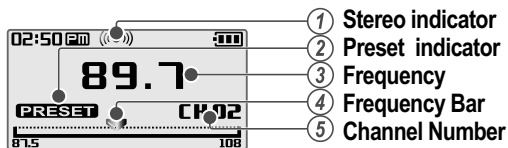

Connection/Installation

Connecting to the PC

1. Connect the USB cable (provided) to the USB port on the player and to your PC.

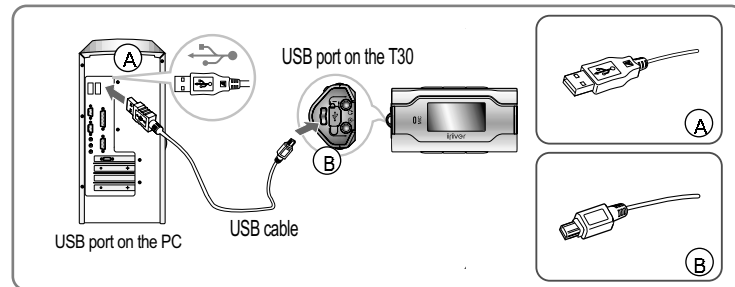

2. Turn on the player, "USB Connect" icon will appear on the LCD screen of the player.



3. Once installed, open Windows Explorer and an additional device should be listed called "iriver T30".



Connecting the earphones

1. Connect the earphones jack to the earphone socket on the player.

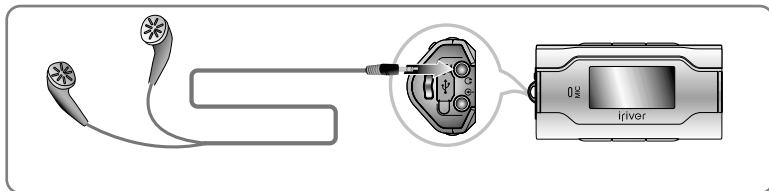

Replacing the battery

1. Open the battery cover.
2. Insert the battery. (AAA 1.5V type x 1ea)
Be sure to match the + and - ends of the battery with the diagram inside the battery compartment.
3. Close the battery cover.

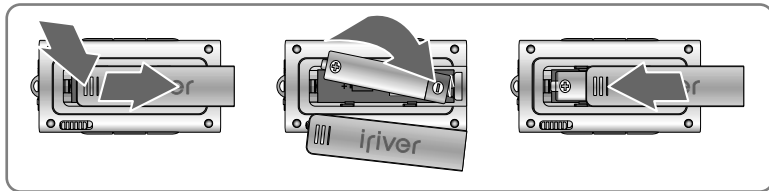

Note

- To avoid corrosion, remove the battery if the player is not to be used for a long time.
- When corrosion occurs, wipe the battery compartment immediately with a dry cloth and insert a new battery.

WMP 10 installation

1. The program installation process will start automatically after inserting the Installation CD to the PC's CD-ROM drive.
Click the [OK] button and follow the on screen instructions which appear as each window.





Chapter

2

Basic Usage	17
Turning on/off the player	17
Playing a music file	17
Selecting a music file	18
Adjusting the volume	18
Selecting the function mode	19



Basic Usage

Turning on/off the player



1 Turning on the player

Press the ►/■ button to turn on the player.

Previous function mode will be displayed.



Note

- If the player does not power ON, please replace your battery.



2 Turning off the player

Press and hold the ►/■ button.

Turns off the player.



Playing a music file



1 When powered on, press and hold M button to display the function mode screen.



2 Press ◀◀, ▶▶ button to choose the [MUSIC] mode then press ►/■ button.

Previous music file will resume playback.



Basic Usage

Selecting a music file



1 During the music file playback, press ◀◀, ▶▶ button to choose the desired music file.

◀◀ : to select previous music file

▶▶ : to select next music file



1 Adjusting the volume

During the music file playback, press -, + button to adjust volume level.

- : Decrease volume level.

+ : Increase volume level.





Basic Usage

Selecting the function mode

1 When powered on, press and hold **M** button to display the function mode screen.

Press **◀◀**, **▶▶** button to choose the desired function mode.



Note

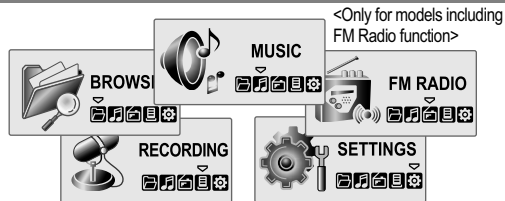

2 Press **▶/■** button to enter.

Press **M** button to cancel.



Basic operation

Chapter

3

MUSIC	21
Playing a music file	21
Selecting a music file	23
Changing playback mode	24
A-B Repeat	25
Changing the sound EQ	26
Download Music & Playlists	27
Deleting a file on the player	29
BROWSER	31
BROWSER	31
*FM RADIO	32
Listening to FM radio	32
Searching for a frequency - Manual Scan	33
Searching for a frequency - Auto Scan	33
Saving for a frequency - Manually	34
Saving for a frequency - Automatically	35
Selecting preset memory	35
Deleting a channel	36
RECORDING	37
To record *FM station	37
Recording voice	38
Recording from line-in	39
Note for recording	40
To play a recorded file	40





* Only for models including FM Radio function





Playing a music file

- 



1 Release HOLD switch, then press **▶/■** button to turn on the player.
Previous function mode will be displayed.

- 

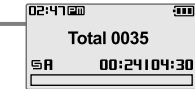

2 Press and hold **M** button to display the function mode screen.
Press **◀◀**, **▶▶** button to select [MUSIC] mode, then press **▶/■** button to enter.
Previous music file will resume playback.

- 



3 Stop music playback
Press **▶/■** button to stop music playback.
Press **▶/■** button again to continue playing.

- 



4 Adjusting the volume
During the music file playback, press **-**, **+** button to adjust volume level.
- : Decrease volume level.
+ : Increase volume level.





- 

5 Skipping to previous/next file
During the music file playback, press **◀◀**, **▶▶** button to skip to the previous/next file
◀◀ : previous file **▶▶** : next file

- 

6 Fast searching
Press and hold the **◀◀**, **▶▶** button for fast-forward or fast-reverse playback.
◀◀ : fast-rewind **▶▶** : fast-forward
Release the button for normal playback.





MUSIC

Selecting a music file

1 Press and hold **M** button to display the function mode screen.
Press **◀◀**, **▶▶** button to select **[BROWSER]** mode, then press **▶/■** button to enter.
The music file list screen will be displayed.

2 Use the **◀◀**, **▶▶**, **▶/■**, **M** buttons to, select a music file.
◀◀ : to move up ▶▶ : to move down
▶/■ : to enter the folder M : to exit the folder
To exit file list screen, press **M** button.

3 Press **▶/■** button to start playback.



MUSIC

Changing playback mode

Playback Mode can be changed in the [SETTINGS - Sound - Play Mode Select]. (Refer to page 47)

1 Press and hold **M** button to display the function mode screen.
Press **◀◀**, **▶▶** button to select **[SETTINGS]** mode, then press **▶/■** button to enter.
The **[SETTINGS]** screen will be displayed.

2 Press **◀◀**, **▶▶** button to choose the **[SOUND]**, then press **▶/■** button.
The **[SOUND]** sub-menu screen will be displayed.

3 Press **◀◀**, **▶▶** button to choose the **[Play Mode Select]**, then press **▶/■** button.
The **[Play Mode Select]** screen will be displayed.

4 Press **◀◀**, **▶▶** button to select desired playback mode, then press **▶/■** button.
The playback mode is changed to the selected mode.



Note

- The following icons are displayed to indicate playback mode.

Normal playback		Play all files in the player, then stop.
		Play all files in the current folder, then stop.
Repeat playback		Play a single file repeatedly.
		Play all files in the player repeatedly.
		Play all files in the current folder repeatedly.
Shuffle playback		Randomly play all files in the player, then stop.
		Randomly play all files in the current folder, then stop.
Shuffle playback repeatedly.		Randomly play all files in the player repeatedly.
		Randomly play all files in the current folder repeatedly.

A-B Repeat



- Press **M** button while playing to select the beginning (A) point.



- Press **M** button again to select the end (B) point.
Play a selected interval repeatedly.

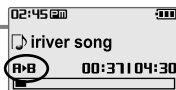

To cancel interval repeat, press the **M** button.



Changing the sound EQ

The sound EQ can be changed in the [SETTINGS - Sound - EQ select]. (Refer to page 47)



- Press and hold **M** button to display the function mode screen.



- Press **◀▶** button to select [SETTINGS] mode, then press **▶/■** button to enter.

The [SETTINGS] screen will be displayed.



- Press **◀▶** button to choose the [Sound], then press **▶/■** button.

The [SOUND] sub-menu screen will be displayed.

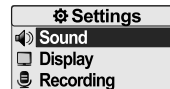

- Press **◀▶** button to choose the [EQ Select], then press **▶/■** button.

The [EQ Select] screen will be displayed.

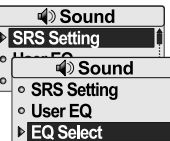

- Press **◀▶** button to select desired sound EQ, then press **▶/■** button.

The sound is changed to the selected EQ setting.

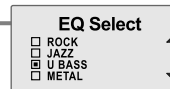
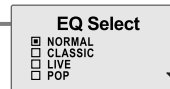

Note

- You can select one of the following EQ types:

NORMAL, CLASSIC, LIVE, POP, ROCK, JAZZ, U BASS, METAL, DANCE, PARTY, SRS, USER EQ



Download Music & Playlists

Get the latest version of Windows Media Player

In order to copy music & playlists to your player, you must use Windows Media Player 10.

The installation CD-ROM should include the proper version of Windows Media Player.

Windows Media Player 10 can also be found online at : www.microsoft.com/windowsmedia/download/

Please note, purchased music can only be copied to this player using Windows XP and the latest version of Windows Media Player.

1. Connect the USB cable to the USB port on the player and to your PC.

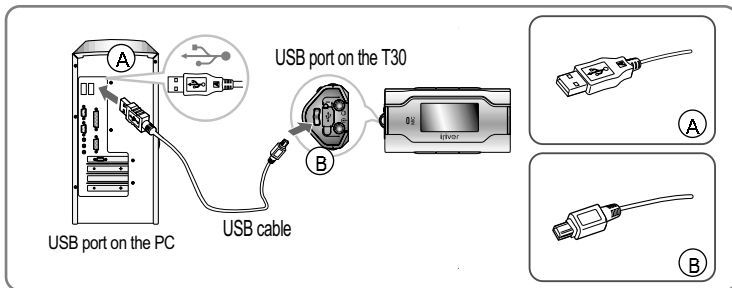

2. Open Windows Media Player.

- Click Start -All Programs -Accessories -Entertainment -Windows Media Player.
- Click "Library" from the menu button near the top of the screen..

Most of your music should be listed in this library. If not, check Windows Media Player help for more information about the library.



- Locate a Song or Playlist in the Library and Right-Click on it. Select "Add to -Sync List". A "Sync list" will appear on the right side of windows Media Player listing all the Songs & Playlists to be added to your player.



Repeat for all the songs or playlists you would like to add to your player.

- Click the "Sync" menu button. On the right side the Sync screen choose the T30 from the dropdown list.



- Click Start Sync to transfer the songs or playlists on to the T30 player. When complete, copied songs will appear in the "Synchronized to Device" list on the left side of Windows Media Player and in the specified folder on the right side of the screen.



Disconnect the player from your computer and enjoy your music!

If you prefer to Auto Sync, please select "Auto Sync" in the menu of Set Up Sync. You can Auto Sync music and playlists.



Deleting a file on the player

Th File can be deleted in the [SETTINGS - Advanced - Delete File].
(Refer to page 61)

- Press and hold **M** button to display the function mode screen.

Press **◀◀**, **▶▶** button to select [SETTINGS] mode, then press **▶/■** button to enter.

The [SETTINGS] screen will be displayed.

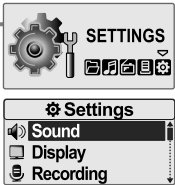
- Press **◀◀**, **▶▶** button to choose the [Advanced], then press **▶/■** button.

The [Advanced] sub-menu screen will be displayed.

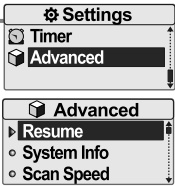
- Press **◀◀**, **▶▶** button to choose the [Delete File], then press **▶/■** button.

The [DELETE file] list screen will be displayed.



Note

■ While in a music file playback, delete functions are not available.



- Select a file to delete by using the **◀◀**, **▶▶**, **▶/■** button, then press **▶/■** button.

◀◀ : to move up **▶▶** : to move down
▶/■ : to enter the folder **M** : to exit the folder

- Press **◀◀**, **▶▶** button to choose the [Yes], then press **▶/■** button.

File is deleted on the player.



Note

■ You can not delete a folder at all.





BROWSER

BROWSER

1 Press and hold **M** button to display the function mode Screen.
Press **◀◀**, **▶▶** button to select [BROWSER] mode, then press **▶/■** button to enter.

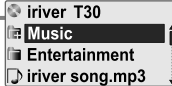
2 File list screen is displayed on the LCD screen.







* FM RADIO * Only for models including FM Radio function

Listening to FM radio

1 Press and hold **M** button to display the function mode Screen.
Press the **◀◀**, **▶▶** button to select [FM RADIO], then press the **▶/■** button to confirm.
The previous station is displayed.

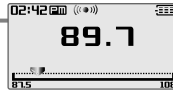
2 Press the **◀◀**, **▶▶** button to select your desired station.

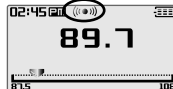
3 To change STEREO/MONO
Press the **M** button to display FM Radio function Selection screen.
Press the **◀◀**, **▶▶** button to select [STEREO ON or STEREO OFF], then press the **▶/■** button to confirm.
The station is changed to stereo or mono.

Note

- In areas where the signal is weak, some channels may be unavailable, or reception may be poor.



* **FM RADIO** * Only for models including FM Radio function

Searching for a FM radio frequency - Manual Scan



- 1 If PRESET is displayed, first press the **▶/■** button to exit PRESET mode.
Press the **◀◀, ▶▶** button to select your desired station.

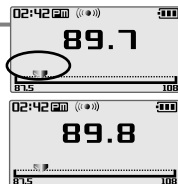

Searching for a FM radio frequency - Auto Scan



- 1 If PRESET is displayed, first press the **▶/■** button to exit PRESET mode.
To automatically locate a station press and hold the **◀◀, ▶▶** button.
The player will quickly scan through each frequency and stop at the next station that can be tuned in.



Note

■ While in Preset mode, auto scan functions are not available.



* **FM RADIO** * Only for models including FM Radio function

Saving an FM Radio frequency - Manually



- 1 If PRESET is displayed, first press the **▶/■** button to exit PRESET mode.
Press the **◀◀, ▶▶** button to select your desired station.

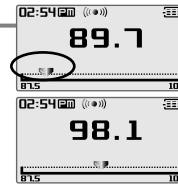

- 2 Press the **M** button to display FM Radio function Selection screen.



Press the **◀◀, ▶▶** button to select [SAVE CHANNEL], then press the **▶/■** button.
The Save Channel screen is displayed.



- 3 Select channel number by using the **◀◀, ▶▶** button, then press **▶/■** button to save.

■ : Saved □ : not used



To exit the Save Channel screen, press the **M** button.

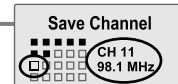
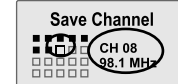

Note

■ Up to 20 stations can be saved.



* **FM RADIO** * Only for models including FM Radio function

Saving an FM Radio frequency - Automatically



1 Press the **M** button to display FM Radio function Selection screen.

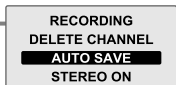

Press the **◀◀**, **▶▶** button to select [AUTO SAVE].

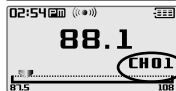

Press the **▶/■** button to to automatically select stations and save them in sequential order.



Selecting preset memory



1 If PRESET is not displayed, first press the **▶/■** button to enter PRESET mode.

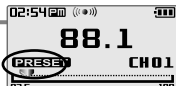

Press the **◀◀**, **▶▶** button to select your desired channel.

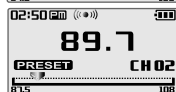

Note

- When the player does not have any preset stations, EMPTY will be displayed at Preset mode, then fade out.



* **FM RADIO** * Only for models including FM Radio function

Deleting a channel



1 If PRESET is not displayed, first press the **▶/■** button to enter PRESET mode.



Press the **M** button to display FM Radio function Selection screen.

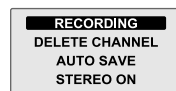

2 Press the **◀◀**, **▶▶** button to select [DELETE CHANNEL], then press the **▶/■** button.



The Delete Channel screen is displayed.

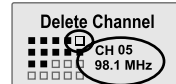

3 Select channel number by using the **◀◀**, **▶▶** button, then press **▶/■** button to delete.

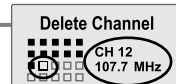

■ : Saved □ : not used



To exit the Delete Channel screen, press the **M** button.

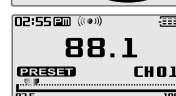







RECORDING

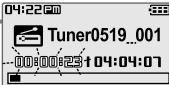
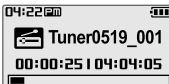

To record *FM station

* Only for models including FM Radio function

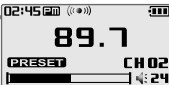
  	<p>1 Press the M button to display FM Radio function Slection screen. Press the ◀▶ button to select [RECORDING], then press the ▶/■ button. The station will be recorded.</p>	
	<p>2 Pausing station recording</p> <p>Press ▶/■ button to pause the recording process. Press ▶/■ button again to restart recording.</p>	 
	<p>3 Press the M button again to stop recording. The recorded file is saved.</p>	











Note

- The recorded file is saved as TUNERMDD_XXX.MP3 in the RECORD folder.
(MM : Month, DD : day, XXX : sequential number)
- Volume can not be controlled while recording.
- You can adjust recording quality at the SETTINGS-RECORDING-FM SETTING. (Refer to page 53)

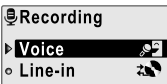
RECORDING

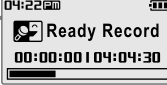

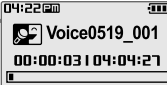
Recording voice

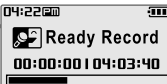
  	<p>1 Press and hold the M button to display function mode screen. Select the [RECORDING] by using the ◀▶ button, then press ▶/■ button. The recording select screen is displayed.</p>	 
 	<p>2 Select the [VOICE] by using the ◀▶ button, then press ▶/■ button. The recording standby screen is displayed.</p>	
 	<p>3 Press the M button to begin recording. Press ▶/■ button to pause the recording process. Press ▶/■ button again to restart recording.</p>	
	<p>3 Press the M button to stop recording. The recorded file is saved and then the recording standby screen is displayed.</p>	

Note

- The recorded file is saved as VOICEMDD_XXX.MP3 in the VOICE folder.
(MM : Month, DD : day, XXX : sequential number)
- Volume can not be controlled while recording.
- You can adjust recording quality at the SETTINGS-RECORDING-VOICE SETTING. (Refer to page 53)

RECORDING



Recording from Line-In

1 Press and hold the **M** button to display function mode screen. Select the [RECORDING] by using the **◀◀**, **▶▶** button, then press **▶/■** button. The recording select screen is displayed.

2 Select the [Line-In] by using the **◀◀**, **▶▶** button, then press **▶/■** button. The recording standby screen is displayed.

3 Press the **M** button to begin recording. Press **▶/■** button to pause the recording process. Press **▶/■** button again to restart recording.

3 Press the **M** button to stop recording. The recorded file is saved and then the recording standby screen is displayed.

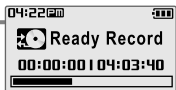
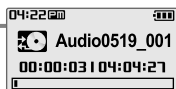
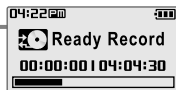
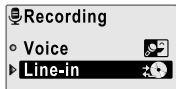

Note

- The recorded file is saved as AUDIOMMDD_XXX.MP3 in the RECORD folder. (MM : Month, DD : day, XXX : sequential number)
- Volume can not be controlled while recording.
- You can adjust recording quality at the SETTINGS-RECORDING-LINE-IN SETTING. (Refer to page 54)

Listening to music



Note for recording

The recording will be stop if

- the amount of recorded data exceeds the memory capacity of the player.
- the battery is low.

To play a recorded file

While Recording standby mode, press **▶/■** button to play recorded file. Previous recorded file will begin playing back.

1 Press and hold the **M** button to display function mode screen. Select the [BROWSER] by using the **◀◀**, **▶▶** button, then press **▶/■** button.

2 Select a recorded file in the [RECORD] or [VOICE] folder by using the **◀◀**, **▶▶**, **M**, **▶/■** button, then press **▶/■** button. The selected file will begin playing back.

▶◀◀ : to move up **▶▶▶** : to move down
▶/■ : to enter the folder **M** : to exit the folder

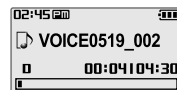
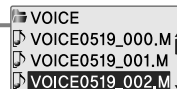



Chapter

4

Menu configuration	43
Menu operation	44
Enter Settings Menu	44
Enter Sub Menu	44
Set the menu functions	45
Exit sub menu	45
Customizing the function settings	46
Sound	46
Display	49
Recording	53
Timer	56
Advanced	59



Menu configuration

- Functions are subject to change with different firmware versions.
- Users can configure their own settings.

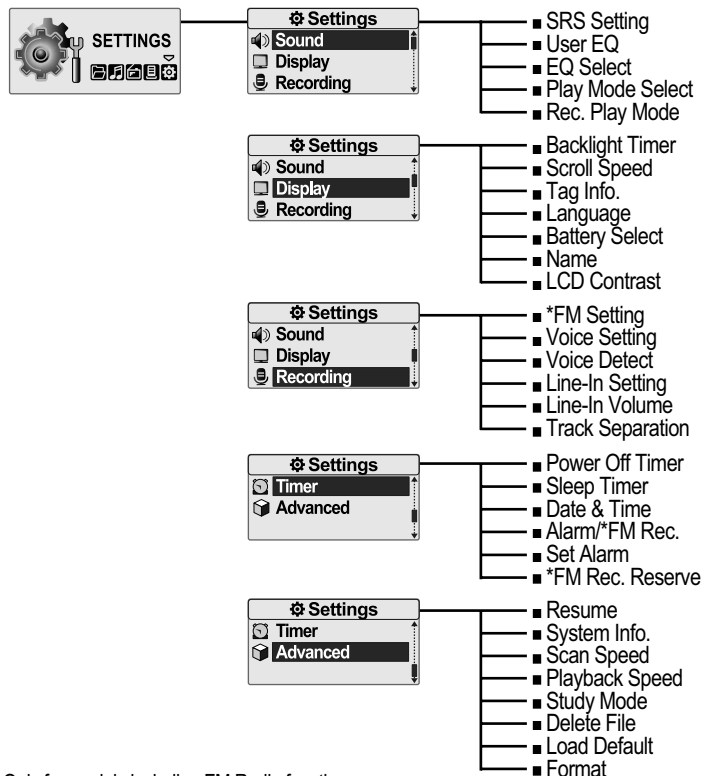

* Only for models including FM Radio function



Menu operation

Enter Settings Menu



1 Press and hold the **M** button to display the Mode screen.



Press the **◀◀**, **▶▶** button to select [SETTINGS] mode.

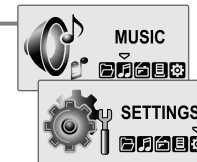

2 Press the **▶/■** button to display the Settings screen.



Press the **◀◀**, **▶▶** button to move the Settings menu.

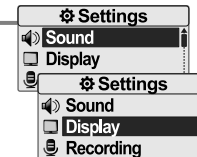

Enter Sub Menu



1 Press the **M** button to enter the sub menu screen.

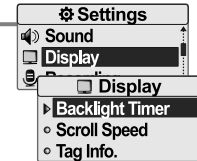



Menu operation

Set the menu functions



1 Select sub-menu using by -, + button, then press the ▶/■ button to enter sub-menu setting screen.

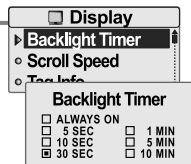

3 You can set, cancel or change sub menu setting by pressing the ◀◀, ▶▶, ▶/■ button.



Exit sub menu



1 Press the M button to exit sub menu.

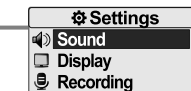

Customizing the function settings (Menu)

Sound

1. SRS Setting

Sets the 3D sound effect. SRS, FOCUS, TruBass, and Boost are available.

SRS : Adjust the SRS value.

FOCUS : Adjust the sound resolution value.

TRUBASS : Adjust the TruBass value.

BOOST : Adjust the sound boost value.

Use proper boost value depends on the earphones or headphone characteristics.

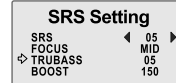
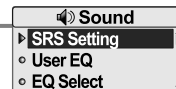

2. User EQ

You can adjust the sound to your preference.

There are 5 band frequency steps, set from <-15dB> ~ <+15dB> by 1dB increments.

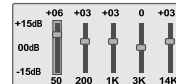
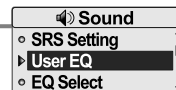



Listening to music

Sound

3. EQ Select

Select the EQ sound.

You can select one of the following EQ types:
NORMAL, CLASSIC, LIVE, POP, ROCK, JAZZ, U BASS,
METAL, DANCE, PARTY, SRS, USER EQ

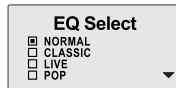
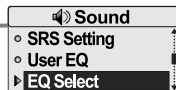

4. Play Mode Select

Select the play mode.

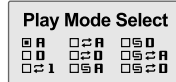

Listening to music

Sound

5. Rec. Play Mode

Select the play mode of recorded a file.



Customizing the function settings (Menu)



| Display

1. Backlight

You can adjust the time that the Backlight stays on.

The Backlight can be set to:

<ALWAYS ON>, <5 SEC>, <10 SEC>, <30 SEC>, <1 MIN>, <5 MIN> or <10 MIN>.

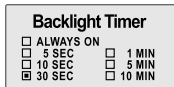

2. Scroll Speed

Select scroll type and speed of the current title playback information.

The scroll type can be set to:

<VERTICAL> or <HORIZONTAL>.

The scroll speed can be set to:

<SLOW>, <NORMAL> or <FAST>.

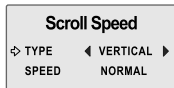

Customizing the function settings (Menu)



| Display

3. Tag Info.

While playing, you can display the information of music file by using ID3 Tag.

You can set <ON> or <OFF> .

Off : Display track with file name

- File name will be displayed by default for songs with no ID3 information

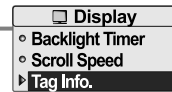

4. Language

Select the language to display the file name and ID3 tag information.

Support 40 languages.

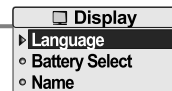



Customizing the function settings (Menu)

Display

5. Battery Select

Select the current battery.

You can set <RECHARGEABLE> or <ALKALINE>.

The player will manage the battery indicator icon to better match the usage level.

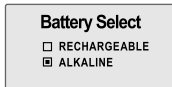
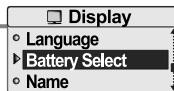

6. Name

You can input your name or custom text.



1 Select the character by using ◀◀, ▶▶ button and press ▶/■ button to input the character.

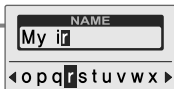

2 To move the cursor in the name window, use -, + button.

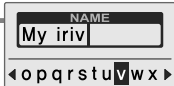

Customizing the function settings (Menu)

Display



3 To delete the character, press and hold - button.

To scroll between English and your preferred language, press and hold + button.

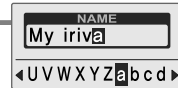

4 Press and hold M button to save and exit.

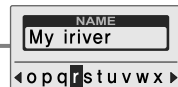

7. LCD Contrast

Adjust the LCD screen contrast.

The LCD contrast can be adjusted from <-5> to <+5>.

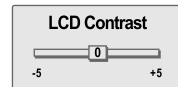



Customizing the function settings (Menu)

Recording

1. *FM Setting

You can set recording quality (<HIGH>, <MIDDLE> or <LOW>) when recording FM.

* Only for models including FM Radio function

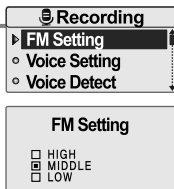

2. Voice Setting

You can set recording quality (<HIGH>, <MIDDLE> or <LOW>) when recording voice.

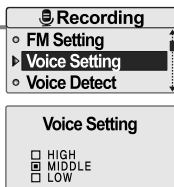

Customizing the function settings (Menu)

Recording

3. Voice Detect

The voice recording mode will automatically pause during silence. This is useful for recording over a long period of time to save memory.

LEVEL : Set the relative level of sound needed to activate the recorder. (<OFF>, <01>, <02>, <03>, <04> or <05>)

TIME(SEC) : Set the number of seconds of silence to record before pausing. (<OFF>, <01>, <02>, <03>, <05> or <10>)



4. Line-In Setting

You can set recording quality (<HIGH>, <MIDDLE> or <LOW>) when recording from external device.

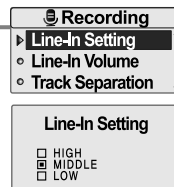

Customizing the function settings (Menu)



Recording

5. Line-In Volume

You can control volume for recording from voice.

<0> to <31> levels are available.

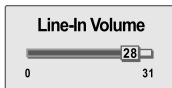

6. Track Separation

While recording from external device, you can adjust the track separation time to save each track as an individual file if there is no sound part between the tracks.

If you use the Track Separation function with connecting external devices such as CD or tape, each track will be save to an individual file.

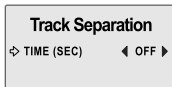

Listening to music



Timer

1. Power Off Timer

Automatically turns the power off at the stop mode.

Time range can be set from <1 MIN>, <2 MIN>, <3 MIN>, <5 MIN>, <10 MIN>, <20 MIN>, <30 MIN> or <60 MIN>.

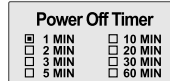

2. Sleep Timer

Automatically turns the power off after a fixed time.

Time range can be set from <OFF>, <5 MIN>, <10 MIN>, <20 MIN>, <30 MIN>, <60MIN>, <120 MIN> or <180 MIN>.
OFF : Sleep timer function does not activate.

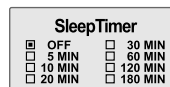
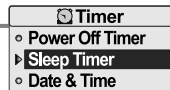



Customizing the function settings (Menu)

Timer

3. Date & Time

Set the current date and time.

Press the ◀◀, ▶▶ button to adjust the date/time.
Press the ▶/■ button to accept the changes.

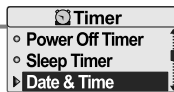

4. Alarm/*FM Rec.

OFF : The Alarm and FM Record functions are disabled and the player will not power on at either indicated time.

ALARM : At the time indicated in the "Set Alarm" setting the player will power on and begin music playback.

***FM RECORDING** : At the time indicated in the "FM Rec. Reserve" setting the player will power on and begin recording from the selected radio station.

* Only for models including FM Radio function

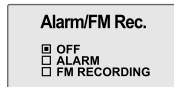
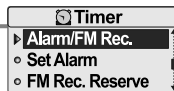

Customizing the function settings (Menu)

Timer

5. Set Alarm

Set the alarm time.

Press the ◀◀, ▶▶ button to adjust the alarm settings.
Press the ▶/■ button to accept the changes.

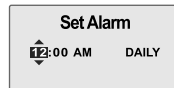
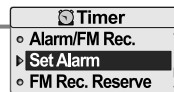

6. *FM Rec. Reserve

Set the time and station to be recorded.

* Only for models including FM Radio function

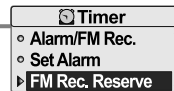

Customizing the function settings (Menu)



Advanced

1. Resume

ON : Playback will resume from the previous location in a song when the player is stopped or powered off.
OFF : Playback begins from the first track after the player is stopped or powered off.

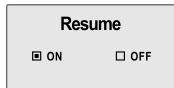
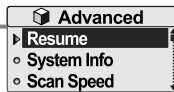

2. System Info.

You can check the firmware version information, free space memory and total number of tracks.

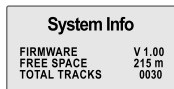
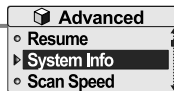

Customizing the function settings (Menu)



Advanced

3. Scan Speed

Adjust the speed of FF/RW(fast-forward/fast-rewind).

The Scan Speed can be set from <1X>, <2X>, <4X> or <6X>.

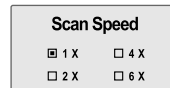
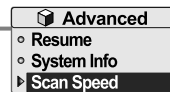

4. Playback Speed

Adjust the speed of playback.

The Playback Speed can be set from <-5> to <+5>.

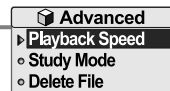

Customizing the function settings (Menu)



Advanced

5. Study Mode

While playing, press and hold ◀◀, ▶▶ button will skip the current track set time ahead.

Time range can be set from <OFF>, <3 SEC>, <10 SEC>, <20 SEC>, <30 SEC>, <60 SEC>, <120 SEC> or <180 SEC>.

OFF : Study Mode function does not activate.

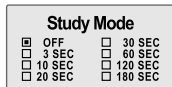
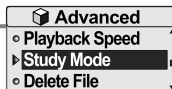

6. Delete File

While playback is stopped, you can delete a file on the player. (Refer to 29 page)

When in Delete file screen, press the ▶/■ button after selecting a file to delete it.

YES : Delete selected a file.

NO : Cancel the delete function.

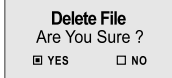
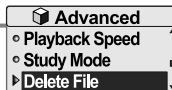

Customizing the function settings (Menu)



Advanced

7. Load Default

Reset menus to the original factory settings.

- When the Load Default is done, the player will be rebooted automatically.

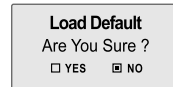
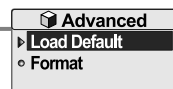

8. Format

Memory is formatted and all saved files are deleted.

Before formatting can begin, you must backup all data stored on the player.

Care must be taken as formatted files can not be recovered.

- When the Format is done, the player will be rebooted automatically.

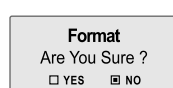
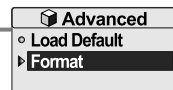



Chapter

5

Firmware Upgrade	65
Troubleshooting	66
Specification	67
Safety Information	68
FCC Certification	69



Firmware Upgrade

Firmware Upgrade

1 Download the latest firmware upgrade file from www.iriver.com/support.

2 Unzip the firmware file (T30_MTP.HEX) and copy the file to iriver T30:\ data folder on the player.

Disconnect the USB cable .

3 After the player is disconnected from the computer, firmware upgrade will automatically begin.

Note

- Before upgrading the firmware, check the condition of the battery. The firmware upgrade may fail due to battery power shortage.
- Do not turn the player off until the upgrade is completed.
- When the upgrade is completed, the firmware file(T30_MTP.HEX) will be deleted automatically.



Troubleshooting

Should any problem persist after you have checked these symptoms, consult your iriver dealer or contact support at www.iriver.com.

Trouble	Solution
No Power.	<ul style="list-style-type: none"> ■ Check whether the HOLD switch on the player is ON (Switch to OFF position) ■ Check the condition of the battery. Insert a fresh battery.
No sound or distortion during playback.	<ul style="list-style-type: none"> ■ Check whether VOLUME is set to "0". ■ Firmly connect the earphones. ■ Check whether the plug is dirty. Clean the plug with a dry and soft cloth. ■ Corrupted MP3 or WMA files may make a static noise and the sound may cut off. Listen to your files on the PC to see if they are corrupted.
Characters in LCD are corrupted.	<ul style="list-style-type: none"> ■ Check out SETTINGS →Display →Language and confirm whether the right language has been selected.(Refer to page 50)
Poor *FM Reception.	<ul style="list-style-type: none"> ■ Adjust the position of the player and earphones. ■ Turn off the power of other electric devices near the player. ■ The Earphone cord functions as the antenna, they must be plugged in for best reception.
Failed download of MP3 file	<ul style="list-style-type: none"> ■ Check the condition of the battery. ■ Check the connection between your computer and the player to ensure that the cable is secure. ■ Check whether the player's memory is full.
The title saved in T30 are not played.	<ul style="list-style-type: none"> ■ T30 supports up to 700 music files and 700 folders.



Specifications

Memory Capacity	256 MB*	512 MB*	1 GB*
Model No.	T30 256MB	T30 512MB	T30 1GB

Category	Item	Specifications		
Audio	Frequency range	20 Hz ~ 20 KHz		
	Headphone Output	(L)15 mW + (R)15 mW (16 Ohm) max. Volume		
	S/N ratio	90 dB(MP3)		
	Number of Channel	Stereo (Left/Right)		
FM Tuner**	FM Frequency range	87.5 MHz ~ 108 MHz		
	S/N ratio	60 dB		
	Antenna	Headphone/Earphone-Cord Antenna		
File Playback	File Type	MPEG 1/2/2.5 Layer 3, WMA, OGG, ASF		
	Bit Rate	MP3/WMA : 8Kbps~320Kbps, OGG : Q1~Q10		
	Tag Info	ID3 V1, ID3 V2.2.0, ID3 V2.3.0, ID 3 V2.4.0		
Recording	Max. Recording time (@32kbps)	256 MB	512 MB	1 GB
		Approx. 18 hours	Approx. 36 hours	Approx. 72 hours
General	Dimension	60 (W) x 30.4 (D) x 22.1 (H) mm		
	Weight	27 g (Battery excluded)		
	LCD	Full Graphic 4 Line with Backlight		
	Language	40 languages		
	Battery	AAA Type Alkaline battery 1EA		
	Operational Temperature	-5 °C ~ 40 °C		
	Max. Playtime	Approx. 20 hours (128 kbps, MP3, Vol 20, Backlight off, EQ Normal, Alkaline "AAA" 1000mAh)		

* 1 MB = 1,000,000 Bytes / 1 GB = 1,000 MB = 1,000,000,000 Bytes
Not all memory available for storage. Memory is not expandable.

** Only for models including FM Radio function



Safety Information

For Safety

- Avoid dropping or impacting the player.
The player is designed to operate while walking or running, but dropping or excessively impacting the player may be cause damage.
- Avoid contacting the player with water.
Damage to the internal parts of the player may occur if the player comes into contact with water. If your player gets wet, dry the outside with a soft cloth as soon as possible.
- Do not leave the player in a location near heat sources, or in a place subject to direct sunlight, excessive dust or sand, moisture, rain, mechanical shock, unlevelled surface, or in a car with its windows closed.
- Remove the battery if player is unused for long periods of time.
Battery left in the player for a long time can corrode and damage the device.
- All data stored on this device may be erased by a excessive impact, a thunder or an electricity failure, etc. on the device.
The manufacturer does not warrant and will not be held responsible in any way for damages or loss of data, including loss of data stored on this device, resulting from a excessive impact, a thunder or an electricity failure, You will be responsible for safe-guarding all data stored on this device.

On headphones and earphones

- Road Safety
Do not use headphones/earphones while driving, cycling, or operating any motorized vehicle. It may create a traffic hazard and is illegal in some areas. It can also be potentially dangerous to play your headset at high volume while walking, especially at pedestrian crossings. You should exercise extreme caution or discontinue use in potentially hazardous situations.
- Preventing hearing damage
Avoid using headphones/earphones at high volume. Hearing experts advise against continuously loud and extended play. If you experience a ringing in your ears, reduce volume or discontinue use.
- Consideration for others
Keep the volume at a moderate level. This will allow you to hear outside sound and to be considerate of the people around you.



FCC Certification

THIS DEVICE COMPLIES WITH PART 15 OF THE FCC RULES. OPERATION IS SUBJECT TO THE FOLLOWING TWO CONDITIONS:

- (1) THIS DEVICE MAY NOT CAUSE HARMFUL INTERFERENCE, AND**
- (2) THIS DEVICE MUST ACCEPT ANY INTERFERENCE, RECEIVED, INCLUDING INTERFERENCE THAT MAY CAUSE UNDESIRED OPERATION.**

Note : This equipment has been tested and found to comply with the limits for a Class B digital device, pursuant to part 15 of the FCC Rules. These limits are designed to provide reasonable protection against harmful interference in a residential installation.

This equipment generates, uses and can radiate radio frequency energy and, if not installed and used in accordance with the instructions, may cause harmful interference to radio communications. However, there is no guarantee that interference will not occur in a particular installation. If this equipment does cause harmful interference to radio or television reception, which can be determined by turning the equipment off and on, the user is encouraged to try to correct the interference by one or more of the following measures :

- Reorient or relocate the receiving antenna.
- Increase the separation between the equipment and receiver.
- Connect the equipment into an outlet on a circuit different from that to which the receiver is connected.
- Consult the dealer or an experienced radio/TV technician for help.

NOTE: THE MANUFACTURER IS NOT RESPONSIBLE FOR ANY RADIO OR TV INTERFERENCE CAUSED BY UNAUTHORIZED MODIFICATIONS TO THIS EQUIPMENT. SUCH MODIFICATIONS COULD VOID THE USER'S AUTHORITY TO OPERATE THE EQUIPMENT.

Memo



Memo



Memo



Free Manuals Download Website

<http://myh66.com>

<http://usermanuals.us>

<http://www.somanuals.com>

<http://www.4manuals.cc>

<http://www.manual-lib.com>

<http://www.404manual.com>

<http://www.luxmanual.com>

<http://aubethermostatmanual.com>

Golf course search by state

<http://golfingnear.com>

Email search by domain

<http://emailbydomain.com>

Auto manuals search

<http://auto.somanuals.com>

TV manuals search

<http://tv.somanuals.com>