

*iRIVER*

Model iFP-120/140/180T

***iRIVER* Limited**  
http://www.iRiver.com

<http://www.iRiver.com>

**Instruction Manual**

*iRIVER*

**MP3 PLAYER / FM TUNER**

Model iFP-120/140/180T

**MP3**  
DIGITAL AUDIO

Plays  
**Windows  
Media™**

**FM**  
TUNER



***Firmware Upgradable***

Thank you for purchasing our product.  
Please read this manual carefully before use.

*iRIVER*

## FCC Certification

THIS DEVICE COMPLIES WITH PART 15 OF THE FCC RULES. OPERATION IS SUBJECT TO THE FOLLOWING TWO CONDITIONS: (1) THIS DEVICES MAY NOT CAUSE HARMFUL INTERFERENCE, AND (2) THIS DEVICE MUST ACCEPT ANY INTERFERENCE, RECEIVED, INCLUDING INTERFERENCE THAT MAY CAUSE UNDESIRED OPERATION.

Note : This equipment has been tested and found to comply with the limits for a Class B digital device, pursuant to part 15 of the FCC Rules. These limits are designed to provide reasonable protection against harmful interference in a residential installation. This equipment generates, uses and can radiate radio frequency energy and, if not installed and used in accordance with the instructions, may cause harmful interference to radio communications. However, there is no guarantee that interference will not occur in a particular installation. If this equipment does cause harmful interference to radio or television reception, which can be determined by turning the equipment off and on, the user is encouraged to try to correct the interference by one or more of the following measures :

- Reorient or relocate the receiving antenna.
- Increase the separation between the equipment and receiver.
- Connect the equipment into an outlet on a circuit different from that to which the receiver is connected.
- Consult the dealer or an experienced radio/TV technician for help.

## Introducing the iRiver website

- URL : <http://www.iRiver.com>
- Provides information on our company, products, and email addresses for support.
- Unique feature of "Firmware (system software) Upgrade" is available for download on our site. The Firmware provides new features as well as enhancements to current features. New CODECS that will be introduced in the future will be supported via Firmware Upgrade.
- Provides FAQ as well as a User's Forum.
- Register your iRiver product online so that our Customer Service is able to provide support as efficiently as possible.

iRiver Limited does not assume any responsibility for errors or omissions in this document or make any commitment to update the information contained herein.

iRiver is a registered trademark of iRiver Limited in the Republic of Korea and /or other countries and is used under license. Microsoft Windows Media and the Windows Logo are trademarks or registered trademarks of Microsoft Corporation in the United States and /or other countries.

All other brand and product names are trademarks of their respective companies or organization. All other product names may be trademarks of the companies with which they are associated.

© 1999-2002 iRiver Limited. All right reserved.

## Unique Features of iFP-120/140/80T

- **Unique Design**
- **Multi-Codec Player**  
: Supports MP3, WMA, ASF formats.
- **Firmware Upgrade**  
Provides the latest updated features via free downloads from our website. New formats such as AAC, MP3Pro and Ogg Vorbis, (if supported by iRiver in the future) can be added to the player with a simple firmware upgrade.
- **Graphic LCD supporting Multiple Languages**  
: iFP-120/140/180T comes with graphic LCD which can support multiple languages, including: English, French, Spanish, German, Italian, other alphabet-oriented fonts, Korean and Japanese(Katakana, Hirakana, Kanji). Over 30 languages are supported.
- **FM Function**(Option : FM Tuner included only on model iFP-180T)  
You can easily listen to FM stations and set your favorite stations by using Auto Preset and Frequency Memory functions.
- **6 Equalizing Patterns** : Normal, Rock, Jazz, Classic, U Bass, User EQ
- **GUI (Graphic User Interface) Menu provides easy navigation.**
- **Supports up to 8 folder levels.**
- **Program your own playlist.**

## Contents

### 1. CONTROLS

Front View, Side View 1.....	5
Side View 2, Top/Bottom View.....	6
LCD Window.....	7

### 2. BASIC OPERATION

Basic Operation.....	8~10
Installing Software on the PC.....	11~15
Downloading from the PC.....	16~17
Uploading to the PC.....	18~19
Deleting Files/Folders on the player.....	20
Deleting files on the PC.....	21
Initializing/ Making new folders/Refresh.....	22
Listening to music.....	23~24
Operating the FM Tuner.....	25~28
Recording FM.....	29
Recording Voice.....	30~31

### 3. Useful Features

Navigation.....	32~33
Mode.....	33~34
Program Mode.....	35~37
EQ Mode.....	38
Menu Controls.....	39~48

### 4. Additional Information

Power Supply(Battery).....	49
Trouble Shooting.....	50
Precautions.....	51
Accessories.....	52
Specifications.....	53

4

## CONTROLS

### FRONT VIEW

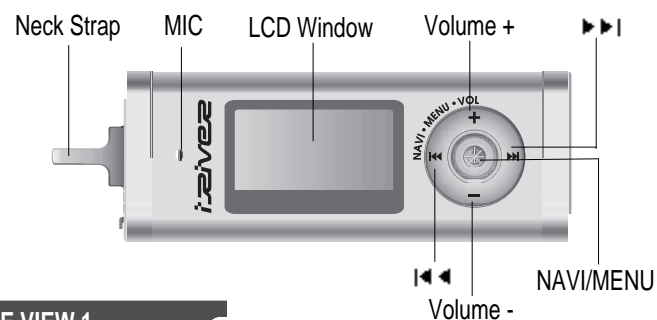

### SIDE VIEW 1

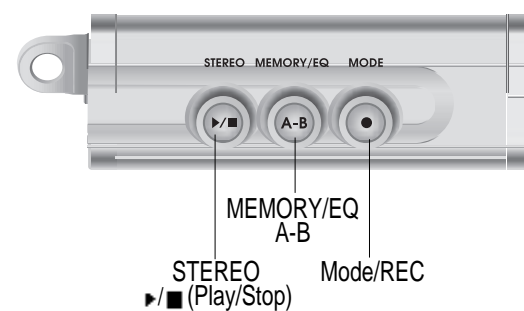

5

## CONTROLS

### SIDE VIEW 2

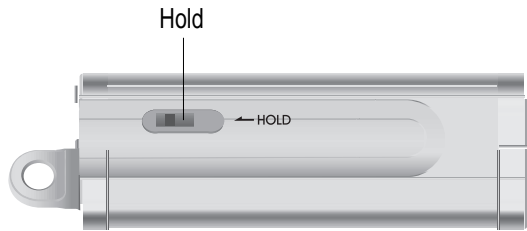

### TOP/BOTTOM VIEW

USB Connection Port  
Earphone

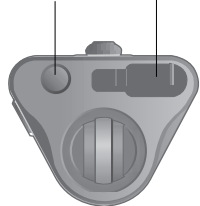

Battery Compartment

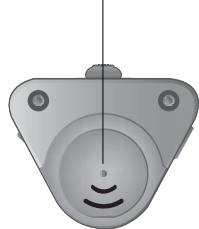

6

## CONTROLS

### LCD Window

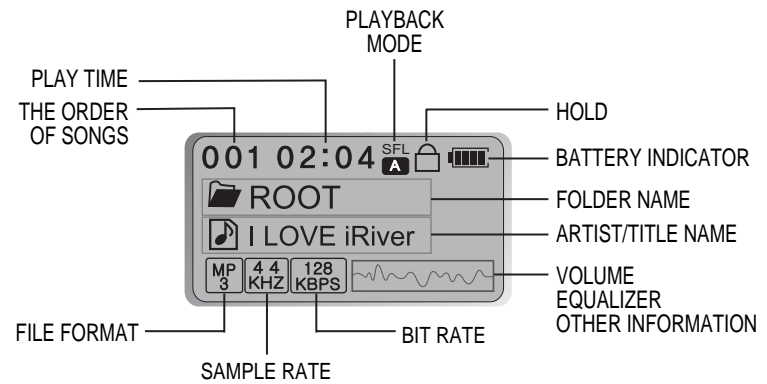

7

## BASIC OPERATION

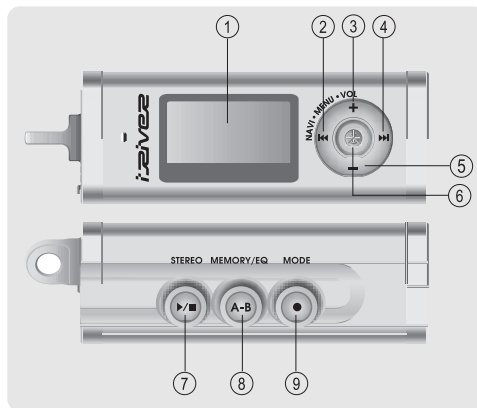

### When using Navigation



### When using Menu



1. LCD window.
2. To select the previous music for MP3 or station for FM.
3. To increase volume
4. To select the next music for MP3 or station for FM.
5. To decrease volume
6. To select NAVI/MENU function.
7. To start or stop playback for MP3, to select mode for FM or turn off
8. To select EQ mode, A-B repeat or memory stations for FM automatically.  
EQ : NORMAL → ROCK → JAZZ → CLASSIC → U BASS → USER EQ
9. To select function, playback mode, or record/stop recording.

8

## BASIC OPERATION

### BASIC OPERATION



Press + on volume button to increase volume and press – on button to decrease volume.



Selecting FM Mode :



(Refer to p. 25)

MP3 ↔ FM ↔ VOICE Changing :

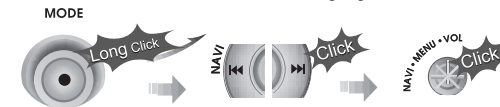

### NAVIGATION

Press NAVI/MENU button and find the desired track by pressing the VOL + or VOL – button. To select the track, press the NAVI/MENU button, ►| or the PLAY/STOP button.

To move to the upper folder, push the ◀◀ switch.  
If there is no upper folder, NAVIGATION stops.

9

## BASIC OPERATION

### MENU

A long press of the **NAVI/MENU** button will execute the menu function.

- ① Scrolling between menus : Press **◀◀** and **▶▶**
- ② Exit : Push the **VOL -** switch down or hold down the **NAVI/MENU** button.
- ③ Select Function: Press the **NAVI/MENU Button** to down.

### MODE

While an MP3 file is playing, press **MODE/REC** to activate selected modes, such as Repeat and Shuffle.

Press and hold the **MODE/REC** button:  
You can select MP3 or FM or voice recording functions (Play mode is automatically activated when MP3 is selected).

10

## INSTALLING SOFTWARE ON THE PC

- **Insert the Installation CD into the CD-ROM drive. The following screen appears after inserting the CD.**



- When installation is automatically not started, execute the setup.exe under the Root folder of the installation CD, and then the Manager program is automatically setup.
- The installation CD contains the following contents :
  - Device Driver
  - Manager Program
- You can save MP3 files or other types of files on the PC or the Player by using the Music Manager Program.
- You can update the features of the player by downloading from the internet. (Log on to [www.iriver.com](http://www.iriver.com))

### System Requirements

- Pentium 133MHz or faster
- USB port
- Window 98 SE / ME / 2000 / XP
- CD-ROM drive
- 10MB free hard disk space

11

## INSTALLING SOFTWARE ON THE PC

### Caution

Before connecting the USB cable to the player, stop playback.

### 1 To install "New hardware"

#### 1 Connect the USB cable(provided) to the USB port of your computer.

Type "A" : USB port on the panel of the PC      Type "B" : USB port of iFP-100  
Connect the USB cable to match the direction.

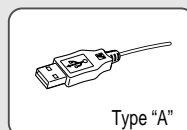
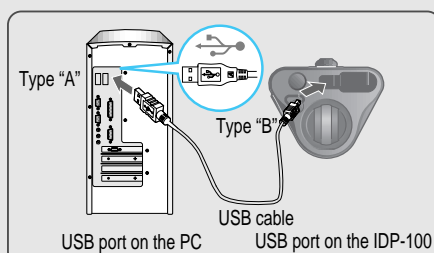

Type "A"

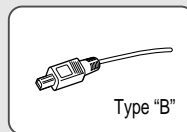

Type "B"

2 Turn on the player, remove the protective cover of USB port, and connect the USB cable.

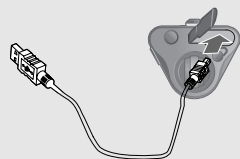

3 "USB CONNECTED" will appear on the LCD of the player.



12

## INSTALLING SOFTWARE ON THE PC

4 The following screen appears when connecting the USB cable. Select the folder to install. Click "NEXT".

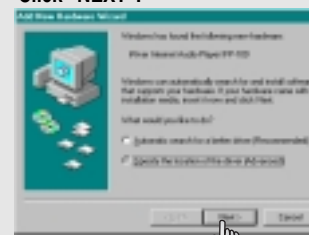

5 Select "iRiverDriver" folder to Install. Click "OK".

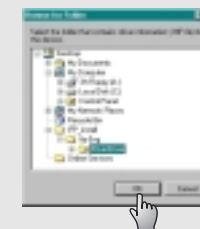

6 Click "NEXT".

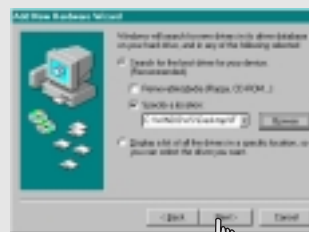

7 Click "NEXT".

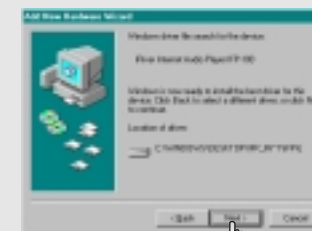

13



## INSTALLING SOFTWARE ON THE PC

- 8 Click "Finish"  
Complete the installation of "New hardware".

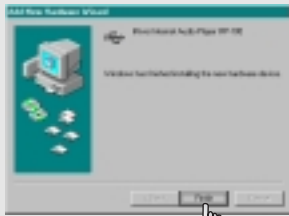

### 2 To install "Manager"

- 1 Click "SETUP.EXE" in the ROOT to start the installation. (When installation is automatically not started.)

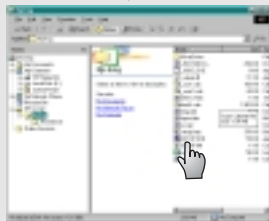

- 2 Click "NEXT".

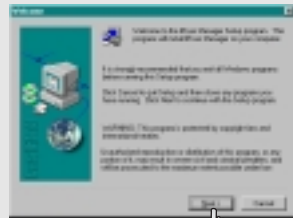

14

## INSTALLING SOFTWARE ON THE PC

- 3 Select the folder to install.  
Click "NEXT".  
Generally assigned as "C Driver → Program File → iRiver → iRiver-Manager"

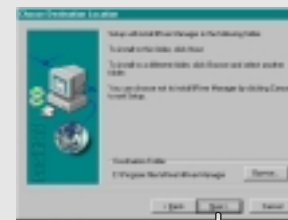

- 4 Click "NEXT".

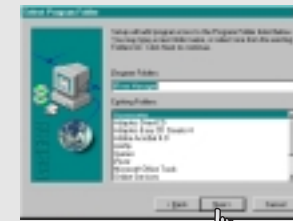

- 5 Click "Finish"  
Complete the installation of "Manager".

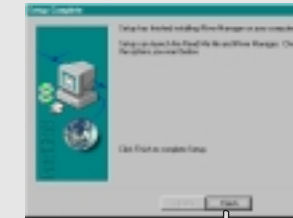

15

## DOWNLOADING FROM THE PC

Activate the Manager program after connecting the USB cable between the player and the PC.

- 1 Double click the Manager icon on the PC to open the Manager program.

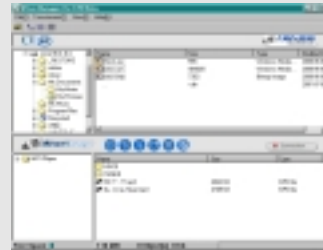

- 2 Select the folder on the PC to download to the player.

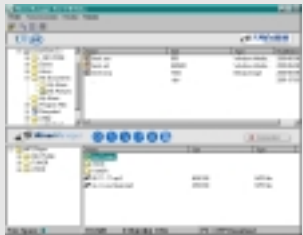

- 3 Select the folder to be saved in the player.

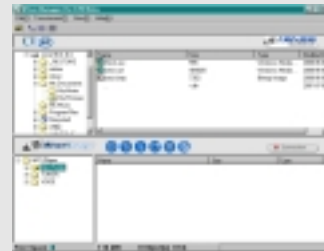

16

## DOWNLOADING FROM THE PC

- 4 Click the "Download" icon or select "Download" in the Transfer menu to download.

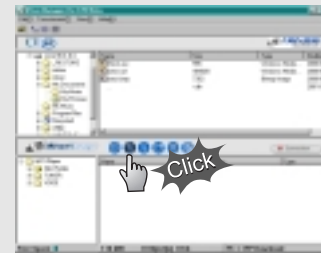

17

## UPLOADING TO THE PC

Activate the Manager program after connecting the USB cable between the player and the PC.

- 1 Double Click the Manager icon on the PC.

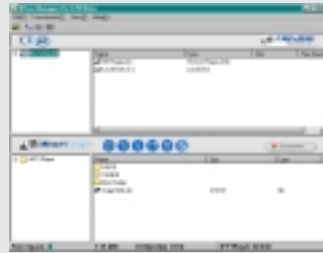

- 2 Select the folder to be saved on the PC.

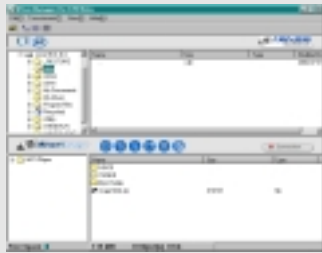

- 3 Select files in the player to save.

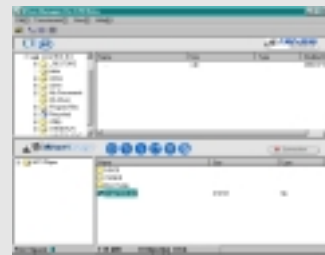

18

## UPLOADING TO THE PC

- 4 Click the "Upload" icon or select "Upload" in the Transfer menu to upload.



- You cannot upload general music files from the player to the PC according to copyright laws.  
You can upload files made by the player or general data files besides music files.

19

## DELETING FILES/FOLDERS ON THE PLAYER

### To delete files

- 1 Stop playback.
- 2 Click the "NAVI/MENU" button.
- 3 Select the files to delete by using VOL + or VOL -.

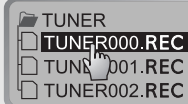

- 4 Click the "MODE" button. "File delete are you sure?" is displayed on the LCD. Select "yes" by using I◀◀ and ▶▶I to delete.

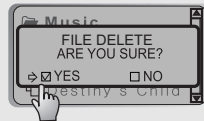

### To delete folders

- 1 Stop playback.
- 2 Click the "NAVI/MENU" button.
- 3 Select the folder to delete.



- 4 Click the "MODE" button. "Folder delete are you sure?" is displayed on the LCD. Click "yes" to delete.

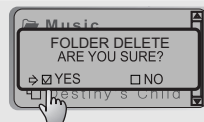

\* **Note** : You can only delete a blank folder. In order to delete a folder, you must first delete the files in the folder.

## DELETING FILES ON THE PC

Activate the Manager program after connecting the USB cable between the player and the PC.

- 1 After starting the "Manager" program, select the files to delete.



- 2 Click the "Delete" icon or select "Delete" in the File menu to delete.

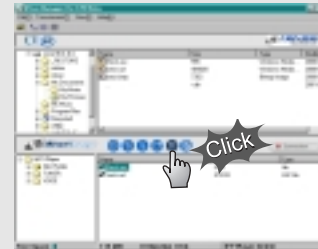

- 3 Click "yes".



## INITIALIZING/ MAKING NEW FOLDERS/REFRESH

### To open the Manager Program

Double click the Manager icon on the PC to open the Manager program.



### To initialize the player

Click the "format" icon or select "format" in the file menu to format.



### To make a new folder

Click the "New Folder" icon or select "New folder" in the file menu to make a new folder. (Refer to p. 20 to delete folders)



\* You can make up to 8 folder levels. The pathname, which includes the directory and file names, is limited to 512 characters.

### To refresh the contents of the player

Click the "Refresh" icon to display the contents of the player.



22

## LISTENING TO MUSIC

### 1 Connect the earphones as below.



### 2 Put the HOLD switch to "OFF".



### 3 Turn the player on by pressing the Play/Menu button.



### 4 To select music

◀◀ : To select previous music  
▶▶ : To select next music



### 5 To adjust the volume

+ : To increase volume  
- : To decrease volume



### Note

- By turning Hold ON, the buttons on the player will not function.
- In case of stop status of MP3 or standby status of Voice recording, the player automatically turns off according to the setting of "STOP POWER OFF" on the MENU.

23

## LISTENING TO MUSIC



- To turn on the player



- To Play



- To change the function (MP3 → FM → Voice recording)



- To stop



- To advance



- To reverse



- To play the next folder



- To play the previous folder



- To fast forward



- To fast reverse



- To turn off the player



24

## OPERATING THE FM TUNER

\* FM Tuner included only on model iFP-180T.

- While playing MP3, Press the MODE/REC button.



The function selection picture displays on the LCD.



- Push the <<< >>> button to select FM RADIO. Press the NAVI/MENU button to confirm.



- Press the PLAY/STOP button to select Stereo/Mono.



25

## OPERATING THE FM TUNER

\* FM Tuner included only on model iFP-180T.

### Memory Function (Save channels)

- 1 Select the channel by pushing the or switch to the left or the right.

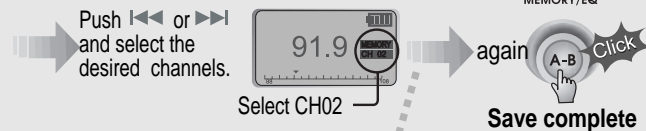
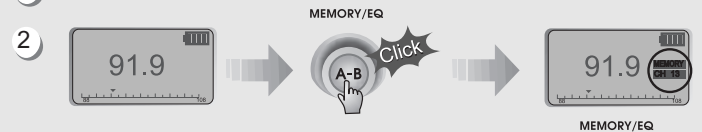

- 3 Up to 20 channels can be memorized.

- 4 Auto memory function :  
Automatically select channels  
and save them in sequential  
order. (It only activates while the player is not in PRESET mode)

► Note : Auto memory may not work within weak transmission areas.

26

## OPERATING THE FM TUNER

\* FM Tuner included only on model iFP-180T.

### Selecting Frequency(FM 87.5MHz ~ 108MHz)

- 1 To change frequency, push the or switch to the left or the right.

(ex : 87.5 — 87.6)

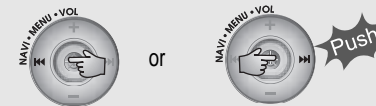

- 2 Auto Scan function: To select a memorized channel, press the Navi/Menu button and find the channel by pushing the or switch to the left or the right.



- 3 PRESET Mode : To select a channel saved in memory, press the Navi/Menu button and find the channel by pushing the or switch to the left or the right.

Example)

(ex : 89.1 — 91.9)

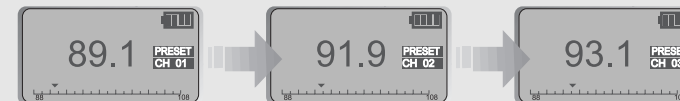

27

## OPERATING THE FM TUNER

### Memory delete function (Delete saved channels)

- 1 Select the channel to be deleted at preset mode.
- 2 Press and hold the memory button.



- The next channel will appear when channel delete is completed. Push the memory button if you want to delete the next channel also.
- ▶ FM Tuner reception may vary in different areas.
- ▶ While in Preset mode, auto scan and auto memory functions are not available.
- ▶ When the player does not have any preset channels, EMPTY will be displayed at preset mode then fade out.

### Press the PLAY/STOP button to turn the player off.



28

## RECORDING FM

### To record FM

Press  the MODE/REC button during FM play.



### To stop FM recording

Press  the MODE/REC button again to stop recording.

The recorded file is saved as TUNER000.REC. It is saved in the TUNER folder.



### To play a recorded file

After changing to MP3 mode, select a Tuner file in the TUNER folder, press the PLAY/STOP button.

### Note

Volume is not controlled during recording.

29



## RECORDING VOICE

1 Press and hold the MODE/REC button.



2 Press the <<< or >>> switch to select Voice mode.



3 Press the NAVI/MENU button(or PLAY/STOP) to go to Voice recording mode.



4 Press the MODE/REC button and voice recording starts.



30

## RECORDING VOICE

● To stop recording

Press the MODE/REC button.



● To play a recorded file

Press the PLAY/STOP button.



- The recorded file is saved as form of VOICE000.REC. It is saved in the VOICE folder under ROOT.
- If -00.00.00- is displayed on the LCD, the player's memory is full. To record, delete files and/or folders on the player in order to make some space available. (Refer to p. 20-21)

31

## NAVIGATION

- Navigation is the function used to search tracks.

You can select a song by pressing the NAVI/MENU button and using the VOL +, VOL - buttons.

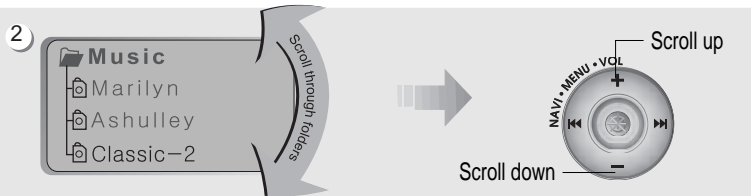
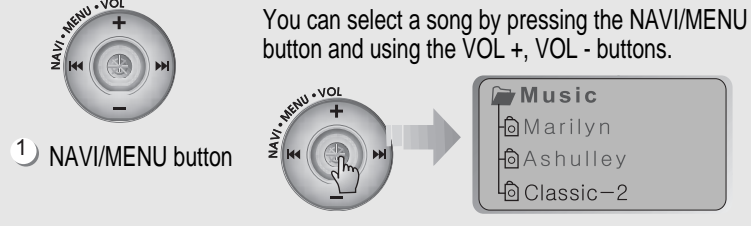

- 3 Select Folder or Scroll to Upper Folder

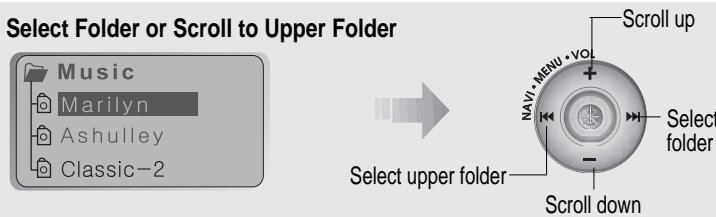

32

## NAVIGATION

- 4 Select the track



## MODE

You can set various Repeat and Shuffle options by choosing these selections under Mode.

Please refer to the function controls (page 47) for user-defined configuration.

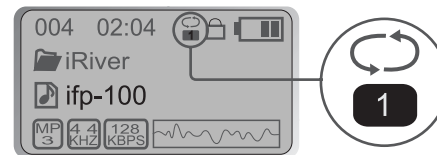

◀ When the MODE/REC button is pushed, the icon in the playback mode indicator is changed.

33

## MODE

### REPEAT

	Play a single track repeatedly.
	Play all tracks in the folder and stop.
	Play all tracks in the folder repeatedly.
	Play all tracks in the player repeatedly.

### SHUFFLE

SFL	Randomly play all tracks in the player repeatedly and stop.
SFL D	Randomly play all tracks in the folder repeatedly and stop.
SFL DA	Randomly play all tracks in the folder repeatedly.
SFL A	Randomly play all tracks in the player repeatedly.

### INTRO

	<b>INTRO:</b> Plays the beginning 10 seconds of each track in sequential order. <b>INTRO HIGHLIGHT:</b> Plays 10 seconds from 1 minute into each track in sequential order. For example, song A plays 10 seconds from 1 minute into the song, so the highlight ends at 1 minute 10 seconds. Then song B plays 10 seconds from 1 minute into the song, so the highlight ends at 1 minute 10 seconds, and so on with each track.
--	---

34

## PROGRAM MODE

MEMORY/EQ Program mode: Create your own playlists.

### Activating Program mode

**At stop mode**

Scroll to Program mode ▶

▶ Program mode is activated while in Stop Mode.  
▶ Repeat A-B is activated while in Play Mode.

**2** Push the VOL +, VOL - switch to select the number to be programmed.

Music name

35

## PROGRAM MODE

- 3 After pressing the NAVI/MENU button, select the music to program by using the VOL+, VOL - switch.

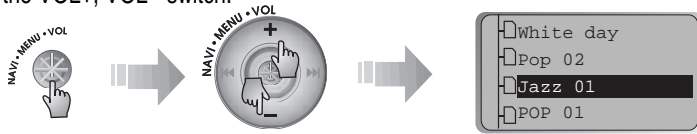

- ▶ Push the VOL + or VOL - switch to select a folder, then press the MEMORY/REC button to save all files in the folder.

- 4 Press the MEMORY/EQ button.

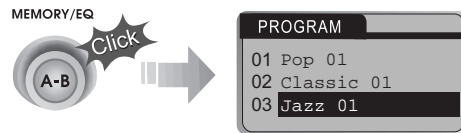

### To delete programmed files

Press the MODE/REC button after selecting the file to be deleted. Then the program list is automatically changed.

36

## PROGRAM MODE

### Program play

After programming, press  to play the tracks in sequential order.



### Cancel Program Mode

While in Stop Mode



### Interval Repeat

Play a selected interval repeatedly

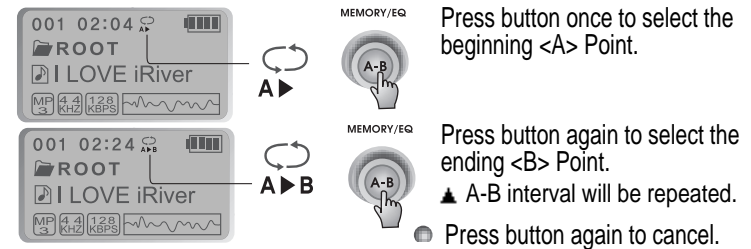

37

## EQ MODE

### EQ MODE

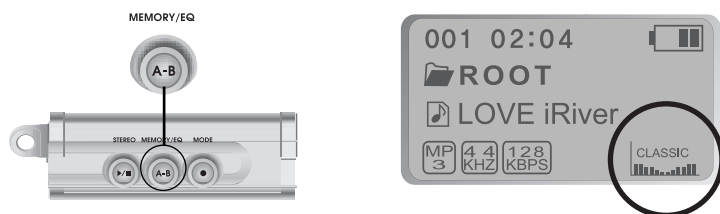

Press and hold the MEMORY/EQ button to display the current EQ.  
Every time you click this button, the EQ mode scrolls in sequential order.

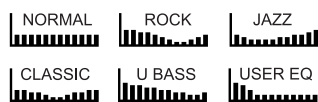

**Note:** Please refer to the Function Control (Page 48) for configuring User Defined EQ.

38

## MENU (FUNCTION CONTROLS)

Function Control is subject to change with different firmware versions. Users can configure their own settings.

### Configuration

#### GENERAL

- beep volume
- resume
- fade in
- language
- load default

#### DISPLAY

- back light
- lcd contrast
- visualization
- tag information
- time

#### TIMER

- sleep
- pwr off

#### CONTROL

- fast skip
- scan speed
- scroll speed
- sound balance
- AGC control

#### MODE

- repeat
- shuffle
- intro

#### User EQ

- bass boost
- treble boost

39

## MENU

### Menu Operation

- Press and hold the NAVI/MENU button to display the menus. It is composed of 6 main menus with sub-menus.

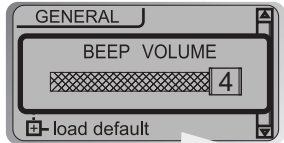

When you select a sub menu, you can set your preference to be displayed.

#### Shift between Menus

- Press the ◀◀ or ▶▶ button to move between main menu and sub menu.

#### From Main Menu to Sub Menu

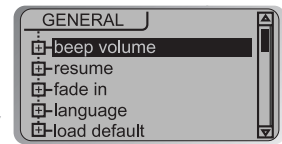
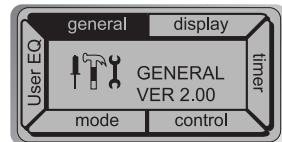
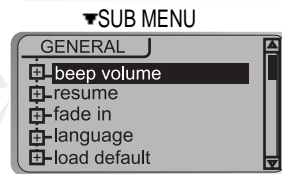
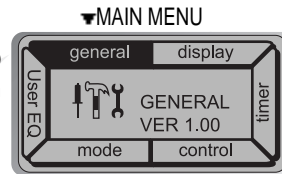
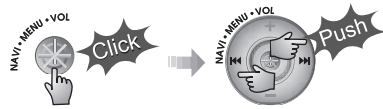

40

## MENU

### Enter Sub Menu

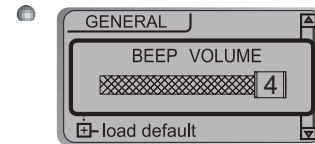

◀ Each control option is configured.



### Exit Sub Menu



### Exit Function Control mode



41

## MENU(GENERAL)

### GENERAL

#### BEEP VOL

: Configure beep sound with volume level.  
Set to "0" for OFF.

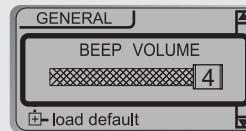

#### RESUME

: When activated, the player returns to the same settings after STOP or Power OFF.

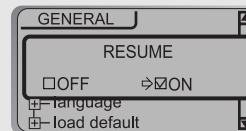

#### FADE IN

: When activated, volume increases gradually at playback mode to prevent sudden loudness.

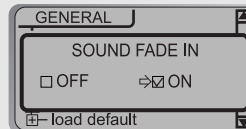

#### LANGUAGE(Supports 36 languages)

: When activated, displays proper fonts for File/ Folder names and ID3 tag information.

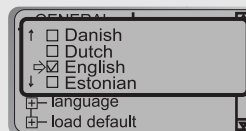

42

## MENU(General & Display)

#### LOAD DEFAULT VALUE

: Initialize to original factory setting.  
Button operation order is as below.  
▶|| (select default menu) → ◀◀◀ (select YES) → ▶|| (select YES : Initialization)

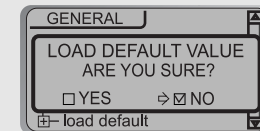

### Menu(Display)

#### BACK LIGHT

: You can adjust the time that the Backlight stays on from OFF to 30 seconds.

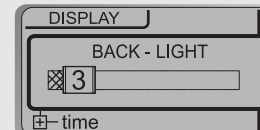

#### LCD CONTRAST

: Adjust LCD contrast.

Contrast can be adjusted by using the ◀◀ and ▶▶ buttons.

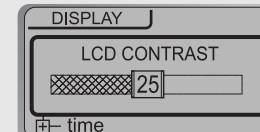

43

## MENU(DISPLAY)

### VISUALIZATION

: Can display the visualization of the audio signal in play mode, the elapsed time of a track, or the free space in memory.

WAVEFORM ▶ 

PROGRESSIVE ▶ 

FREE SPACE ▶ 



### TIME

Normal : display elapsed time.

Remain : display remaining time.

Note : If the track format is VBR, the time may not be accurate.

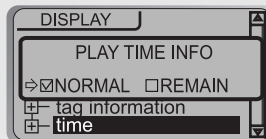

### TAG INFORMATION

On : Display track with ID3 tag information

Off : Display track with filename when you set the tag information off, the track is playing and the next track can be displayed with ID3 tag information.



44

## MENU(TIMER & CONTROL)

### TIMER(Set Auto Power Off)

#### SLEEP POWER OFF

: Automatically turns power off after a fixed time (Time range can be set from 0 to 99 minutes)

Use the ◀◀ or ▶▶ button to adjust time.

▶ When the power is off, the sleep power off setting goes back to Zero setting.

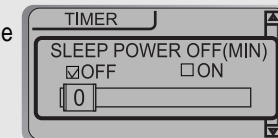

#### STOP POWER OFF

: Automatically turns power off at stop mode. (1 ~ 60 minutes)

Use the ◀◀ or ▶▶ button to adjust time.

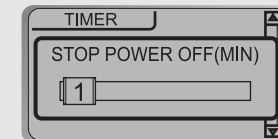

### CONTROL

#### FAST SKIP

OFF : Skip does not activate.

10 : Playback previous or next 10th track.

Directory : Skip to previous or next directory.



45



## MENU(CONTROL)

### SCAN SPEED

The fast scan speed can range from 1x/2x/4x/6x.

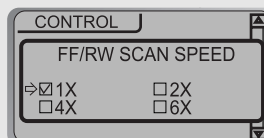

### SCROLL SPEED

Adjust scroll speed by 1x/2x/4x

Vertical : The scroll goes up and down

Horizontal : The scroll goes from the left to the right.

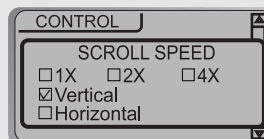

### SOUND BALANCE

Balance your sound to the right or left or keep it in the center according to your preference.

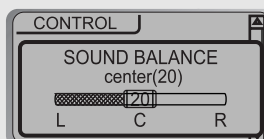

### AGC CONTROL

ON : When voice recording, the recording level is automatically controlled and then the sound from a long distance is normally recorded.

The recorded sound quality may be worse than that of OFF mode.

OFF: AGC Control not activated.



46

## MENU(PLAYBACK MODE)

### MODE

#### REPEAT MODE / SHUFFLE MODE (Page 33~34)

: A number of Repeat and Shuffle modes are available. Select the one you want by pressing Navi/Menu to enter the Mode menu.

▼ ex



Pushing button to enter

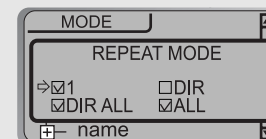

And button for selection.



And button to exit.

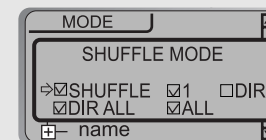

▶ Only the selected play mode will be applied when you press the MODE/REC button (For details, please refer p. 33~34)

#### INTRO MODE

**Intro**: Plays the beginning 10 seconds of each track.

**Intro Highlight**: Plays 10 seconds from 1 minute into each track in sequential order. For example, song A plays 10 seconds from 1 minute into the song, so the highlight ends at 1 minute 10 seconds.



47

## MENU(USER EQ)

### Menu (User EQ)

#### BASS BOOST

: The Bass Boost switch is from 0 to 24dB.  
24dB is the maximum bass boost.

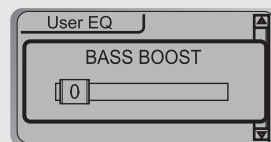

#### TREBLE BOOST

: The Treble boost level is from 0 to 6dB.  
6dB is the maximum treble boost.

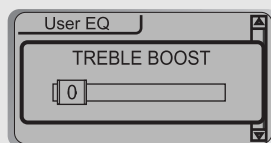

48

## POWER SUPPLY(BATTERY)

### Inserting a battery

#### 1 Open the battery cover.

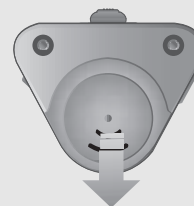

#### 3 Close the battery cover.

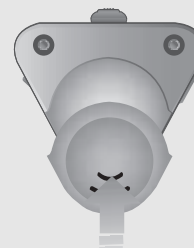

#### 2 Insert the battery.

Be sure to match the + and - ends of the battery with the diagram inside the battery compartment.

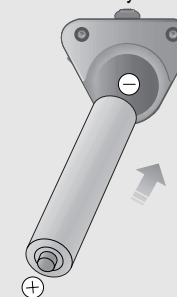

#### Note

- To avoid corrosion, remove the batteries if the player is not to be used for a long time.
- Remove dead batteries immediately to avoid damage from corrosion.
- When corrosion occurs, wipe the battery compartment immediately with a dry cloth and insert a new battery.

49

## TROUBLE SHOOTING

Should any problem persist after you have checked these symptoms, consult your iRiver dealer or contact support at [iRiver.com](http://iRiver.com).

<b>No Power</b>	<ul style="list-style-type: none"> <li>■ Check whether the batteries have been inserted in properly.</li> <li>■ Check whether the HOLD switch on the player is ON (Switch to OFF position)</li> </ul>
<b>No sound from earphones.</b>	<ul style="list-style-type: none"> <li>■ Check whether VOLUME is set to "0". Connect the earphones/remote plug firmly.</li> <li>■ Check whether plug is dirty. Clean the plug with a dry and soft cloth.</li> <li>■ Corrupted MP3 or WMA files may make a static noise and the sound may cut off. Check your files on the PC to see if they are corrupted.</li> </ul>
<b>Characters in LCD are corrupted.</b>	<ul style="list-style-type: none"> <li>■ Check out Menu ▶ Display ▶ Language and confirm whether the right language has been selected.</li> </ul>
<b>Poor FM Reception.</b>	<ul style="list-style-type: none"> <li>■ Adjust the position of the player and earphones.</li> <li>■ Turn off the power of other electric devices nearby the player.</li> <li>■ Earphones function as the antenna.</li> </ul>
<b>Failed download of MP3 file</b>	<ul style="list-style-type: none"> <li>■ Check the condition of the battery.</li> <li>■ Check the connection between your computer and the player to ensure that the cable is secure.</li> <li>■ Check the Manager program to make sure it is operating.</li> <li>■ Check whether the player's memory is full.</li> </ul>

50

## PRECAUTIONS

### Safety

- Vibration experienced during walking or exercising will not affect the player. However, dropping the player or dropping a heavy object on the player may result in damage or sound distortion.
- Avoid spilling any liquid onto or into the player.
- Do not leave the player in a location near heat sources or in a place subject to direct sunlight, excessive dust or sand, moisture, rain, mechanical shock, or an unlevelled surface or in a car with the windows closed during excessive heat.

### On Headphones and Earphones

#### ● Road Safety

Do not use headphones/earphones while driving, cycling, or operating any motorized vehicle. It may create a traffic hazard and is illegal in some areas. It can also be potentially dangerous to play your headsets at high volume while walking, especially at pedestrian crossings. You should exercise extreme caution or discontinue use in potentially hazardous situations.

#### ● Preventing hearing damage

Avoid using headphones/earphones at high volume. Hearing experts advise against continuously loud and extended play. If you experience a ringing in your ears, reduce volume or discontinue use.

#### ● Consideration for others

Keep the volume at a moderate level. This will allow you to hear outside sound and to be considerate of the people around you.

51

## ACCESSORIES

### 1) Earphone/Earphone sponge

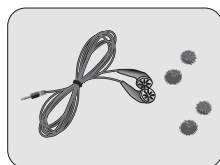

### 2) USB cable

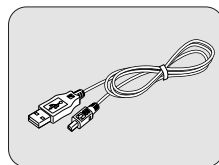

### 3) Installation CD

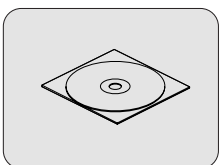

### 4) User Manual/Warranty card



### 5) Battery(AA type 1EA)

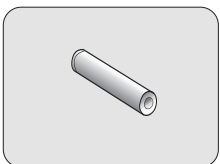

### 6) Neck strap for carrying

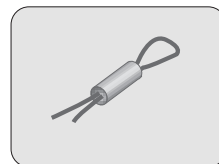

※ Accessories subject to change without notice and may vary from image shown.

52

## SPECIFICATIONS

☞ Distributing copies of MP3 tracks without permission is a violation of international copyright laws.

	iFP-120	iFP-140	iFP-180T
<b>Memory</b>	32 MB	64 MB	128 MB
<b>Color</b>	White Pearl	Bright Silver	Gun Metal
<b>FM Tuner</b>	X	X	O

Category	ITEM	Specifications
<b>FM TUNER</b>	FM Frequency range	87.5 MHz ~ 108 MHz
	Headphone Output	(L)10 mW + (R)10 mW (16 Ohm) max. Volume
	S/N ratio	50 dB
	Antenna	Headphone/Earphone-Cord Antenna
<b>Dimension</b>		31 x 28.5 x 82 mm(95mm : With Ring for Necklace)
<b>Weight</b>		32 g(iFP-180T) / 29 g(iFP-120/140) (without Battery) 52 g(iFP-180T) / 49 g(iFP-120/140) (with Battery)
<b>Battery</b>		1 AA size Alkaline battery
<b>Audio</b>	Frequency range	20 Hz ~ 20 KHz
	Headphone Output	(L)10 mW + (R)10 mW (16 Ohm) max. Volume
	S/N ratio	90 dB(MP3)
<b>FILE SUPPORT</b>	File Type	MPEG 1/2/2.5 Layer 3, WMA, ASF
	Bit Rate	8 Kbps ~ 320 Kbps
	Tag Info	ID3 V1, ID3 V2 2.0, ID3 V2 3.0, ID 3 V2 4.0
<b>LCD</b>		Full Graphic 4 Line with Backlight
<b>Language</b>		36 Languages
<b>Voice Recording</b>		Approx. 2:15 hrs (32kbps, 32 MB)   Approx. 4:30 hrs (32kbps, 64 MB)   Approx. 9:00 hrs (32kbps, 128 MB)
<b>Max. Playtime</b>		Approx. 20 hours(128 kbps, MP3)
<b>USB</b>		USB 1.1
<b>Operational Temperature</b>		- 5 degrees ~ 40 degrees Celsius

53

## Free Manuals Download Website

<http://myh66.com>

<http://usermanuals.us>

<http://www.somanuals.com>

<http://www.4manuals.cc>

<http://www.manual-lib.com>

<http://www.404manual.com>

<http://www.luxmanual.com>

<http://aubethermostatmanual.com>

Golf course search by state

<http://golfingnear.com>

Email search by domain

<http://emailbydomain.com>

Auto manuals search

<http://auto.somanuals.com>

TV manuals search

<http://tv.somanuals.com>