

# Iqua miniUFO Bluetooth® Handsfree PHF-301

## User Guide



Communicate in style

Download from [Www.Somanuals.com](http://www.Somanuals.com). All Manuals Search And Download.

## Contents

About Bluetooth® Technology .....	2
General Information .....	3
Getting Started .....	6
Call functions .....	10
Advanced Call Functions .....	12
Product Specifications .....	14
Battery Information .....	15
Care and Maintenance .....	16
Correct disposal of this product .....	17
12 MONTH LIMITED WARRANTY .....	18

## About Bluetooth® Technology

Bluetooth is technology used for wireless communication between devices.

Bluetooth technology is based on a radio receiver and transmitter built into a tiny microchip, one of which is incorporated into this product and the other in a compatible mobile phone.

Bluetooth enables wireless connections between a device and a mobile phone within a radius of 10 meters of each other, without a physical cable or a line-of-sight connection.

Iqua miniUFO Bluetooth® Portable Handsfree can be used with any brand of Bluetooth mobile phones that supports Headset or Handsfree profiles. For the latest compatibility information, please visit [www.iqua.com](http://www.iqua.com).

The Bluetooth word mark and logos are owned by Bluetooth SIG, Inc. and any use of such marks by IQUA is licensed. Other trademarks and trade names belong to their respective owners.

## General Information

Thank you for purchasing Iqua miniUFO Bluetooth® Portable Handsfree. Your new device is a stylish product that enables you to communicate comfortably with compatible mobile phones that support Bluetooth wireless technology. In addition to being light and pocket-sized, it has been designed for use in the car, at the office, or at home. You can charge the device in your car with the car charger, which has a removable USB charging cable and is included in the sales package.

### Overview of the product

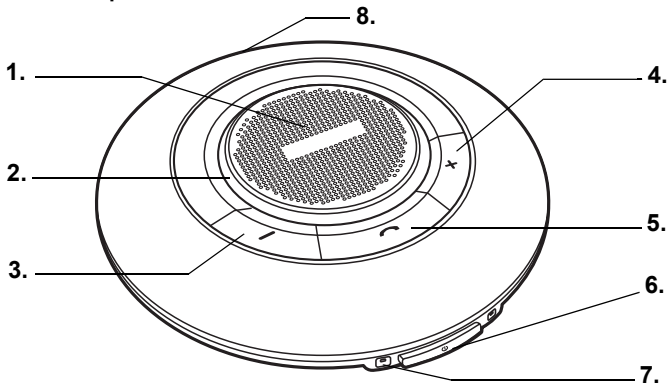

**1. Loudspeaker**

**2. Indicator Light**

Indicates status with blue and red lights

**3.  Volume Down button**

Decreases the volume

**4.  Volume Up button**

Increases the volume

**5.  Call button**

Answer a call, end a call, reconnect to phone, or switch between handsfree and phone mode

**6.  Power button**

Switch the device on/off

**7. Microphone**

**8. Charger connector**

## Sales package content

1. miniUFO

2. Sunvisor clip

3. Mounting plate with  
double-sided sticker

4. Car charger with  
removable USB  
charging cable

5. User Guide

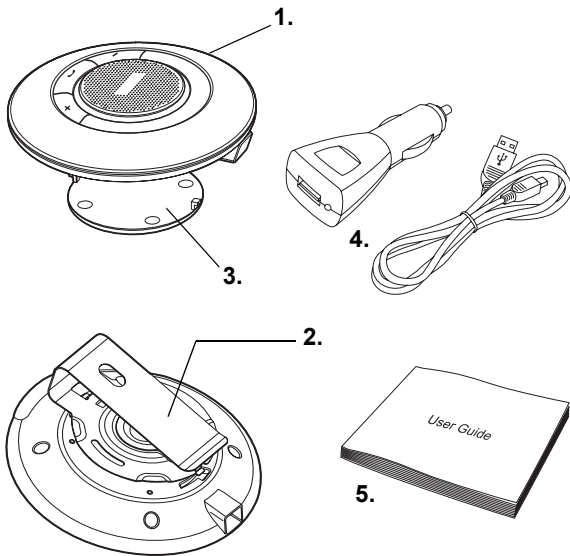

# Getting Started

## Safety

- Always concentrate on traffic safety while driving and obey the law.
- The miniUFO is not a toy. Keep it away from small children since it contains small parts that may pose a choking hazard.

## Car Installation

You can attach your miniUFO to the sunvisor of your car with the sunvisor clip as shown in Fig. 1 and 2. Alternatively, you can use the mounting plate that has a double-sided sticker to attach it to the dashboard as shown in Fig. 3. **Make sure that the product is not in the operating area of any side impact airbags or any of the other safety or operating equipment in your car. In addition, check that the product is securely fastened and does not interfere with you being able to operate the vehicle.**

Fig. 1.

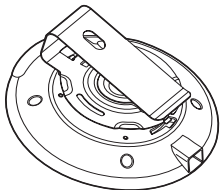

Fig. 2.

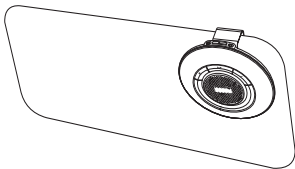
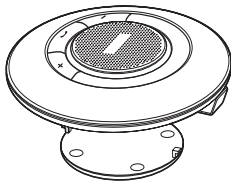

Fig. 3.



## Charging the battery

Before using the miniUFO, you must charge it for approximately 4 hours. Once the battery is fully charged, it will provide up to 10 hours of talk time and up to 450 hours of standby time. Always use the charger that comes in the sales package.

1. Connect the charger cable to the miniUFO.
2. Plug the car charger into the cigarette lighter in your car. The red and blue lights will turn on.
3. The red light will turn off once the battery is fully charged.

You can also use the removable USB charging cable for charging the miniUFO from your PC, which will take longer to charge as the power output of the USB port is lower than it is with the car charger. The miniUFO indicates that its battery is low with a warning sound and a flashing red light.

Once the charger is connected, the miniUFO turns itself off. Press the **(i)** button to turn the miniUFO back on.

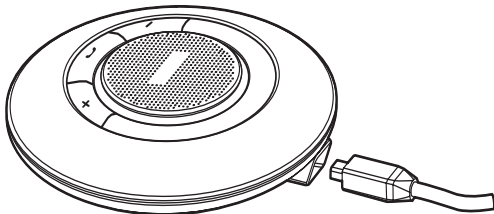



## Switching on and off

To switch on the miniUFO:

- Press and hold the **ⓘ** button until the blue light starts blinking (1 blink every 3 seconds).
- To switch off the miniUFO, press and hold the **ⓘ** button until the lights stop blinking.

## Pairing the miniUFO and a mobile phone

Pairing is the process of linking your miniUFO to a Bluetooth-enabled mobile phone. Once this process is over, you will be able to use the miniUFO with the mobile phone you have paired it to. If you want to use the miniUFO with another mobile phone, you must repeat the pairing process again. Even though the miniUFO can be paired with up to 8 compatible phones, it can only be connected to one phone at a time.

1. Press and hold down the **ⓘ** button until you hear a sound and the blue and red lights start flashing in turns.
2. Release the button. The miniUFO is now in pairing mode and is waiting for your mobile phone to contact it.
3. Complete the pairing with your mobile phone. Please refer to your mobile phone's manual for details on how to search and pair. Once the mobile phone has found the handsfree device, the phone will show **Iqua miniUFO** on its display. In order to pair with the phone, enter the PIN code of the miniUFO, which is **0000**.
4. After it has paired, the miniUFO will automatically connect to your mobile phone. Once they have been successfully paired and connected, you will hear a sound and the blue light will start flashing (3 flashes every 2 seconds).

## Disconnecting the miniUFO from a phone

To disconnect the miniUFO from the phone it is connected to, do one of the following:

1. Switch off the miniUFO.
2. Disconnect the miniUFO from the phone it is connected to in the phone's menu.
3. Move the phone more than 10 meters away from the miniUFO.

## Reconnecting the paired miniUFO to a phone

To reconnect the miniUFO to the last phone used, simply switch on the miniUFO and it will automatically connect to the phone. If the miniUFO is already on, you can reconnect to the last phone used by pressing the  button of the miniUFO. Otherwise, make the connection in the phone menu as instructed in your phone's user guide.

# Call Functions

## Answer a call

When there is an incoming call, you will hear the mobile phone's ringing tone through the miniUFO speakers. To answer a call, just press the  button.

## End a call

To end an active call, press the  button briefly.



## Reject a call

When you receive an incoming call that you do not want to answer, simply press the  button for 3 seconds.

## Redialing the last number dialed

To place a call to the last number dialed, press the  button for 3 seconds.



## Adjusting volume

Adjust the volume by pressing the  and  buttons respectively.



## Voice dialing (when supported by the phone)

To activate the voice dialing feature of your phone, press the  button for 3 seconds. Please refer to your phone's user guide for additional details, especially as some phone models do not support voice dialing. For optimal performance, connect your phone to the miniUFO before recording voice tags.

## Muting an active call



You can mute or unmute the miniUFO during an ongoing call by pressing the  and  buttons at the same time.

## Switching the call between phone and handsfree mode

To transfer an active call from the miniUFO to your mobile phone, press and hold down the  button until the call is transferred to your phone. To transfer an active call from your mobile phone to the miniUFO, press the  button or use the functions of your phone as instructed in its user guide.

## Advanced Call Functions

If your mobile phone has call waiting or conference functions, you can do the following with the miniUFO:

1. A new call comes in during another call:
  1. Press the **+** button for 3 seconds to put the current call on hold and accept the incoming call.
  2. Press the  button to end the current call and answer the new call.
2. Two calls, one active and the other on hold:
  1. Press the **+** button for 3 seconds to toggle between the call on hold and the active call.
  2. Press the  button to end the active call and accept the call on hold.
  3. Press the **=** button for 3 seconds to merge the calls into a conference call.

## Light indication summary

The miniUFO's LED lights can be either blue or red and are usually accompanied by a sound signal.

The different signals indicate:

- Blue light flashing once every 3 seconds – power is on, no Bluetooth-connection.
- Blue light flashing three times every 2 seconds – power is on, Bluetooth-connection is open.
- Blue and red light flashing in turns – in pairing mode, waiting for user to complete pairing with mobile phone.
- Red light flashing every 3 seconds – low battery.
- Red and blue light stay on – the battery is charging.
- Blue light on continuously – charger connected, battery fully charged.

## Product Specifications

Model:	PHF-301
Size:	98.6mm (L) x 98mm (W) x 27.5mm (H)
Weight:	81 g
Talk Time:	Up to 10 hours
Standby Time:	Up to 450 hours
Charging Time:	Approx. 3 hours
Supports:	Bluetooth
Profiles:	Handsfree 1.0 and Headset 1.1
Bluetooth Compliance:	Bluetooth 1.2 specification
Connection:	Point-to-point
Paired Devices:	Up to 8 paired, one connected at a time
Battery:	Lithium Polymer (LiPo) rechargeable battery 900 mAh
Speaker:	Max 1,5W
Operating Temperature:	-30°C to +55°C (-22°F to +131°F)
Operating Range:	Up to 10 meters
Sales Package Contents:	miniUFO, LiPo battery (inserted), sunvisor clip, mounting plate with double-sided sticker, car charger (with removable USB charging cable), user guide

## Battery Information

- Do not expose the product to temperatures above 80°C (175°F), direct sunlight, or fire.
- Do not attempt to replace the battery by yourself as it is built-in and cannot be changed.
- Do not dismantle the charger as it may expose you to dangerous voltages or other hazards.
- Please charge the device only with the chargers provided by the manufacturer.
- Incorrectly reassembling the device can cause electric shock when it is used again.
- Do not use the charger outdoors or in a humid environment.
- Avoid charging the device in extremely high or low temperatures.

Leaving the battery in hot or cold places, such as in a closed car in summer or winter conditions, will reduce the capacity and lifetime of the battery and its ability to charge. Always try to keep the battery between 15°C and 25°C (59°F and 77°F). A device with a hot or cold battery may not work for a while, even when the battery is fully charged. Battery performance is particularly limited in temperatures well below freezing.



## Care and Maintenance

- Do not expose the device to liquid, moisture or humidity as it is not waterproof.
- Do not use or store the device in dusty, dirty areas. Its moving parts and electronic components can be damaged.
- Do not store the device in hot areas. High temperatures can shorten the life of electronic devices, damage batteries, and warp or melt certain plastics.
- Do not store the device in cold areas. When the device returns to its normal temperature, moisture can form inside the device and damage electronic circuit boards.
- Do not drop, knock, or shake the device. Rough handling can break internal circuit boards and fine mechanics.
- Do not use harsh chemicals, cleaning solvents, or strong detergents to clean the device.
- Use a soft, clean, dry cloth to clean any lenses.
- Do not expose your device to contact with sharp objects as this will cause scratches and damage.
- Do not stick anything inside the device as this may damage internal components.
- Do not attempt to take apart the device as it does not contain serviceable components.

## Correct disposal of this product

(Applicable in the European Union and other European countries with separate collection systems)



This symbol, shown on the product or its literature, indicates that it should not be disposed of with other household wastes at the end of its working life. To prevent harming the environment or human health from uncontrolled waste disposal, please separate this from other types of wastes and recycle it responsibly to promote the sustainable reuse of material resources. Household users should contact either the retailer where they purchased this product or their local government office for details on where and how they can take this item for environmentally safe recycling. Business users should contact their supplier and check the terms and conditions of the purchase contract. This product should not be mixed with other commercial wastes for disposal.

## 12 MONTH LIMITED WARRANTY

The Iqua standard warranty (IQUA Ltd.) guarantees that this product is free from material and workmanship defects for a period of twelve (12) months from date of purchase provided the following terms of this warranty are satisfied. This warranty only applies to the original owner of this product. The length of warranty may vary from country to country, however, so please check with your retailer for more details.

1. The purchaser must be able to prove that he or she purchased the product by presenting the original sales receipt that describes the product in order to establish the validity of the warranty claim to IQUA Ltd. with the provider of warranty service. IQUA Ltd. reserves the right to deny warranty without dated proof-of-purchase. Any evidence of alteration, erasure, or forgery shall result in termination of the right of warranty.
2. IQUA Ltd. agrees to repair or replace, without charging the owner, any defective product that is still under warranty. Said warranty does not apply to cases where the owner has used product accessories, such as chargers, other than those supplied by Iqua with this product.
3. Replacement or repair does not extend the original warranty period.
4. This warranty is not valid for product owners who attempt to repair defective units themselves.
5. Certain product liability regulations may apply to you as the owner of the Product; however, under no circumstances is IQUA Ltd. liable for any indirect or consequential damages to person or property resulting from the use of any IQUA product.

6. The warranty is not valid in case of fire, lightning, earthquake, accident, misuse, unusual physical or electrical stress or any other cause beyond the normal usage and care of the product.
7. IQUA Ltd. reserves the right to make changes or improvements in design or manufacture without having any obligation to install such changes in existing and sold products.
8. This warranty does not cover normal wear and tear on the product or the operation time of the battery.

## DECLARATION OF CONFORMITY

We, Iqua Ltd., declare under our sole responsibility, that the product, PHF-301, conforms with the provisions of the following Council Directive: 1999/5/EC.



[www.iqua.com](http://www.iqua.com)

Download from [Www.Somanuals.com](http://Www.Somanuals.com). All Manuals Search And Download.

## Free Manuals Download Website

<http://myh66.com>

<http://usermanuals.us>

<http://www.somanuals.com>

<http://www.4manuals.cc>

<http://www.manual-lib.com>

<http://www.404manual.com>

<http://www.luxmanual.com>

<http://aubethermostatmanual.com>

Golf course search by state

<http://golfingnear.com>

Email search by domain

<http://emailbydomain.com>

Auto manuals search

<http://auto.somanuals.com>

TV manuals search

<http://tv.somanuals.com>