



*Compact Monochrome Megapixel
Progressive Scan Camera*

CV-A1-20

Operation Manual

*Camera: Revision B
Manual: Version 1.1*

Table of Contents

| | |
|---|----|
| 1. General..... | 2 |
| 2. Standard Composition | 2 |
| 3. Main Features | 2 |
| 4. Locations and Functions..... | 3 |
| 5. Pin Assignment..... | 4 |
| 5.1. 12-pin Multi-connector (DC-IN/VIDEO OUT, EXT.HD/VD IN) | 4 |
| 5.2. 6-pin Multi-connector (TRIGGER)..... | 4 |
| 5.3. Input and Output Circuits | 5 |
| 5.3.1. Video output | 5 |
| 5.3.2. Trigger input | 5 |
| 5.3.3. HD and VD input..... | 5 |
| 5.3.4. HD, VD, PCLK, WEN and EEN output | 5 |
| 5.4. CV-A1 Block Diagram | 6 |
| 6. Functions and Operations | 6 |
| 6.1. Basic functions | 6 |
| 6.2. Input-output of HD/VD Signals | 8 |
| 6.3. Continuous Operation (Non triggered) | 9 |
| 6.4. External Trigger Modes | 10 |
| 6.5. Edge Pre-select Mode | 11 |
| 6.6. Pulse Width Control Mode | 12 |
| 6.7. Frame-delay read out Mode..... | 13 |
| 6.8. Long Time Exposure Mode | 14 |
| 6.9. Start/Stop Mode | 15 |
| 6.10. Smearless Mode..... | 16 |
| 6.11. Other Functions..... | 17 |
| 7. Configuring the Camera | 17 |
| 7.1. RS-232C control. | 17 |
| 7.2. CV-A1-20 RS-232C command list. | 18 |
| 7.3. Camera Control Tool for CV-A1-20..... | 19 |
| 7.4. Internal Switch and Jumper Settings | 20 |
| 8. External Appearance and Dimensions | 20 |
| 9. Specifications | 21 |
| 10. Appendix | 22 |
| 10.1. Precautions..... | 22 |
| 10.2. Typical CCD Characteristics | 22 |
| 11. Users Record | 23 |

1. General

The CV-A1-20 is a monochrome progressive scan 1/2" CCD camera with 1.4 Megapixel resolution. CV-A1-20 is identical to CV-A1, but the pixel frequency is 20 MHz instead of 28.636 MHz. It is designed for automated inspection, featuring a small housing and a wide range of unique functions. The asynchronous trigger can be set to work in several modes, to allow such functions as pulse width controlled shutter, programmable shutter speed and long time integration. To obtain higher frame rates, the camera has partial scanning and both horizontal and vertical binning.

All modes and functions can be set via an RS-232C interface, greatly reducing the need for mechanical switches or jumpers.

CV-A1-20 Camera Control Tool for Windows 98/NT/2000 contains a camera control program and tools for making your own program.

Camera ID, model name and user ID is present in the camera from revision B. S/N E121231.

The latest version of this manual can be downloaded from: www.jai.com

The latest version of Camera Control Tool for CV-A1-20 can be downloaded from: www.jai.com

2. Standard Composition

The standard camera composition consists of the camera main body and operation manual.

3. Main Features

- New compact size 1/2" progressive scan monochrome CCD camera
- 11 full frames 1392 (h) x 1040 (v) 4.65 μ m square pixels per second
- Up to 52 fps with 1/6 partial scan.
- Double speed and double sensitivity with V binning
- 4 times normal sensitivity with H and V binning
- Internal, external HD/VD or random trigger synchronization
- Edge pre-select, programmable shutter and pulse width control trigger modes
- Start/stop mode (trigger/ext. VD) and long time exposure (ext. VD interval)
- Shutter speeds from 1/11 to 1/140,000 second in continuous mode
- Triggered shutter speed up to 1/8381 second
- Programmable shutter speed from 1.3 H to 1023.3 H
- Pulse width controlled shutter 1.3 H to 2000 H
- H synchronized or H non-synchronized accumulation in PWC mode
- Frame delay readout 1.3 H to 2000 H for pulse width controlled shutter
- Smear-less readout mode for edge pre-select and programmable shutter
- Exposure enable EEN, write enable WEN and pixel clock output
- Short ASCII commands for fast mode set-up via serial port
- Set-up by Windows 98/NT/Win2000 software via RS 232C
- Compact housing with C-mount

4. Locations and Functions

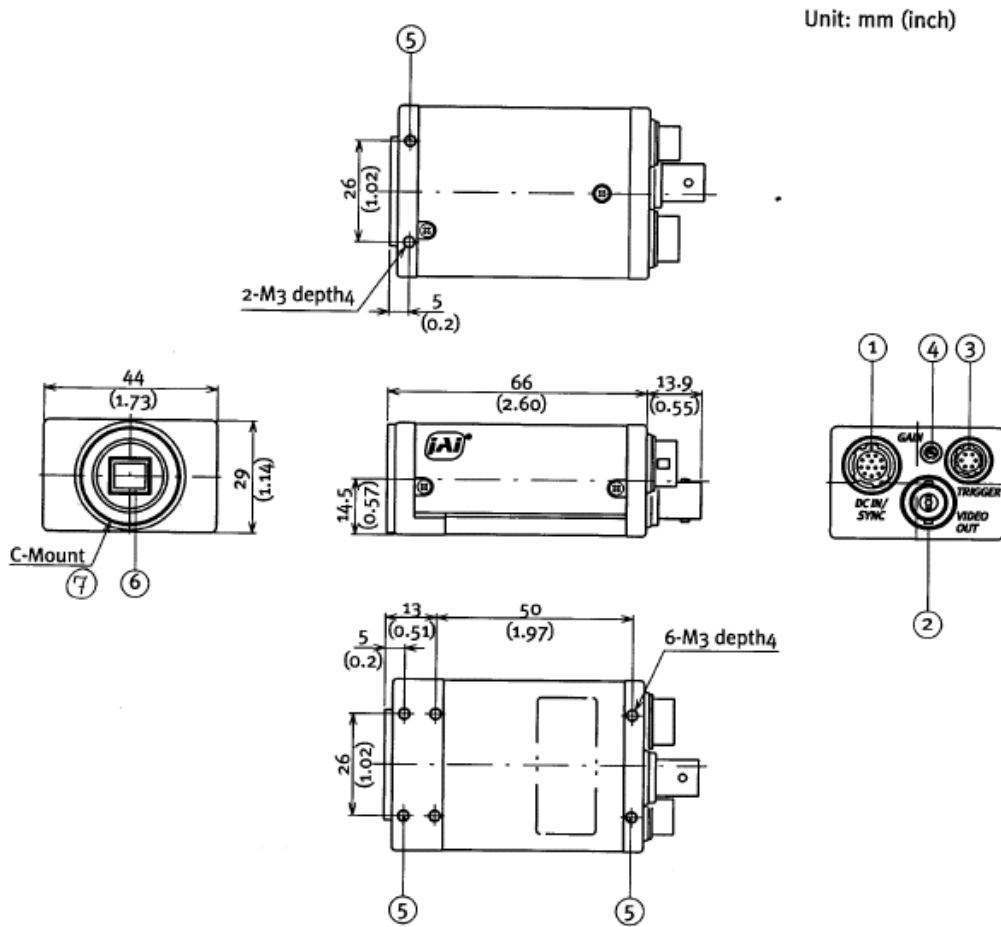

Fig. 1. Locations.

1. 12 pin Hirose connector for frame grabber interfacing and power (12V DC).
2. BNC connector for video output. VS 1.0 Vpp 75 Ohm.
3. 6 pin Hirose connector for trigger input and RS-232C control interface.
4. Gain potentiometer for manual gain setting.
5. Mounting holes, 8 x M3. For precision mounting use only the 4 holes located at the forward part of the bottom plate.
6. 1/2" interline-transfer type CCD sensor.
7. Lens mount for C-mount lenses. *1)

Note: *1) Rear protrusion on the C-mount lens must be less than 10mm (0.4 inches approx.). When IR-cut filter is used, it must be less than 7.0 mm (0.28 inches approx.).

The IR-cut filter is placed in the C-mount thread.
The C-mount IR-cut filter must be ordered separately.

5. Pin Assignment

5.1. 12-pin Multi-connector (DC-IN/VIDEO OUT, EXT.HD/VD IN)

Type: HR10A-10R-12PB-01 (Hirose) male

Seen from rear.

Pin configuration is compatible with EIAJ standard

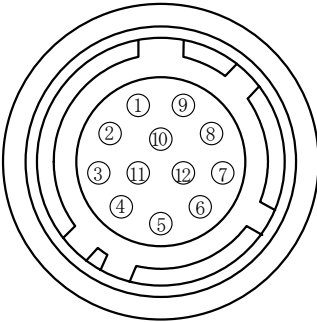

| Pin no. | Signal | Remarks |
|---------|-----------------------------------|---|
| 1 | GND | |
| 2 | +12 V DC input | |
| 3 | GND | |
| 4 | Video output | Parallel with the BNC connector. |
| 5 | GND | |
| 6 | <i>HD input</i> /HD output | *) SW2.1 on for 75Ω. SW1.1 on for HD out. |
| 7 | <i>VD input</i> /VD output | *) SW2.2 on for 75Ω. SW1.2 on for VD out. |
| 8 | GND | |
| 9 | Pixel clock output | *) JP2 short and PC=1 for pclk out. |
| 10 | <i>WEN output</i> | *) GND if JP5 open and JP3 short |
| 11 | <i>Trigger input</i> | *) +12V DC if JP1 short and JP4 open |
| 12 | GND | |

Fig. 2. 12-pin connector.

Plugs for cable: HR10A-10P-12S

5.2. 6-pin Multi-connector (TRIGGER)

Type: HR10A-7R-6PB (Hirose) male

Seen from rear.

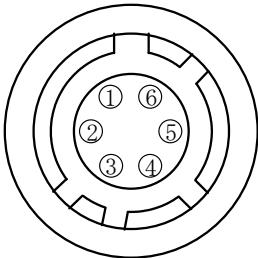

| Pin no. | Signal | Remarks |
|---------|-----------------------------|---------------------------------------|
| 1 | TXD out | |
| 2 | RXD in | |
| 3 | GND | |
| 4 | GND | |
| 5 | <i>Trigger input</i> | *) Parallel with pin 11 on 12 pin con |
| 6 | <i>EEN output</i> | *) *2). WEN output if EW=1 |

Fig. 3. 6-pin connector.

Plugs for cable: HR10A-7P-6S

Notes.

*) Alternative signals can be placed on these pins by switch or jumper settings or RS-232C commands.
Configurations shown in ***Bold + italic*** is factory setting.

*2) EEN will be low all the time in normal continuous mode (TR=0), if the selected exposure time is longer than the frame readout time.

5.3. Input and Output Circuits

In the following schematic diagrams the input and output circuits for video and timing signals are shown. For alternative connections refer to "7.4. Internal Switch and Jumper Settings." Jumper settings are shown as for factory default.

5.3.1. Video output

The video output is a 75 Ω DC coupled circuit. The BNC connector and pin #4 on the 12-pin connector is in parallel. Avoid double termination. The video DC level is shown with 75 Ω termination.

In the composite signal, there are no equalize and serration pulses in the vertical sync.

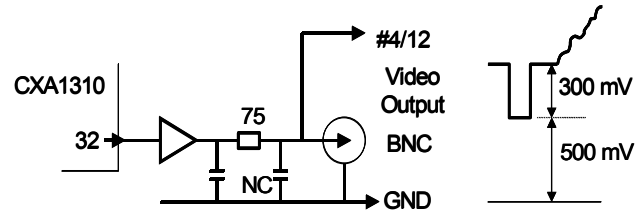

Fig. 4. Video output.

5.3.2. Trigger input

The trigger input is AC coupled. To allow a long pulse width, the input circuit is a flip flop, which is toggled by the negative or positive differentiated spikes caused by the falling or rising trigger edges.

The trigger polarity can be changed.

Trigger input level 4 V ± 2 V.

The trigger-input impedance is 1 kΩ.

JP1 and JP4 are for alternative configuration for pin #10.

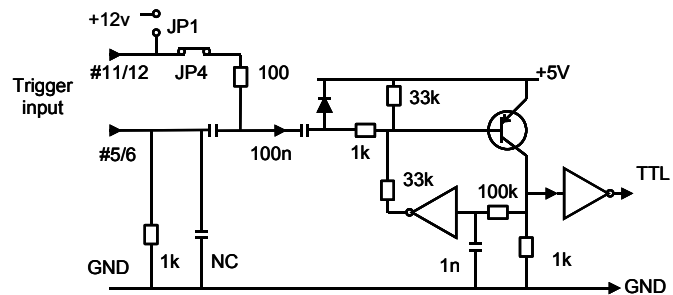

Fig. 5. Trigger input.

5.3.3. HD and VD input

The input circuit for external HD and VD signals are shown. It can be 75 Ω terminated by closing SW2. SW1 will switch to output the internal HD and VD signal.

HD and VD input level is 4 V ± 2 V.

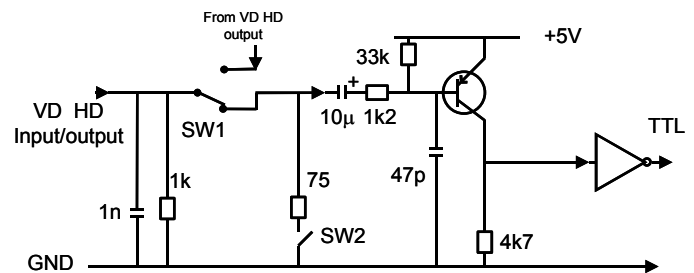

Fig. 6. HD and VD input.

5.3.4. HD, VD, PCLK, WEN and EEN output

Output circuit for these signals are 75 Ω complementary emitter followers. It will deliver a full TTL signal. JP5 and JP3 are for alternative configuration for pin #10.

Output level ≥ 4 V from 75Ω. (No termination).

The WEN polarity can be changed.

Signal on pin #6/6 can be changed.

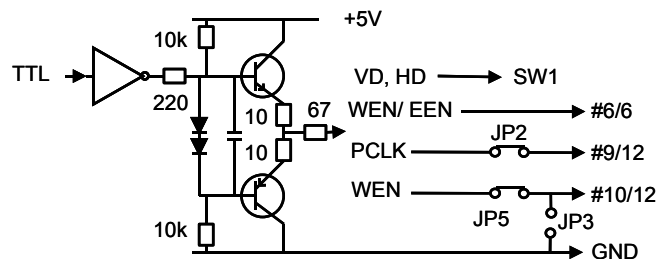

Fig. 7. HD, VD, PCLK, WEN and EEN output.

5.4. CV-A1 Block Diagram

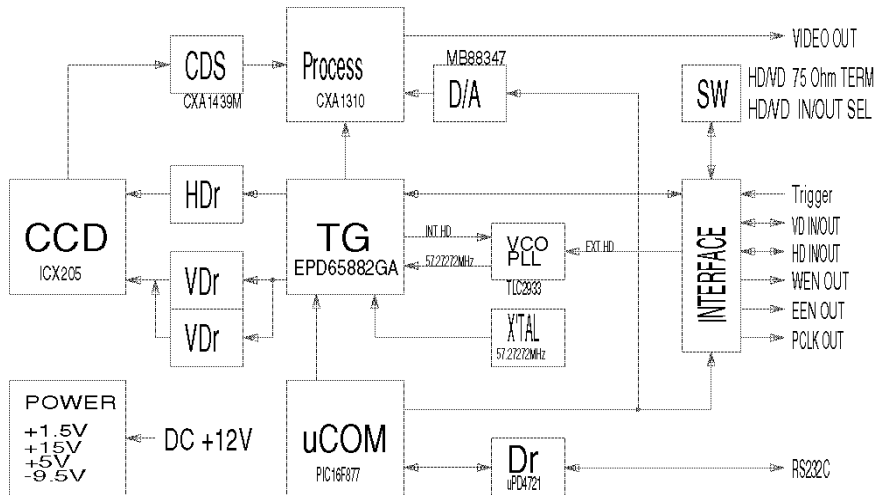

Fig. 8. Block diagram.

6. Functions and Operations

6.1. Basic functions

Some of the primary camera functions need a general introduction before the operation modes are described. The list below shows the primary functions from the command list.

| | | |
|----|-----------------------|--|
| SM | Shutter Mode | Normal shutter, Programmable Exposure |
| SH | Shutter Speed | Off to 1/140,000 second |
| PE | Programmable Exposure | 1.3 H to 1023.3 H |
| SC | Scanning Format | Full frame, 1/2 partial, 1/3, 1/6 partial |
| BI | Binning | Off, vertical, horizontal, vertical + horizontal |
| TR | Trigger Mode | Normal, Edge, PWC, frame delay readout |
| | | Long time exposure, start-stop, smearless (Edge) |
| HC | HD Accumulation | Sync., async. |

The shutter **SM** can be set to normal ($SM=0$), where the exposure time is selected from 16 fixed step with the command **SH**, or programmable exposure ($SM=1$). The command **PE** allows 1023 step with 1 line period resolution. (83.6 μ s). Note that $PE=0$ and $PE=1$ results in 1.3H. The CCD scanning format **SC** can be selected between full or partial scanning. With partial scanning, only the vertical central part of the CCD sensor is read out with a higher frame rate. The partial scan is done by a fast dump read out of the lines in the vertical ccd register down to the top of the partial image. The partial part of the image is read out with normal speed. The lines below the partial image are read out and dumped with a high speed. Some signal distortion can be expected below highlighted areas, (saturated areas). It is caused by limitation in the vertical ccd register transfer efficiency at high speed.

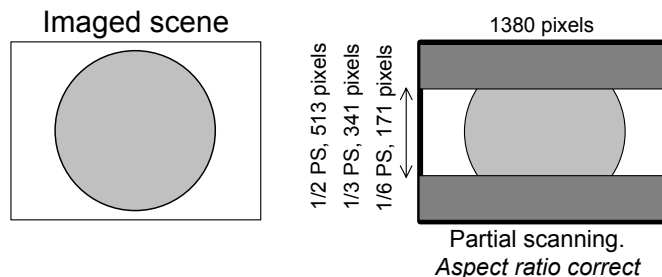

Fig. 9. Partial scanning.

Binning mode **BI** is a function where the signal charge from 2 or more adjacent pixels are added together and read out as one pixel. A resulting full frame with lower resolution can be read out with a higher rate. By adding 2 pixels together, the sensitivity is doubled. The CV-A1-20 has both vertical and horizontal binning. With V binning the pixel charge from 2 adjacent lines are added together in the horizontal ccd register. It is done by double pulses to the vertical ccd register. With H binning the pixel charge from 2 horizontal adjacent pixels are added together in the sample/hold circuit after the horizontal ccd register. It is done by shifting the charge from 2 horizontal ccd cells into the sample/hold capacitor for each reset pulse. Both vertical and horizontal binning can work together. The sensitivity is then 4 times normal. The aspect ratio will be correct, if the sampling frequency is divided with 2. See fig. 10.

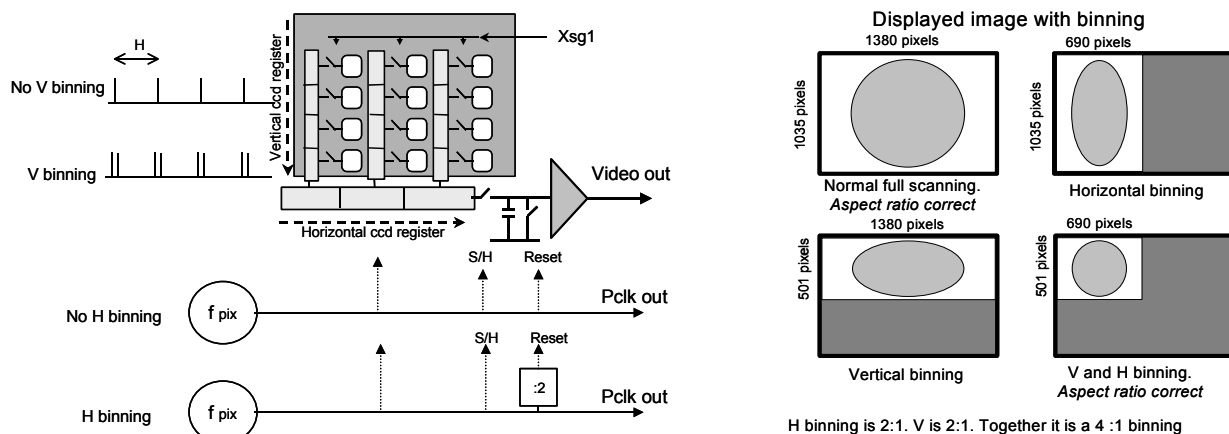

Fig. 10. Binning.

The accumulation mode **HC** can be set to asynchronous accumulation (HC=1). The exposure in PWC mode (TR=2) and Frame Delay readout (TR=3) will start immediately at the leading edge of the trigger pulse without waiting for the HD. Fig. 11 and fig. 12 shows the details.

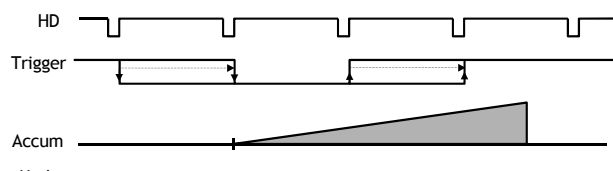

Fig. 11. PWC H synchronous accumulation

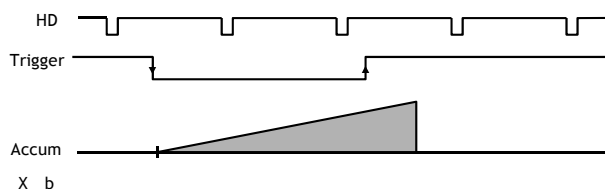

Fig. 12. PWC asynchronous accumulation

In normal trigger mode (TR=0) shutter speed up to 1/140,000 sec. can be used. In all triggered shutter modes, the shortest shutter time is limited to $\geq 1,3 H$. (1/8381). In triggered shutter modes with partial scan or binning, the longest shutter speed is not limited by the frame read out time. It can be longer.

Trigger modes with possible scanning and binning combinations

| TR= | Scanning | Full scanning | | | | Partial scanning | | | | Remarks |
|-----|----------------|---------------|---|---|-----|------------------|---|---|-----|-------------------|
| | Binning | norm. | V | H | V+H | Norm | V | H | V+H | |
| 0 | Normal | √ | √ | √ | √ | √ | n | n | n | SM=0, SM=1 active |
| 1 | Edge Pre-sel. | √ | √ | √ | √ | √ | n | n | n | SM=0, SM=1 active |
| 2 | Pulse Width | √ | √ | √ | √ | √ | n | n | n | HC=0, HC=1 active |
| 3 | Fr. Delay r.o. | √ | √ | √ | √ | √ | n | n | n | HC=0, HC=1 active |
| 4 | Long Time int | √ | n | n | n | n | | | | |
| 5 | Start/Stop | √ | | | | | | | | |
| 6 | Smearless | √ | √ | √ | √ | √ | n | n | n | SM=0, SM=1 active |

√ Described mode
 n Non-described mode combination, which will work

6.2. Input-output of HD/VD Signals

In the default setting the camera will accept external HD/VD signals on pin 6 and 7 of the 12 pin Hirose connector. If external HD/VD is applied, the camera will synchronize to it. If no external sync signals are applied, the camera will operate with its internal x-tal controlled sync. The camera scanning system should be set to the same as the external connected sync. In fig. 13 below, the time requirements to relation between VD and HD are shown. The high to low transition for the external VD pulse should be placed within the 68 μ sec. time interval to HD. The input is TTL level as factory setting. It can be 75 Ohm terminated by the internal switch on the PK8342A board. SW2-1 for HD and SW2-2 for VD. On for 75 Ohm termination. To output the internal HD/VD signals on pin 6 and 7 the internal switch SW1-1 and 1-2 on the PK8342A board should be set ON. The output is TTL level from a 75-Ohm source. Fig. 14 below shows the switch positions.

To use this mode:

Set function:

SW 1 on PK8342A to IN for external VD/HD input. *Factory default.*
 SW 2 on PK8342A to 75 Ω for termination of VD/HD.
 SW 2 on PK8342A to TTL for TTL level for VD/HD. *Factory defaults.*
 SW 1 on PK8342A to OUT for internal VD/HD output.

Input:

Ext. VD in or int. VD out on pin 7 on 12-pin connector.
 Ext. HD in or int. HD out on pin 6 on 12-pin connector.

Important notes on using this mode

External sync system should follow the camera scanning and binning system.
In trigger modes there are no continuous VD out, only after each trigger input.

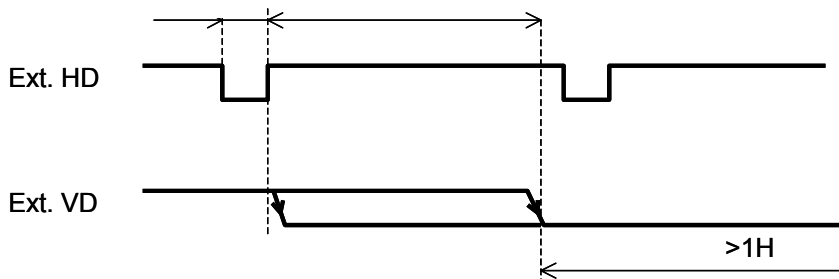

Fig. 13. Ext. HD and ext. VD phase conditions.

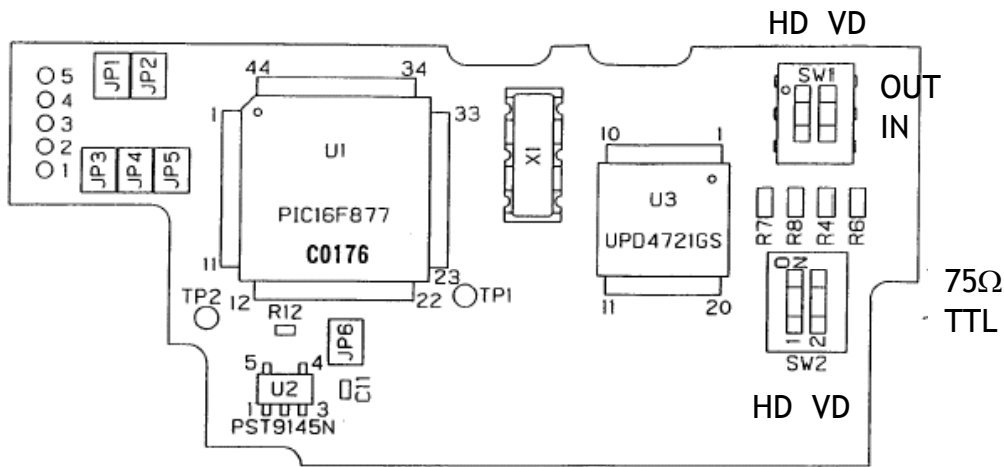

Fig. 14. Switch positions for int./ext. sync and termination.

6.3. Continuous Operation (Non triggered)

Trigger Mode Normal. TR=0. It is for applications where the camera is continuous running without external trigger. In normal mode the shutter mode can be normal or programmable exposure. (SM=0 SM=1). The shutter will work in all 16 steps up to 1/140,000 second or with the programmable exposure in 1023 steps. In partial scanning and binning modes, shutter times longer than the actual frame time has no meaning. The exposure will be equal the frame time. If external synchronizing is used input external HD and VD signals.

To use this mode:

| | | |
|---------------|--|-------------------|
| Set function: | Trigger mode | TR=0 |
| | Shutter mode "Normal" or "Programmable" | SM=0, SM=1 |
| | "Shutter Speed" | SH=0 through 15 |
| | "Programmable exposure" | PE=1 through 1023 |
| Input: | Ext. VD on pin 7 on 12-pin connector. If used. | |
| | Ext. HD on pin 6 on 12-pin connector. If used. | |

Important notes on using this mode

External sync system should follow the camera scanning and binning system.

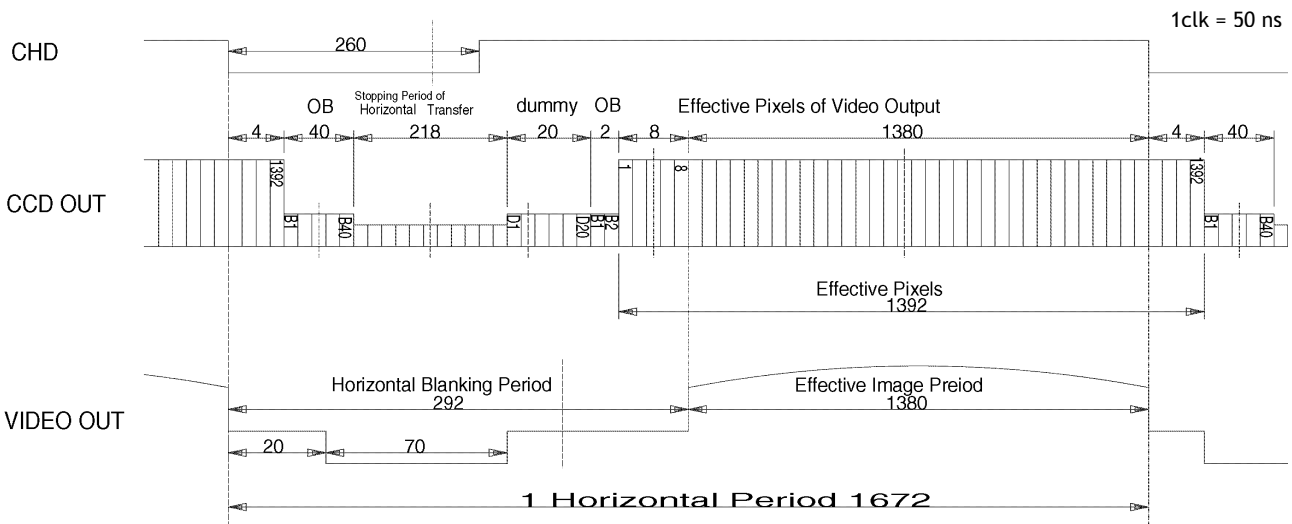

Fig. 15. Horizontal timing details and pixel numbering for the CCD array.

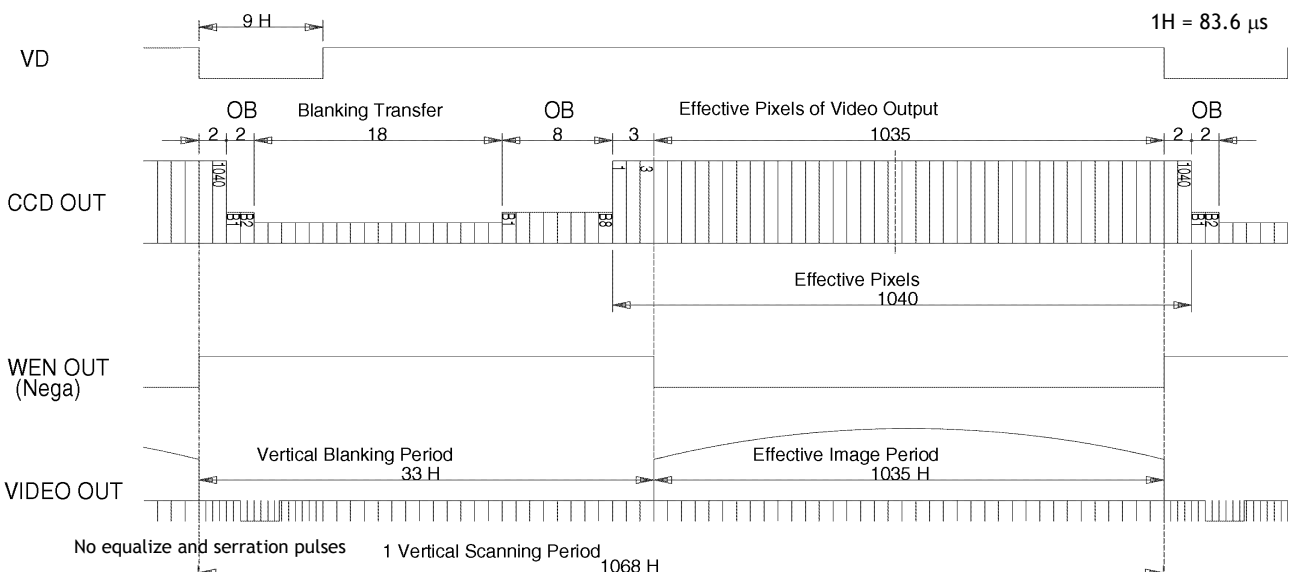

Fig. 16. Vertical timing details and lines numbering for the CCD array.

6.4. External Trigger Modes

This camera has 6 external asynchronous trigger modes, which can be set by RS-232C commands.

- | | |
|---|---|
| 1. <i>Edge Pre-select Mode. TR=1</i> | Pre-selected exposure. (SM=0, SM=1) |
| 2. <i>Pulse Width Control Mode. TR=2</i> | Pulse width controlled exposure. (HC=0, HC=1) |
| 3. <i>Frame Delay read out mode. TR=3</i> | PWC exposure read out by ext. VD. (HC=0, HC=1) |
| 4. <i>Long Time Exposure Mode. TR=4</i> | Exposure is interval between ext. VD. |
| 5. <i>Start/stop Mode. TR=5</i> | Exposure start by trigger and stop by ext. VD |
| 6. <i>Smearless Read out mode. TR=6</i> | Pre-sel. exp. after dummy readout. (SM=0, SM=1) |

The default accumulation is HD synchronously accumulation (HC=0). The accumulation starts at the first HD after the trigger leading edge. Fig. 18. To avoid the $<1H$ jitter caused by this delay, synchronize the external trigger to HD as shown in fig. 17 below. The trigger level translations should be placed inside the $8 + 4 \mu\text{s}$.

In PWC mode (TR =2) and Frame Delay readout (TR=3), the accumulation mode *HC* can be set to asynchronous accumulation (HC=1). The exposure will start immediately at the leading edge of the trigger pulse without waiting for the HD. Fig. 19. below.

In Edge pre-select TR=1 and smearless TR=6, the shutter mode can be SM=0 or SM=1.

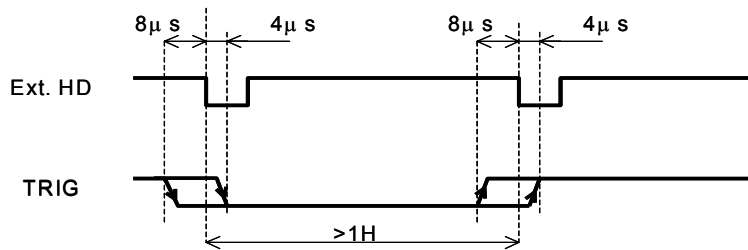

Fig. 17. Trigger/HD Timing.

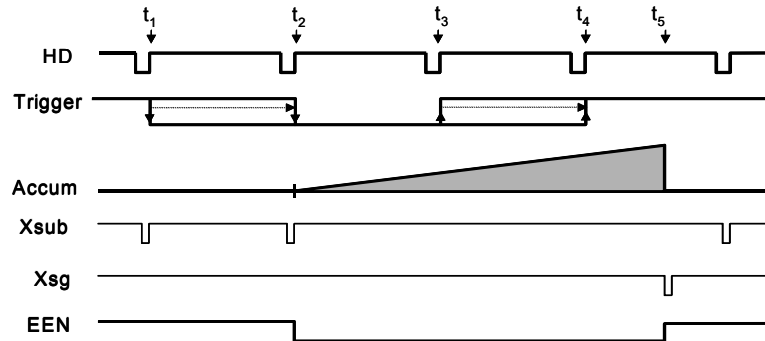

Fig.18. Pulse Width H Synchronous Accumulation

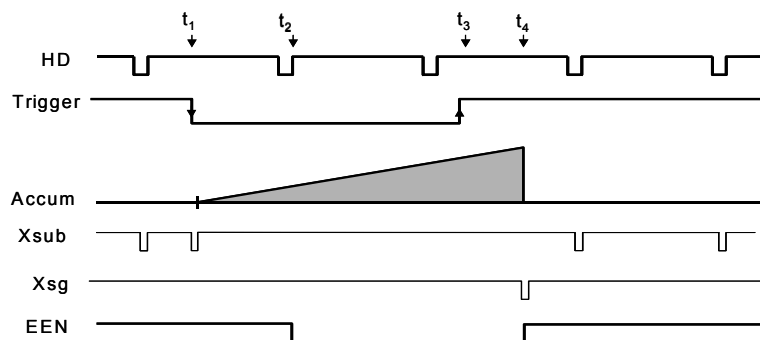

Fig. 19. Pulse Width H Asynchronous Accumulation.

Note: Xsg and Xsub are internal signals in the camera. They are shown in the timing diagram for better understanding.

6.5. Edge Pre-select Mode

The exposure starts at the first HD pulse after the trigger leading edge. It stops and is read out after the duration of the shutter time selected. It can be the first 9 step in normal or 1023 steps in programmable shutter. SM=0 or SM=1. Shutter selections SH ≥10 will result in 1/8381 sec. This mode will operate with full and partial scanning and with all binning modes. Partial scanning together with binning will work, but it is not described, and no timing diagrams are documented. An EEN pulse will indicate the active accumulation time, and a WEN pulse indicates that the resulting video is being read out.

To use this mode:

- Set function: Trigger mode "Edge Pre-select" TR = 1
 Shutter mode "Normal" or "Programmable" SM=0, SM=1
 "Shutter Speed" SH=0 through 9
 "Programmable exposure" PE=1 through 1023
 Polarity and other functions
- Input: Ext. trigger to pin 5 on 6 pin connector (or pin 11 on 12-pin connector).
 Ext. HD to pin 6 on 12-pin connector. (If used).

Important notes on using this mode.

- The start of exposure will start synchronized to the internal H signal. The start may be shifted max 1H. To avoid this shift (1 H jitter), synchronize the camera to an external HD and make sure that the trigger pulse aligns to the HD as shown in fig. 17.
- The duration of the trigger should be >1H to <2000H.
- A new trigger must not be applied before WEN is high.
- *In trigger modes there are no continuous VD out, only after each trigger input.*

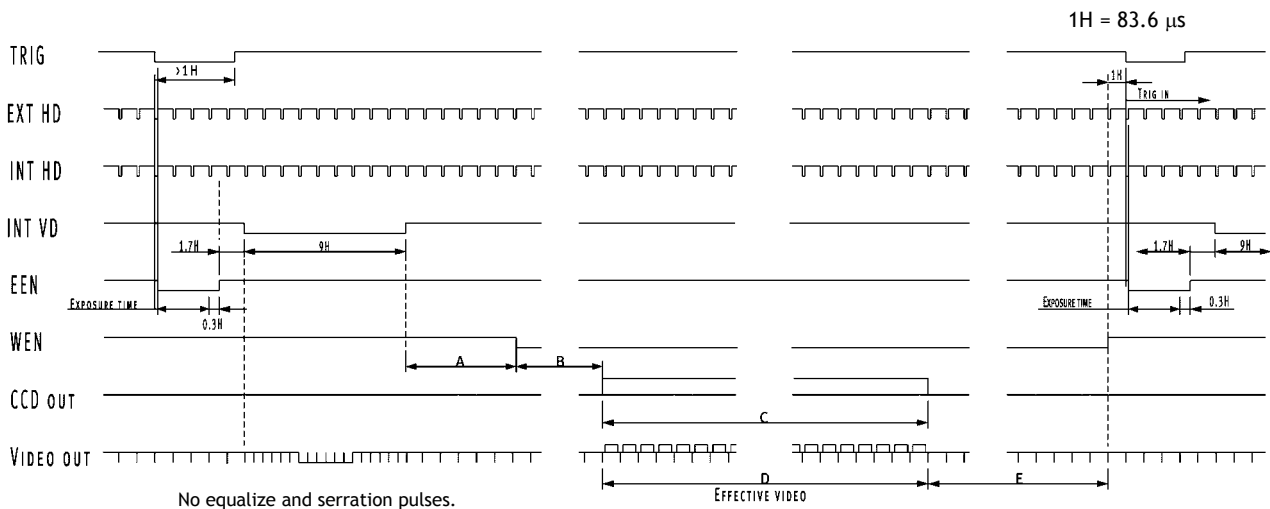

Table showing the figures for the different modes.

| Scan mode | A | B | C CCD array line # | D Effective video | E | Max frame rate fps | Remarks |
|-------------|-----|-----|-----------------------|----------------------|-----|-----------------------|---------|
| Full | 10H | 14H | 4 to 1038 | 1035H | 18H | 11 | |
| 1/2 Partial | 17H | 33H | 271 to 783 | 513H | 25H | 20 | |
| 1/3 Partial | 17H | 33H | 357 to 697 | 341H | 25H | 28 | |
| 1/6 Partial | 17H | 33H | 442 to 612 | 171H | 25H | 46 | |
| H binning | 10H | 14H | 4 to 1038 | 1035H | 18H | 11 | |
| V binning | 10H | 14H | 18 to 1019 | 501H | 18H | 22 | |
| V+H binning | 10H | 14H | 18 to 1019 | 501H | 18H | 22 | |

Fig. 20. Timing for Edge Pre-select with partial scanning and binning.

6.6. Pulse Width Control Mode

In this mode the exposure starts from the leading edge of the trigger pulse. It stops at the trailing edge of the trigger pulse, and the resulting video is read out. The accumulation can be either H synchronous or H asynchronous. HC=0 or HC=1. In H synchronous mode the accumulation starts at the first HD pulse after the leading edge of the trigger. It can result in <1H jitter if the trigger is not synchronized to H. In H asynchronous mode the accumulation starts immediately after the leading edge of the trigger. (The internal H is not reset.)

This mode will operate with full and partial scanning and with all binning modes. Partial scanning together with binning will work, but it is not described, and no timing diagrams are documented. An EEN pulse will indicate the active accumulation time, and a WEN pulse indicates that the resulting video is being read out.

To use this mode:

Set function: Trigger mode "Pulse Width Controlled" TR = 2
 "H accumulation" HC=0 or HC=1
 Polarity and other functions

Input: Ext. trigger to pin 5 on 6 pin connector (or pin 11 on 12-pin connector).
 Ext. HD to pin 6 on 12-pin connector. (If used).

Important notes on using this mode.

- With HC=0 the start of exposure will start synchronized to the internal H signal. The start may be shifted max 1H. To avoid this shift (1 H jitter), synchronize the camera to an external HD and make sure that the trigger pulse aligns to the HD as shown in fig. 17. With HC=1 the exposure will start immediately. Refer to fig. 18 and fig. 19.
- The duration of the trigger can be >1H to <2000H.
- A new trigger must not be applied before WEN is high.
- *In trigger modes there are no continuous VD out, only after each trigger input.*

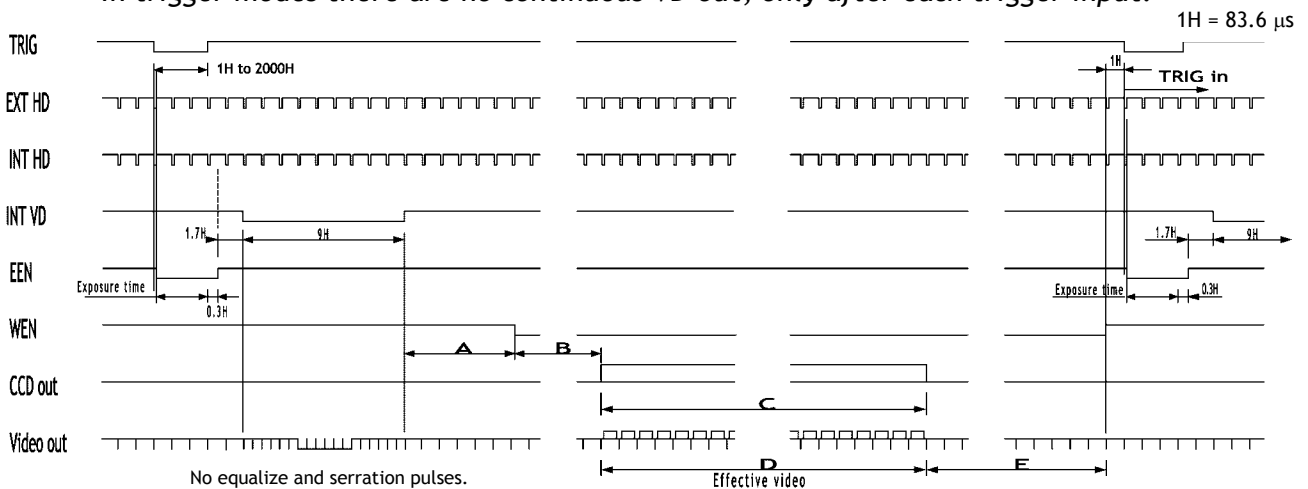

Table showing the figures for the different modes.

| Scan mode | A | B | C CCD array line # | D Effective video | E | Max frame rate fps | Remarks |
|-------------|-----|-----|-----------------------|----------------------|-----|-----------------------|---------|
| Full | 10H | 14H | 4 to 1038 | 1035H | 18H | 11 | |
| 1/2 Partial | 17H | 33H | 271 to 783 | 513H | 25H | 20 | |
| 1/3 Partial | 17H | 33H | 357 to 697 | 341H | 25H | 28 | |
| 1/6 Partial | 17H | 33H | 442 to 612 | 171H | 25H | 46 | |
| H binning | 10H | 14H | 4 to 1038 | 1035H | 18H | 11 | |
| V binning | 10H | 14H | 18 to 1019 | 501H | 18H | 22 | |
| V+H binning | 10H | 14H | 18 to 1019 | 501H | 18H | 22 | |

Fig. 21. Pulse Width Control trigger mode

6.7. Frame-delay read out Mode

In this mode the exposure starts from the leading edge of the trigger pulse. It stops at the trailing edge of the trigger pulse. The accumulation can be either H synchronous or H asynchronous. HC=0 or HC=1. In H synchronous mode the accumulation starts at the first HD pulse after the leading edge of the trigger. In H asynchronous mode the accumulation starts immediately after the leading edge of the trigger. (The internal H is not reset.) The resulting video is read out after an external VD pulse is applied. This mode will operate with full and partial scanning and with all binning modes. Partial scanning together with binning will work, but it is not described, and no timing diagrams are documented.

An EEN pulse will indicate the active accumulation time, and a WEN pulse indicates that the resulting video is being read out.

To use this mode:

- Set function: Trigger mode "Frame-delay read out" TR = 3
 "H accumulation" HC=0 or HC=1
 Polarity and other functions
- Input: Ext. trigger to pin 5 on 6 pin connector (or pin 11 on 12-pin connector).
 Ext. VD to pin 7 on 12-pin connector.
 Ext. HD to pin 6 on 12-pin connector. (If used).

Important notes on using this mode.

- With HC=0 the start of exposure will start synchronized to the internal H signal, the start of exposure may be shifted max 1H. To avoid this shift (jitter), synchronize the camera to an external HD and make sure that the trigger pulse aligns to the HD as shown in fig. 17.
- With HC=1 the exposure will start immediately. Refer to fig. 18 and fig. 19.
- The duration of the trigger can be >1H to <2000H.
- A new trigger must not be applied before WEN is high.
- *In trigger modes there are no continuous VD out, only after each trigger input.*

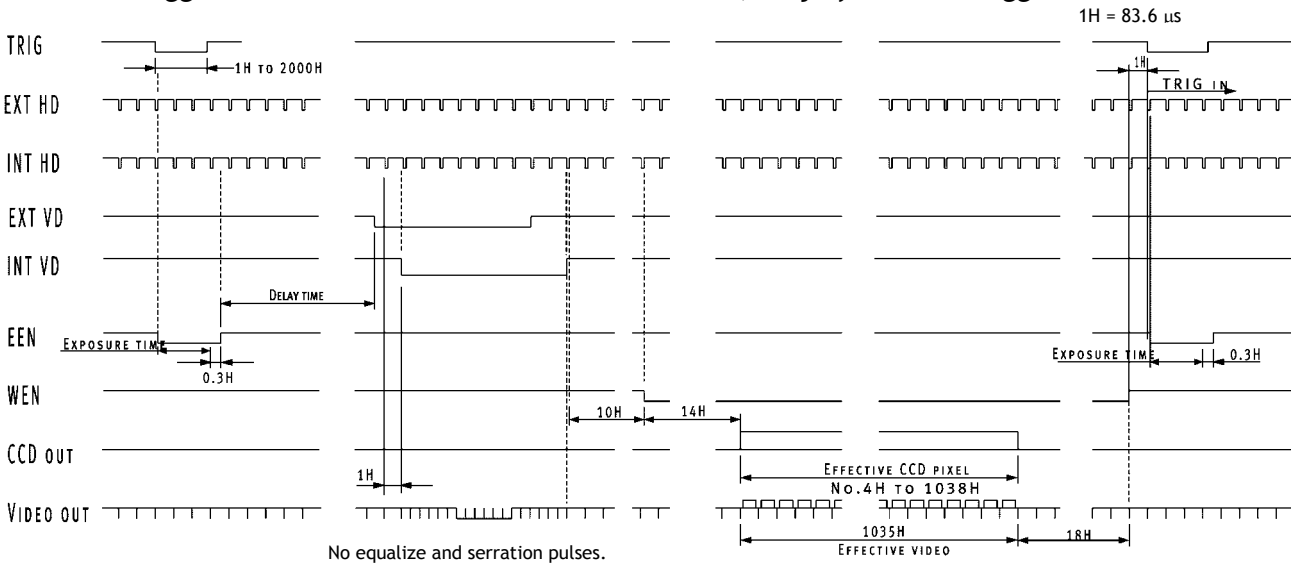

Table showing the figures for the different modes.

| Binning | A (CCD array line #) | B |
|---------|-------------------------|-------|
| Normal | 4 to 1038 | 1035H |
| H | 4 to 1038 | 1035H |
| V | 18 to 1019 | 501H |
| V+H | 18 to 1019 | 501H |

Fig. 22. Frame Delay read out mode

6.8. Long Time Exposure Mode

The exposure time is the interval between 2 external VD pulses sent to the VD input. The exposure starts after the input of a VD, and it ends after the next VD input, which again starts a new exposure. The interval between the external VD pulses (exposure time) can be from V to ∞. Thermal and dark current noise will increase by accumulation time, therefore the exposure time is not recommended to exceed 2 seconds (or 30 V periods). The external applied sync system should follow the camera scan system.

The long time exposure is a continuous process where each external VD pulse will synchronize the camera, stop an exposure, start a new exposure and read out the previous accumulated video signal.

A WEN pulse indicates that the resulting video is being read out.

To use this mode:

- Set function: Trigger mode "Long Time Exposure" TR = 4
Polarity and other functions
- Input: Ext. VD to pin 7 on 12-pin connector.
Ext. HD to pin 6 on 12-pin connector. (If used).

Important notes on using this mode.

- Depending of the temperature, it is not recommended to use integration time >2 sec.

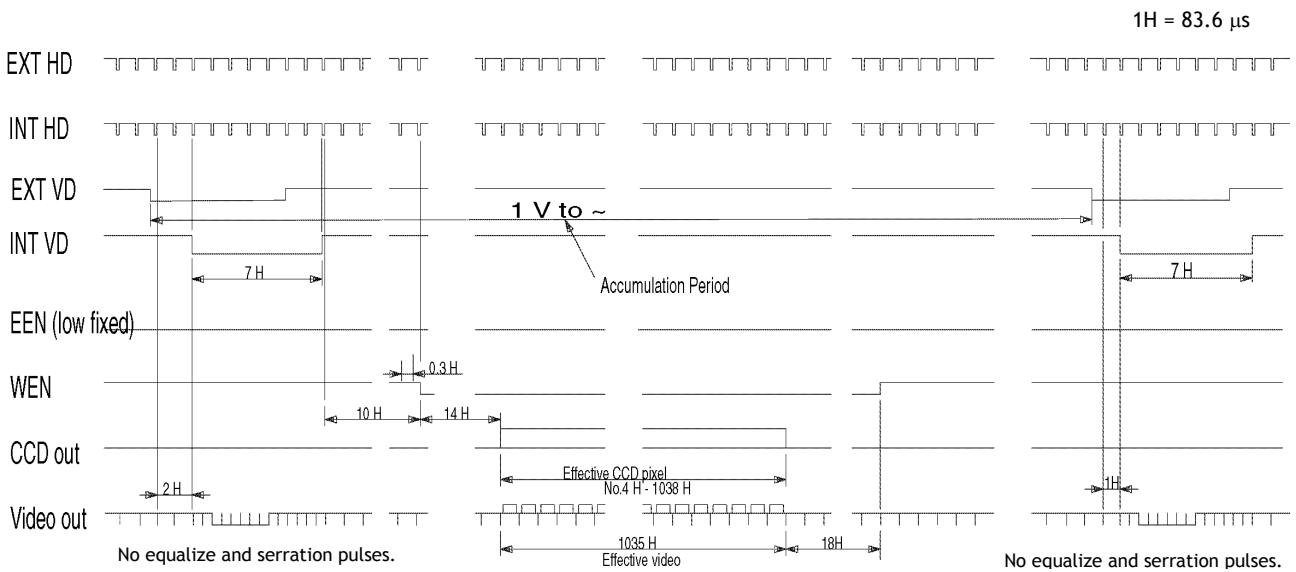

Notes: 1V is 1068H. The interval of EXT VD input is to be multiple number of V.

Fig. 23. Long time exposure

6.9. Start/Stop Mode

The exposure is controlled by the interval between the external trigger pulse and an external VD pulse. The exposure starts at the first HD pulse after the trigger leading edge, and it stops after the rising edge of the VD. An EEN pulse will indicate the active accumulation time, and a WEN pulse indicates that the resulting video is being read out.

The shortest exposure time in this mode is $>1.3H$.

The longest exposure time is $<2000 H$.

To use this mode:

- Set function: Trigger mode "Start/Stop Mode" TR = 5
 Polarity and other functions
- Input: Ext. trigger to pin 5 on 6-pin connector (or pin 11 on 12-pin con.).
 Ext. VD to pin 7 on 12-pin connector.
 Ext. HD to pin 6 on 12-pin connector. (If used).

Important notes on using this mode.

- The start of exposure will start synchronized to the internal H signal. The start may be shifted max 1H. To avoid this shift (1 H jitter), synchronize the camera to an external HD and make sure that the trigger pulse aligns to the HD as shown in fig. 17.
- The duration of the trigger should be $>1H$.
- A new trigger must not be applied before WEN is high.
- *In trigger modes there are no continuous VD out, only after each trigger input.*

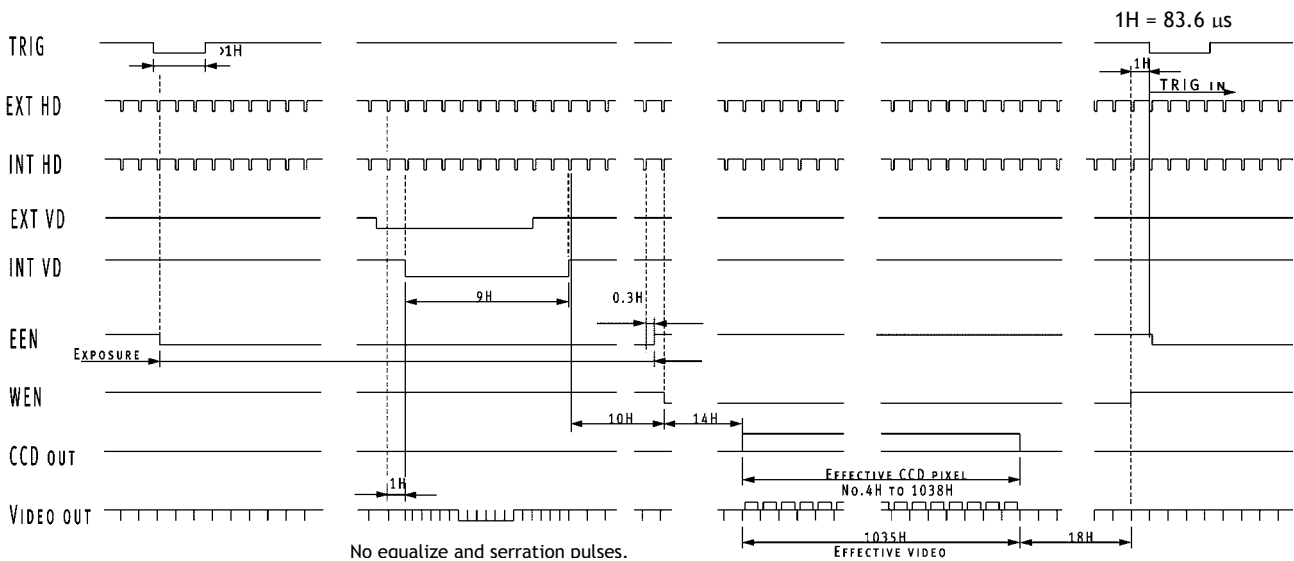

Fig. 24. Start/Stop mode

6.10. Smearless Mode

This mode will reduce the unwanted smear signal from a highlighted scene when a short exposure time is used. The trigger mode is like edge pre-select, but a dummy readout is performed before the active accumulation is started. It will remove the smear above the highlighted parts in the image, but there is still smear left below highlighted areas. The trigger leading edge will start the dummy readout. It takes 54 H before the exposure starts. The exposure stops and the resulting video signal is read out after the selected shutter time. It can be the 16 step normal or 1023 step programmable. SM=0 or SM=1. This mode will operate with full and partial scanning and with all binning modes. Partial scanning together with binning will work, but it is not described, and no timing diagrams will be documented. An EEN pulse will indicate the active accumulation time, and a WEN pulse indicates that the resulting video is being read out.

To use this mode:

Set function: Trigger mode "Smearless read out" TR = 6
 Shutter mode "Normal" or "Programmable" SM=0, SM=1
 "Shutter Speed" SH=0 through 9
 "Programmable exposure" PE=1 through 1023
 Polarity and other functions

Input: Ext. trigger to pin 5 on 6 pin connector (or pin 11 on 12-pin connector).
 Ext. HD to pin 6 on 12-pin connector. (If used).

Important notes on using this mode.

- The start of exposure will start synchronized to the internal H signal. The start may be shifted max 1H. To avoid this shift (1 H jitter), synchronize the camera to an external HD and make sure that the trigger pulse aligns to the HD as shown in fig. 17.
- The duration of the trigger should be >1H to <2000H.
- A new trigger must not be applied before WEN is high.
- *In trigger modes there are no continuous VD out, only after each trigger input.*

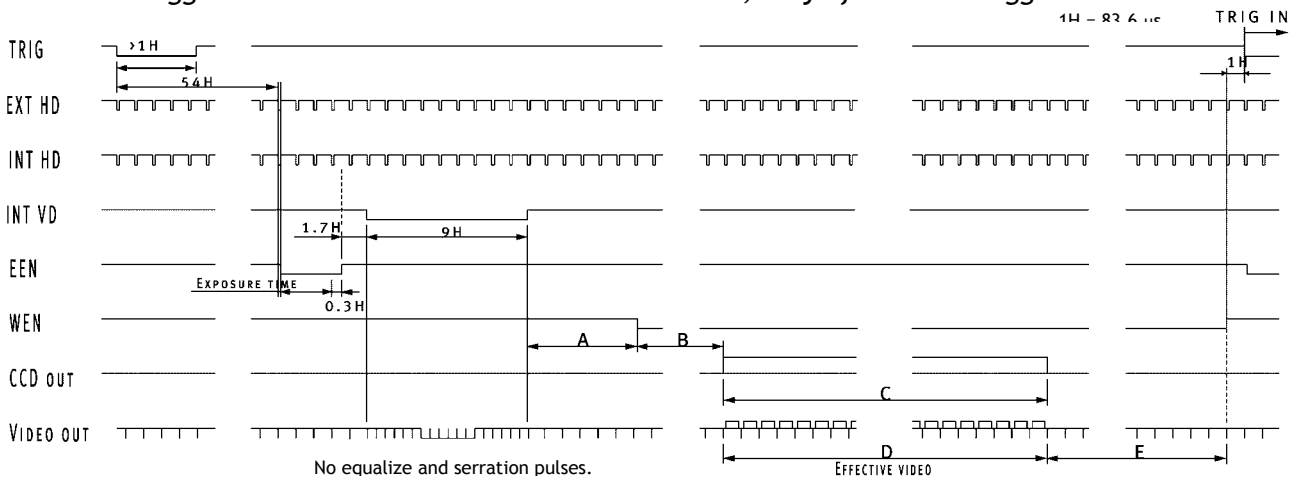

| Scan mode | A | B | C CCD array line # | D Effective video | E | Max frame rate fps | Remarks |
|-------------|-----|-----|-----------------------|----------------------|-----|-----------------------|---------|
| Full | 10H | 14H | 4 to 1038 | 1035H | 18H | 11 | |
| 1/2 Partial | 17H | 33H | 271 to 783 | 513H | 25H | 18 | |
| 1/3 Partial | 17H | 33H | 357 to 697 | 341H | 25H | 25 | |
| 1/6 Partial | 17H | 33H | 442 to 612 | 171H | 25H | 38 | |
| H binning | 10H | 14H | 4 to 1038 | 1035H | 18H | 11 | |
| V binning | 10H | 14H | 18 to 1019 | 501H | 18H | 20 | |
| V+H binning | 10H | 14H | 18 to 1019 | 501H | 18H | 20 | |

Fig. 25. Smearless Mode

6.11. Other Functions.

Gain and analogue settings.

!! Do not adjust these settings unless you have knowledge to video adjustments !!

The video gain can be set to **AGC** or **manual**. In AGC mode the video level is kept constant by the automatic gain control circuit within a 12 dB range. Normal 700 mVpp ±30 mV. The level can be adjusted with **AGC level**.

In manual gain mode, either the gain level or the rear potentiometer can adjust the level.

Setup level. This setting can adjust the setup level (or black level). Normal 20 mVpp ±2 mv.

White clip level. For adjusting the wanted white clip level. Normal 800 mVpp ±30 mv.

Gamma select. Gamma can be 1 (linear) or 0.45.

Sync signal on/off. Off will remove the composite sync signal from the video signal.

Pixel clock on/off. Set to on if the pixel clock is used. To avoid interference the pixel clock out should be off when not used.

EEN/WEN output. Will select EEN or WEN signal output on pin #6 on 6-pin connector.

Trigger polarity. Will invert the trigger-input signal.

WEN polarity. Will invert the WEN output signal.

7. Configuring the Camera

7.1. RS-232C control.

All configuration of the CV-A1-20 camera is done via the RS-232C port. The camera can be set up from a PC running terminal emulator software, or using JAI's camera control software.

Below is the description of the ASCII based short command protocol.

Communication setting.

| | | | | |
|------------------|----------|--------------------------------|-------|--|
| Baud Rate | 9600 bps | RS 232C cable CAMERA | 1 CD | 9 pin D-con PC COM PORT |
| Data Length | 8 bit | | 2 RXD | |
| Start Bit | 1 bit | | 3 TXD | |
| Stop Bit | 1 bit | | 5 GND | |
| Parity | None | | 7 RTS | |
| Xon/Xoff Control | None | | 8 CTS | |
| | | | 9 CI | |

Protocol.

Transmit setting to camera:

NN=[Parameter]<CR><LF> (NN is any kind of command. Capital or small letters.)

To have all communication visible on the emulator screen, start with:

EB=1<CR><LF>

The camera answers:

COMPLETE<CR><LF>

Transmit the following to have the actual parameter for a command:

NN?<CR><LF> (NN is any commands with parameters.)

The camera answers: **NN=[Parameter]**

Transmit the following to have the camera actual setting:

ST?<CR><LF>

The camera returns the actual parameter settings.

Transmit the following to have a command list:

HP?<CR><LF>

The camera returns a complete command list.

7.2. CV-A1-20 RS-232C command list.

| | Command Name | Format | Parameter | | Remarks |
|---|----------------------------------|---------------------|---|---|--|
| A - General settings and useful commands | | | | | |
| EB | Echo Back | EB=[Param.]<CR><LF> | 0=Echo off | 1=Echo on | Off at power up |
| ST | Camera Status request | ST?<CR><LF> | | | Actual setting |
| HP | Online Help request | HP?<CR><LF> | | | Command list |
| VN | Firmware version | VN?<CR><LF> | | | 3 letter version |
| ID | Camera ID request | ID?<CR><LF> | | | 10 characters *3) |
| MD | Model name request | MD?<CR><LF> | | | ≤10 characters *3) |
| UD | User ID | UD=[Param.]<CR><LF> | Save and load user text | | ≤16 characters *3) |
| B - Timing and shutter related commands | | | | | |
| SC | Scanning format | SC=[Param.]<CR><LF> | 0=full frame 2=1/3 partial | 1=1/2 partial 3=1/6 partial | |
| TR | Trigger mode | TR=[Param.]<CR><LF> | 0=normal 2=Pulse width 4=Long time 6=Smearless | 1=Edge 3=Frame delay 5=Start/stop | |
| SM | Shutter mode | SM=[Param.]<CR><LF> | 0=Normal | 1=Programmab. | |
| SH | Shutter speed | SH=[Param.]<CR><LF> | 0=Off 2=1/42 4=1/175 6=1/698 8=1/2794 10=1/14,000 12=1/56,000 14=1/112,000 | 1=1/21 3=1/70 5=1/349 7=1/1397 9=1/5587 11=1/28,000 13=1/84,000 15=1/140,000 | All16 step is valid in normal trigger mode. In all trigger modes shutter speeds higher than 9 will result in 1/8381 |
| PE | Programmable expos. | PE=[Param.]<CR><LF> | 0=1.3 H, 1=1.3H | 1023=1023.3 H | H= 83.6 μsec |
| BI | Binning | BI=[Param.]<CR><LF> | 0=off 2=horizontal | 1=vertical 3=hor. + ver. | *1) |
| HC | HD accumulation | HC=[Param.]<CR><LF> | 0=H synchron accumulation | 1=a-synchron accumulation | a-sync. only for TR=1 and TR=3 |
| C - Signals and polarity | | | | | |
| SO | Sync signal | SO=[Param.]<CR><LF> | 0=no sync | 1=sync on video | |
| PC | Pixel clock | PC=[Param.]<CR><LF> | 0=no clock out | 1=clock out | Should be off when not used |
| EW | EEN/WEN | EW=[Param.]<CR><LF> | 0= EEN out | 1=WEN out | Pin#6 on 6 pin |
| TP | Trigger polarity | TP=[Param.]<CR><LF> | 0= active low | 1= active high | *2) |
| WP | WEN polarity | WP=[Param.]<CR><LF> | 0= active low | 1= active high | |
| D - Gain and analogue signals setting | | | | | |
| AS | AGC Switch | AS=[Param.]<CR><LF> | 0=AGC off | 1=AGC on | 0= manual gain |
| AG | AGC Level | AG=[Param.]<CR><LF> | 0=low | 255=high | Range 0 to 255 |
| GA | Manual gain Level | GA=[Param.]<CR><LF> | 0=low | 255=high | Range 0 to 255 |
| RP | Rear Potentiometer | RP=[Param.]<CR><LF> | 0>manual gain | 1=rear potm. | |
| SU | Setup Level | SU=[Param.]<CR><LF> | 0=low | 255=high | Range 0 to 255 |
| WC | White clip Level | WC=[Param.]<CR><LF> | 0=low | 255=high | Range 0 to 255 |
| GS | Gamma Select | GS=[Param.]<CR><LF> | 0=gamma 1 | 1=gamma 0.45 | |
| E - Saving and loading data in EEPROM | | | | | |
| LD | Load settings from camera EEPROM | LD=[Param.]<CR><LF> | 0=Factory data 2=User 2 area | 1=User 1 area 3=User 3 area | Latest used data area becomes default at next power up |
| SA | Save settings to camera EEPROM | SA=[Param.]<CR><LF> | 1=User 1 area 3=User 3 area | 2=User 2 area | |
| EA | EEPROM area request | EA?<CR><LF> | | | Return latest used area |

*1) The internal pixel clock is not changed in H binning (BI=2 and BI=3). To keep the aspect ratio correct, divided the clock by 2 in the frame grabber.
 *2) If positive logic is used (TP=1), the first trigger pulse after power up will be ignored.
 *3) Functions implemented from s/no E121231.

7.3. Camera Control Tool for CV-A1-20

Camera Control Tool for CV-A1-20 is in principle the same as for CV-A1, only the shutter times are different. From www.jai.com CV-A1-20 Camera Control Tool for Windows 98/NT/2000 can be downloaded.

The control tool contents a camera control program and tools for making your own program. Below the different windows are shown.

Control Bar



Windows for all functions

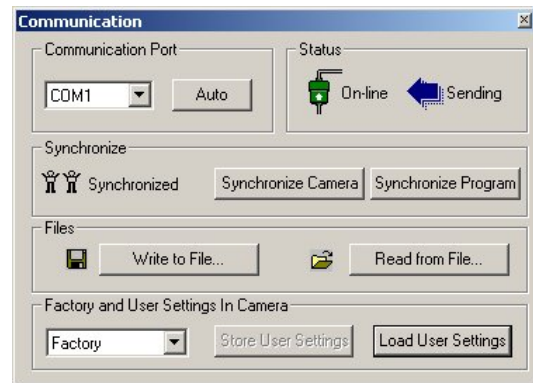
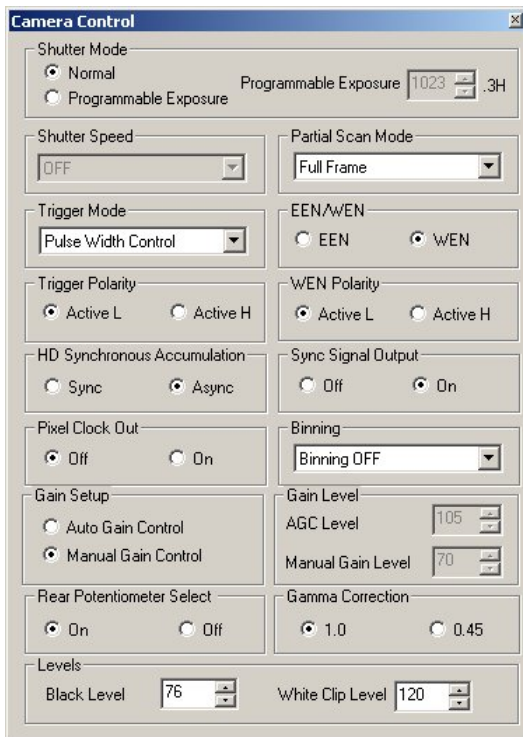

Fig. 26. Windows from Camera Tools.

For the integrator and experienced user, the Camera Control Tool is much more than a program with a window interface- It also provides an easy and efficient ActiveX interface built for MS Windows 98, ME, NT and 2000. The OCX interface has the ability to connect to the camera using the serial interface of the PC by reading and writing properties for the camera. This integration requires simple programming skills within Visual Basic, Visual C++ or similar languages in a Microsoft Windows environment.

7.4. Internal Switch and Jumper Settings

For VD and HD input/output and termination refer to "6.2. Input-output of HD/VD Signals."

For alternative connections of pin #10 and #11 on 12-pin connector, jumper JP1, JP2, JP3, JP4 and JP5 can be used. Refer "5.3. Input and Output Circuits."

Jumper setting for alternative pin configuration for M-series camera emulating is shown below.

| Pin # | Function | JP2 | JP3 | JP5 | JP1 | JP4 | Remarks |
|-------|-----------------|-------|-------|-------|-------|-------|--|
| 9 | PCLK out | Short | | | | | Factory default setting (EIA-J standard) |
| 9 | No connection | Open | | | | | |
| 10 | WEN out | | Open | Short | | | Factory default setting (EIA-J standard) |
| 10 | Ground | | Short | Open | | | |
| 11 | Ext. trigger in | | | | Open | Short | Factory default setting (EIA-J standard) |
| 11 | +12 Volt in/out | | | | Short | Open | Warning! +12 volt power out here. |

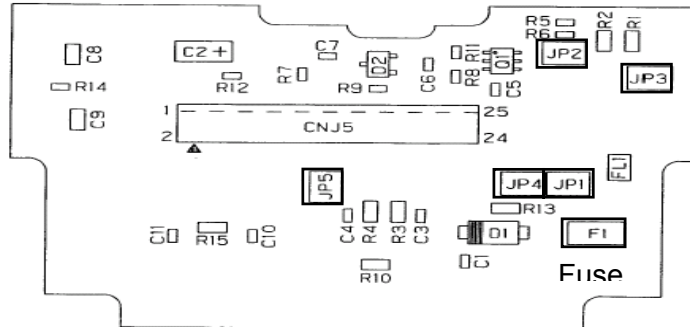

Fig. 27. Jumper positions.

8. External Appearance and Dimensions

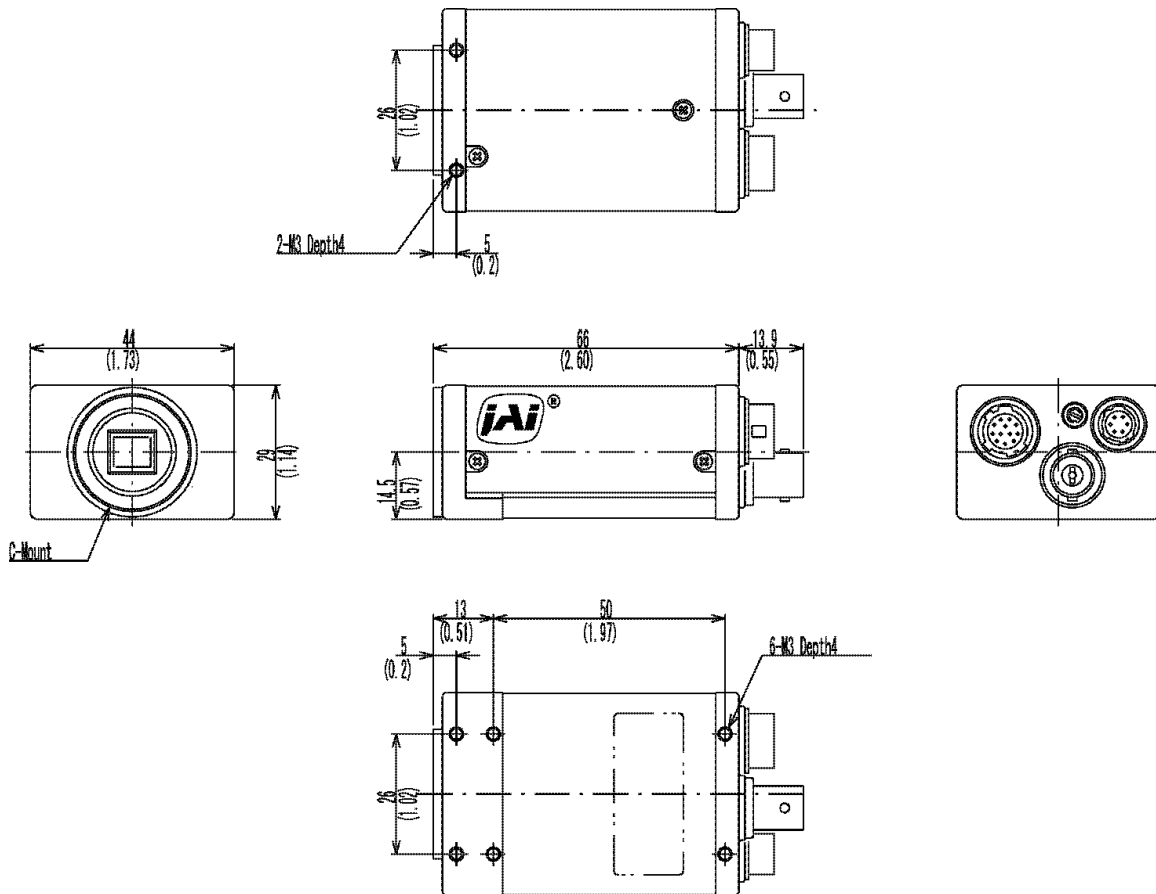
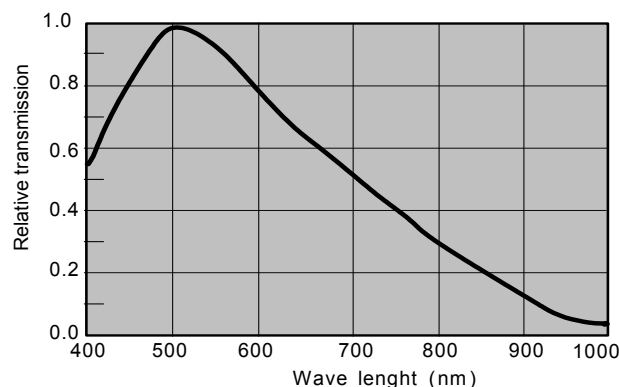

Fig. 28. Dimensions

9. Specifications

| Specifications | CV-A1-20 |
|--|---|
| Scanning system | Progressive 1068 lines 11.2 frames/sec. |
| Pixel clock | 20.00 MHz |
| Line frequency | 11.962 kHz (1672 pixel clock/line) |
| Frame rate for full frame | 11.2 frames/sec. (1068 lines/frame) |
| CCD sensor | 1/2" progressive monochrome IT CCD |
| Sensing area for video out | 6.42 (h) x 4.81 (v) mm |
| Effective pixels | 1392 (h) x 1040 (v) |
| Pixels in video output | 1380 (h) x 1035 (v) |
| Cell size | 4.65 (h) x 4.65 (v) μm |
| Resolution horizontal | 1000 TV lines |
| Sensitivity on sensor | 0.2 Lux, Max gain, 50% video |
| S/N ratio | >50 dB |
| Video output | Composite VS signal, 1 Vpp, 75 Ω Video signal 0.7 Vpp (selectable) |
| Gamma | 1.0 - 0.45 |
| Gain | Manual - Automatic |
| Gain range | Man. -3 to +12 dB. Aut. 0 to +12 dB |
| Synchronization | Int. X-tal. Ext. HD/VD or random trigger |
| HD sync. input/output | 4 V \pm 2 V, 75 Ω |
| Trigger input | 4 V \pm 2 V, 1k Ω input impedance |
| WEN output (write enable) | 4 V \pm 2 V, 75 Ω |
| EEN output (exposure enable) | 4 V \pm 2 V, 75 Ω |
| Pixel clock output | 4 V \pm 2 V, 75 Ω |
| Read out modes for full frame | Full, 2:1 H binning, 2:1 V binning, H+V binning |
| Read out partial scan vertical | Full, 1/2, 1/3, 1/6 |
| Trigger | Continuous, Edge pre-select, Pulse width control, frame delay |
| Accumulation by trigger | H synchronized/ (H non synchronized. In PWC and frame delay only) |
| Shutter speed. Fixed (Full frame only) | 1/11, 1/21, 1/42, 1/70, 1/175, 1/349, 1/698, 1/1400, 1/2800, 1/5587, 1/14,000, 1/28,000, 1/56,000, 1/84,000, 1/112,000, 1/140,000 second |
| Shutter speed in trigger modes | Max. 1/5587 second. (1/8381 for settings >1/5587) |
| Programmable exposure | 1.3 H to 1023.3 H in 1 H step |
| Pulse width control | 1.3 H to 2000 H |
| Long time exposure | <2 sec. (Interval between ext. VD) |
| Start/stop exposure | 1.3 H to - 2000 H (Time from trigger to ext. VD) |
| Frame delay readout PWC | 1.3 H to 2000 H |
| Delay in frame delay readout mode | < 2 seconds (Time from PWC trigger input to ext. VD input.) |
| Smearless readout | For edge pre-select mode only |
| Functions controlled by internal DIP switches | VD input/output, HD input/output HD, VD 75 Ω termination on/off |
| Functions controlled by RS 232C short commands | Shutter speed, shutter mode, Trigger mode, Readout mode, polarity, Sync. on/off, Programmable exposure, Gain levels, Gamma and RS 232C Commands |
| Communication Baud rate | 9600 bps |
| Operating temperature | -5°C to +45°C |
| Humidity | 20 - 80% non-condensing |
| Storage temp./humidity | -30°C to +60°C/20% - 90 % non-condensing |
| Power | 12V DC \pm 10%. 1.8 W |
| Lens mount | C-mount |
| Dimensions | 29 x 44 x 66 mm (HxWxD) |
| Weight | 150g |

Spectral Sensitivity



10. Appendix

10.1. Precautions

Personnel not trained in dealing with similar electronic devices should not service this camera.

The camera contains components sensitive to electrostatic discharge. The handling of these devices should follow the requirements of electrostatic sensitive components.

Do not attempt to disassemble this camera.

Do not expose this camera to rain or moisture.

Do not face this camera towards the sun, extreme bright light or light reflecting objects. When this camera is not in use, put the supplied lens cap on the lens mount.

Handle this camera with the maximum care.

Operate this camera only from the type of power source indicated on the camera.

Power off the camera during any modification such as changes of jumper and switch setting.

10.2. Typical CCD Characteristics

The following effects may be observed on the video monitor screen. They do not indicate any fault of the CCD camera, but do associate with typical CCD characteristics.

V. Smear

Due to an excessive bright object such as electric lighting, sun or strong reflection, vertical smear may be visible on the video monitor screen. This phenomenon is related to the characteristics of the Interline Transfer System employed in the CCD.

V. Aliasing

When the CCD camera captures stripes, straight lines or similar sharp patterns, jagged image on the monitor may appear.

Blemishes

Some pixel defects can occur, but this does not have an effect on the practical operation.

Patterned Noise

When the CCD camera captures a dark object at high temperature or is used for long time integration, fixed pattern noise (shown as white dots) may appear on the video monitor screen.

11. Users Record

Camera type: CV-A1-20
Revision: (Revision B)
Serial No.

Users Mode Settings

Users Modifications



DECLARATION OF CONFORMITY
AS DEFINED BY THE COUNCIL DIRECTIVE
89/336/EEC
EMC (ELECTROMAGNETIC COMPABILITY)
WE HEREWITH DECLARE THAT THIS PRODUCT
COMPLIES WITH THE FOWLING PROVISIONS APPLYING TO IT.
EN-50081-1
EN-50082-1

Company and product names mentioned in this manual are trademarks or registered trademarks of their respective owners.
JAI A-S cannot be held responsible for any technical or typographical errors and reserves the right to make changes to products and documentation without prior notification.

JAI A-S, Denmark
Phone +45 4457 8888
Fax +45 4491 8880
www.jai.com

JAI UK Ltd., England
Phone +44 1895 821 481
Fax +44 1895 824 433
www.jai.com

JAI Corporation, Japan
Phone +81 45 440 0154
Fax +81 45 440 0166
www.jai-corp.co.jp

JAI PULNiX Inc., USA
Phone (Toll-Free) +1 877 472 5909
Phone +1 408 747 0300
www.jaipulnix.com



THE MECHADEMIC COMPANY

Free Manuals Download Website

<http://myh66.com>

<http://usermanuals.us>

<http://www.somanuals.com>

<http://www.4manuals.cc>

<http://www.manual-lib.com>

<http://www.404manual.com>

<http://www.luxmanual.com>

<http://aubethermostatmanual.com>

Golf course search by state

<http://golfingnear.com>

Email search by domain

<http://emailbydomain.com>

Auto manuals search

<http://auto.somanuals.com>

TV manuals search

<http://tv.somanuals.com>