



*3CCD High Speed Color
Line Scan Camera*

CV-L105

Operation Manual

*Camera: Revision A
Manual: Version 1.1*

Table of Contents

1. General 2

2. Standard Composition 2

3. Main Features 2

4. Locations and Functions 2

5. Pin Assignment..... 3

 5.1. 68-pin Digital interface connector 3

 5.2. 6-pin Hirose connector (Power) 4

 5.3. 9-pin DSUB connector (RS-232C)..... 4

 5.4. Input and Output Circuits..... 5

 5.4.1. Video output..... 5

 5.4.2. Trigger input..... 6

 5.4.3. Binning select input 6

 5.4.4. Pixel rate select input 6

 5.4.5. RS-232C on/off (enable/disable) 6

6. Functions and Operations 7

 6.1. Principle of operation 7

 6.2. Trigger modes 9

 6.2.1. Internal Trigger. Scan mode. 10

 6.2.2. Internal Trigger. Shutter mode. 11

 6.2.3. External Trigger. Scan mode. 12

 6.2.4. External Trigger. Shutter mode. 13

 6.3. Other functions..... 14

 6.3.1. Binnig 14

 6.3.2. Pixel rate..... 14

 6.3.3. RS-232C on/off 14

 6.3.4. Offset and Gain 14

 6.3.5. LED on rear 14

7. Configuring the Camera..... 15

 7.1. RS-232C control. 15

 7.1.1. Clock Select..... 16

 7.1.2. Binning..... 16

 7.1.3. Trigger Mode..... 16

 7.1.4. Shutter/Scan Mode 16

 7.1.5. Shutter/Scan Time..... 16

 7.1.6. Gain and offset adjustment 17

 7.1.7. Communication and files 17

 7.2. Configuration via I/F connector and jumpers 18

 7.3. Potentiometers and jumpers placing 18

8. External Appearance and Dimensions 19

9. Specifications 20

 9.1. Specifications table..... 20

 9.2. Spectral Sensitivity 20

10. Users Record..... 21

1. General

The CV-L105 is a high-speed 3CCD color line scan camera with 2048 pixels resolution. It features digital LVDS RGB output with 30 MHz pixel rate, allowing line rate up to 14285 lines/second. An exposure control function facilitates constant exposure time, independent of the scan rate. In combining the latest dichroic prism and line sensor technology, the CV-L105 provides excellent color reproduction with high linearity.

The latest version of this manual can be downloaded from: www.jai.com

The latest version of Camera Control Software Tool for CV-L105 can be downloaded from www.jai.com

For camera revision history, please contact your local JAI distributor.

2. Standard Composition

The standard camera composition consists of the camera main body.

3. Main Features

- 3CCD prism based architecture
- 3 x 2048 pixels, 14 μm x 14 μm
- User selectable pixel rate, 15 or 30 MHz
- Internal or external triggered scanning
- Pulse interval and pulse width exposure control
- Scanning up to 7172 lines/sec at 15 MHz, and up to 14285 lines/sec at 30 MHz
- Binning function for higher sensitivity
- EIA-644 LVDS digital output with 3 x 8 bit
- Optimized for Nikon F-mount SLR lenses
- RS-232C control

4. Locations and Functions

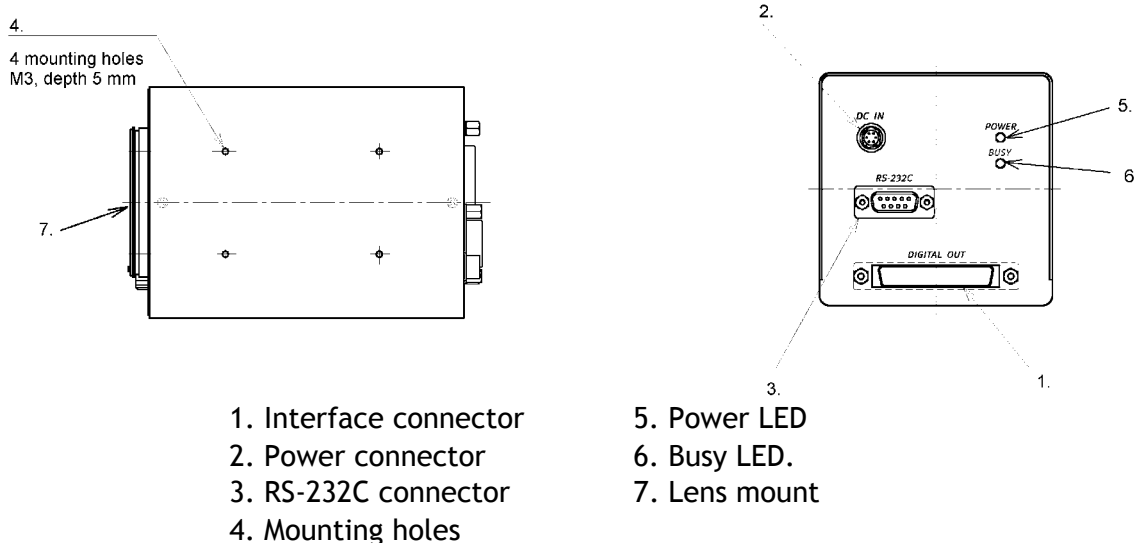

Fig. 1. Locations

5. Pin Assignment

5.1. 68-pin Digital interface connector

(Digital video, control signals, trigger input)

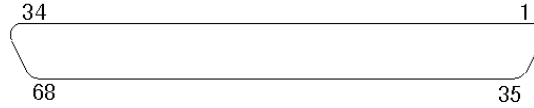

Fig. 2. 68-pin digital interface. (Seen from camera rear.)

Pin number	Signal	Remarks	Pin number	Signal	Remarks
1	GND		35	GND	
2	+RD7 out	Red Data out. LVDS	36	-RD7 out	Red Data out. LVDS
3	+RD6 out		37	-RD6 out	
4	+RD5 out		38	-RD5 out	
5	+RD4 out		39	-RD4 out	
6	+RD3 out		40	-RD3 out	
7	+RD2 out		41	-RD2 out	
8	+RD1 out		42	-RD1 out	
9	+RD0 out		43	-RD0 out	
10	BIN in		Control inp. TTL *)	44	
11	+GD7 out	Green Data out. LVDS	45	-GD7 out	Green Data out. LVDS
12	+GD6 out		46	-GD6 out	
13	+GD5 out		47	-GD5 out	
14	+GD4 out		48	-GD4 out	
15	+GD3 out		49	-GD3 out	
16	+GD2 out		50	-GD2 out	
17	+GD1 out		51	-GD1 out	
18	+GD0 out		52	-GD0 out	
19	+EXT TRIG in		LVDS in	53	
20	+BD7 out	Blue Data out. LVDS	54	-BD7 out	Blue Data out. LVDS
21	+BD6 out		55	-BD6 out	
22	+BD5 out		56	-BD5 out	
23	+BD4 out		57	-BD4 out	
24	+BD3 out		58	-BD3 out	
25	+BD2 out		59	-BD2 out	
26	+BD1 out		60	-BD1 out	
27	+BD0 out		61	-BD0 out	
28	NC			62	
29	GND		63	GND	
30	RS-232 on/off	Control inp. TTL *)	64	NC	
31	PIXEL RATE in	Control inp. TTL *)	65	NC	
32	+STROBE out	LVDS out	66	-STROBE out	LVDS out
33	+LEN out	LVDS out	67	-LEN out	LVDS out
34	GND		68	GND	

*) The control inputs are TTL and it has 4.7 kΩ pull up to +5V.

The camera connector part number is Hirose DX10A-68S.

The connector to use on the cable side is Hirose DX31A-68P with back shell DX68-CV1

5.2. 6-pin Hirose connector (Power)

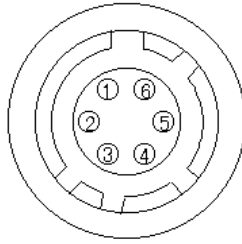

Fig. 3. 6-pin Hirose. (Seen from camera rear.)

Pin no.	Signal	Remarks
1	NC	
2	NC	
3	GND	Power GND
4	GND	Power GND
5	NC	
6	+12V DC in	+ Power in

The camera connector part number is Hirose H10A-7R-6P. (Male).
 The mating connector to use on the cable side is Hirose HR10A-7P-6S

5.3. 9-pin DSUB connector (RS-232C)

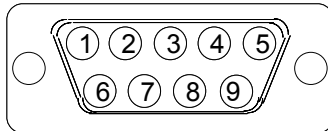

Fig. 4. 9-pin DSUB for RS-232C. (Seen from camera rear.)

Pin no.	Signal	Remarks
1	NC	
2	TXD	To PC
3	RXD	From PC
4	NC	
5	GND	
6	NC	
7	NC	
8	NC	
9	NC	

The connector on the camera is a 9-pin DSUB male connector. The cable to the PC is a straight through RS-232C cable.

5.4. Input and Output Circuits

Video outputs, timing outputs, trigger input and control inputs are found on the 68 pin LVDS connector.

5.4.1. Video output

The digital EIA-644 LVDS output is constructed as follows:

Red channel video output

+RD0 to +RD7 Bits 0 to 7 positive side of the differential signal
-RD0 to -RD7 Bits 0 to 7 negative side of the differential signal

Green channel video output

+GD0 to +GD7 Bits 0 to 7 positive side of the differential signal
-GD0 to -GD7 Bits 0 to 7 negative side of the differential signal

Blue channel video output

+BD0 to +BD7 Bits 0 to 7 positive side of the differential signal
-BD0 to -BD7 Bits 0 to 7 negative side of the differential signal

Bit 0 is LSB. Bit 7 is MSB.

STROBE This signal is used to latch the digital video into the frame grabber.

LEN Line enable, this signal is high during the read-out of the valid digital video.

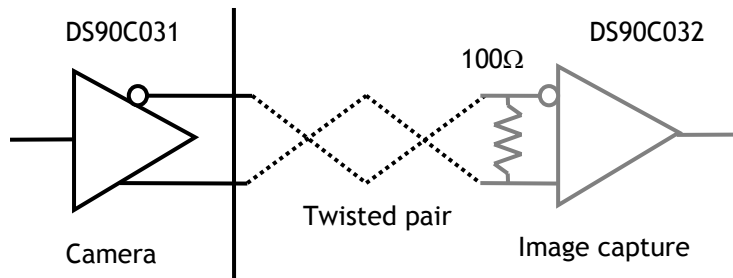

Fig. 5. Output driver circuit for Video, STROBE and LEN signals

5.4.2. Trigger input

The camera is triggered by an EIA-644 LVDS input signal pair. (+EXT TRIG in/ -EXT TRIG in (on pin #19 and pin #53)).

Depending on the configuration of the camera, this input can provide operation in 4 modes:

- Internal Trigger. Scan mode.*
- Internal Trigger. Shutter mode.*
- External Trigger. Scan mode.*
- External Trigger. Shutter mode.*

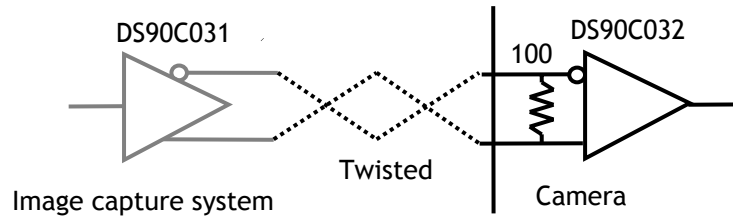

Fig. 6. Input receiver circuit for EXT TRIG

5.4.3. Binning select input

This input on pin #10 (internal jumper JP1=short, JP2=open, JP4=open and RS232C disabled) allows external equipment, such as a frame grabber, PLD or similar to enable the horizontal binning function. The input circuit accepts TTL levels. It has 4.7 kΩ pull up to +5V. Open for no binning.

For configuration please refer to 7.2 and 7.3.

5.4.4. Pixel rate select input

This input on pin #31 (internal jumper JP 5 open and RS232C disabled) allows external equipment, such as a frame grabber, PLD or similar to select the pixel rate. The input circuit accepts TTL levels. It has 4.7 kΩ pull up to +5V. Open for 30 MHz.

For configuration please refer to 7.2 and 7.3.

5.4.5. RS-232C on/off (enable/disable)

This input on pin #30 (internal jumper JP3=short, JP4=open. (Factory settings, JP3=open, JP4=short.)) allows the RS-232C function to be disabled. It is useful when the camera is operated in an environment with RFI fields are present. The input circuit accepts TTL levels. It has 4.7 kΩ pull up to +5V. Open for RS232C enabled.

For configuration please refer to 7.2 and 7.3.

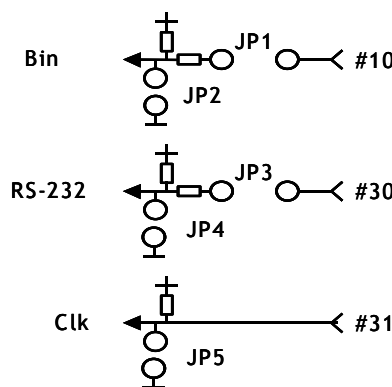

Fig. 7. Control input principle

6. Functions and Operations

6.1. Principle of operation

A line scan camera works according to the same principle as a fax machine, also sometimes referred to as a "push broom" operation.

It captures a single line at a time (horizontal), and requires either the object or the camera to be moving to create the vertical direction of the image.

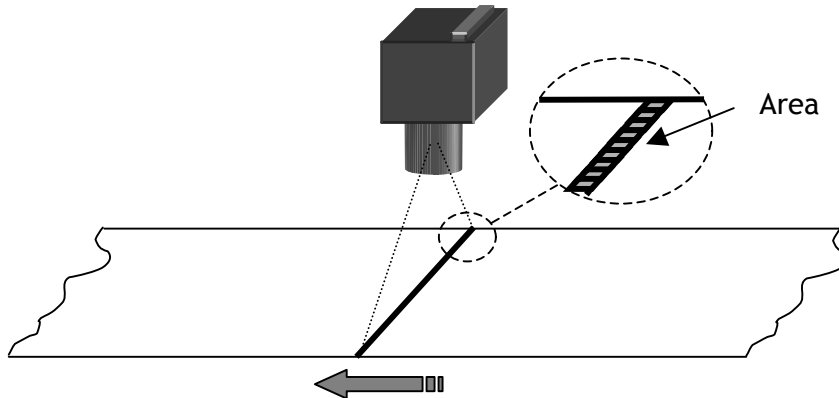

Fig. 8. The principle of line scan.

A 3CCD line scan camera follows the exact same principle, with the added complexity of three CCD sensors mounted on a dichroic prism. The three CCD sensors are aligned in such a way, that they all view the same part of the object. This is referred to as co-site sampling. Figure 4 shows the construction of the prism, and how the CCDs are aligned.

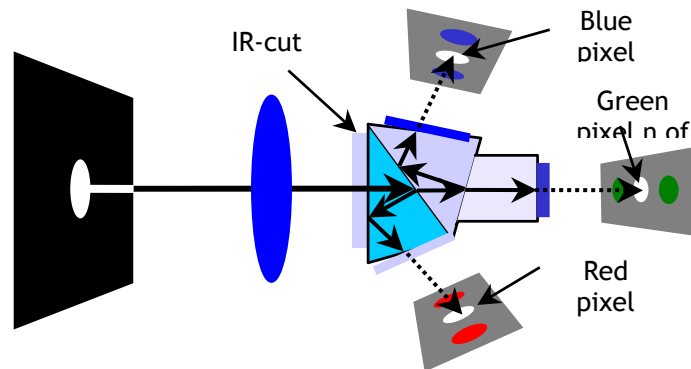

Fig. 9. 3 CCD prism construction.

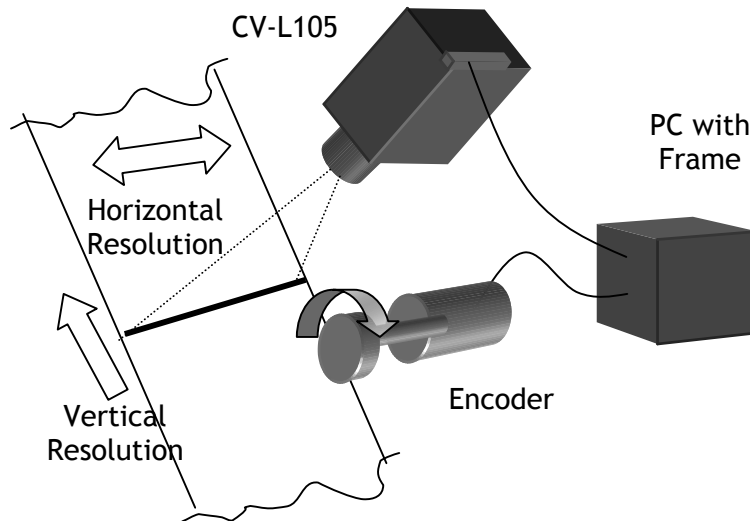

Fig. 10. Specifying an encoder.

Example of a camera set-up, with an encoder.

When using a line scan camera together with an encoder, it is crucial to calculate the required specifications of the encoder in order to maintain the same aspect ratio in both vertical and horizontal resolution.

The horizontal resolution is given by the number of pixels in the 3CCD camera.
The vertical resolution is given by the pulses generated by the encoder.

Example:

The width of the object to be scanned is 1000 mm.

This means that each pixel "projected" on the object represents a square of 0.488mm.

In order to maintain the same vertical resolution, the encoder needs to generate 2048 pulses, for a travel of 1000 mm.

With a max line frequency at 14.285 lines/sec. the vertical scanned length is
 $0.488 \text{ mm} \times 14285 = 6971 \text{ mm/sec.}$

6.2. Trigger modes

Internal Trigger. Scan mode.

The camera will operate continuously with its internal trigger.

The exposure is equal to the scanning time set by the SCAN parameter via RS-232C only. SHUTTER parameter has no meaning here. SCAN value 150 μ s through 32.5 ms.

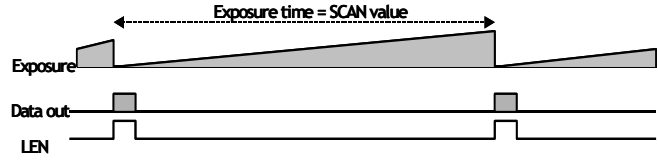

Internal Trigger. Shutter mode.

The camera will operate continuously with its internal trigger.

The scanning time is set by the SCAN parameter via RS-232C only.

The exposure is set by the SHUTTER parameter via RS-232C only.

SCAN value 150 μ s through 32.5 ms. SHUTTER value 1 μ s through 32.35 ms.

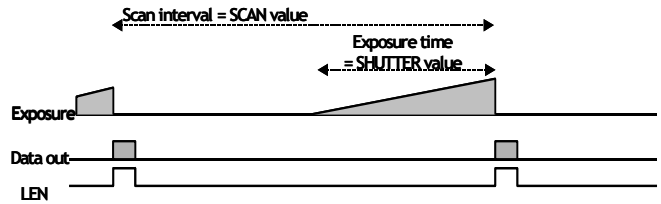

External Trigger. Scan mode.

For every EXT TRIG input the ongoing integration period is terminated and charge is read out. At the same time it starts a new cycle.

The exposure time is therefore dependant of the line rate.

SHUTTER and SCAN parameters has no meaning here.

Trigger pulse width (high period) >4 clk. *)

Trigger interval >2120 clk to ∞

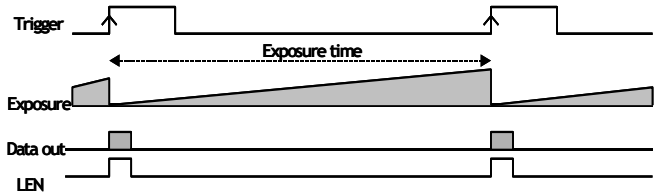

External Trigger. Shutter mode.

The exposure time is governed by the low period of the EXT TRIG signal. Exposure starts at the falling edge of the EXT TRIG signal and ends with the rising edge. The integration time is independent of the line rate.

SHUTTER and SCAN parameters has no meaning here.

Trigger pulse width (high period) >4 clk. *)

Exposure time (low period) >2102 clk to ∞

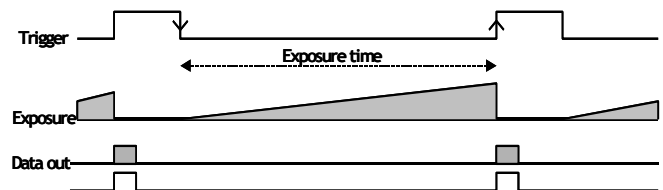

*) 1 clk is 33.3 ns for 30 MHz clock

1 clk is 66.6 ns for 15 MHz clock

Fig. 11. Internal and external trigger modes.

6.2.1. Internal Trigger. Scan mode.

In this mode, the camera does not require an EXT TRIG signal to be issued to the camera. The line rate (scan rate) is generated inside the camera. The camera will operate continuously with its internal trigger.

The exposure time is equal to the scanning time set by the SCAN parameter via RS-232C.

The permitted range for the scan rate is 151 μ s to 32.5 ms (corresponds to 6.6 kHz to 30 Hz).

SHUTTER parameter has no function here.

To use this mode:

Set function:	Trigger	Internal
	Mode	SCAN
	SHUTTER value	No function
	SCAN value	151 μ s through 32.5 ms
	Clock, Binning and other functions	

Input:

Important notes on using this mode:

- It is only recommended to use this mode when there is not change of speed in the object being scanned. If the speed of the object changes, the aspect ratio in the vertical (scanning) direction will change.
-

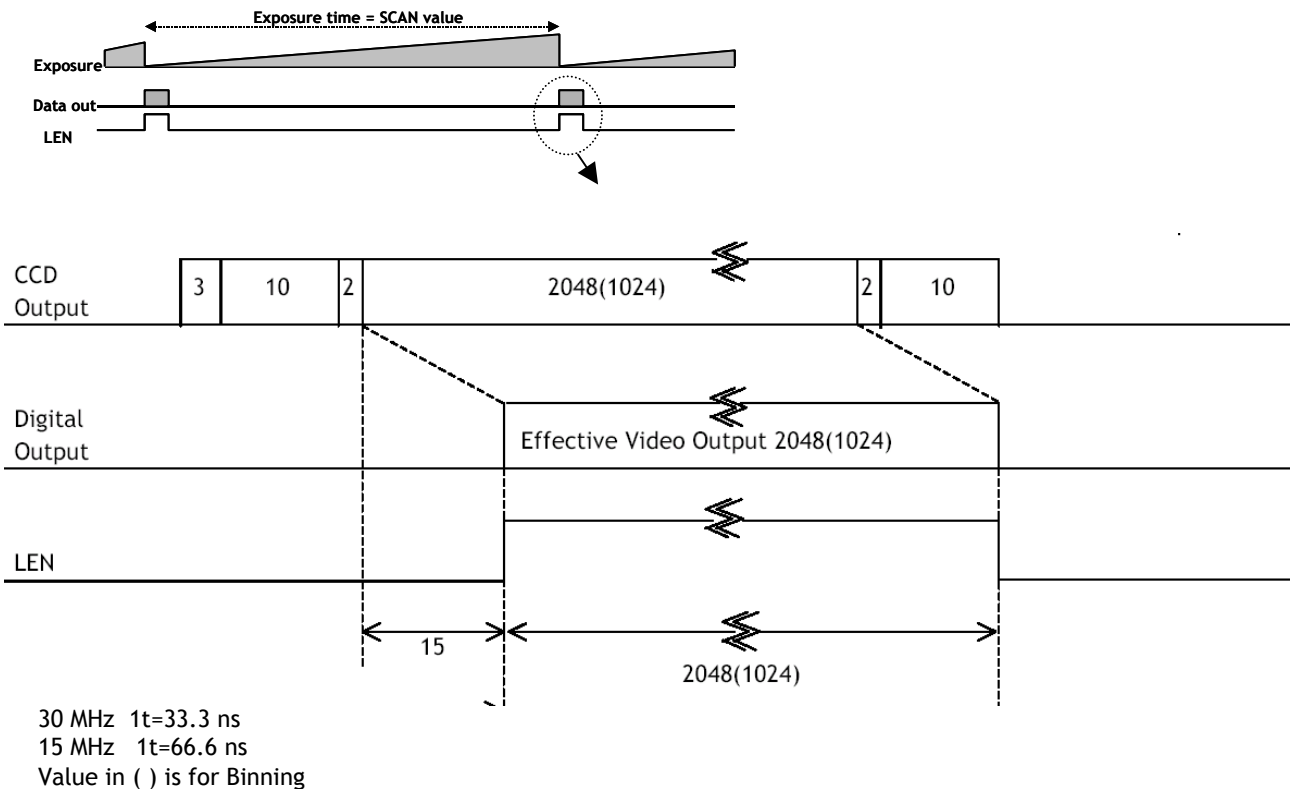

Fig. 12. Timing for internal scan mode

6.2.2. Internal Trigger. Shutter mode.

In this mode, the camera does not require an EXT TRIG signal to be issued to the camera. The line rate (scan rate) is generated inside the camera. The camera will operate continuously with its internal trigger.

The scanning interval is equal to the time set by the SCAN parameter.

The exposure time is equal to the Shutter time set by the SHUTTER parameter via RS-232C.

The permitted range for the scan rate is 151 μ s to 32.5 ms (corresponds to 6.6 kHz to 30 Hz).

The permitted range for the exposure time, SHUT value, is 1 μ s up to (SCAN time - 150 μ s). (Always less than SCAN.)

To use this mode:

Set function:	Trigger Mode	Internal SCAN
	SHUTTER value	1 μ s up to 32.35 ms
	SCAN value	151 μ s through 32.5 ms
	Clock, Binning and other functions	
Input:	Ext. trigger through the LVDS connector	

Important notes on using this mode:

- It is only recommended to use this mode when there is not change of speed in the object being scanned. If the speed of the object changes, the aspect ratio in the vertical (scanning) direction will change.

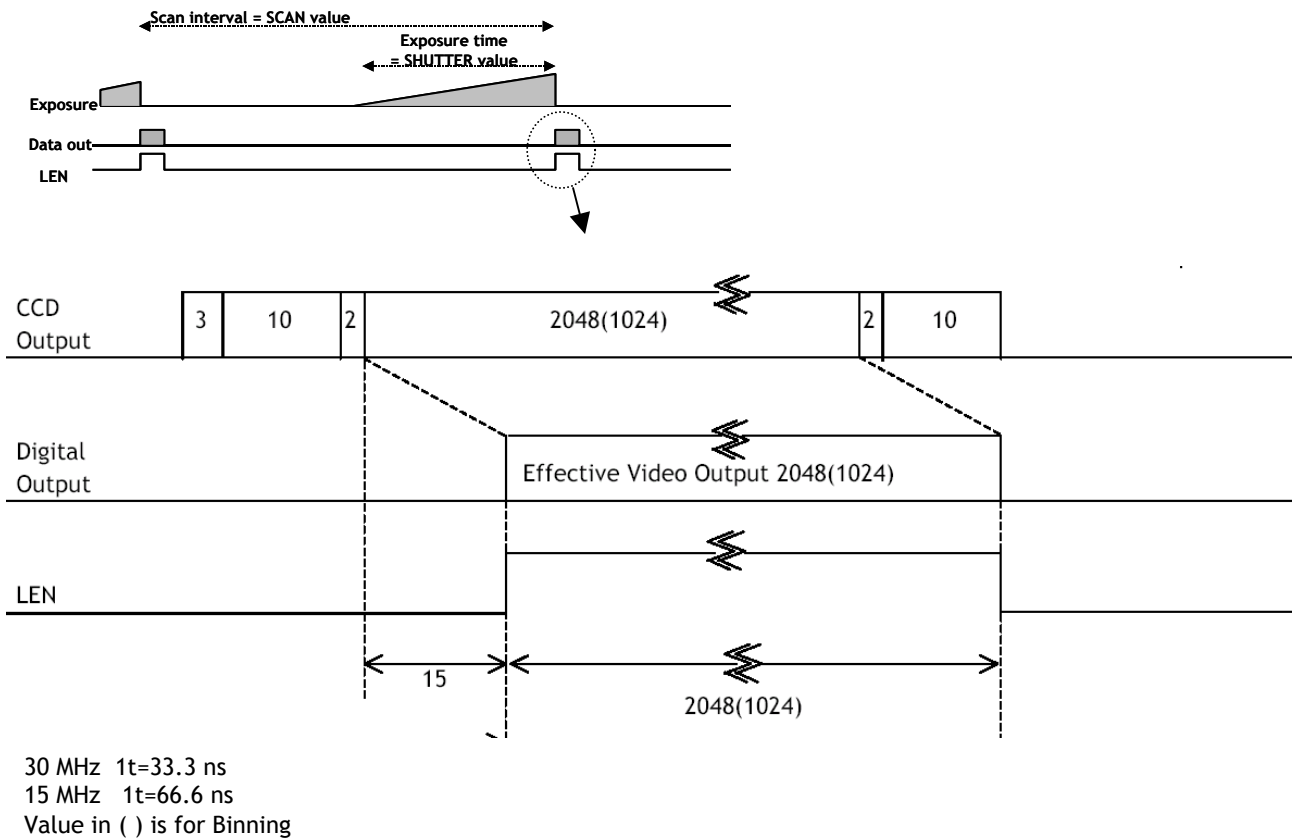

Fig. 13. Timing for internal shutter mode

6.2.3. External Trigger. Scan mode.

In this mode, the camera requires an EXT TRIG signal to be issued to the camera. The trigger signal is typical taken from an encoder. The exposure time is equal to the trigger interval. On the EXT TRIG input positive going edge the ongoing integration period is terminated and charge is read out. At the same time it starts a new cycle. The exposure time is therefore dependant of the line rate.

SHUTTER and SCAN parameters has no function here.

The permitted range for the trigger interval is >2120 clk to ∞.

Max scan rate is 14285 lines per second.

Trigger width should be >4 clk.

To use this mode:

Set function:	Trigger Mode	External SCAN
	SHUTTER value	No function
	SCAN value	No function
	Clock, Binning and other functions	
Input:	Ext. trigger through the LVDS connector	

Important notes on using this mode:

- It is only recommended to use this mode when there is not change of speed in the object being scanned. If the speed of the object changes, the exposure time change.
- Do not apply a new trigger before the previous result has been read out. >2120 clk.

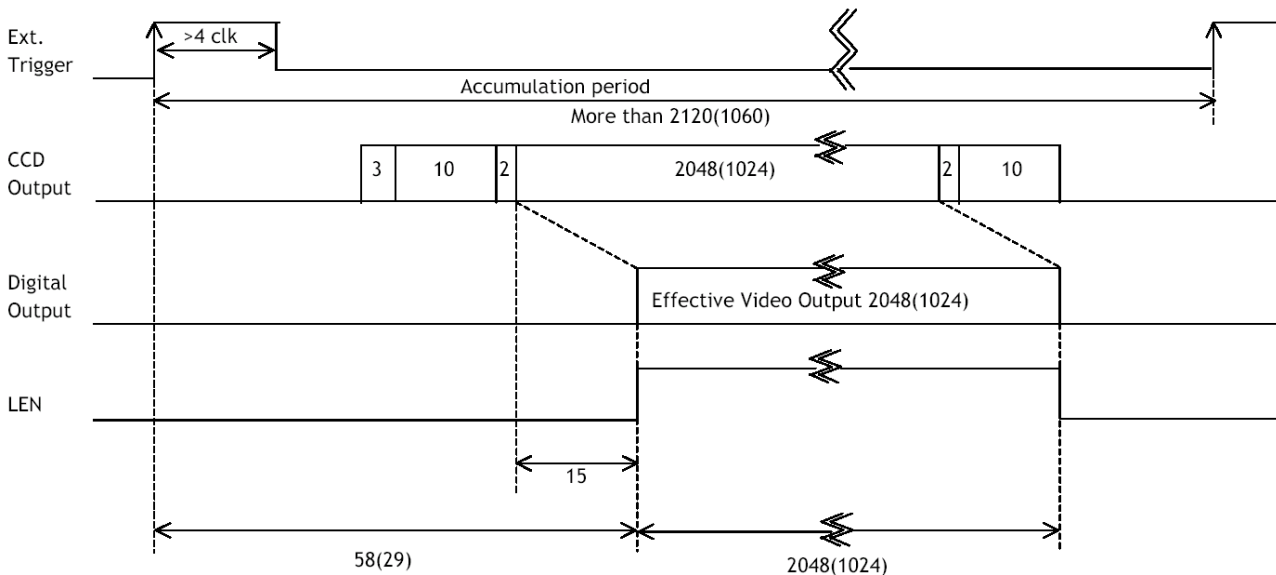

30 MHz 1t=33.3 ns
 15 MHz 1t=66.6 ns
 Value in () is for Binning

Fig. 14. Timing for external trigger scan mode

6.2.4. External Trigger. Shutter mode.

In this mode, the camera requires an EXT TRIG signal to be issued to the camera. The trigger signal is typically taken from an encoder. The scanning time is equal to the trigger interval. The exposure time is equal to the trigger low period (pulse width). For every EXT TRIG input negative going edge an integration period starts. It is terminated and charge is read out on the trigger positive going edge. The exposure time is therefore independent of the line rate. SHUTTER and SCAN parameters have no function here.

The permitted range for the trigger interval is >2120 clk to ∞.
 Max scan rate is 14285 lines per second.

To use this mode:

Set function:	Trigger Mode	External SHUTTER
	SHUTTER value	No function
	SCAN value	No function
	Clock, Binning and other functions	
Input:	Ext. trigger through the LVDS connector	

Important notes on using this mode:

- It is only recommended to use this mode when there is not change of speed in the object being scanned. If the speed of the object changes, the exposure time change.
- Do not apply a new trigger before the previous result has been read out. >2120 clk.

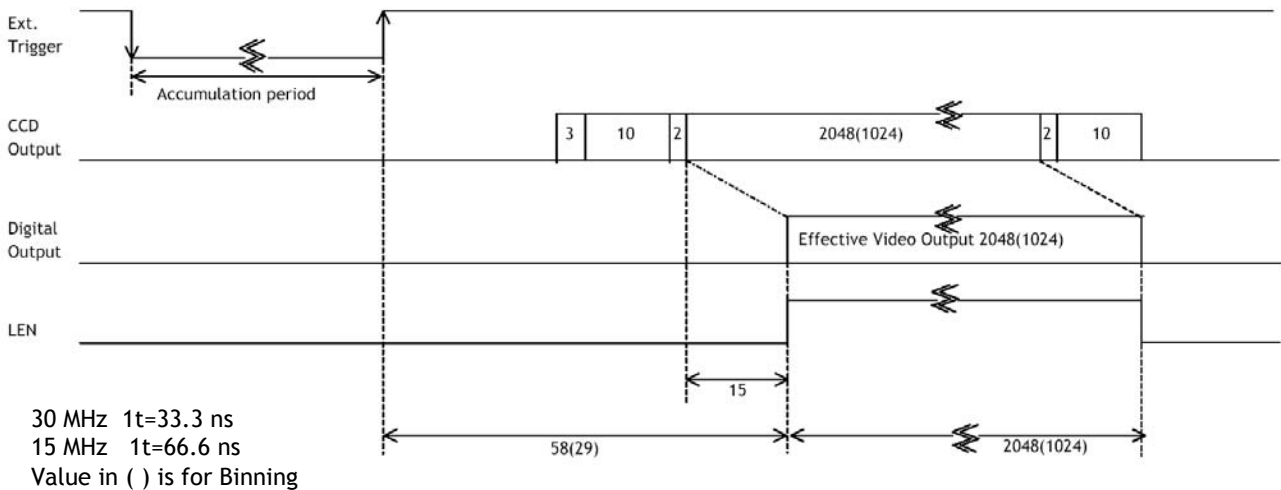

Fig. 15. Timing for external trigger shutter mode

6.3. Other functions

6.3.1. Binnig

Binning is a function where the signal from two neighbour pixels are added and read out as a single pixel. The sensitivity will be double, but the resolution will be the half. The binning function has no influence on the internal scan rate and shutter setting.

The function can be selected by RS-232C, internal jumper setting or on the I/F connector pin #10.

For configuration please refer to 7.2 and 7.3.

6.3.2. Pixel rate

The camera has 2 pixel clock frequencies, 30 MHz and 15 MHz. The pixel rate function selects the pixel clock for the data read out. The function has no influence on the internal scan rate and shutter setting. The max. scan rate with external trigger depends of the pixel clock.

The function can be selected by RS-232C, internal jumpers or on the I/F connector pin #31.

For configuration please refer to 7.2 and 7.3.

6.3.3. RS-232C on/off

This function makes it possible to disable the RS-232C input. It is useful when the camera is operated in an environment with RFI fields are present. When RS-232C is disabled, the binning and pixel rate can be changed by inputs on the I/F connector.

The function can be selected by internal jumpers or on the I/F connector pin #30.

For configuration please refer to 7.2 and 7.3.

6.3.4. Offset and Gain

Inside the camera there are potentiometers to adjust red, green and blue offset and gain.

They are used for the factory setting of the color balance. This is done for 3100K color temperature. Other adjustments can be done with the potentiometers. It is not recommended to torch the green gain and offset potentiometer, as they are the reference.

The adjustment is only for the factory setting. It has no function in the 4 user defined camera configurations and settings.

6.3.5. LED on rear

On the camera rear two LED indicators are found. The LED marked **POWER** will indicate that the power supply is on. The lower LED marked **BUSY** will light when external trigger is applied.

7. Configuring the Camera

All configuration of the CV-L105 camera is done via the RS-232C port, which is factory setting. Binning and pixel rate settings can also be controlled by TTL signals into the interface connector or internal jumpers. From the factory, the camera will start up with the factory default.

The factory setting is as follows:

Clock	30 MHz
Binning	2048 (Off)
Trigger	Internal
Mode	Scan
Scan time	32.350 msec
RGB gain and offset	To 3100K color balance (by internal potentiometers)

The factory settings cannot be changed by user.

There are 4 user defined configurations, which can be programmed by RS-232C and used as initial default settings.

7.1. RS-232C control.

Communication setting.

Baud Rate	9600 bps
Data Length	8 bit
Start Bit	1 bit
Stop Bit	1 bit
Parity	None
Xon/Xoff Control	None

RS 232C cable

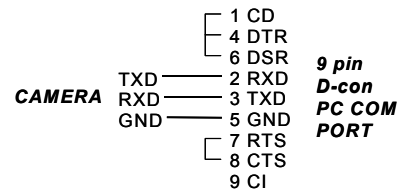

Fig. 16. RS-232C cable.

JAI provides a comprehensive software configuration tool, to configure the different functions of the camera.

The CV-L105 Camera Control Tool for Windows 98/NT/2000 can be downloaded from www.jai.com (For not released versions only from JAI Partner Site).

The control tool contents a camera control program and tools for making your own program. The program has a help function, which describes functions, and make it easy to use.



Fig. 17. Camera Control Tool

For the integrator and experienced user, the Camera Control Tool is much more than a program with a window interface- It also provides an easy and efficient ActiveX interface built for MS Windows 98, ME, NT and 2000. The OCX interface has the ability to connect to the camera using the serial interface of the PC by reading and writing properties for the camera. This integration requires simple programming skills within Visual Basic, Visual C++ or similar languages in a Microsoft Windows environment.

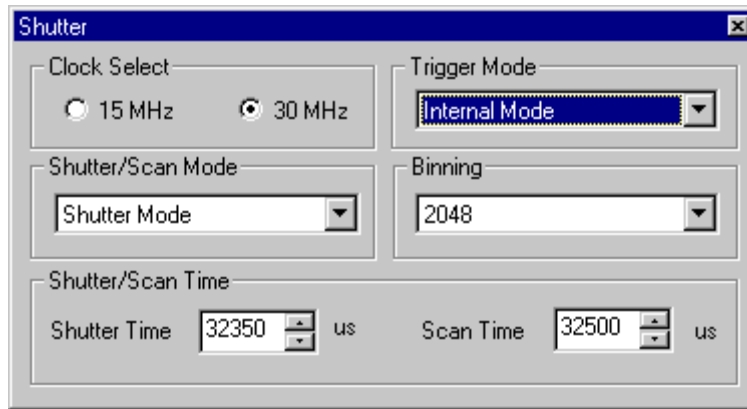

Fig. 18. Shutter window

7.1.1. Clock Select

With **Clock Select** two speeds can be selected, **15 MHz** or **30 MHz**.

The 15 MHz operation will limit the maximum line rate (scan rate) to 7 172 Hz. It is recommended when a cable length of more than 20 metres is used or in applications where high RFI fields may be experienced.

7.1.2. Binning

With **Binning** set to **2048** the full resolution of the CCD sensors is 2048 pixels. If a higher sensitivity is required, and a reduced resolution can be accepted, the binning function can be selected by switching to **1024**. As the readout section of the CCD sensor output, 2 adjacent pixels are added and read out as one single pixel.

The STROBE frequency is divided by 2 when the camera is operated in 1024 binning mode.

7.1.3. Trigger Mode

With **Trigger Mode** to **Internal**, the camera is configured to generate the trigger pulse internally. The **Scan time** and **Shutter Time** need to be configured for proper operation in this mode. In **External** mode, the camera is configured to accept an EXT TRIG pulse.

See also 6.2. Trigger modes.

7.1.4. Shutter/Scan Mode

With **Internal** trigger and **Shutter/Scan Mode** in **Shutter** mode, the camera will be set to expose for a pre-defined period of time set by **Shutter Time**. The scan interval (or scan rate) is set by **Scan Time**. In **Scan** mode, the exposure time is the same as the **Scan time**.

With **External** trigger and **Shutter/Scan Mode** in **Shutter** mode, the exposure is equal to the trigger low period. In **Scan** mode the exposure to the time interval between the external trigger pulses.

See also 6.2. Trigger modes.

7.1.5. Shutter/Scan Time

The **Shutter/Scan Time** controls the shutter time and scan time for internal trigger mode.

The range of setting for the **Shutter Time** is 1 μ s to (**Scan Time** - 150 μ s).

The range of **Scan Time** is 151 μ s to 32.35 ms.

Example, if **Scan Time** is set to 300 μ s the range of setting is up is 300 μ s - 150 μ s = 150 μ s.

The **Shutter/Scan Time** control has no function in external trigger mode.

7.1.6. Gain and offset adjustment

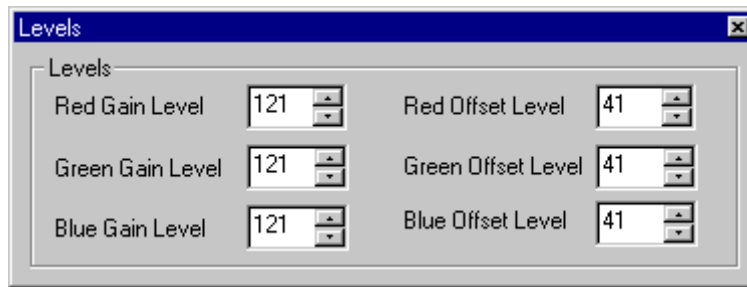

Fig. 19. Gain and Offset window

The individual gain and offset setting of each color is possible. This is required for adapting the white balance temperature for the 4 user configuration areas. For the factory default this setting has no function. It can only be adjusted with the internal potentiometers. The range of these settings is 0 - 255.

7.1.7. Communication and files

The communication between the PC and the camera is set up and controlled from the communication window.

The camera settings and configuration can be read into the 4 user areas in the camera EEPROM or to files from this window. Settings stored in files can be read and transferred to the program and read into the camera. For detailed descriptions, please download the camera control tool from www.jai.com and read the help description.

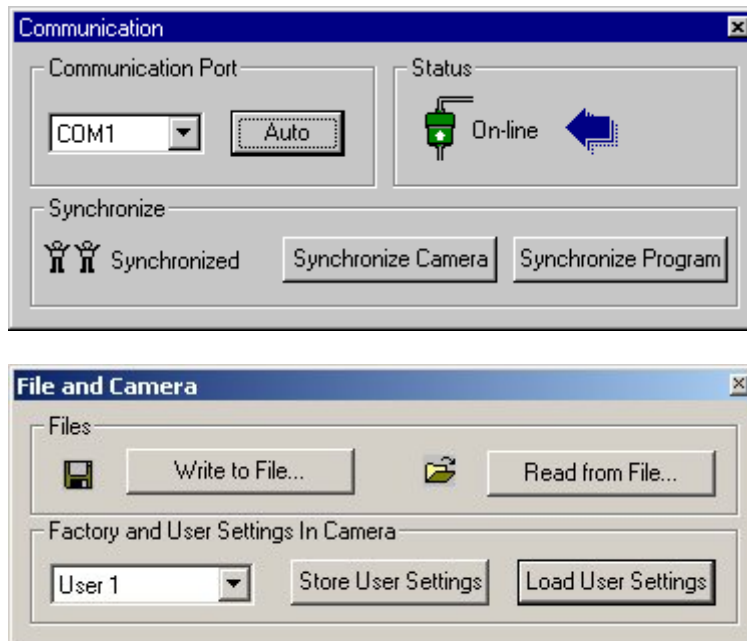

Fig. 20 Communication and File windows

7.2. Configuration via I/F connector and jumpers

The binning function, pixel rate and RS-232C function can be controlled by TTL inputs on the 68pin Hirose interface connector and with jumper settings. Below table describe the possible states of these inputs. Please refer to fig. 7. for principle.

Function	RS-232C contr.			Binning			Clock		Remarks
	JP3	JP4	Pin #30	JP1	JP2	Pin #10	JP5	Pin #31	
RS-232C control only	O	S	H	O	O	H	O	H	Factory setting. RS-232C enabled
RS-232C enable/disable by I/F pin #30	S	O	L H	O	O	H	O	H	#30 low for RS-232C enabled #30 high for RS-232C disabled
Binning fixed at 1024 by JP2	S	O	H	O	S	H	x	H	JP2 closed for 1024
Binning select by I/F pin #10				S	O	H L			#10 high for 2048 #10 low for 1024
Pixel clock select by JP5				O S	H	JP5 open for 30 MHz JP5 closed for 15 MHz			
Pixel clock select by I/F pin #31	S	O	H	x	x	H	O S O	H H L	#31 high for 30 MHz #31 low for 15 MHz

O = jumper open
 S = jumper short
 H = input high. (open. 5V by the internal 4.7 kΩ pull-up resistor)
 L = input low. (closed to GND)
 x = do not care

7.3. Potentiometers and jumpers placing

There are 5 solder jumpers on the main board (PK8234B), which are accessible for the user. On the board (PK8235B) 7 potentiometers are found. The top one marked A/D is for factory adjustment. Do not touch it. The red, green and blue gain and offset potentiometers is factory adjusted to white color balance at 3100K. It is used in factory setting configuration. As the green gain and offset is reference, do not touch it.

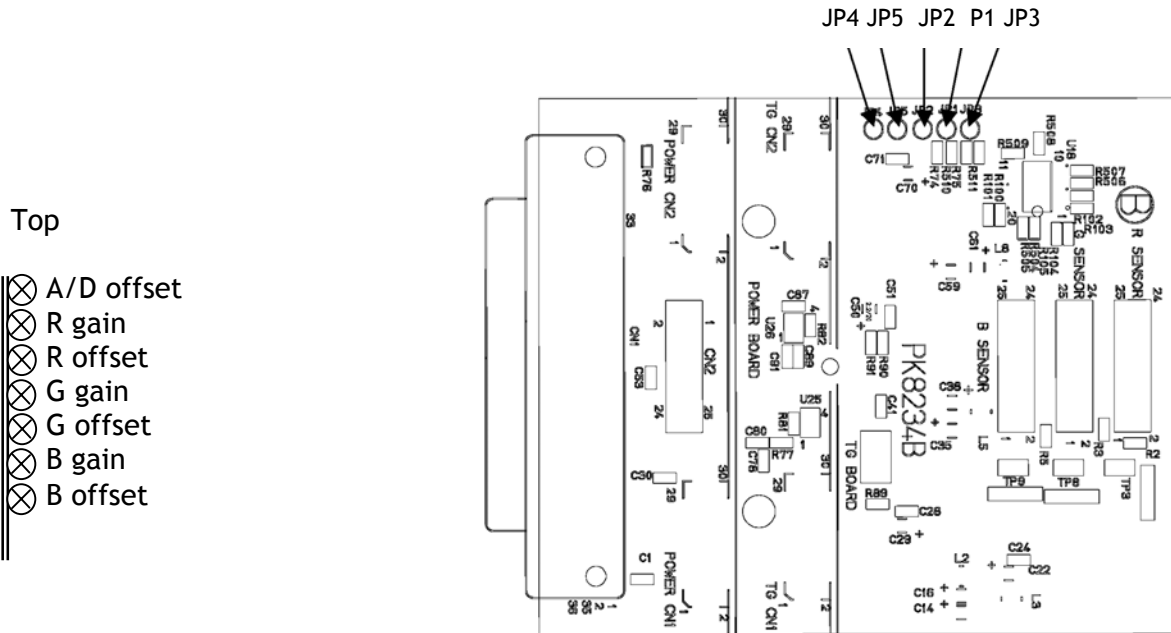

Fig. 21. Potentiometers and jumpers placing

8. External Appearance and Dimensions

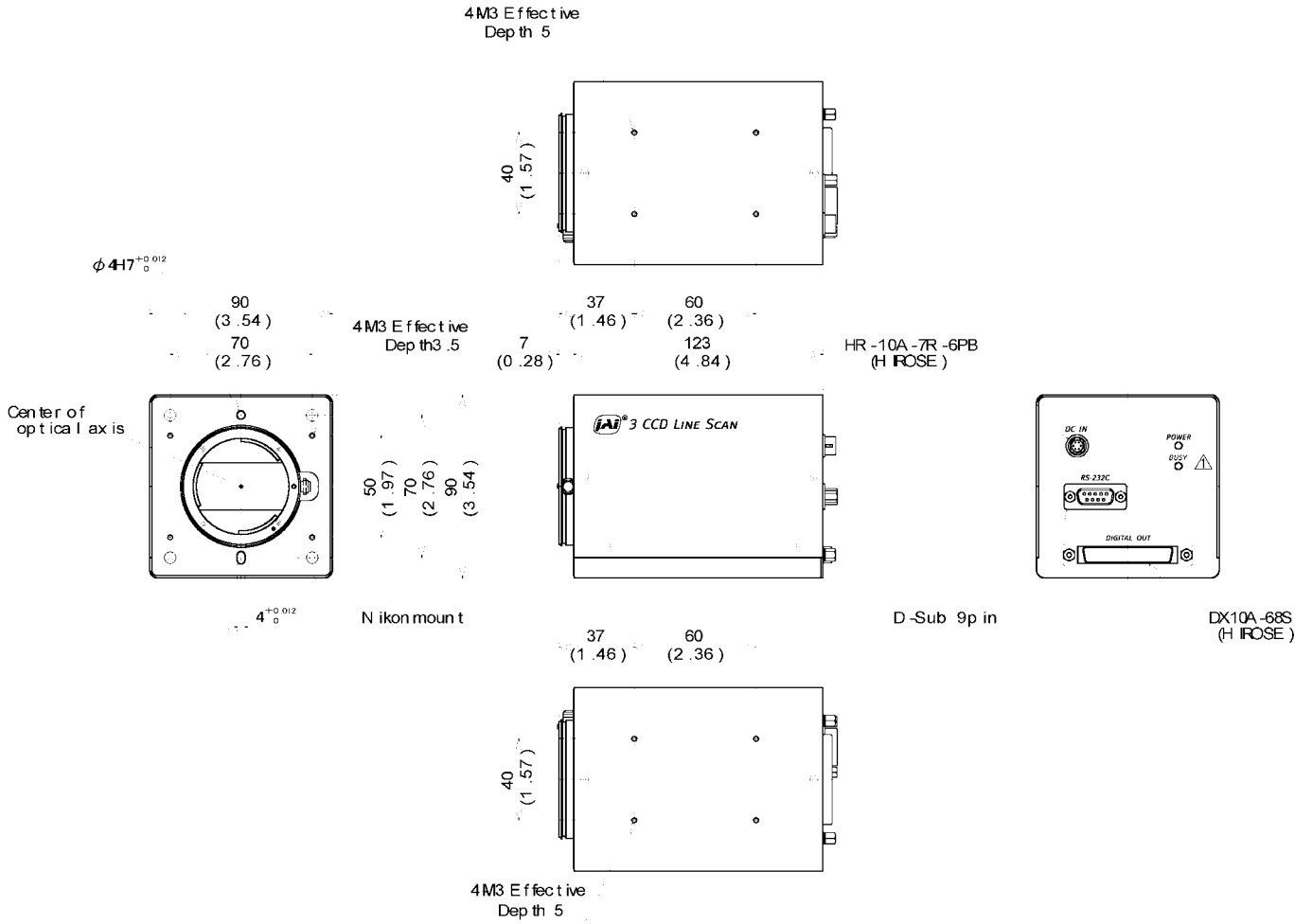

Fig. 22. Outlines

9. Specifications

9.1. Specifications table

Specifications	CV-L105
Scanning system	Line scan
Pixel clock	15 or 30 MHz, user selectable
Line rate (scan rate)	Up to 7172 lines/sec at 15 MHz, and up to 14285 lines/sec at 30 MHz
CCD sensor	3 x 2048 line scan sensors mounted on an RGB prism
Sensing area	28.7 mm x 14 μ m
Effective pixels	3 x 2144
Pixels in video output	3 x 2048
Cell size	14 μ m x 14 μ m
Prism block	Dichroic beam splitter. Centre wavel. Red 630 nm, Green 535 nm, Blue 450 nm
CCD alignment precision	Typ. 0,5 pixel, Max 1 pixel
Sensitivity on sensor Radiometric at 3100K	6.7 mV/nj/cm ² . (7.2 LSB/nj/cm ² at 8 bit)
Sensitivity on sensor Photometric at 3100K	400 Lux. (Exposure time 1 msec. Max. gain, 100% video on green)
S/N ratio	15 MHz. R: 53 dB, G: 56 dB, B: 50 dB 30 MHz. R: 47 dB, G: 50 dB, B: 44 dB
Video output	3 x 8 bit EIA-644 Low Voltage Differential Signalling LVDS. Based on NS DS90C032.
Gain range	12 dB
Trigger input	EIA-644 LVDS. Based on NS DS90C031
STROBE output	(for latching video into frame grabber) EIA-644 LVDS
LEN output	(valid video duration) EIA-644 LVDS
Trigger modes	Continuous, Pulse Width Control, Edge Pre-select
Functions controlled by input signal on interface connector	Pixel rate and binning RS-232C control enable/disable
Functions input	TTL levels. Internal 4.7 k Ω pull-up
Functions controlled by RS- 232C	Pixel clock select, Binning, Trigger mode, Scan rate, Shutter speed, individual RGB gain, individual RGB offset.
Communication baud rate	9600
Diagnostics	LED for power, LED for trigger
Operating temperature	-5°C to +45°C
Humidity	20 - 80% non-condensing
Storage temp./humidity	-25°C to +60°C/20 - 80% non-condensing
Lens mount	Nikon F-mount
Power	12V DC \pm 5% 12W (1A)
Dimensions	90 x 90 x 123 mm (HxWxD)
Weight	1100 g

9.2. Spectral Sensitivity

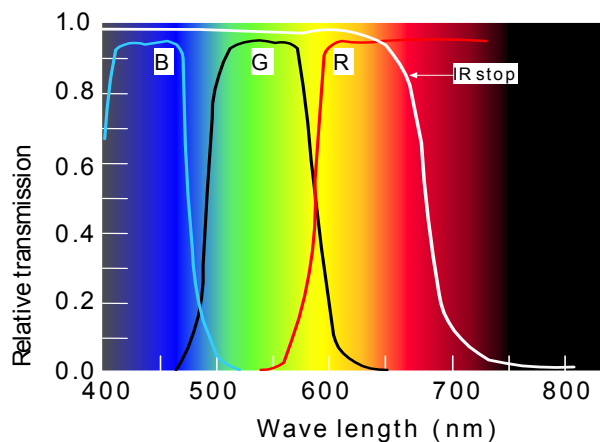

Fig. 23. Spectral sensitivity.

10. Users Record

Camera type: CV-L105
Revision: (Revision A)
Serial No.
Software version.

For camera revision history, please contact your local JAI distributor.

Users Mode Settings.

Users Modifications.



DECLARATION OF CONFORMITY
AS DEFINED BY THE COUNCIL DIRECTIVE
89/336/EEC
EMC (ELECTROMAGNETIC COMPABILITY)
WE HEREWITH DECLARE THAT THIS PRODUCT
COMPLIES WITH THE FOLOWING PROVISIONS APPLYING TO IT.
EN-50081-1
EN-50082-1

Company and product names mentioned in this manual are trademarks or registered trademarks of their respective owners.
JAI A-S cannot be held responsible for any technical or typographical errors and reserves the right to make changes to products and documentation without prior notification.

JAI A-S, Denmark
Produktionsvej 1, 2600 Glostrup
Copenhagen, Denmark
Phone +45 4457 8888
Fax +45 4491 8880
www.jai.com

JAI Corporation, Japan
German Industry Center
1-18-2 Hakusan, Midori-ku
Yokohama,
Kanagawa 226-0006, Japan
Phone +81 45 933 5400
Fax +81 45 931 6142
www.jai.com

JAI America, Inc., USA
800 West Cummings Park
Woburn, MA 01801
Suite 1250
Phone (Toll-Free)
+1 877 472-5909
www.jai.com



THE MECHADEMIC COMPANY

Free Manuals Download Website

<http://myh66.com>

<http://usermanuals.us>

<http://www.somanuals.com>

<http://www.4manuals.cc>

<http://www.manual-lib.com>

<http://www.404manual.com>

<http://www.luxmanual.com>

<http://aubethermostatmanual.com>

Golf course search by state

<http://golfingnear.com>

Email search by domain

<http://emailbydomain.com>

Auto manuals search

<http://auto.somanuals.com>

TV manuals search

<http://tv.somanuals.com>