

JBL

**JBL CINEMA SOUND
SPEAKERS**

CS600SAT

OWNER'S GUIDE



CS600SAT OWNER'S GUIDE

TABLE OF CONTENTS

- 3** Introduction
- 3** Included
- 3** Planning Your System
- 3** Placement
- 4** Wall-Mounting the Satellites
- 5** Connections
- 5** Maintenance and Service
- 6** Specifications

THANK YOU FOR CHOOSING JBL

For more than 60 years, JBL has been involved in every aspect of music and film recording and reproduction, from live performances to the recordings you play in your home, car or office.

We're confident that the JBL speakers you have chosen will provide every note of enjoyment that you expected – and that when you think about purchasing additional audio equipment for your home, car or office, you will once again choose JBL.

Please take a moment to register your product on our Web site at www.jbl.com. It enables us to keep you posted on our latest advancements, and helps us to better understand our customers and build products that meet their needs and expectations.

INCLUDED

Carefully unpack the system. If you suspect damage from transit, report it immediately to your dealer and/or delivery service. Keep the shipping carton and packing materials for future use. Open the package and verify the following contents:

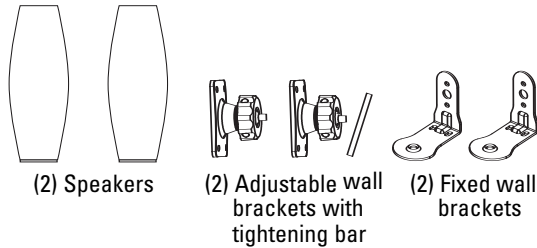

PLANNING YOUR SYSTEM

Before deciding where to best place your speakers, survey your room and study Figures 1 and 2.

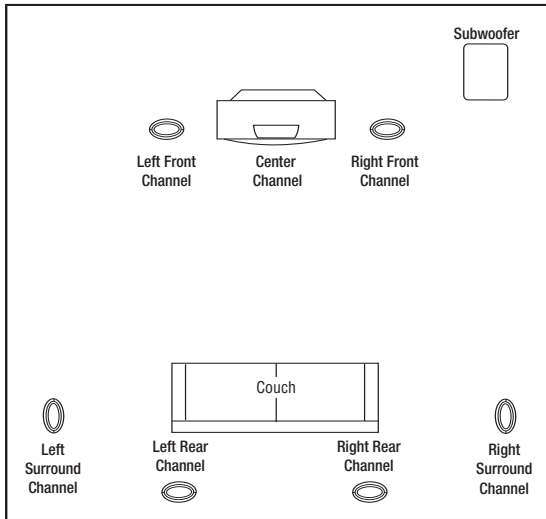

Figure 1. In this overhead view of a typical installation, satellite speakers are used to reproduce sound for the front and surround channels. The center channel reproduces sound and dialogue. The powered subwoofer provides bass for effects and music.

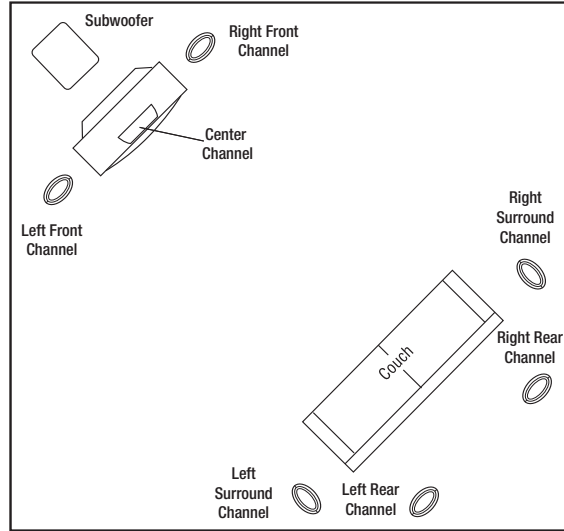

Figure 2. This figure shows an alternative layout, which may be more suitable for some rooms.

PLACEMENT

NOTE: The CS600SAT can be placed directly on a shelf, or mounted on a wall using the included wall brackets.

As Left and Right Front Channels

For left and right front channels, place one satellite to the left and another to the right of the television, as shown in Figure 1. Since the speakers are magnetically shielded, you can place them very close to the TV without worrying about the magnetic field distorting the picture.

As Surround Channels

For left and right surround channels, place one speaker on the left and another on the right, to the side of or slightly behind the listening area. The surround speakers should be mounted at a height of between 5 ft. (1.5m) and 7 ft. (2m).

In 7-channel configurations, place the rear channel(s) behind the listening position, as shown in Figures 1 and 2.

NOTE: A powered subwoofer will add impact and realism to both music and film soundtracks. Contact your JBL dealer for recommendations on subwoofer models for your application.

Mounting on Floor Stands

Optional floor stands are available, should you prefer to place your CS600SAT satellites on the floor; see your dealer or visit www.jbl.com for more information.

WALL-MOUNTING THE SATELLITES

The CS600SAT is designed to be mounted on the wall. There is a fixed-mount wall bracket and an adjustable wall bracket provided for each satellite. Each speaker bracket will require up to four 1-1/2" #10 wood screws; each screw should be fastened to a wall stud. If a wall stud is unavailable, install an anchor appropriate for a 1-1/2" #10 screw.

NOTE: The customer is responsible for the correct selection and use of mounting hardware (available through hardware stores) that will ensure the proper and safe wall-mounting of the speakers.

Fixed-Mount Wall Bracket

Step 1. Mark the positions on the wall where you would like to place the mounting screws.

Step 2. Attach the bracket to the wall using two screws (not included).

Step 3. Remove the rubber ring on the bottom of the satellite, and seat the satellite speaker onto the back bracket.

Step 4. Attach 1/4" -20 screw into insert on bottom of speaker and tighten.

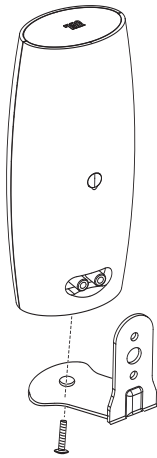

Adjustable Wall Bracket

Step 1. Remove cap over threaded insert on rear of speaker.

Step 2. Mark the positions on the wall where you would like to place the mounting screws.

Step 3. Place bracket against the wall and fasten four 1-1/2" #10 wood screws through the bracket's screw holes into the wall. If a wall stud is not available, use an appropriate anchor.

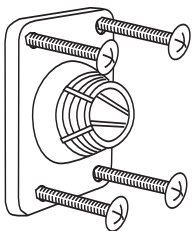

Step 4. Unscrew round collar (C) from bracket (A).

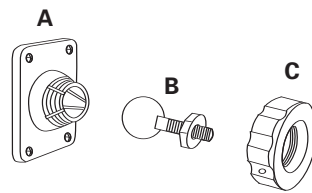

Step 5. Screw the ball and shaft assembly (B) to the 1/4"-20 insert on the back of the satellite (do not use the bottom insert on the speaker). Back out 1/2 of a turn and tighten the nut against the speaker. If the ball and shaft assembly is not backed out before tightening the nut, performing Step 8 below may dislodge the threaded insert in the speaker housing and permanently damage the speaker.

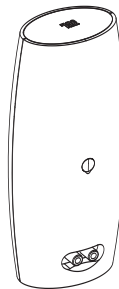

Step 6. Attach speaker wire as shown on page 5.

Step 7. Drop round collar (C) over ball and shaft assembly (B) that is mounted to the speaker with the finished side of the collar facing the rear of the speaker.

Step 8. Carefully push the ball straight into the socket mounted on the wall, angle the speaker as desired and tighten the collar using the enclosed metal bar.

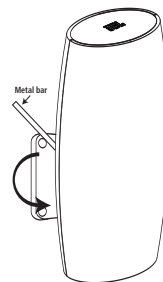

Figure 3. Bracket on wall.

CONNECTIONS

After placing the speakers, you are ready to connect your system. First, turn off all audio-system power. Use high-quality speaker wire to make your connections; #18-gauge speaker wire with polarity coding is recommended. For longer distances, #16-gauge or heavier wire is recommended. The side of the wire with a ridge or other coding is usually considered positive polarity (i.e., +). Also, consult the owner's manuals that were included with your amplifier or receiver to confirm connection procedures. Observe polarities when making speaker connections, as shown in Figure 4. Connect each + terminal on the back of the amplifier or receiver to the respective + (red) terminal on each speaker. Connect the - (black) terminals in the same way.

Important!

Do not reverse polarities (i.e., + to -, or - to +) when making connections. Doing so will cause poor imaging and diminished bass response. Be certain that positive and negative wire strands are completely isolated to avoid short circuits that may damage your equipment.

NOTE: On certain models using hexagonal terminal nuts, a small socket wrench is provided to help in properly tightening the terminals. Hand-tighten only and do not overtighten.

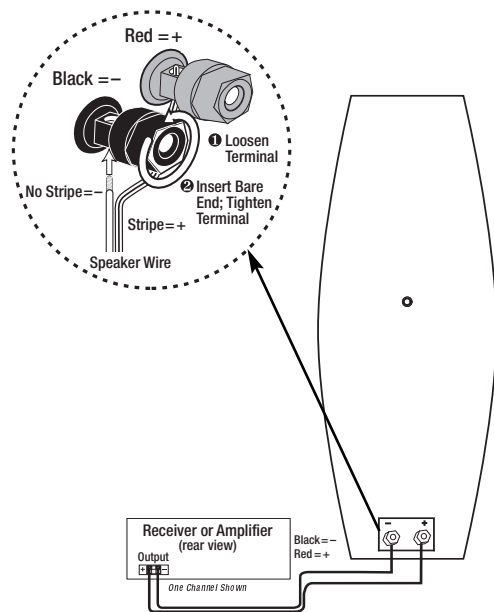

Figure 4. Wiring diagram shows polarity connections for one channel of a home theater system.

MAINTENANCE AND SERVICE

The enclosure may be cleaned using a soft cloth to remove fingerprints or to wipe off dust.

All wiring connections should be inspected and cleaned or remade periodically. The frequency of maintenance depends on the metals involved in the connections, atmospheric conditions and other factors, but once per year is the minimum.

If a problem occurs, make sure that all connections are properly made and clean. If a problem exists in one loudspeaker, reverse the connection wires to the left and right system. If the problem remains in the same speaker, then the fault is with the loudspeaker. If the problem appears in the opposite speaker, the cause is in another component or cable. In the event that your speaker ever needs service, contact your local JBL dealer or distributor, or visit www.jbl.com for a service center near you.

SPECIFICATIONS

CS600SAT

Frequency Range (-6dB):	100Hz – 20,000Hz
Recommended Amplifier Power Range:	10 – 100 Watts
Sensitivity (2.83V @ 1 meter)	88dB
Nominal Impedance:	8Ω
Crossover Frequency:	3.0kHz; 12dB/octave
Midrange Driver:	Dual 3-1/2" (89mm) magnetically shielded
High-Frequency Driver:	1/2" (13mm) Titanium-laminate, magnetically shielded
Dimensions (H x W x D):	11-3/8" x 5-5/8" x 3-3/8" (289mm x 131mm x 86mm)
Weight:	3.2 lb (1.5kg)

Features, specifications and appearance are subject to change without notice.

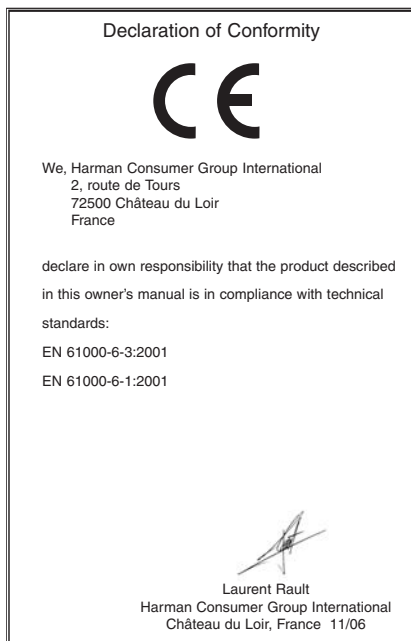

JBL is a trademark of Harman International Industries, Incorporated, registered in the United States and/or other countries. Pro Sound Comes Home is a trademark of Harman International Industries, Incorporated.

JBL	PRO SOUND COMES HOME™
Harman Consumer Group, Inc., 250 Crossways Park Drive, Woodbury, NY 11797 USA 8500 Balboa Boulevard, Northridge, CA 91329 USA 2, route de Tours, 72500 Château du Loir, France 516.255.4JBL (4525) (USA only) www.jbl.com © 2006 Harman International Industries, Incorporated. All rights reserved. Part No. 406-000-05545-E	
H A Harman International Company	

Free Manuals Download Website

<http://myh66.com>

<http://usermanuals.us>

<http://www.somanuals.com>

<http://www.4manuals.cc>

<http://www.manual-lib.com>

<http://www.404manual.com>

<http://www.luxmanual.com>

<http://aubethermostatmanual.com>

Golf course search by state

<http://golfingnear.com>

Email search by domain

<http://emailbydomain.com>

Auto manuals search

<http://auto.somanuals.com>

TV manuals search

<http://tv.somanuals.com>