

**JBL**

**D E C A D E™**

**D 3 8 , D 3 1 5**



**S I M P L E S E T U P G U I D E**

**thank you** for choosing JBL. For more than 50 years, JBL has been involved in every aspect of music and film recording and reproduction, from live performances to monitoring the recordings you play in your home, car or office.

We're confident that the JBL loudspeakers you have chosen will provide every note of enjoyment that you expected – and that when you think about purchasing additional audio equipment for your home, car or office, you will once again choose JBL.

Please take a moment to complete the enclosed profile card. It enables us to keep you posted on our latest advancements, and helps us to better understand our customers and to build products that meet their needs and expectations.

JBL Consumer Products

# one. Speaker Placement

D38

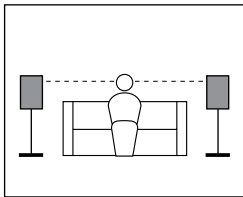
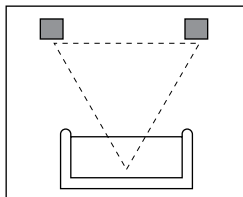

D315

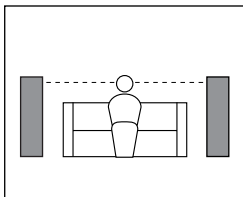
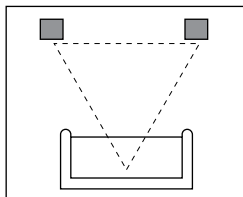

# two. Speaker Connections

## Connection Tips

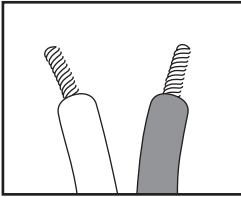

Speakers and electronics terminals have corresponding (+) and (-) terminals. It is important to connect both speakers identically: (+) on the speaker to (+) on the amplifier and (-) on the speaker to (-) on the amplifier. Wiring “out of phase” results in thin sound, weak bass and a poor stereo image.

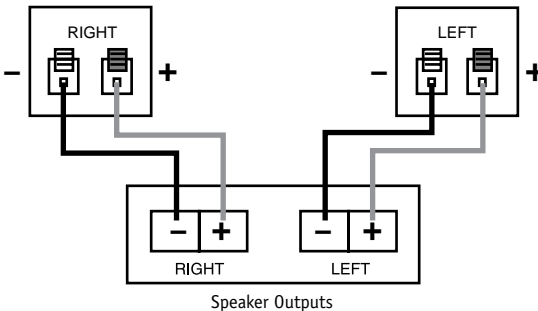

## Troubleshooting

**If there is no sound from any of the speakers, check the following:**

- Receiver/amplifier is on and a source is playing.
- Review proper operation of your receiver/amplifier.

**If there is no sound coming from one speaker, check the following:**

- Check the “Balance” control on your receiver/amplifier.
- Check all wires and connections between receiver/amplifier and speakers.
- Make sure all wires are connected. Make sure none of the speaker wires are frayed, cut or punctured.

**If the system plays at low volumes but shuts off as volume is increased, check the following:**

- Check all wires and connections between receiver/amplifier and speakers.
- Make sure all wires are connected. Make sure none of the speaker wires are frayed, cut or punctured.
- If more than one pair of main speakers is being used, check the minimum impedance requirements of your receiver/amplifier.

**If there is low bass output, check the following:**

- Make sure the polarities (+ and -) of the left and right “Speaker Inputs” are connected properly.

# Specifications

	<b>D38</b>	<b>D315</b>
<b>Frequency Response (-6dB):</b>	50Hz - 20kHz	40Hz - 20kHz
<b>Recommended Maximum Amplifier Power*:</b>	175 watts	250 watts
<b>Sensitivity @ 1 watt/1 meter:</b>	92dB	96dB
<b>Nominal Impedance:</b>	8 ohms	8 ohms
<b>Woofers:</b>	8"	15"
<b>Midrange:</b>	4"	4"
<b>Tweeters:</b>	2"	2"
<b>Dimensions (H x W x D):</b>	16-3/4 x 10-3/4 x 12 inches (425 x 273 x 305mm)	30-7/8 x 16-1/4 x 11-1/2 inches (784 x 413 x 292mm)
<b>Weight (each):</b>	17 lbs/7.7 kg	35 lbs/15.9 kg

\*The maximum recommended amplifier power rating will ensure proper system headroom to allow for occasional peaks. We do not recommend sustained operation at these maximum power levels.

Occasional refinements may be made to existing products without notice, but will always meet or exceed original specifications unless otherwise stated.



JBL Consumer Products  
250 Crossways Park Drive, Woodbury, NY 11797  
8500 Balboa Boulevard, Northridge, CA 91329  
1-800-336-4JBL (4525) (USA only)  
www.jbl.com

© 1998 JBL, Incorporated.  
JBL is a registered trademark  
of JBL, Incorporated.  
9/98 Part No.: D38,D3150M

**H** A Harman International Company

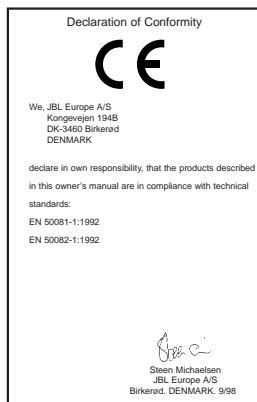

## Free Manuals Download Website

<http://myh66.com>

<http://usermanuals.us>

<http://www.somanuals.com>

<http://www.4manuals.cc>

<http://www.manual-lib.com>

<http://www.404manual.com>

<http://www.luxmanual.com>

<http://aubethermostatmanual.com>

Golf course search by state

<http://golfingnear.com>

Email search by domain

<http://emailbydomain.com>

Auto manuals search

<http://auto.somanuals.com>

TV manuals search

<http://tv.somanuals.com>