

JBL **MARINE**

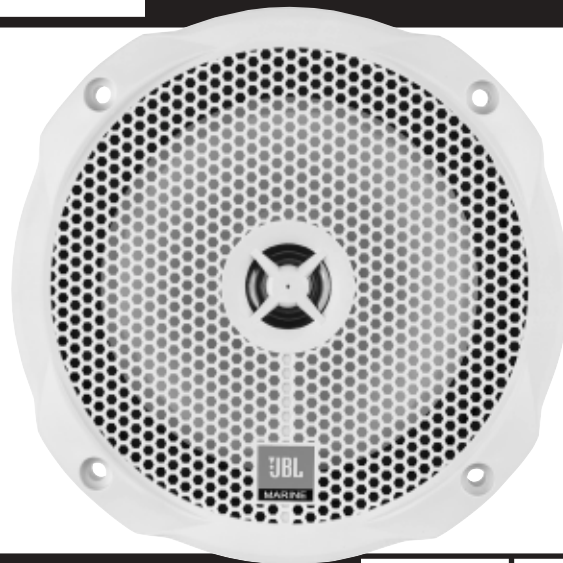

Marine Speaker Owner's Manual **MS610** **MS620** **MS920**

Installation Warnings and Tips JBL Marine Speakers

About These Instructions:

Installation of stereo components can require extensive experience with a variety of mechanical and electrical procedures. Although these instructions explain how to install JBL Marine speakers in a general sense, they do not show the exact installation methods for your particular application. If you do not feel you have the experience, do not attempt the installation yourself, but instead ask your authorized JBL marine-audio dealer about professional installation options.

Loud Music and Hearing:

Playing loud music in a marine environment can permanently damage your hearing, as well as hinder your ability to hear marine traffic. The maximum volume levels achievable with JBL speakers, combined with high-power amplification, may exceed safe levels for extended listening. JBL accepts no liability for hearing loss, bodily injury, or property damage as a result of use or misuse of this product.

General Care:

The loudspeaker grilles may be cleaned with a damp cloth. Do not use any cleaners or solvents on the grilles or the speaker cones.

About Power Handling:

JBL Marine speakers will produce reasonable volume levels with little amplifier power. Moreover, adding an amplifier to drive your speakers and a subwoofer will enhance your system's dynamic range, and help overcome ambient noise.

Although JBL Marine speakers are designed to handle the power of a dedicated amplifier driven at or below its rated power, make sure the amplifier is not driven far above its rated power. Doing so will "clip" the output signal and can damage any speaker. Distorted or "fuzzy" sound from your speakers is an indication that the amplifier has exceeded its rated power, and you should reduce the volume level.

Installation Tips:

- Always wear protective eyewear when using any tools.
- Turn off all audio components and other electrical devices before you start. Disconnect the negative (-) lead from your marine battery.
- Keep speakers in their package until final installation. When moving a speaker, always rest it with the cone or dome facing up. Never use force to install any speaker.
- Check clearances on both sides of a planned mounting surface before drilling any holes or installing any screws. Remember that the screws can extend behind the surface.
- At the installation sites, locate and make a note of all fuel lines and electrical wiring. Use extreme caution when cutting or drilling in and around these areas.
- Before drilling or cutting holes, use a utility knife to remove unwanted fabric or vinyl to keep material from snagging in a drill bit or saw.
- The stainless-steel hardware provided with your JBL Marine speakers has been chosen to resist rust and corrosion.

Installation JBL Marine Speakers

Figure 1. Mounting the JBL MS620 marine speaker. The JBL MS920 and MS610 marine speakers (not shown) mount in a similar way.

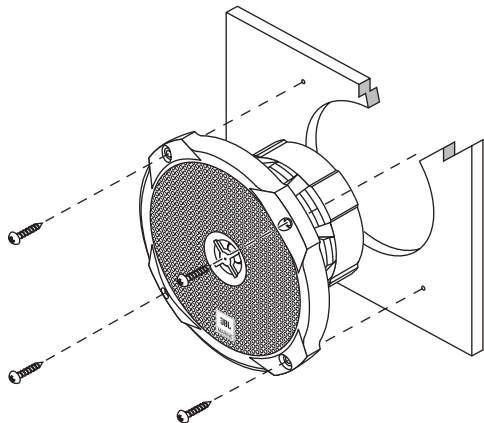



Specifications JBL Marine Speakers

	MS610
Type	6-1/2" dual-cone
Speaker Impedance	4 ohms
Power Handling	35W RMS, 105W Peak
Sensitivity (2.83V, 1m)	90dB
Frequency Response	55Hz – 18kHz
Mounting Depth	2-3/8" (61mm)
Cut-Out Diameter	5" (127mm)

	MS620
Type	6-1/2" 2-way
Speaker Impedance	4 ohms
Power Handling	60W RMS, 180W Peak
Sensitivity (2.83V, 1m)	91dB
Frequency Response	55Hz – 20kHz
Mounting Depth	2-3/8" (61mm)
Cut-Out Diameter	5" (127mm)

	MS920
Type	6" x 9" 2-way
Speaker Impedance	4 ohms
Power Handling	100W RMS, 300W Peak
Sensitivity (2.83V, 1m)	91dB
Frequency Response	50Hz – 21kHz
Mounting Depth	3-1/8" (80mm)
Cut-Out Diameter	6" x 8-13/16" (153mm x 224mm)

JBL Consumer Products • 250 Crossways Park Drive, Woodbury, NY 11797 USA 516.255.4JBL (4525) www.jbl.com	
©2003 Harman International Industries, Incorporated JBL is a registered trademark of Harman International Industries, Incorporated	
 Part No. MS610/620/9200M 11/03	
 A Harman International Company	

Declaration of Conformity



We, Harman Consumer International
2, route de Tours
72500 Chateau-du-Loir
France

declare in own responsibility that the products described in this owner's manual are in compliance with technical standards:

EN 61000-6-3:2001
EN 61000-6-1:2001

Emmanuel Millot
Harman Consumer International
Chateau-du-Loir, France 11/03

Free Manuals Download Website

<http://myh66.com>

<http://usermanuals.us>

<http://www.somanuals.com>

<http://www.4manuals.cc>

<http://www.manual-lib.com>

<http://www.404manual.com>

<http://www.luxmanual.com>

<http://aubethermostatmanual.com>

Golf course search by state

<http://golfingnear.com>

Email search by domain

<http://emailbydomain.com>

Auto manuals search

<http://auto.somanuals.com>

TV manuals search

<http://tv.somanuals.com>