



## OWNER'S GUIDE

PRODUCT LINE:

*Simply Cinema*

MODEL NUMBER:

**SCS 140, SCS 146, DSC 1000 (230V)**

**DESIGN GOAL:** Bring the thrill of live performance and movie sound to the home environment by calling on JBL's professional engineering leadership.

**SATELLITE TYPE:** Titanium-laminate-dome tweeter, sealed enclosure

**SUBWOOFER TYPE:** Bass-reflex enclosure

**PORT DESIGN:** FreeFlow™ flared

**PROFESSIONAL REFERENCE:** Cinema Loudspeaker Series

# JBL

# THANK YOU FOR CHOOSING JBL

For more than 55 years, JBL has been involved in every aspect of music and film recording and reproduction, from live performances to the recordings you play in your home, car or office.

We're confident that the JBL system you have chosen will provide every note of enjoyment that you expected – and that when you think about purchasing additional audio equipment for your home, car

or office, you will once again choose JBL.

**For connection of the DSC 1000, please refer to the DSC 1000 Source manual.**

JBL Consumer Products

## INCLUDED

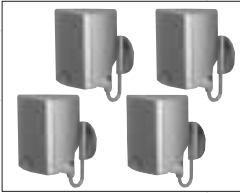

Four satellites for left/right front and surrounds. Wall-mount brackets. SCS 146 contains an additional satellite to be used as surround back.

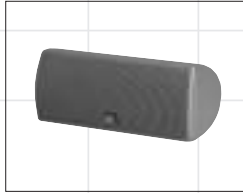

One center channel speaker .



Powered subwoofer.

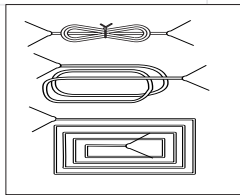

Two 6.1-meter (20-foot) speaker cables for connection from receiver to subwoofer.

Three 4.6-meter (15-foot) speaker cables for connection from subwoofer to front speakers and center speaker.

Two (Three in SCS 146) 12.2-meter (40-foot) speaker cables for connection from receiver to left and right rear satellites and surround back speaker. (SCS 146 only)

### CAUTION

**RISK OF ELECTRIC SHOCK  
DO NOT OPEN**

**CAUTION:** To prevent electric shock, do not remove the grounding plug on the power cord, or use any plug or extension cord that does not have a grounding plug provided.

Make certain that the AC outlet is properly grounded. Do not use an adapter plug with this product.

The lightning flash with arrowhead symbol, within an equilateral triangle, is intended to alert the user to the presence of uninsulated "dangerous voltage" within the product's enclosure that may be of sufficient magnitude to constitute a risk of electric shock to persons.



The exclamation point within an equilateral triangle is intended to alert the user to the presence of important operating and maintenance (servicing) instructions in the literature accompanying the appliance.



### Declaration of Conformity



We, Harman Consumer International  
2, route de Tours  
72500 Château-du-Loir  
France

declare in own responsibility, that the product described in this owner's manual is in compliance with technical standards:

EN 60965:1998  
EN 55013/A14:1999  
EN 55020/A14:1999  
EN 61000-3-2/A14:2000  
EN 61000-3-3/1:1995  
EN 50081-1:1992  
EN 50082-1:1992



Gary Mardell  
JBL  
Harman Consumer International  
France, 08/03

# SPEAKER PLACEMENT

## Front Speakers

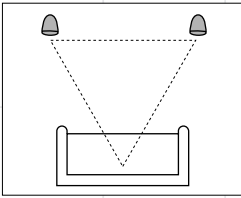

## Center Channel Speaker

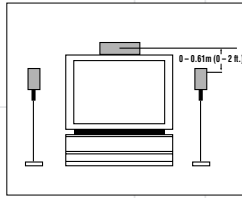

## Subwoofer

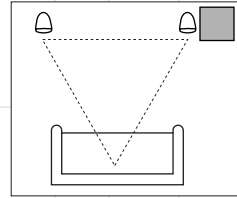

## Surround Speakers (SCS 140)

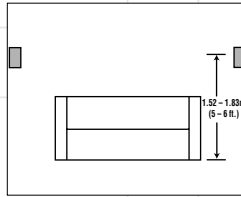
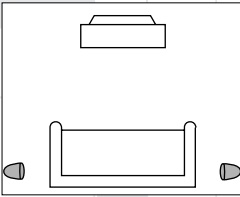

## Surround Speakers (SCS 146)

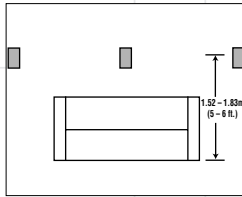
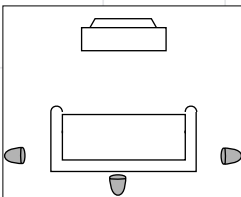

The front speakers should be placed the same distance from each other as they are from the listening position. They should be placed at about the same height from the floor as the listeners' ears will be, or they may be angled toward the listeners.

The center channel speaker should be placed slightly behind the front left and right speakers, and no more than two feet above or below the tweeters of the left and right speakers. It is often convenient

to set the center speaker on top of the television set, as shown in the drawing. Use the supplied support leg to aim it toward the listener by screwing the leg in to angle the speaker up, or unscrewing the leg slightly to angle the speaker down.

The two surround speakers should be placed slightly behind the listening position and, ideally, should face each other and be at a level higher than the listeners' ears. If that is not possible, they may be

placed on a wall behind the listening position, facing forward. The surround back speaker (in SCS 146 only) should be placed behind the listening position, facing the center speaker. The surround speakers should not call attention to themselves.

Experiment with their placement until you hear a diffuse, ambient sound accompanying the main-program material heard in the front speakers.

The low-frequency material reproduced by the subwoofer is mostly omnidirectional, and this speaker may be placed in a convenient location in the room. However, the best reproduction of bass will be heard when the subwoofer is placed in a corner along the same wall as the front speakers. Experiment with subwoofer placement by temporarily placing the subwoofer in the listening position and moving around the room until the bass reproduction is best. Place the subwoofer in that location.

# MOUNTING OPTIONS

## Satellites and Surrounds

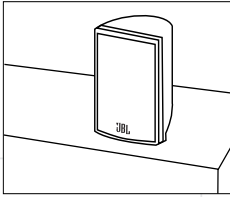

On shelves.

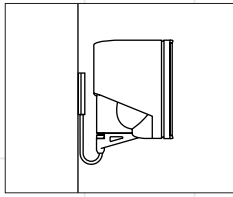

On the wall. Wall brackets are included.

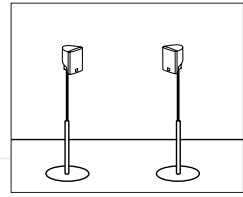

On optional stands (FS300S).

## Wall-Mounting

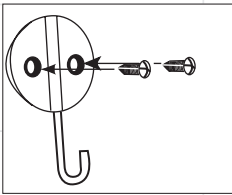

Attach plate to wall. The brackets should be placed, if possible, so that the screws will fasten into a wooden wall stud. If that is not possible, use properly selected wall anchors.

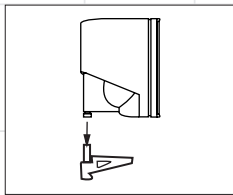

Slide speaker onto support.

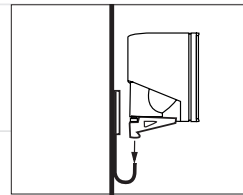

Place speaker and support on wall plate.

The customer is responsible for proper selection and use of mounting hardware, available through hardware stores, to properly and safely wall-mount the speakers.

# SPEAKER CONNECTIONS

## Connection Tips

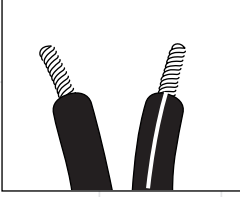

Separate and strip the ends of the speaker wire as shown. Speakers and electronics terminals have corresponding (+) and (-) terminals. Most manufacturers of speakers and electronics, including JBL, use red to denote the (+) terminal and black for the (-) terminal. The (+) lead of the speaker wire is noted with a stripe. It is important to connect all speakers identically: (+) on the speaker to (+) on the amplifier and (-) on the speaker to (-) on the amplifier. Wiring “out of

phase” results in thin sound, weak bass and a poor stereo image.

With the advent of multichannel surround-sound systems, connecting all of the speakers in your system with the correct polarity remains equally important in order to preserve the proper ambience and directionality of the program material.

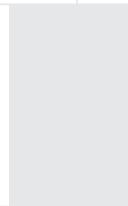

## Dolby\* Pro Logic\* (Non-Digital) – Speaker Level (SCS 140 and SCS 146)

Use this installation method for Dolby Pro Logic applications (not Dolby Digital, DTS® or other digital processing), where the receiver/processor does not have a subwoofer output, or a volume-controlled preamp (line-) level output: Connect your receiver or amplifier's front left and right speaker terminals to the left and right terminals on the subwoofer that are marked "High Level In." Connect the left and right terminals on the subwoofer that are marked "High Level Out" to the corresponding terminals on the back of your front left and right speakers. Connect your receiver or amplifier's center, left and right surround-speaker terminals to the corresponding terminals on the back of your center, left and right surround speakers.

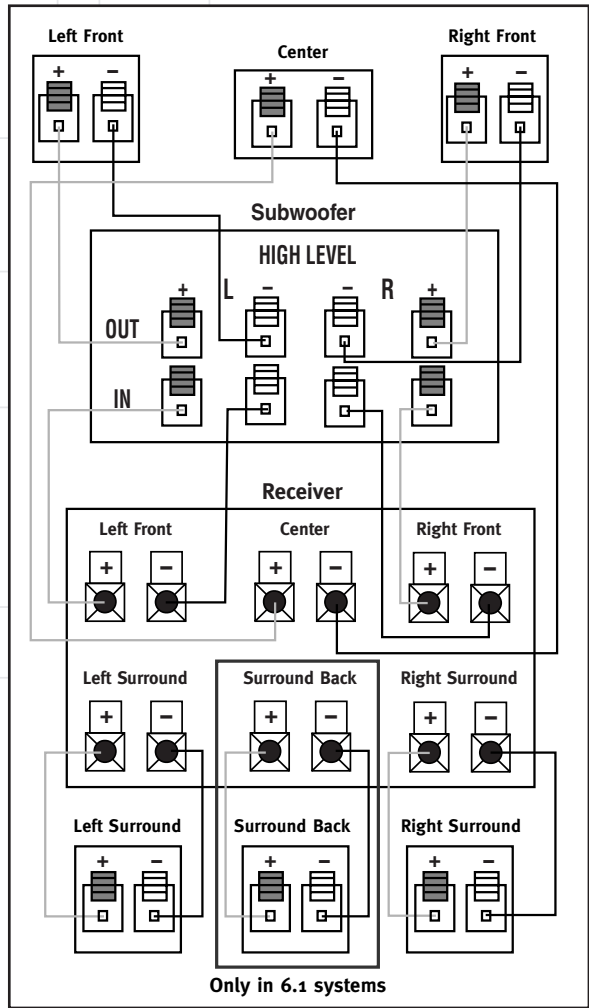

## Dolby Pro Logic (Non-Digital) – Line Level (SCS 140 and SCS 146)

Use this installation method for Dolby Pro Logic applications (not Dolby Digital, DTS® or other digital processing), where the receiver/processor is equipped with a subwoofer

output, or a volume-controlled preamp (line-) level output: Use RCA-type patch cords to connect the line-level subwoofer output on your receiver or to amplifier either

the left or right line-level input on the subwoofer. **IMPORTANT:** Do not use the LFE input on the subwoofer with Dolby Pro Logic processors. Note: If your receiver or amplifier has two subwoofer output jacks then you can plug the RCA-type patch cords into both left and right line-level inputs on the subwoofer. Connect each speaker to the corresponding speaker terminals on your receiver or amplifier.

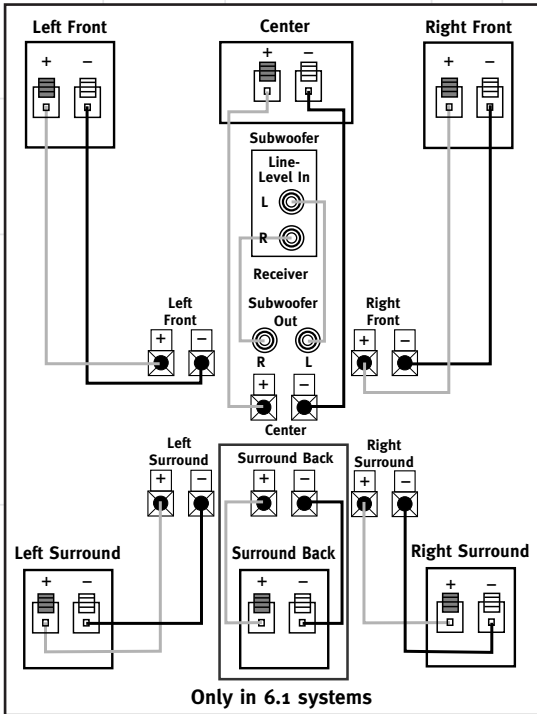

## Dolby Digital or DTS® (or Other Digital Surround Mode) Connection (SCS 140 and SCS 146)

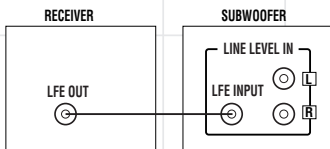

Use this installation method for Dolby Digital, DTS® or other digital surround processors: Use the line-level input jack marked "LFE" for the Low-Frequency Effects channel. Connect this jack to the LFE

output or subwoofer output on your receiver or amplifier. Connect each speaker to the corresponding speaker terminals on your receiver or amplifier.

Make sure that you have configured your surround-sound processor for "Subwoofer On." The surround receiver should be configured for 6.1-channel operation (if available) and the front left, front right, center and

rear speakers should all be set to "Small." If your receiver allows you to set the crossover frequency between the subwoofer and the main speakers, select either 120Hz or 150Hz, or select the setting that is the closest frequency below these.

# OPERATION

Move the Master Power switch (marked "Power" ❶) to the "•" (On) position to use the subwoofer. The SCS 140 subwoofer will automatically turn itself on or go into standby (sleep) mode when left in the standby mode ("Auto/On" switch ❷ in the "Auto" position). When your receiver or amplifier is off, or is not

sending program material to the subwoofer, the subwoofer will be in standby mode. When the subwoofer senses an audio signal, it will automatically turn itself on. If the subwoofer does not sense a signal after approximately twenty minutes, it will automatically go into standby mode.

When the "Auto/On" switch ❷ is switched to the "On" position, the subwoofer will remain on, whether or not program material is playing. If you will be away from home for an extended period of time, or if the subwoofer will not be used, switch the Master Power switch ❶ to the Off position.

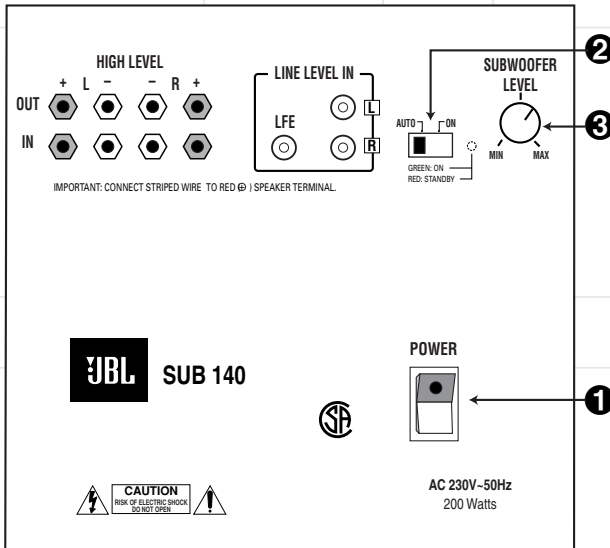

## Volume

Volume can be adjusted using the Subwoofer Level Control ❸ (above), as shown below.

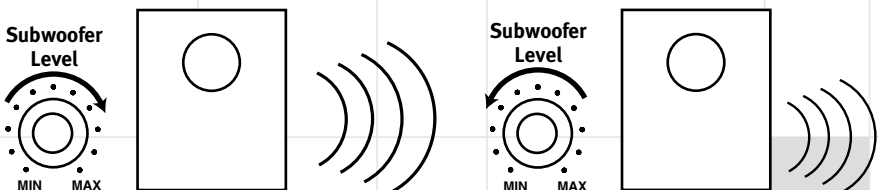



# TROUBLESHOOTING

## **If there is no sound from any of the speakers:**

- Check that receiver/amplifier is on and a source is playing.
- Check that the powered subwoofer is plugged in, its Power switch **I** is switched on to the "ON" position.
- Check all wires and connections between receiver/ amplifier and speakers. Make sure all wires are connected. Make sure none of the speaker wires are frayed, cut or punctured.
- Review proper operation of your receiver/amplifier.

## **If there is no sound coming from one speaker:**

- Check the "Balance" control on your receiver/amplifier.
- Check all wires and connections between receiver/ amplifier and speakers. Make sure all wires are connected. Make sure none of the speaker wires are frayed, cut or punctured.
- In Dolby Digital or DTS® modes, make sure that the receiver/processor is configured so that the speaker in question is enabled.

## **If there is no sound from the center speaker:**

- Check all wires and connections between receiver/ amplifier and speaker. Make sure all wires are connected. Make sure none of the speaker wires are frayed, cut or punctured.

- If your receiver/processor is set in Dolby Pro Logic mode, make sure the center speaker is not in phantom mode.
- If your receiver/processor is set in Dolby Digital or DTS® mode, make sure the receiver/processor is configured so that the center speaker is enabled.

## **If the system plays at low volumes but shuts off as volume is increased:**

- Check all wires and connections between receiver/ amplifier and speakers. Make sure all wires are connected. Make sure none of the speaker wires are frayed, cut or punctured.
- If more than one pair of main speakers is being used, check the minimum impedance requirements of your receiver/amplifier.

## **If there is low (or no) bass output:**

- Make sure the connections to the left and right "Speaker Inputs" have the correct polarity (+ and -).
- Make sure the subwoofer is plugged into an active electrical outlet.
- Make sure the powered subwoofer is plugged in and switched on.
- In Dolby Digital or DTS® modes, make sure your receiver/processor is configured so that the subwoofer and LFE output are enabled.

## **If there is no sound from the surround speakers:**

- Check all wires and connections between receiver/ amplifier and speakers. Make sure all wires are connected. Make sure none of the speaker wires are frayed, cut or punctured.
- Review proper operation of your receiver/amplifier and its surround-sound features.
- Make sure the movie or TV show you are watching is recorded in a surround-sound mode. If it is not, check to see if your receiver/ amplifier has other surround modes you may use.
- In Dolby Digital or DTS® modes, make sure your receiver/processor is configured so that the surround speakers are enabled.
- Review the operation of your DVD player and the jacket of your DVD to make sure that the DVD features the desired Dolby Digital or DTS® mode, and that you have properly selected that mode using both the DVD player's menu and the DVD disc's menu.

# SPECIFICATIONS

## SCS 140/SCS 146 Satellite and SCS 146 Surround Back

Frequency Response (-6dB):	120Hz – 20kHz
Sensitivity (2.83V/1m):	86dB
Nominal Impedance:	4 Ohms
Recommended Amplifier Power	10 – 50 Watts RMS per Channel
Drive Units:	12mm Titanium Laminate Dome Video-shielded HF 75mm Paper Cone Video-shielded Midrange
Dimensions (H x W x D):	111mm x 81mm x 95mm (4.4" x 3.2" x 3.7")
Weight:	0.5kg (1.1lb)

## SCS 140/SCS 146 Center

Frequency Response (-6dB):	120Hz – 20kHz
Sensitivity (2.83V/1m):	88dB
Nominal Impedance:	4 Ohms
Recommended Amplifier Power	10 – 50 Watts RMS per Channel
Drive Units:	12mm Titanium Laminate Dome Video-shielded HF Dual 75mm Paper Cone Video-shielded Midrange
Dimensions (H x W x D):	83mm x 194mm x 95mm (3.3" x 7.6" x 3.7")
Weight:	0.85kg (1.88lb)

## SCS 140 Active Subwoofer

Low Frequency Cut-off:	35Hz
High Frequency Cut-off:	160Hz
Built-in Power Amplifier:	100 Watts RMS
Drive Unit:	200mm Paper Cone Long Throw Driver. Bass Reflex Enclosure
Dimensions (H x W x D):	410mm x 280mm x 376mm
Weight:	12.7kg

## SCS 140/SCS 146 System

Frequency Response (-6dB):	35Hz – 20kHz
----------------------------	--------------

Refinements may be made on occasion to existing products without notice, but will always meet or exceed original specifications unless otherwise stated.

Simply Cinema is a registered trademark of JBL, Incorporated.

\*Dolby and Pro Logic are trademarks of Dolby Laboratories.

DTs® is a registered trademark of Digital Theater Systems, Inc.

## OWNER'S GUIDE

PRODUCT LINE:

*Simply Cinema*

MODEL NUMBER:

**SCS 140, SCS 146, DSC 1000 (230V)**

**DESIGN GOAL:** Bring the thrill of live performance and movie sound to the home environment by calling on JBL's professional engineering leadership.

**SATELLITE TYPE:** Titanium-laminate-dome tweeter, sealed enclosure

**SUBWOOFER TYPE:** Bass-reflex enclosure

**PORT DESIGN:** FreeFlow™ flared

**PROFESSIONAL REFERENCE:** Cinema Loudspeaker Series

**JBL**

**PRO SOUND  
COMES HOME™**

JBL Consumer Products  
250 Crossways Park Drive, Woodbury, NY 11797  
Europe: 2, Route de Tours, 72500 Château du Loir, France

[www.jbl.com](http://www.jbl.com)

©2003 JBL, Incorporated.

JBL is a registered trademark of JBL, Incorporated.

Part No. 406-000-00969 

 A Harman International Company

## Free Manuals Download Website

<http://myh66.com>

<http://usermanuals.us>

<http://www.somanuals.com>

<http://www.4manuals.cc>

<http://www.manual-lib.com>

<http://www.404manual.com>

<http://www.luxmanual.com>

<http://aubethermostatmanual.com>

Golf course search by state

<http://golfingnear.com>

Email search by domain

<http://emailbydomain.com>

Auto manuals search

<http://auto.somanuals.com>

TV manuals search

<http://tv.somanuals.com>