

VRX900
S E R I E S

User's Guide

V R X 9 3 2 L A P

V R X 9 1 8 S P

V R X - A F



CONTENTS

Section 1. Safety Instructions	4
JBL DrivePack® Declaration of Conformity	6
Section 2. Before You Begin	7
Section 3. Introduction to The VRX932LAP	8
Section 4. Introduction to The VRX918SP	10
Section 5. JBL DrivePack® Technology	12
VRX932LAP Input Panel	15
VRX918SP Input Panel	17
Amplitude Shading	19
Section 6. Deploying The System	21
Section 7. Suspension Safety Warnings!	23
Section 8. Introduction to The VRX-AF	26
JBL Warranty and Information	27

PATENTS

VRX series products are manufactured and sold under U.S. patents 5,748,760; 6,112,847; 6,394,223; 6,847,726; 6,774,510; D483,743; and 6,768,806.

SECTION 1. SAFETY INSTRUCTIONS

IMPORTANT SAFETY INSTRUCTIONS

1. Read these instructions.
2. Keep these instructions.
3. Heed all warnings.
4. Follow all instructions.
5. Do not use this apparatus near water.
6. Clean only with dry cloth.
7. Do not block any ventilation openings. Install in accordance with the manufacturer's instructions.
8. Do not install near any heat sources such as radiators, heat registers, stoves, or other apparatus (including amplifiers) that produce heat.
9. Do not defeat the safety purpose of the polarized or grounding-type plug. A polarized plug has two blades with one wider than the other. A grounding-type plug has two blades and a third grounding prong. The wide blade or the third prong are provided for your safety. If the provided plug does not fit into your outlet, consult an electrician for replacement of the obsolete outlet.
10. Protect the power cord from being walked on or pinched, particularly at plugs, convenience receptacles, and the point where they exit from the apparatus.
11. Only use attachments/accessories specified by the manufacturer.
12. Use only with the cart, stand, tripod, bracket, or table specified by the manufacturer, or sold with the apparatus. When a cart is used, use caution when moving the cart/ apparatus combination to avoid injury from tip-over. 
13. Unplug this apparatus during lightning storms or when unused for long periods of time.
14. Refer all servicing to qualified service personnel. Servicing is required when the apparatus has been damaged in any way, such as power supply cord or plug is damaged, liquid has been spilled or objects have fallen into the apparatus, the apparatus has been exposed to rain or moisture, does not operate normally, or has been dropped.
15. **WARNING:** To reduce the risk of fire or electric shock, do not expose this apparatus to rain or moisture.
16. Do not expose this equipment to dripping or splashing and ensure that no objects filled with liquids, such as vases, are placed on the equipment.
17. To completely disconnect this apparatus from the AC Mains, disconnect the power supply cord plug from the AC receptacle.
18. The mains plug of the power supply cord shall remain readily operable.



THIS APPARATUS CONTAINS POTENTIALLY LETHAL VOLTAGES. TO PREVENT ELECTRIC SHOCK OR HAZARD, DO NOT REMOVE DRIVEPACK CHASSIS, INPUT MODULE OR AC INPUT COVERS. NO USER SERVICEABLE PARTS INSIDE. REFER SERVICING TO QUALIFIED SERVICE PERSONNEL.

WATCH FOR THESE SYMBOLS



The lightning bolt triangle is used to alert the user to the risk of electric shock.



The exclamation point triangle is used to alert the user to important operating or maintenance instructions.

FCC COMPLIANCE NOTICE

This device complies with part 15 of the FCC rules. Operation is subject to the following two conditions: (1) This device may not cause harmful interference, and (2) this device must accept any interference received, including interference that may cause undesired operation.

CAUTION: Changes or modifications not expressly approved by the party responsible for compliance could void the user's authority to operate the equipment.

CSA COMPLIANCE NOTICE

CSA Certification Applies to Amplifier Module.

JBL DRIVEPACK® DECLARATION OF CONFORMITY

SAFETY AND EMC COMPLIANCE SPECIFICATIONS

EN 55103-1:1997	Electromagnetic Compatibility - Product Family Standard for Audio, Video, Audio-Visual and Entertainment Lighting Control Apparatus for Professional Use, Part 1: Emissions
EN 55103-1:1997	Magnetic Field Emissions-Annex A @ 10 cm and 1 M
EN 55022:2003	Limits and Methods of Measurement of Radio Disturbance Characteristics of ITE: Radiated, Class B Limits; Conducted, Class A
EN 55103-2:1997	Electromagnetic Compatibility - Product Family Standard for Audio, Video, Audio-Visual and Entertainment Lighting Control Apparatus for Professional Use, Part 2: Immunity
EN 61000-4-2: A2:2001	Electrostatic Discharge Immunity (Environment E2-criteria B, 4 kV Contact, 8 kV Air discharge)
EN 61000-4-3:2003	Radiated, Radio-frequency, Electromagnetic Immunity (Environment E2, criteria A)
EN61000-4-4:2005	Electrical Fast Transient/Burst Immunity (criteria B)
EN 61000-4-5:2001	Surge Immunity (criteria B)
EN 61000-4-6:1996	Immunity to Conducted Disturbances Induced by Radio-Frequency Fields (criteria A)
EN 61000-4-11:2004	Voltage Dips, Short Interruptions and Voltage Variation
UL 6500 2nd Edition 1999	Audio/Video and Musical Instrument Apparatus for Household, Commercial and Similar General Use
CAN/CSA E60065-00	Audio, Video and Similar Electronic Apparatus - Safety Requirements

SECTION 2 : BEFORE YOU BEGIN

The VRX Series loudspeakers covered by this manual are not intended for fixed installation in outdoor or high moisture environments. Moisture can damage the speaker cone and surround and cause corrosion of electrical contacts and metal parts. Avoid exposing the speakers to direct moisture. Keep loudspeakers out of extended or intense direct sunlight. The driver suspension will prematurely dry out and finished surfaces may be degraded by long-term exposure to intense ultra-violet (UV) light.

The VRX Series loudspeakers can generate considerable energy. When placed on a slippery surface such as polished wood or linoleum, the speaker may move due to its acoustical energy output. Precautions should be taken to assure that the speaker does not fall off a stage or table on which it is placed.

Make sure the selected AC line voltage is correct.

STAND MOUNTING SAFETY PRECAUTIONS

Some VRX Series models can be used with an optional stand mount accessory allowing mounting on tripod stands or on a pole over subwoofers. When using stands or poles, be sure to observe the following precautions:

- Check the stand or pole specification to be certain the device is designed to support the weight of the speaker. Observe all safety precautions specified by the manufacturer.
- Always verify that the stand (or subwoofer / pole) is placed on a flat, level, and stable surface and be sure to fully extend the legs of tripod type stands. Position the stand so that the legs do not present a trip hazard.
- Route cables so that performers, production crew, and audience will not trip over them and pull the speaker over.
- Inspect the stand (or pole and associated hardware) before each use and do not use equipment with worn, damaged, or missing parts.
- Do not attempt to place more than two VRX932LAP Series loudspeaker on a stand or pole.
- Always be cautious in windy, outdoor conditions. It may be necessary to place additional weight (i.e. sandbags) on the base of the stand to improve stability. Avoid attaching banners or similar items to any part of a speaker system. Such attachments could act as a sail and topple the system.
- Unless you are confident that you can handle the weight of the speaker, ask another person to help you get it onto the tripod stand or pole.

HEARING DAMAGE, PROLONGED EXPOSURE TO EXCESSIVE SPL

VRX Series loudspeakers are easily capable of generating sound pressure levels (SPL) sufficient to cause permanent hearing damage to performers, production crew and audience members. Caution should be taken to avoid prolonged exposure to SPL in excess of 90 dB.

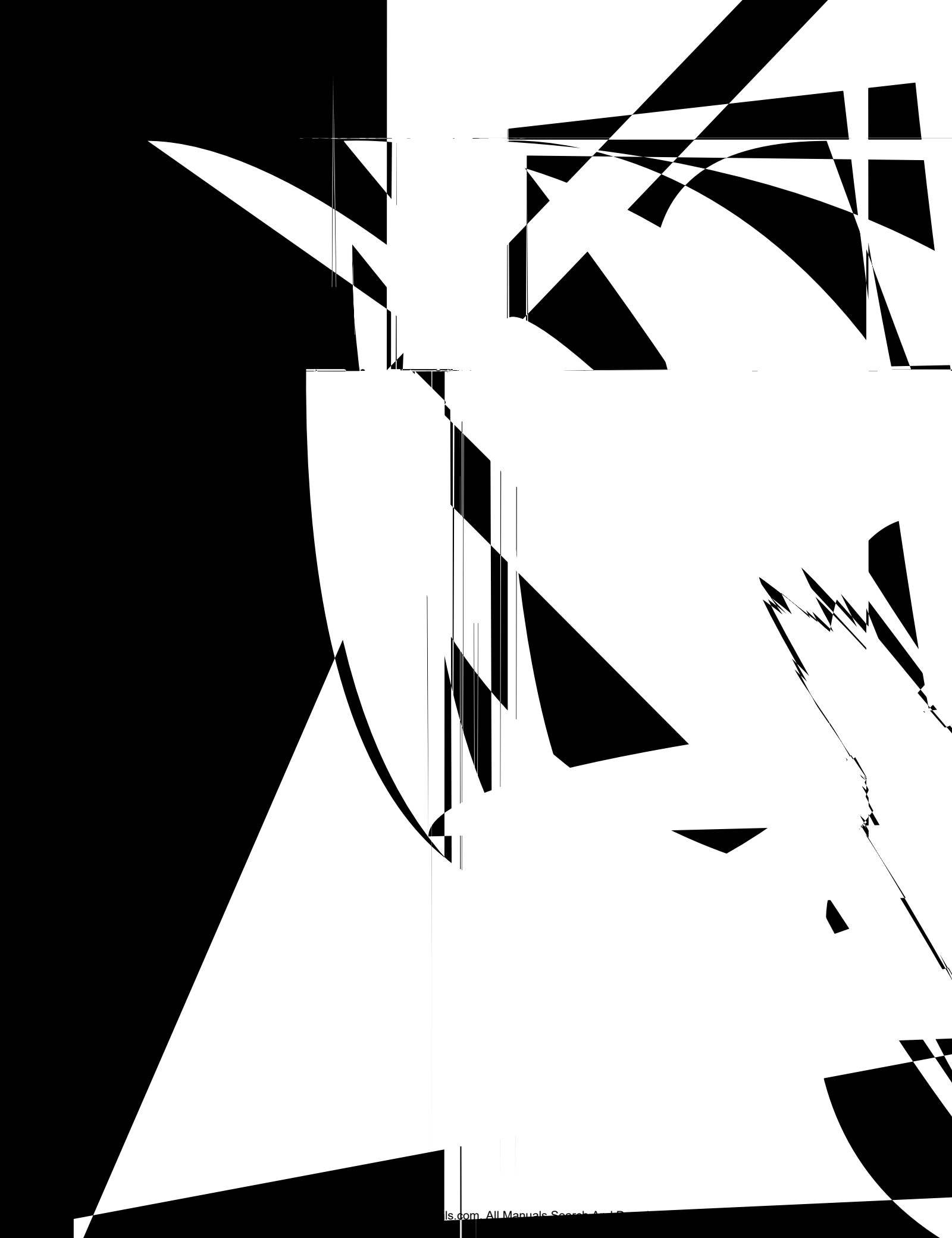

VRX932LAP - 12", POWERED TWO-WAY, LINE-ARRAY LOUDSPEAKER SYSTEM

Frequency Range (-10 dB):	57 Hz - 20 kHz
Frequency Response (± 3 dB):	75 Hz - 20 kHz
Coverage Pattern:	100° x 15° nominal
Maximum Peak Output, SPL ¹	136 dB SPL at 1m
LF Driver:	1 x JBL 2262FF 305 mm (12 in) dual voice coil Differential Drive® woofer with neodymium-magnet
HF Driver:	3 x JBL 2408J, 34 mm (1.5 in) voice coil, neodymium compression driver
Bandpass Nominal Impedance:	LF: 2 x 2 ohms HF: 4 ohms
DPC-2 Internal Amplification Output (at nominal load):	1750 Watts Peak, 875 Watts Continuous
DPC-2 Output (Continuous IEC shaped pink noise into rated load impedance):	LF: 750 Watts, HF: 125 Watts
DPC-2 Output Section:	LF: Dual Bridged Technology™, Class D HF: Bridged Class D
Audio Input Connector:	XLR with loop through
User Controls:	Input Attenuator (0-16 dB) ACS (Array Configuration Selector) HF level adjustment (+3 dB, 0 dB, -3dB)
Signal Processing:	DSP based, resident in Input Module
System Management:	DSP based limiters for mechanical and thermal protection.
AC Power Operating Range:	90-132 VAC or 216-264 VAC, 50/60Hz
AC Line Voltage:	User selectable: 120V/240V (-15%, +10%)
AC Input Connector:	Neutrik PowerCon® (NAC 3MPA)
AC Loop Through Connector:	Neutrik PowerCon® (NAC 3MPB)
AC Current Requirements:	6A per system at 120V, 3A per system at 240V
Enclosure:	25/15 mm, birch plywood.
Suspension / Mounting:	Optional VRX-AF line-array frame kit, 10mm forged eyebolts or internal dual angle 36mm pole mount cup for pole or tripod mounting
Finish:	Black DuraFlex™ finish
Grille:	Powder coated, black, 16-gauge perforated steel with acoustically transparent foam
Dimensions (H x W x D):	349 mm x 597 mm x 444 mm (13.75 in x 23.5 in x 17.5 in)
Net Weight:	24 kg (52 lb)
Optional Accessories:	VRX-AF array frame SS2-BK tripod speaker stand SS3-BK satellite speaker pole SS4-BK adjustable satellite speaker pole to be used with the VRX918S/SP and SRX718S only.

¹ Maximum Peak output measured with IEC pink noise at 1 meter in front of speaker baffle under free space conditions. Measurement instrument set to peak hold. Speaker muted and released at full power, recording maximum peak level.

FUNCTIONAL BLOCK DIAGRAM

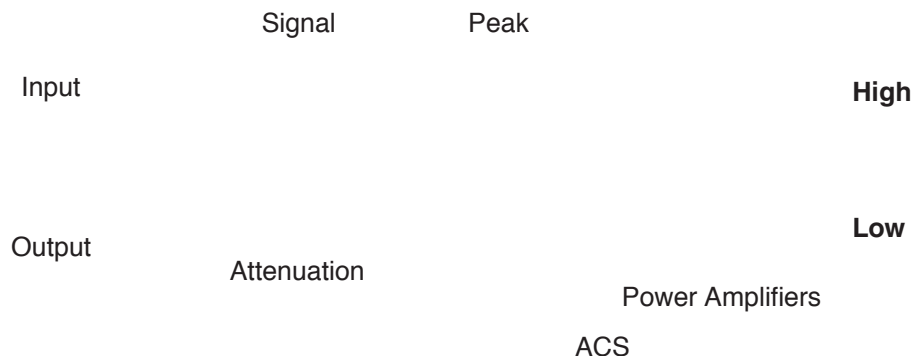

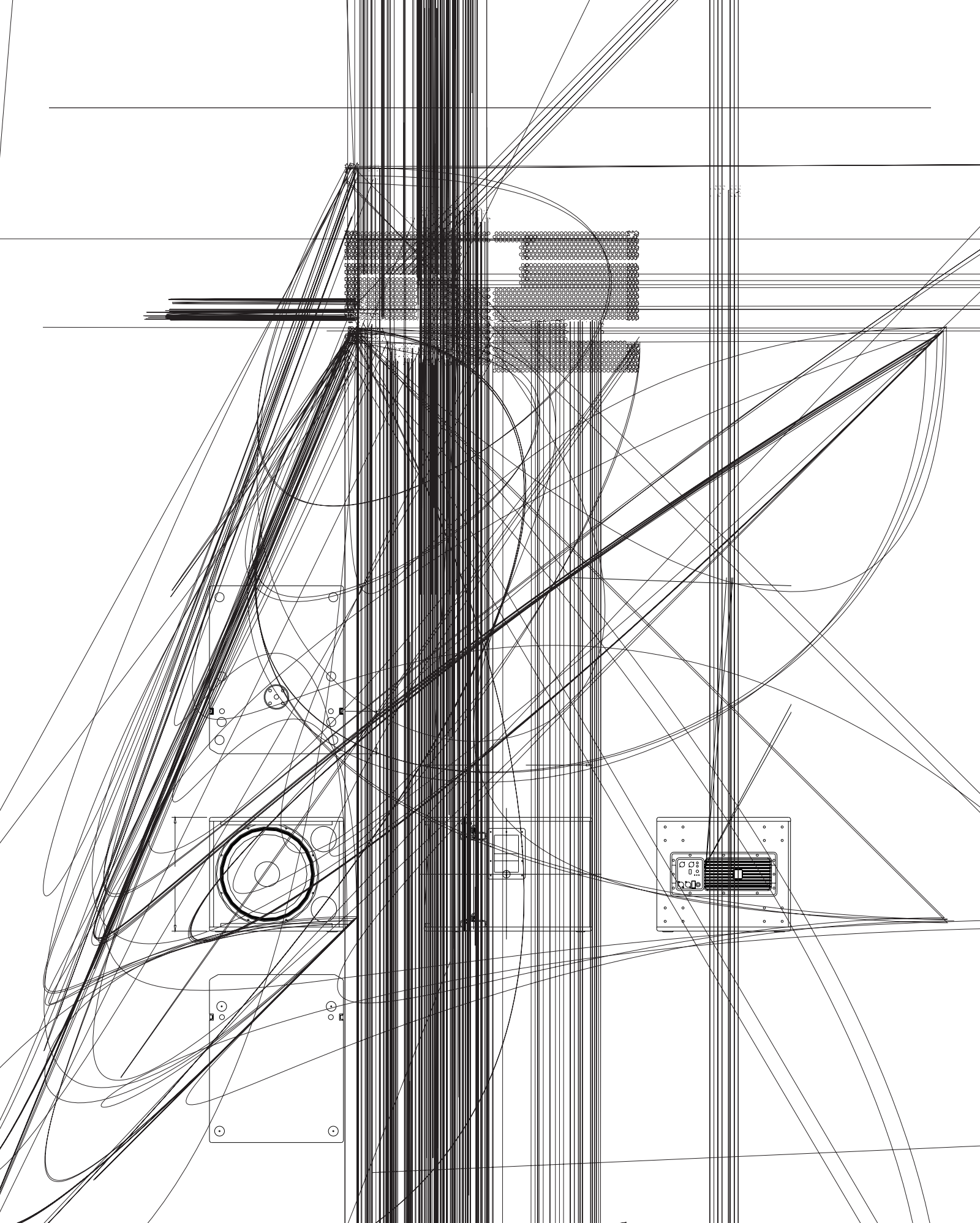

VRX918SP - 18" POWERED SUBWOOFER

Frequency Range (-10 dB):	31 Hz - 180 Hz
Frequency Response (± 3 dB):	34 Hz - 120 Hz
Maximum Peak Output, SPL1:	126 dB SPL at 1m
LF Driver:	1 x JBL 2268FF 457 mm (18 in) dual voice coil Differential Drive® woofer with neodymium-magnet
Bandpass Nominal Impedance:	LF: 2 x 2 ohms
DPC-2 Internal Amplification Output (at nominal load):	1500 Watts Peak, 750 Watts Continuous
DPC-2 Output as (Continuous IEC shaped pink noise into rated load impedance):	LF: 750 Watts
DPC-2 Output Section:	LF: Dual Bridged Technology™, Class D
Audio Input Connector:	XLR with loop through
User Controls:	Input Attenuator (0-16 dB) Selectable 80Hz or 120Hz Low Pass 80Hz High-Pass enable/ disable for XLR loop through
Signal Processing:	DSP based, resident in Input Module
System Management:	DSP based limiters for mechanical and thermal protection
AC Power Operating Range:	90-132 VAC or 216-264 VAC, 50/60Hz
AC Line Voltage:	User selectable: 120V/240V (-15% +10%)
AC Input Connector:	Neutrik PowerCon (NAC 3MPA)
AC Loop Through Connector:	Neutrik PowerCon (NAC 3MPB)
AC Current Requirements:	6A per system at 120V, 3A per system at 240V
Enclosure:	18 mm, birch plywood.
Suspension / Mounting:	Optional VRX-AF line-array frame kit or 10mm forged eyebolts
Finish:	Black DuraFlex™ finish
Grille:	Powder coated, black, 16-gauge perforated steel with acoustically transparent foam
Dimensions (H x W x D):	508 mm x 597 mm x 749 mm (20.0 in x 23.5 in x 29.5 in)
Net Weight:	38.5 kg (85 lb)
Optional Accessories:	VRX-AF array frame SRX718S-CVR: Pull-over padded cover (works with WK-4S) SS4-BK adjustable satellite speaker pole WK-4S Caster kit

¹ Maximum Peak output measured with IEC pink noise at 1 meter in front of speaker baffle under free space conditions. Measurement instrument set to peak hold. Speaker muted and released at full power, recording maximum peak level.

FUNCTIONAL BLOCK DIAGRAM

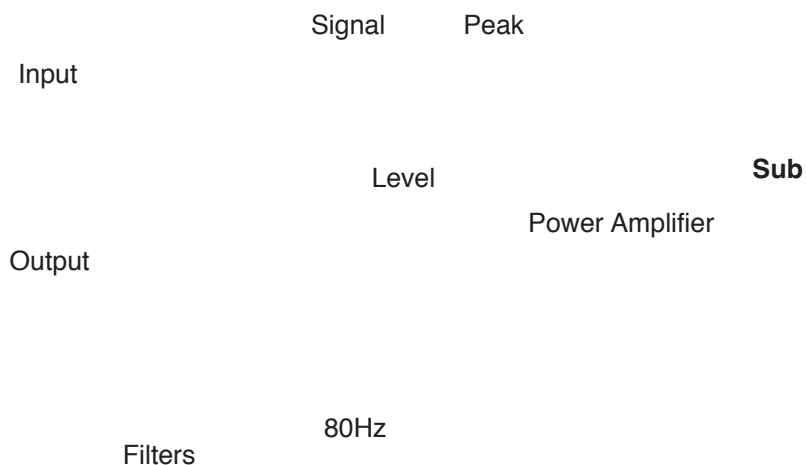

SECTION 5 : JBL DRIVEPACK® TECHNOLOGY

INTRODUCTION TO THE JBL DRIVEPACK® DPC-2 INTEGRATED AUDIO SYSTEM

JBL DrivePack equipped loudspeakers are a family of fully integrated audio systems, coupling industry-leading loudspeaker technology to a combination of comprehensive digital signal processing and advanced amplifier technology, perfectly matched to the enclosures to deliver superb audio quality and powerful performance. Designed in cooperation with Crown International, the DCP-2 features Dual Bridged Technology™. Each discrete amplifier channel is linked to one voice coil of the Differential Drive loudspeaker. Electrical power transfer to the transducer is optimized for maximum system performance. The DrivePack includes onboard DSP functionality and displays lighted system status indicators during operation.

DRIVEPACK SIGNAL-PROCESSING & AMPLIFICATION UNIT



The DrivePack electronics unit is intended to be used when mounted to a speaker enclosure of 5/8" minimum thickness of wood or composite material and with load impedances of 2 to 4 Ohms for low and mid frequency channels, and 4 to 16 Ohms for the high frequency channel.

OPERATING INSTRUCTIONS

All that is required to get your DP compatible loudspeaker system up and running is to verify that the main panel voltage select switch setting is appropriate for the power in your area, connect an AC power source to the AC Power panel via the Neutrik twist-lock PowerCon® inlet connector, and connect a full range line level audio signal to the Input panel via the AUDIO IN XLR connector.

The JBL DPC-2 is equipped with a manual select 115V/230V Power Supply and can operate anywhere in the world that has an available 100-120VAC or 200-240VAC power source. Upon initial power-up of the DrivePack, the AC soft-start process will begin and the Blue Power LED illuminates when boot-up is completed.

AMPLIFIER PROTECTION FEATURES

THERMAL MANAGEMENT:

JBL DrivePack systems are cooled by Passive Convection. No fans are used in any part of the thermal management system. To maintain efficient cooling it is a good practice to assure open space around the DrivePack units. In the event of excessive exposure to direct sunlight in very hot ambient conditions, it is possible that the unit may overheat and will automatically shut down to protect itself. When its internal temperature has returned to within its operating range it will turn back on. To prevent overheating: ensure adequate cooling and avoid direct exposure of the amplifier panel to direct sunlight by shading it.

OPERATING TEMPERATURE:

The system will remain touchable during quiescent operation and will not provide a burn hazard during any operating condition.

AC POWER REQUIREMENTS

JBL DrivePack DPC-2 systems are equipped with a DPC-2 multi-channel Dual-Bridged Technology™ power amplifier and loudspeaker specific DSP electronics. The system requires appropriate AC power.



CAUTION:

In compliance with safety agency criteria and proper system operation, it is critical that the system installer observe all electrical safety practices at all times and provide proper earth grounding for all AC Power connections.

AC POWER CORD KIT

120VAC North America NEMA 5-15 Edison type AC plug to PowerCon® connector and 240V Europe CEE 7/7 Schuko type AC plug to PowerCon connector cord sets are provided with this JBL DrivePack product.

One spare gray Neutrik (P/N NAC3FCB) PowerCon connector is included in the AC Power Cord Set for your convenience to create a pass-through AC power cable. To create a light-duty pass-through cable the system installer may choose to simply cut off the AC plug from one of the provided AC cord sets and replace it with the provided Gray PowerCon AC Outlet connector. Follow the wiring convention indicated in Table 1.

NOTE: Tighten set screws to 2.5Nm (1.8lb-ft) torque to prevent opening by hand.



CAUTION:

In compliance with safety agency criteria and proper system operation, it is critical that the system installer observe all electrical safety practices at all times and provide proper earth grounding for all AC Power connections.

USER-FABRICATED AC POWER DISTRIBUTION

System owners may choose to fabricate or purchase a custom AC Power cable infrastructure optimized for their specific JBL DrivePack system configuration. See Table 1 for custom application wiring and connector information.

NOTE: Parts not provided.



CAUTION:

Do not exceed 80% current rating of any AC connector at any time! See AC Power Rating Table for current draw information.

Table 1. User-Fabricated AC Cable and Connector Information

AC Inlet Cable Connector	Neutrik PowerCon® NAC3FCA quick lock 3-pole A-type cable connector for power inlet. Rated current per contact: 20 A (rms), Rated Voltage: 250VAC.
AC Outlet Cable Connector	Neutrik PowerCon® NAC3FCB quick lock 3-pole B-type cable connector for power outlet. Rated current per contact: 20 A (rms), Rated Voltage: 250VAC.
Wiring	Cable: screw-type terminals or soldering nom. wire size/contact: 2.5 mm ² / 16 AWG
Wiring convention	Ground -Ground, Neutral - Neutral, AC Hot - AC Hot
With the two non-interchangeable types of connectors (A-type, B-type) it is impossible to produce a short circuit. Mating connectors (combination) are identified by mechanical keyways and by color.	

Table 2. Power Connector Coding

A-type (POWER INLET)	Cable connector: Blue
B-type (POWER OUTLET)	Cable connector: Gray, with Blue bushing

DPC-2 AC POWER RATINGS

Description	115VAC	230VAC	
Quiescent Power Draw	30W	30W	
1/8th Power, Pink Noise (UL/CSA)	85W, 1.5A rms	85W, 1.5A rms	
1/3rd Power, Pink Noise	2 A	1 A	
Maximum Power Draw	1440W	1440W	
Inrush Current	Inrush current limiting via PTC soft-start		
AC Power Module Connectors:	12A Max, 100-120VAC/220-240VAC, 50-60 Hz. Class 1 Wiring		16 AWG (1.5 mm ²)
Inlet Connector Rating	5A	3A	
Outlet Connector Rating	7A	9A	

Line Voltage Selection: DrivePack DPC-2 amplifier models feature a user-configurable dual-voltage international power supply and is easily set to the appropriate local AC Power Mains voltage supply. A 2-way slide switch is provided to select 100-120VAC or 200-240VAC operation, 50/60Hz.

Before you set up your VRX900 Powered series speaker for the first time, verify that the line voltage selector setting is appropriate for the AC Mains supply voltage in your area. Applying 230 VAC to the DPC-2 with the unit set to 115V can cause serious damage.

CHANGING THE AC MAINS SUPPLY VOLTAGE SETTING

- Make sure that the speaker is powered off and the AC power cable is disconnected from the speaker.
- Locate the voltage selector switch next to the blue PowerCon connector on the main control panel.
- Slide the voltage selector switch to 115V for (100-120V~) or 230V for (220-240V~) range setting as required for your area.
- After having reconfirmed that the correct voltage is selected, reconnect the blue AC Line Input PowerCon connector and power the unit up.

DO NOT UNDER ANY CIRCUMSTANCES OPERATE THE UNIT WITH THE WRONG VOLTAGE SELECTED. DOING SO MAY RESULT IN SERIOUS DAMAGE TO YOUR SPEAKER SYSTEM WHICH WILL NOT BE COVERED BY WARRANTY.

Line Voltage Tolerance: The amp will operate normally (with expected de-rating in power output during low line conditions) over a range of 100-120VAC +/-10% or 200-240VAC +/-10% AC input voltage. The amp will shut down for voltages below nominal line and self protect for over-voltage beyond 15% nominal line.



CAUTION:

Continuous voltages 10% beyond high line at either 120VAC or 240VAC operation ranges can disrupt performance of the JBL DrivePack! To avoid activation of amplifier low line/high line protection which will interrupt audio performance, the system operator should maintain AC supply voltages within the rated voltage windows.

VRX932LAP INPUT PANEL

The VRX932LAP input panel features analog audio inputs and sophisticated onboard digital signal processing technology. Precision Bandpass limiting, pre-equalization filters and automatic self-protection functions ensure maximum performance. JBL engineers have calibrated the DSP speaker management and limiter parameters to ensure smooth phase response and transfer function.

CONTROLS

1.& 2. HF OUTPUT LEVEL (ACS)

Push-button DSP preset selection switches for Amplitude Shading (ACS) and for adjusting tonal balance for different system configurations. When set in the -3dB position, the High Frequency level is reduced by -3dB from nominal. This selection is recommended if only a single speaker is employed.

See the ACS section (page 19 & 20) for more information.

3. ATTENUATION

Detented rotary input sensitivity control attenuates level in 0.5 dB steps. The Input Sensitivity is +4 dBu nominal (+20 dBu clip) with the control fully counterclockwise, and -10 dBV nominal (+4 dBu clip) with the control fully clockwise.

(Note: Professional mixing boards with XLR outputs should use the fully counterclockwise position as start ing point. Whereas semi-professional equipment with 1/4 inch jack's, RCA connectors and unbalanced sources should start at the middle position - watch for clipping (peak LED)!

4. RESET

Press to reset line voltage circuit breaker.

5. LINE SELECT

Two-position slide switch, set to 115V position for (100-120V~) or 230V position for (220-240V~) operation.

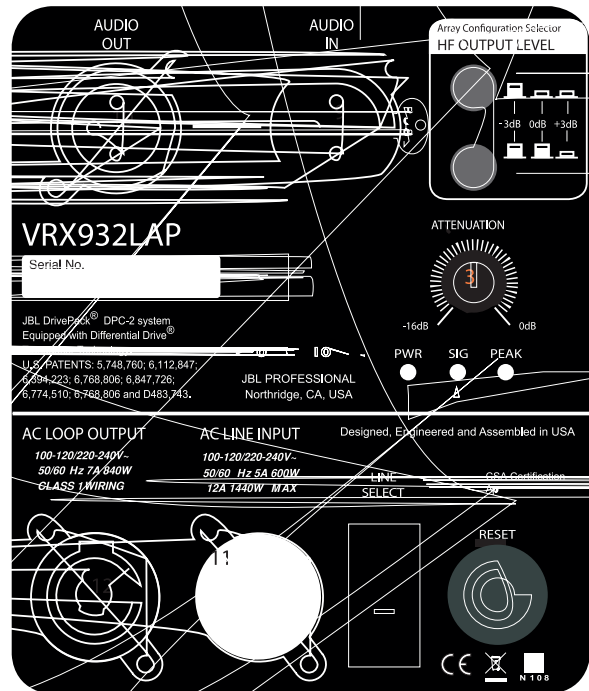

INDICATORS

6. PEAK

Red LED, detects excessive input signal. Reduce the input level if this LED lights excessively. The LED illuminates when overload is detected.

7. SIG

Green LED, detects input signal, illuminates above the threshold set at -70 dBu.

8. POWER

Blue LED - located near voltage select switch, illuminates when AC power is applied and unit is ready for operation.

CONNECTORS

9. Audio In

F-XLR Active 20K Ohm Balanced, 10K Ohm Unbalanced. Pin 2 Hot (Positive voltage produces outward cone motion of L.F. Transducers).

10. Audio Out

M-XLR Passive Audio Pass-through. Pin 2 Hot (Positive voltage produces outward cone motion of L.F. Transducers).

11. AC LINE INPUT

Blue Neutrik PowerCon® NAC3MPA A-type airtight twist-lock chassis connector for AC power inlet. The mating blue cable connector is keyed and will insert in only one orientation. Electrical connection is made when the AC plug is fully inserted and twisted clockwise until locked into position.

12. LOOP OUTPUT

Gray Neutrik PowerCon NAC3MPB B-type air tight twist-lock power outlet connector is provided to loop AC power through to additional units. The mating gray outlet cable connector is keyed and will insert in only one orientation. Electrical connection is made upon fully inserting the AC plug and twisting clockwise until locked into position. To accomplish loop-thru AC power connections, simply attach a PowerCon jumper cable from the gray connector of the first loudspeaker system to the blue connector of the second, etc. Blue Inlet and Gray Outlet connectors are not interchangeable.



CAUTION:

Looping more than three DPC-2 systems together is not recommended! Do not exceed 80% current rating of any AC connector at any time! Refer to AC Power Rating Tables in this document for current draw information.

The VRX918SP input panel features analog audio inputs and sophisticated onboard digital signal processing technology. Precision Bandpass limiting and automatic self-protection functions ensure maximum performance.

CONTROLS

1. AUDIO OUT

Two-position push-button DSP preset selection switch, enables an 80Hz Hi-Pass filter (graph 1) or direct loop through (graph 2) to the audio output. When set to the "Hi-Pass 80Hz" position, the signal leading to the AUDIO OUT connector is shaped in such a way (graph 1) that allows a smooth transition to a connected full range speaker, crossed over at 80Hz.

(The Hi-Pass frequency is fixed at 80Hz)

When connecting to a second VRX918SP sub woofer set the switch of the first subwoofer to bypass and the last subwoofer to Hi-Pass, so that the last subwoofer in the signal chain provides the xover to the full range system.

2. SUB WOOFER LO-PASS

Two-position push button DSP preset selection switch, engages either an 80Hz or 120Hz Lo-Pass filter (graph 3). The default 80Hz position is recommended. The 120Hz Lo-Pass filter option becomes useful when external signal processing is used or if the low frequency extension of the companion full range system does not reach 80Hz

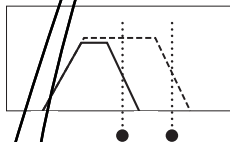

3. ATTENUATION

Detented rotary input sensitivity control attenuates level in 0.5 dB steps. The Input Sensitivity is +4 dBV nominal (+20 dBV clip) with the control fully counter clockwise, and -10 dBV nominal (+4 dBV clip) with the control fully clockwise. (Note: Professional mixing boards with XLR outputs should use the fully counter-clockwise position as a starting point. Whereas semi-professional equipment with 1.4 inch jack's, RCA connectors and unbalanced sources should start at the middle position - watch for clipping (peak LED)!

4. RESET

Press to reset line voltage circuit breaker.

5. LINE SELECT

Two-position slide switch, set to 115V position for (100-120V~) or 230V position for (220-240V~) operation.

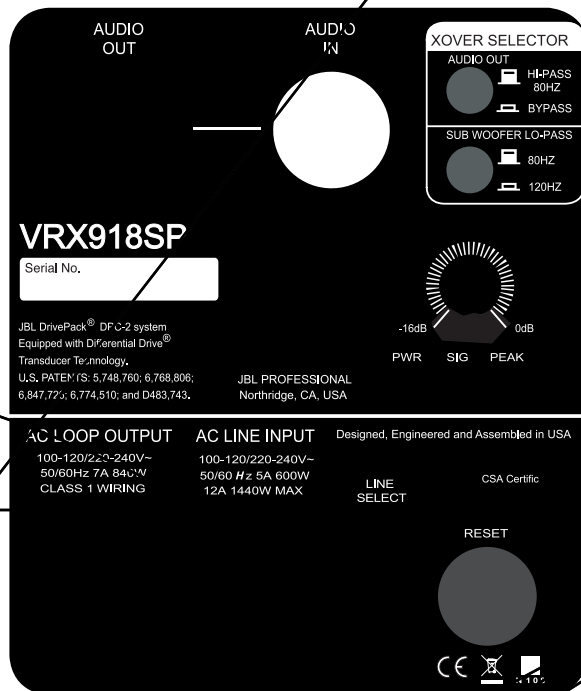

INDICATORS

6. PEAK

Red LED, detects excessive input signal. The LED illuminates when overload at any point is detected.

7. SIG

Green LED, detects input signal, illuminates above the threshold set at -70 dBu.

8. POWER

Blue LED - located near voltage select switch, illuminates when AC power is applied and unit is ready for operation.

CONNECTORS

9. Audio In

F-XLR Active 20K Ohm Balanced, 10K Ohm Unbalanced.

Pin 2 Hot (Positive voltage produces outward cone motion of L.F. Transducers).

10. Audio Out

M-XLR Passive Audio Pass-through.

Pin 2 Hot (Positive voltage produces outward cone motion of L.F. Transducers).

11. AC LINE INPUT

Blue Neutrik PowerCon® NAC3MPA A-type air tight twist-lock chassis connector for AC power inlet. The mating blue cable connector is keyed and will insert in only one orientation. Electrical connection is made when the AC plug is fully inserted and twisted clockwise until locked into position.

12. AC LOOP OUTPUT

Gray Neutrik PowerCon NAC3MPB B-type air tight twist-lock power outlet connector is provided to loop AC power through to additional units.

The mating gray outlet cable connector is keyed and will insert in only one orientation. Electrical connection is made upon fully inserting the AC plug and twisting clockwise until locked into position.

To accomplish loop-thru AC power connections, simply attach a PowerCon jumper cable from the gray connector of the first loudspeaker system to the blue connector of the second, etc. Blue Inlet and Gray Outlet connectors are not interchangeable.



CAUTION:

Looping more than three DPC-2 systems together is not recommended! Do not exceed 80% current rating of any AC connector at any time! Refer to AC Power Rating Tables in this document for current draw information.

AUDIO SIGNAL DISTRIBUTION

Connecting source audio signals to the input modules on JBL DrivePack systems is similar to daisy-chaining multiple external amplifier channels together.

Assuming an output device source impedance of 100 Ohms and a 10:1 load to source ratio, up to 20 JBL DrivePack units typical can be linked together on one output source without using a distribution amp.

AMPLITUDE SHADING

AMPLITUDE SHADING

Amplitude shading is a technique that allows the coverage pattern of a loudspeaker array to be shaped by adjusting the relative acoustic output of some of the devices in the array. Most often, array shading involves only the mid and high-frequency sections of the array. In a simple system consisting of three VRX932LAPs, the lower speaker (which covers the nearest listeners) may have its high-frequency output reduced. At the same time, the upper speaker may have its high frequency output increased. The overall sound-power in the room is unchanged but the distribution of acoustic energy to the audience is far more uniform.

ARRAY CONFIGURATION SELECTOR (ACS)

The -3 dB position will typically be used for the speaker(s) in an array that are covering the nearest listening area. The +3 dB position will be used for the speaker(s) covering the more distant areas; or to compensate for the low-frequency build-up resulting from mutual coupling of multiple woofers in an array. (For the 0dB position the inverse button selection yields to the same results).

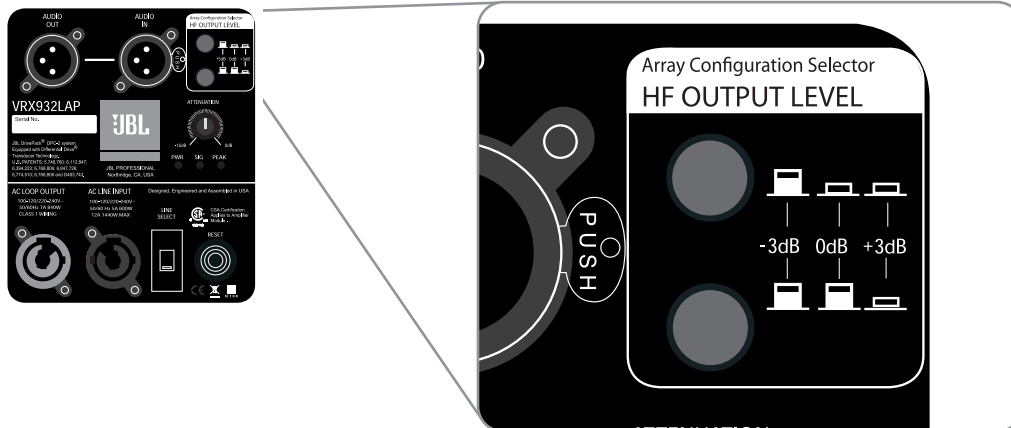

FREQUENCY RESPONSE

The frequency response graph represents measurements from a single typical VRX932LAP speaker, applying the three different ACS settings: +3dB, 0dB, -3dB.

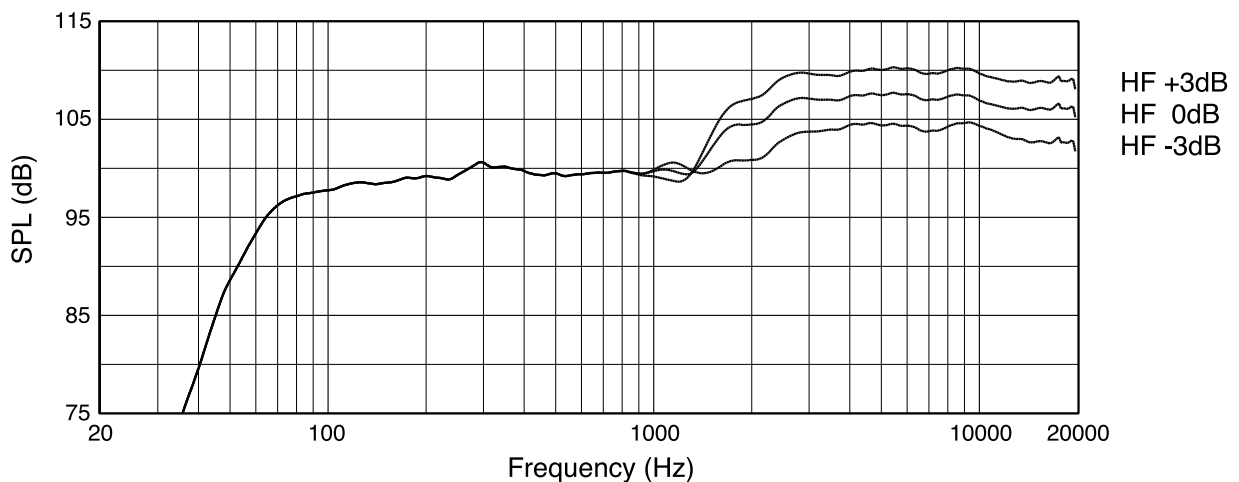

ARRAY CONFIGURATION SELECTOR (ACS)

Below is an example of applying the ACS in a three-speaker array. In this particular configuration, the ACS on the top speaker is set at +3 dB, the middle speaker at 0 dB, and the bottom speaker -3 dB.

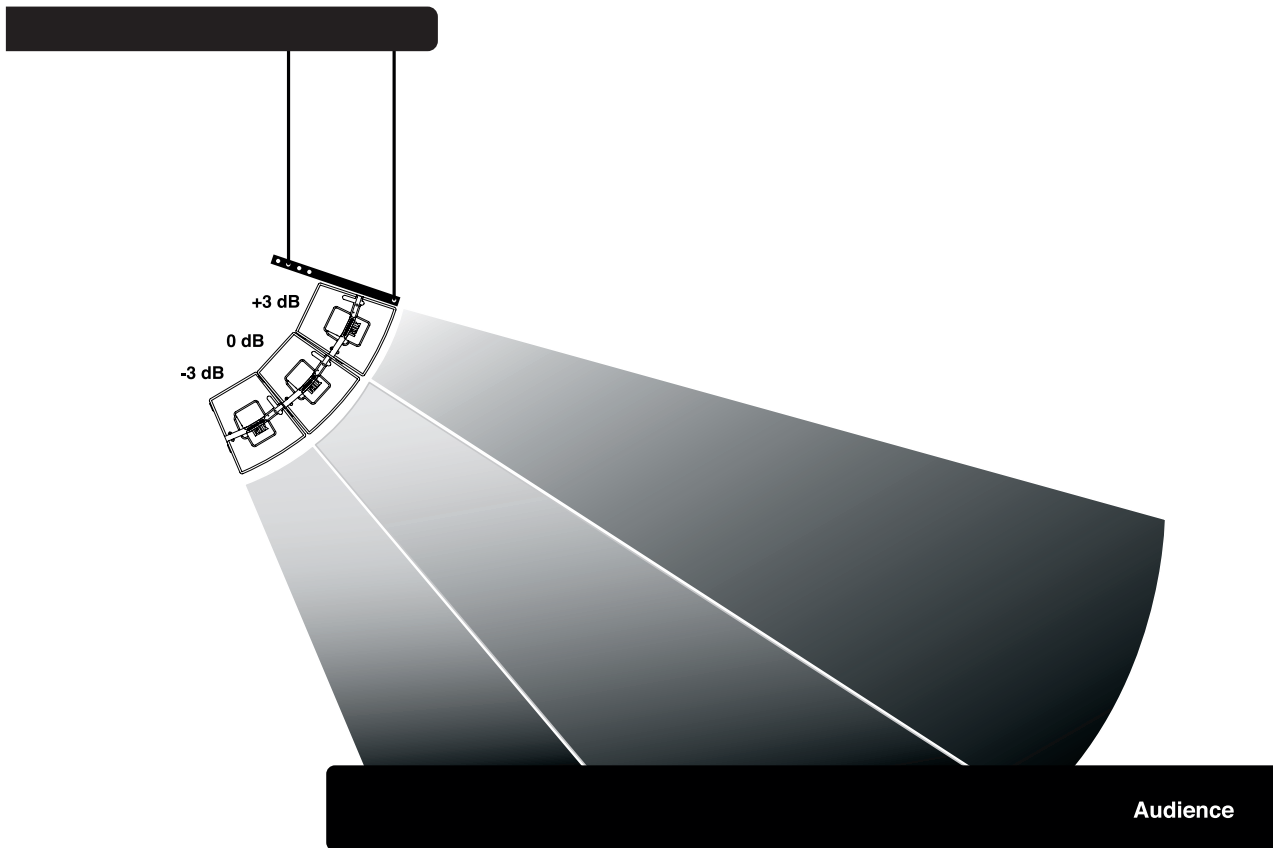

SECTION 6: DEPLOYING THE SYSTEM

The VRX932LAP/VRX918SP are flexible speaker systems that can be deployed in ground-supported or suspended applications. The following information will help you set up your VRX932LAP/VRX918SP system safely and effectively.

POLE AND TRIPOD SAFETY WARNINGS!

When using stands or poles, be sure to observe the following precautions:

- Check the stand or pole specification to be certain the device is designed to support the weight of the speaker. Observe all safety precautions specified by the manufacturer.
- Be certain that the surface on which the system is to be stacked is flat, stable and solid.
- Route cables so that performers, production crew, and audience will not trip and topple the speakers.
- Inspect the stand (or pole and associated hardware) before each use and do not use equipment with worn, damaged, or missing parts.
- Do not attempt to place more than two VRX932LAP loudspeakers on a stand or pole.
- When mounting two VRX932LAP speakers on a pole or tripod, integral rigging hardware must be used to secure the speakers to each other.
- Always be cautious when deploying the system outdoors. Unexpected winds may topple a system. It may be necessary to place additional weight (i.e. sandbags) on the base of the stand to improve stability. Avoid attaching banners or similar items to any part of a speaker system. Such attachments could act as a sail and topple the system.
- Unless you are confident that you can handle the weight of the speaker, ask another person to help you get it onto the tripod stand or pole.
- One or two VRX932LAP cabinets may be mounted onto either a JBL SS2-BK tripod stand or with the SS4-BK adjustable pole mount to their companion VRX918SP subwoofers. **Do not mount VRX932LAP cabinets on top of the compact VRX915S subwoofer!**

SINGLE VRX932LAP

A single VRX932LAP may be used on a tripod stand (JBL SS2-BK) or on a pole (JBL SS4-BK) over its companion subwoofer the VRX918SP. The use of a subwoofer is recommended for applications requiring more low-frequency power and extension. Usually, the Array Configuration Selector (ACS) switches on the input panel should be set to the “Short Throw (-3 dB)” position when a single speaker is used.

The VRX932LAP includes a dual angle 36 mm pole mount socket. By selecting the appropriate pole socket and adjusting the height of the tripod or pole, optimum coverage may be achieved. Ideally, the audience should not be able to see either the bottom or the top surfaces of the speaker. This will ensure that all listeners are within the “included coverage angle” of the loudspeaker. The rear pole-socket will position the speaker with the baffle 2.5° to the floor while the forward socket will position the speaker with the baffle angled down by 15°. System illustration shows the available JBL SS2-BK tripod stand.

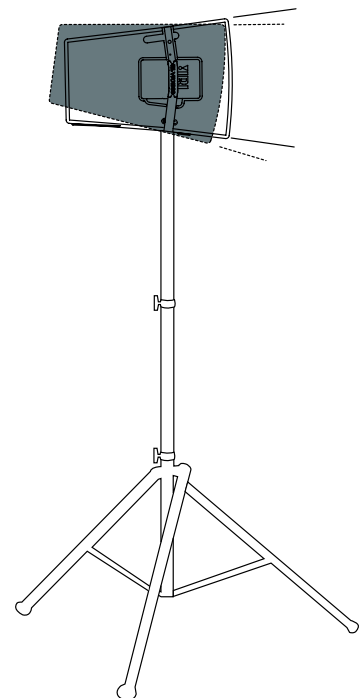

DUAL VRX932LAP

Unlike most conventional speakers, the VRX932LAP is designed so that a pair of speakers may be safely mounted onto a pole or tripod stand. For most applications, the forward socket of the dual angle pole socket will be used. This will tilt the lower of the two speakers at a 15° down-angle (providing coverage of the near listeners) while the upper speaker will face straight out (covering the more distant areas). Ideally, the listeners should not be able to see either the bottom or the top surfaces of the two-speaker array. Usually, the Array Configuration Selector (ACS) switches on the lower speaker's input panel should be set to the "Short Throw (-3 dB)" position while the upper speaker will be set to either "Short Throw (-3 dB)" or "Mid Throw (0 dB)".

Place the speakers on the pole or tripod one at a time. Be sure to lock the two speakers together using the integral rigging hardware (see below). System illustration shows available JBL SS4-BK speaker pole and SRX718S subwoofers. **Do not stack more than two VRX932LAP speakers on a pole.**

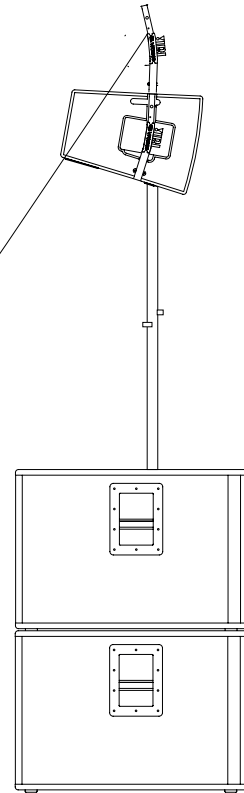

LOCKING (2) VRX932LAP LOUDSPEAKERS TOGETHER

Any time two or more VRX932LAP are arrayed together, they must be mechanically secured to each other using the integral rigging frame and supplied quick release pins. See the diagram below for details.

WARNING: Only the correct quick release pins supplied by JBL are to be used.

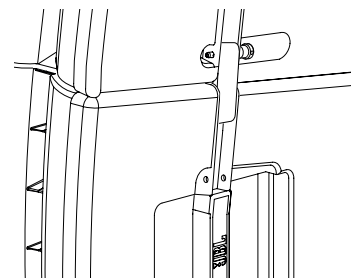
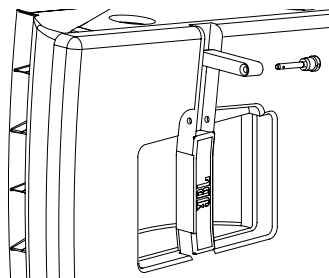
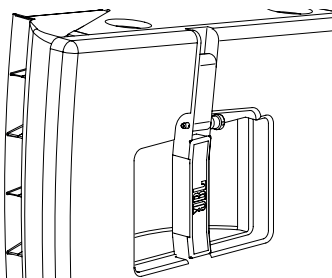

SECTION 7: SUSPENSION SAFETY WARNINGS!

Correct use of all rigging hardware is required for secure system suspension. Careful calculations should always be performed to ensure that all components are used within their Maximum Load Limit before the array is suspended. Never exceed the maximum recommended load ratings. Prior to suspending the system, an expert, trained and experienced in flying speaker systems should be consulted. Research and understand the codes, practices, and requirements in the venues where you intend to operate your sound system.

INSPECTION & MAINTENANCE

Before suspending or pole mounting any speaker system always inspect all components (enclosure, rigging frames, pins, eyebolts, track fittings, etc.) for cracks, deformations, corrosion, missing, loose or damaged parts that could reduce strength and safety of the array. Do not suspend or pole mount the speaker until the proper corrective action has been taken. Installed systems should be inspected at least annually. The inspection shall include a visual survey of all corners and load bearing surfaces for signs of cracking, water damage, de-lamination, or any other condition that may decrease the strength of the loudspeaker enclosure. Accessory rigging hardware provided with or for the JBL VRX932LAP or VRX918SP loudspeaker must be inspected for fatigue at least annually or as required by local ordinance. For all other hardware and fittings, refer to the hardware manufacturer's inspection and maintenance guidelines for process.

ARE YOU NEW TO RIGGING?

If you are new to rigging, you should do the following:

- Read and study JBL Technical Note Volume 1, Number 14: Basic Principles for Suspending Loudspeaker Systems (available at http://www.jblpro.com/pub/technote/tn_v1n14.pdf).
- Know the rules for safe rigging.
- Attend a safe rigging seminar, such as that presented by professionals like Rigging Seminars™ (www.riggingseminars.com) or by Chain Motor Hoist manufacturers like Columbus McKinnon Corp. (manufacturers of the C/M Lodestar).
- Meet and establish a relationship with a licensed mechanical or structural engineer. Get in the habit of asking them questions instead of guessing about their answers. Learn from what they tell you.
- Meet and discuss this aspect of your business with your Insurance Agent.

ATTACHMENT TO STRUCTURES

A licensed Professional Engineer must approve the placement and method of attachment to the structure prior to the installation of any overhead object. The following performance standards should be provided to the Professional Engineer for design purposes; Uniform Building Code as applicable, Municipal Building Code as applicable, and Seismic Code as applicable. The installation of the hardware and method of attachment must be carried out in the manner specified by the Professional Engineer. Improper installation may result in damage, injury or death.

JBL is not responsible for the application of its products for any purpose or the misuse of this information for any purpose. Furthermore, JBL is not responsible for the abuse of its products caused by avoiding compliance with inspection and maintenance procedures or any other abuse.

MAXIMUM ARRAY SIZE

There are three variations of the VRX array frame. The VRX-AF supersedes the VRX932LA-AF. The VRX-SMAF is solely intended for use with the VRX928LA and VRX915S. Before suspending a VRX array, determine which version of the array frame you have and consult the table below to determine the maximum number of speakers that may be safely suspended. The subwoofers must always be at the top of the array.

NOTE: For combination of passive and powered speaker systems use the table for powered speakers (VRX932LAP and VRX918SP).

VRX-AF ARRAY FRAME

The following table defines the maximum number of speakers that may be suspended using the VRX-AF frame. A minimum design factor of 7:1 is maintained for all speaker configurations at or below those indicated in the table.

Maximum number of VRX918SP in array	0	2	3	3	4	4
Maximum number of VRX932LAP in array	5	4	3	2	1	0

VRX932LA-AF Array Frame

WARNING: Do not use the older VRX932LA-AF array frame to suspend powered VRX932LAP or VRX918SP systems

INSTALLING THE ARRAY FRAME

The array frame is attached to the internal rigging of the VRX900 system using the provided Quick Release Pins

WARNING: Do not use any substitute for these pins.

1. Begin by attaching the two side arms (A) to either side of the center frame. Use a pair of the provided Quick Release Pins (B) to attach the arms to the frame.

NOTE 1: Side arms should be attached with the rubber bumper facing up and away from the center frame. The center frame is installed with the rubber gasket toward the enclosure and the label right side up.

NOTE 2: The arms of the VRX932LA-AF and VRX-AF are deliberately designed so as not to be interchangeable. The arms of the VRX-SMAF are already attached.

2. Place the entire array frame on top of the VRX900 system and flip up the drop levers (C) found on both sides of the speaker to be received by the array frame arms.

3. Once the drop levers on the speaker are received by the array frame, use a pair of the provided Quick Release Pins (D) to attach the drop levers to the array frame.

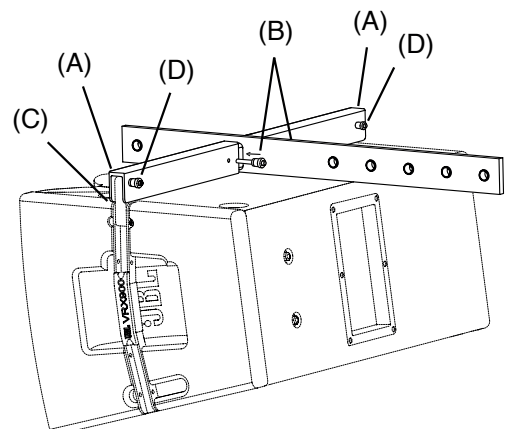

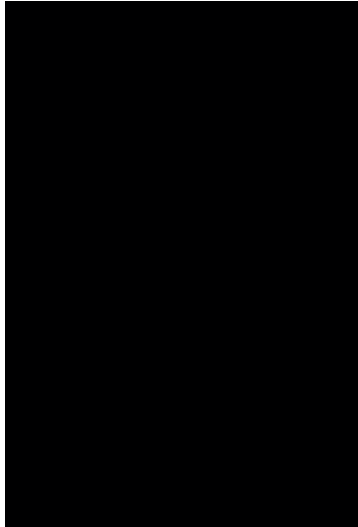

GROUND-STACKED, UPWARD FIRING ARRAYS

Applications such as covering stadium bleachers from the playing field may be addressed by installing the array frames to the bottom of the array.

Up to four VRX932LAP loudspeakers may be locked together and ground stacked using the VRX array frame kit, as shown.

WARNING: Do not ground stack more than four VRX932LAP loudspeakers in one array.

When ground stacking VRX932LAP loudspeakers, use the VRX-AF array frame as the base (as shown) by attaching the loose drop levers, included in the array frame kit, to the lower rigging bar on the VRX932LAP loudspeaker. When stacking the loudspeakers together, make sure each loudspeaker is locked together. Be certain that the surface on which the system is to be stacked is flat, stable and solid.

SECTION 8 : INTRODUCTION TO THE VRX-AF

The VRX-AF is an array frame designed to be used for suspension of the VRX932LAPand VRX918SP loudspeaker systems. The optional array frame kit includes the following items:

- 1 x center frame
- 2 x side arms
- 4 x quick release pins
- 2 x drop levers
- 2 x 3/8" shackles

WORKING LOAD LIMIT

The VRX-AF, VRX932LA-AF, and VRX-SMAF array frames have been precisely engineered to work together with the VRX line of speakers as a system. The working load limit depends upon the configuration of array frame and speakers being suspended. Please refer to the “DEPLOYING THE SYSTEM” section of this user guide for maximum allowable load limits when using the VRX-AF, VRX-SMAF or VRX932LA-AF frame.

Use of the array frames in any manner other than as described in this manual could result in damage to the frame and pose a risk of injury or death.

DIMENSIONAL DRAWINGS FOR VRX-AF

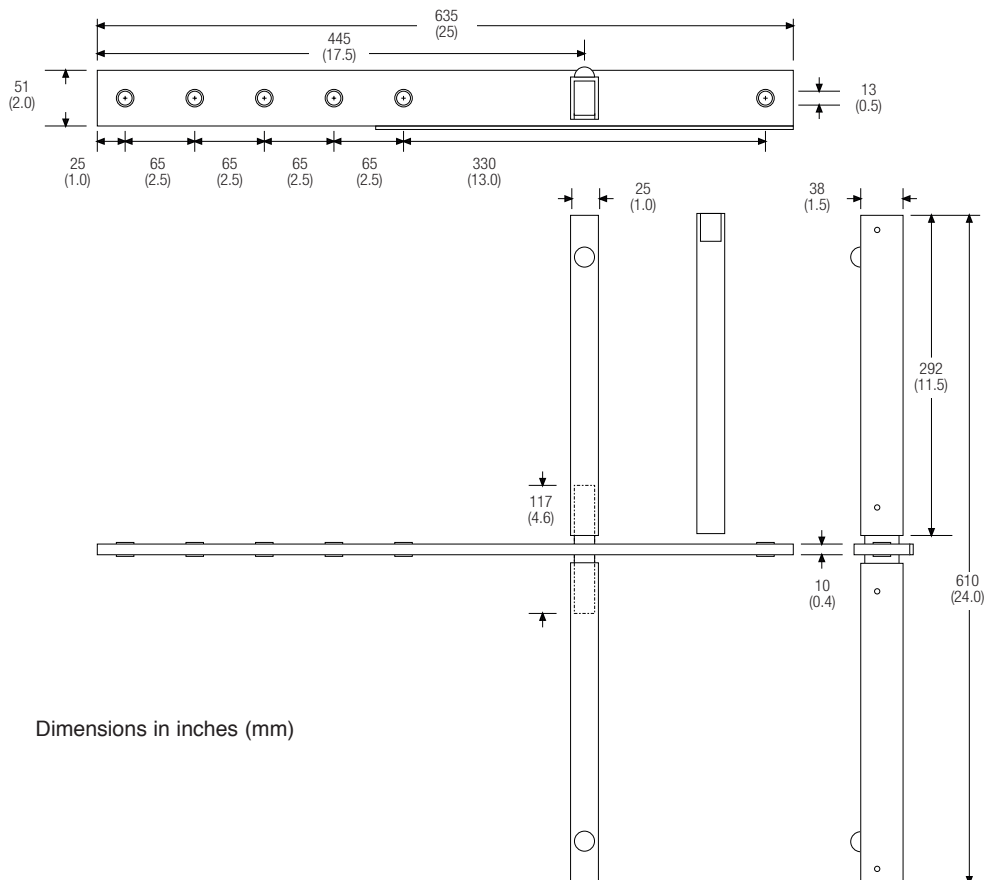

JBL WARRANTY AND INFORMATION

The JBL Warranty on professional loudspeaker products (except for enclosures) remains in effect for five years from the date of the first consumer purchase. JBL amplifiers are warranted for three years from the date of original purchase. Enclosures and all other JBL products are warranted for two years from the date of original purchase.

WHO IS PROTECTED BY THIS WARRANTY?

Your JBL Warranty protects the original owner and all subsequent owners so long as: A.) Your JBL product has been purchased in the Continental United States, Hawaii or Alaska. (This Warranty does not apply to JBL products purchased elsewhere except for purchases by military outlets. Other purchasers should contact the local JBL distributor for warranty information.); and B.) The original dated bill of sale is presented whenever warranty service is required.

WHAT DOES THE JBL WARRANTY COVER?

Except as specified below, your JBL Warranty covers all defects in material and workmanship. The following are not covered: Damage caused by accident, misuse, abuse, product modification or neglect; damage occurring during shipment; damage resulting from failure to follow instructions contained in your Instruction Manual; damage resulting from the performance of repairs by someone not authorized by JBL; claims based upon any misrepresentations by the seller; any JBL product on which the serial number has been defaced, modified or removed.

WHO PAYS FOR WHAT?

JBL will pay all labor and material expenses for all repairs covered by this warranty. Please be sure to save the original shipping cartons because a charge will be made if replacement cartons are requested. Payment of shipping charges is discussed in the next section of this warranty.

HOW TO OBTAIN WARRANTY PERFORMANCE

If your JBL product ever needs service, write or telephone us at JBL Incorporated (Attn: Customer Service Department), 8500 Balboa Boulevard, PO Box 2200, Northridge, California 91329 (818-893-8411). We may direct you to an authorized JBL Service Agency or ask you to send your unit to the factory for repair. Either way, you'll need to present the original bill of sale to establish the date of purchase. Please do not ship your JBL product to the factory without prior authorization. If transportation of your JBL product presents any unusual difficulties, please advise us and we may make special arrangements with you. Otherwise, you are responsible for transporting your product for repair or arranging for its transportation and for payment of any initial shipping charges. However, we will pay the return shipping charges if repairs are covered by the warranty.

MAILING ADDRESS:

JBL Professional
8500 Balboa Blvd.
Northridge, CA 91329 USA

SHIPPING ADDRESS:

JBL Professional
8370 Balboa Blvd., Dock D
Northridge, CA 91329 USA
(Do not return product to this address without first obtaining prior authorization from JBL)

CUSTOMER SERVICE:

Monday through Friday
8:00am - 5:00pm
Pacific Standard Time In the U.S.A.
(800) 8JBLPRO (800.852.5776)
www.jblproservice.com

OUTSIDE THE USA:

Contact the JBL Professional Distributor in your area. A complete list of JBL Professional international distributors is provided at our U.S.A. website - www.jblpro.com

PRODUCT REGISTRATION:

Register your product online at www.jblpro.com/registration

ON THE WORLD WIDE WEB:

www.jblpro.com

VRX900

S E R I E S

Free Manuals Download Website

<http://myh66.com>

<http://usermanuals.us>

<http://www.somanuals.com>

<http://www.4manuals.cc>

<http://www.manual-lib.com>

<http://www.404manual.com>

<http://www.luxmanual.com>

<http://aubethermostatmanual.com>

Golf course search by state

<http://golfingnear.com>

Email search by domain

<http://emailbydomain.com>

Auto manuals search

<http://auto.somanuals.com>

TV manuals search

<http://tv.somanuals.com>