

S
Y
N
T
H
E
S
I
S[®]

JBL

SYNTHESIS[®] ARRAY[™] MODULE
**SAM1HF,
SAM2LF**
MODULAR ARRAY
LOUDSPEAKER
OWNER'S AND
INSTALLER'S
MANUAL

CONTENTS

INTRODUCTION	3
INCLUDED	4
SPEAKER PLACEMENT	4
LEFT AND RIGHT SPEAKERS	4
CENTER CHANNEL SPEAKERS	4
AMBIENT SURROUND SPEAKERS	5
5.1-CHANNEL SYSTEMS	5
6.1-CHANNEL SYSTEMS	6
7.1-CHANNEL SYSTEMS	6
SAM1HF AND SAM2LF CONFIGURATION AND ASSEMBLY	7
CONNECTING THE SPEAKERS TO THE REST OF YOUR SYSTEM.....	10
PREPARING THE HOOKUP WIRE	10
CONNECTIONS TO THE SYNTHESIS ELECTRONICS	10
INPUT/OUTPUT ASSIGNMENTS WITH ACTIVE CROSSOVER	11
INPUT/OUTPUT ASSIGNMENTS WITH PASSIVE CROSSOVER.....	13
CONNECTION NOTES.....	13
TROUBLESHOOTING.....	15
SPECIFICATIONS	16

INTRODUCTION

Thank you for purchasing this JBL Synthesis® Array™ Module home theater speaker. This product represents the synthesis of everything that JBL has learned about the emotional power of audio and video in sixty years of preeminence in the field. It sets new benchmarks in the use of “high technology” and provides you with the experience of being in some of the world’s greatest movie houses and concert halls, right at home! JBL’s Synthesis Array speaker systems feature the following:

THX ULTRA2™-LICENSED HOME AUDIO SYSTEM: When used with a THX® controller and amplifiers, your speaker system will deliver a state-of-the-art THX home theater experience to your living room. You will hear in your home exactly what the director and sound engineer heard in the recording studio. The system will reproduce the audio flawlessly and without distortion.

ULTRAHIGH-FREQUENCY COMPRESSION DRIVER: 1" (25mm) Pure-titanium compression driver with aluminum edge-wound voice coil and 2" (51mm) neodymium motor assembly, mounted in a SonoGlass® constant-directivity horn for extended high-frequency response to exceed SACD™ and DVD-Audio specifications.

HIGH-POWER COMPRESSION HORN: Horns are commonplace in movie theaters across the world, because of their high power handling and well-defined high-frequency output. The horns employed in SAM1HF have very low distortion and a well-controlled directivity, to put the dialogue at the center of the screen and the effects all around you.

ACCURATE MID-BASS DRIVERS AND SUBWOOFERS: The 8" (200mm) mid-bass drivers incorporate many of JBL’s patented technologies – such as Symmetrical Field Geometry™ (SFG), Symmetrical Inductance Modulation (SIM) and Vented Gap Cooling™ (VGC) – as well as unique cone and dome materials, to provide tight, smooth midrange sound without harshness, stridency or listener fatigue. From two to as many as four 15" or 18" (380mm or 457mm) high-power subwoofers complete the experience with earth-shattering, deep bass.

COMMON VOICING: Synthesis Array uses common voicing across the front three channels. Since identical drivers are used, each speaker has the same tonal qualities, thus as a sound is panned from one side to the other, there will be no change in timbre.

MAGNETIC SHIELDING: All front speakers are magnetically shielded, allowing you to place them near video monitors without generating interference or distorting the picture.

DUAL “INSIDE” NEODYMIUM MOTOR STRUCTURE: Two neodymium magnets are used. The “top” neodymium magnet is magnetized with opposite polarity to the main, lower neodymium magnet. This inverted dual-magnet configuration improves magnetic shielding and offers increased acoustic output.

DEEP-ANODIZED CONE AND DOME MATERIAL: The special deep-anodized aluminum cone and dome material, together with the motor features, helps to reduce midband distortions to very low levels (approximately 50dB to 60dB below the fundamental signal driven at 100dB output).

TWO-STAGE PHASE PLUG: The phase plug is a key element in this compression driver. The accuracy of the phase plug geometry is most important to achieve a wide and flat frequency response. The pressure distribution in the phase plug is manipulated by adjustments to the number and width of the slots and is optimized to achieve a coherent pressure front across the operating range at the exit of the phase plug.

SYMMETRICAL INDUCTANCE MODULATION (SIM): The flux-stabilizing ring and copper gap ring are also optimized for size and position, to help minimize or eliminate “asymmetrical inductance modulation.” Minimizing this asymmetrical inductance modulation leads to even further distortion reduction and improved vocal clarity.

INCLUDED

SAM1HF

(2) mounting brackets: metal brackets for mounting to the SAM2LF module

(4) knobs: used to securely hold the mounting brackets to the cabinet

SAM2LF

(2) mounting brackets: metal brackets for mounting to the SAM1HF module

(4) knobs: used to securely hold the mounting brackets to the cabinet

SPEAKER PLACEMENT

Positioning your loudspeakers properly is critical in order to achieve the sonic performance of a home theater. Please read the following section for guidance in correct and optimal placement.

LEFT AND RIGHT SPEAKERS: If you have purchased a Synthesis Array Module digital home theater system, then one of the configurations of the SAM1HF/SAM2LF modules will serve as your front left and right main speakers. Please see the Configuration and Connection diagrams in the "SAM1HF and SAM2LF Configuration and Assembly" section to correctly configure your main speakers.

Since the left and right speakers have been designed for maximum localization of sound, they should be placed with the center of the speakers at about the same height on screen as the actors would be, to aid in the illusion that the actors' voices are coming directly from their on-screen images. Ideally, the speakers will be placed about 45 degrees apart from each other, viewed from the listening position, so that the distance between the speakers is the same as each speaker's distance from the listener (see Figure 1).

CENTER CHANNEL SPEAKERS: Please see the Configuration and Connection diagrams in the "SAM1HF and SAM2LF Configuration and Assembly" section to correctly configure your center speaker. Regardless of the configuration you have chosen, it is important to place the horn array vertically during installation in order to take advantage of its sound-dispersion characteristics. If you mount it horizontally, it will not provide the correct dispersion pattern. If the speaker is being used with a perforated projection screen, it should be mounted behind the center of the screen (see Figure 2).

If a nonperforated projection screen, plasma display or other fixed video device is being used in the installation, then the recommended location is directly below (and as close as possible to) the video display (see Figure 3), although the inverse of this method will work also.

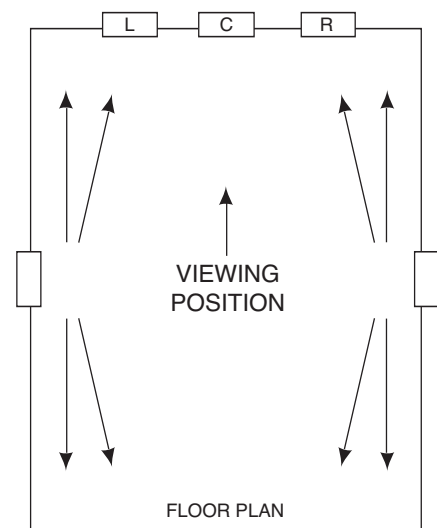

Figure 1. 5.1-Channel system

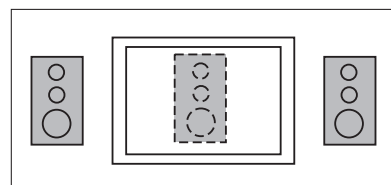

Figure 2.

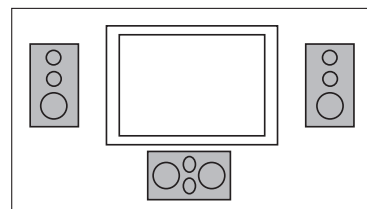

Figure 3.

SPEAKER PLACEMENT

NOTE: It is extremely important to place the tweeter/mid-bass arrays for each of the center, left and right speakers at the same height. The horn array containing the tweeter in the center channel speaker should be no more than two feet (0.6 meter) higher or lower than those in the left and right speakers. This preserves the “localization integrity” of “sound pans,” in which the sound appears to move from left to center to right. If the program material also appears to travel up and down, it can destroy the illusion of panning effects and so should be avoided.

AMBIENT SURROUND SPEAKERS: Although it has been common for many years to use a number of surround speakers in commercial movie houses, until recently, the traditional home theater configuration called for 5.1 channels, i.e., front left, center, front right, surround left and surround right, plus a low-frequency effects channel. The newer surround formats that are appearing in consumer audio equipment are calling for more complicated 6.1- and 7.1-channel systems. The advantages of using additional speakers are many. Additional channels enable a more versatile use of directionality for a more accurate surround presentation. Also, a higher overall sound-pressure level can be achieved with less energy expenditure from any individual speaker. Placement of the surround speakers remains critical.

5.1-CHANNEL SYSTEMS

The ambient surround speakers work optimally if they are placed as far back from the screen as the viewing chairs are. If there are two rows of chairs, these speakers should be placed between them.

The ambient surround speakers should be placed higher than the seating area, at least two feet (0.6 meter) above (seated) ear level (see Figure 4).

The preferred method to mount the ambient surrounds is to put them directly in the side walls. This lets each speaker radiate to the front and back of the room and to reflect off the side walls.

There are a few instances in which the ambient surrounds would perform better if mounted in the ceiling rather than the walls. If one or both of the walls are “acoustically dead,” due to the presence of windows, fabric, furniture or other absorption, it may be necessary to turn the ambient speakers sideways and, instead of mounting them in a vertical orientation, mount them in the ceiling in a horizontal orientation.

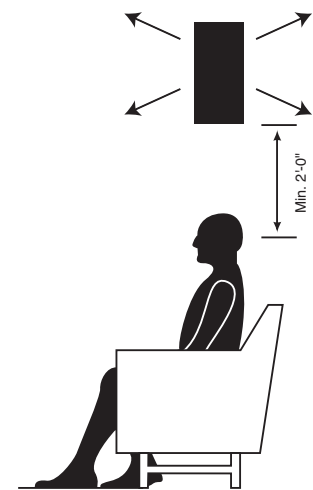

Figure 4.

SPEAKER PLACEMENT

6.1-CHANNEL SYSTEMS

A 6.1-channel system can be thought of as a 5.1-channel system with the addition of a rear center speaker placed midway between the two surround speakers, and further to the rear than the surrounds. It should be placed at the same height as the side surround speakers (see Figure 5).

7.1-CHANNEL SYSTEMS

In a 7.1-channel system, two speakers are added for rear fill, in addition to the surround speakers in a 5.1-channel system. The two additional speakers are placed on the rear wall or near the rear wall in the ceiling (see Figure 6).

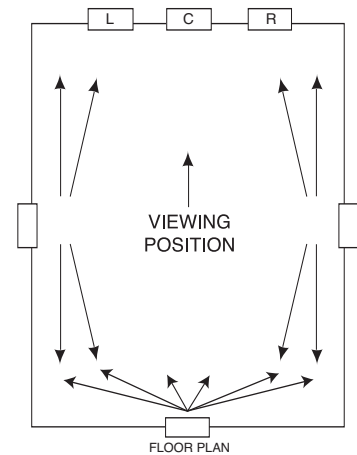

Figure 5. 6.1-Channel system

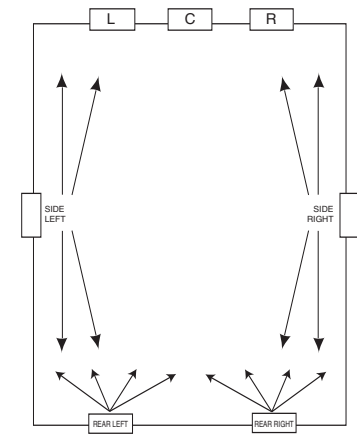

Figure 6. 7.1-Channel system

SAM1HF AND SAM2LF CONFIGURATION AND ASSEMBLY

The different configurations of speaker arrays are accomplished by combining one (1) SAM1HF module with at least one (1) and up to four (4) SAM2LF modules. The configuration of your system depends greatly on room size and at what SPL the system will be used. The different array configurations can be used to customize individual speakers for any application in any system. Typical uses would be as front left, front right and center channel speakers, but they can also be used as direct radiating surround speakers. A basic speaker array will consist of one (1) SAM1HF and one (1) SAM2LF as a three-way bi-amped speaker with an active crossover located in the Synthesis Digital EQ or as a three-way passive speaker when used with the SAM12x crossover.

NOTE: The SAM1HF is the high-frequency horn module, and the SAM2LF is the low-frequency woofer module; you must use at least one of each for a complete speaker system.

The modules are physically connected to each other by using the included connecting bars and hand-tightened knobs to mount the modules together. There are multiple mounting points, and several bars should be used to maintain a rigid connection. **Be careful while constructing the module array, as it may become unsteady and tip over. Make sure the completed speakers are securely mounted and will not fall over, as they may be very heavy and could cause serious damage if not properly handled.**

Any module can be connected to any other module. We have identified four recommended and supported configurations. For all configurations, you should observe the following mounting guidelines:

FOR VERTICAL MOUNTING:

1. When mounting the SAM1HF to the SAM2LF with the SAM1HF on top, be sure to keep the modules from separating while you tighten the bars. This can be accomplished simply by keeping downward pressure on the front of the module while tightening the screws from the rear.
2. Use at least two mounting bars, running from the top to the bottom of the modules.
3. Use at least four hand screws, two on each module, with four on each module preferred.

FOR HORIZONTAL MOUNTING:

1. When mounting the SAM1HF to the SAM2LF, it is important to keep the top of the modules aligned. This is accomplished by turning the modules upside down before you begin mounting them together. Once you have finished, be sure to turn them right side up.
2. Use at least two mounting bars, running from the top to the bottom of the modules.
3. Use at least four hand screws, two on each module, with four on each module preferred.
4. The bars will not extend beyond two modules. If you are connecting three across (as in a dual-woofer module design), use two sets of bars, each connected to the center module.

FOR A COMBINATION OF HORIZONTAL AND VERTICAL MOUNTING:

1. Attach the vertical modules first.
2. Attach the horizontal modules second.
3. Overlap the mounting bars so that they form a stiff construction.

TRIM PANEL (BAFFLE BLOCKS) INSTALLATION:

1. Purchase the correct trim panels for your configuration.
2. The trim panels will act as both the cosmetic and structural finish of the speaker.

SAM1HF AND SAM2LF CONFIGURATION AND ASSEMBLY

IMPORTANT NOTE: Do not place the SAM1HF on its side. It must be mounted with the UHF DRIVER on the top, as shown below. Failure to do this will have a negative impact on the performance of this speaker.

Detailed Configurations and System Connection

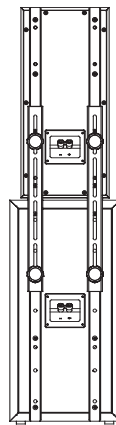
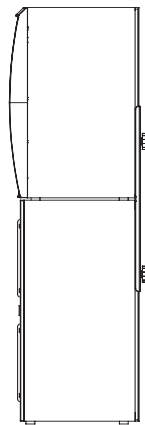
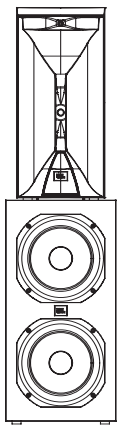
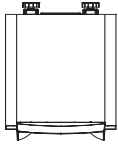

Configuration 1: One SAM1HF and one SAM2LF vertical

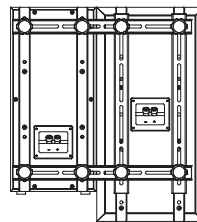
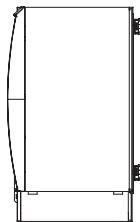
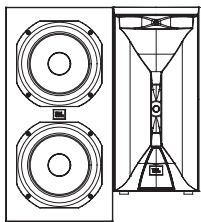
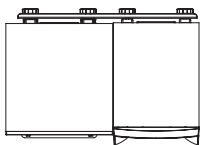

Configuration 2: One SAM1HF and one SAM2LF horizontal

NOTE: Shown without the trim panel (baffle blocks) installed on the SAM1HF.

SAM1HF AND SAM2LF CONFIGURATION AND ASSEMBLY

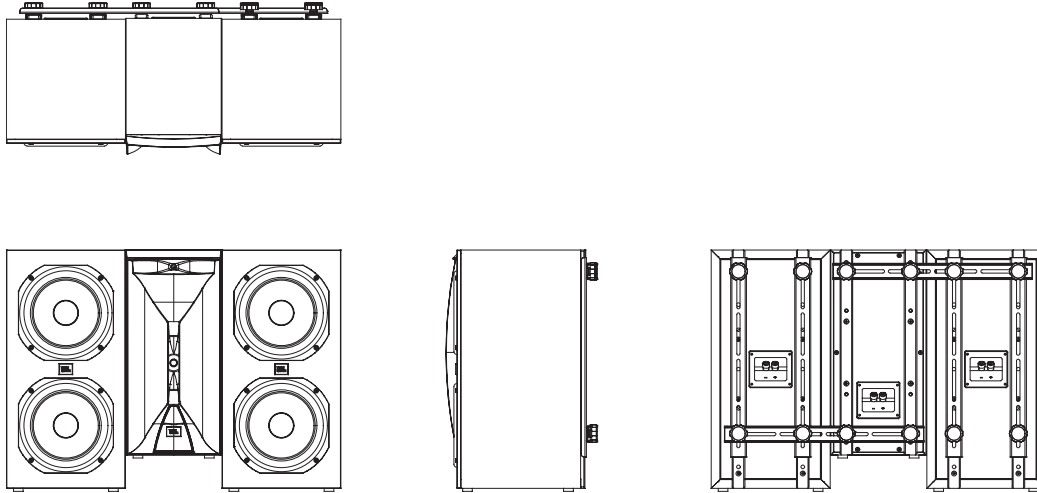

Configuration 3: One SAM1HF and two SAM2LF horizontal

NOTE: Shown without the trim panel (baffle blocks) installed on the SAM1HF.

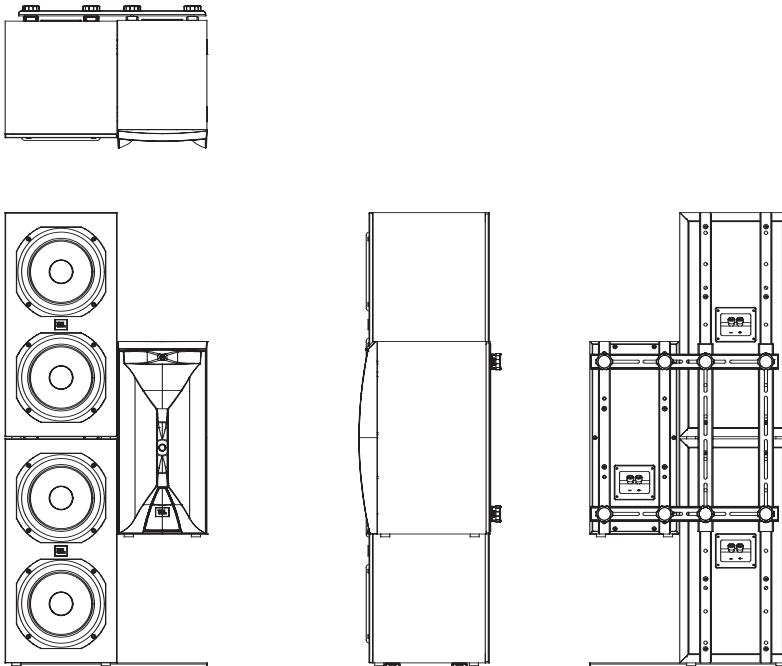

Configuration 4: One SAM1HF and two SAM2LF vertical

NOTE: Shown without the trim panel (baffle blocks) installed on the SAM1HF.

CONNECTING THE SPEAKERS TO THE REST OF YOUR SYSTEM

To connect the Synthesis Array loudspeakers to the power amplifiers or receiver, use two-conductor insulated speaker wire. We recommend #14 AWG wire as a minimum size. Your JBL dealer can recommend suitable cables. Both the SAM1HF and SAM2LF utilize push-style friction binding posts that can accommodate up to #10 AWG stranded wire.

PREPARING THE HOOKUP WIRE

1. First determine the distance between your amplifier and the most distant speaker in each group (fronts, surrounds, back surrounds, subwoofers).
2. Now make the hookup wires for all speakers in each group this length, even if one speaker is much closer to your amplifier than the other. This will help maintain proper signal balance.
3. Strip off 3/8" (10mm) of insulation from both ends of each conductor.
4. Twist each set of standard wires into a tightly bunched spiral.
5. Speakers and electronics terminals have corresponding (+) and (–) terminals. Most manufacturers of speakers and electronics, including JBL, use red to denote the (+) terminal and black for the (–) terminal, although some electronics manufacturers have adopted the new color-coding standard promulgated by the Consumer Electronics Association. In that case, the positive terminal will be colored to correspond to the channel position, while the negative terminal will be black.

It is important to connect all speakers identically: (+) on the speaker to (+) on the amplifier and (–) on the speaker to (–) on the amplifier. Wiring "out of phase" results in thin sound, weak bass and poor imaging.

With the advent of multichannel surround sound systems, connecting all of the speakers in your system with the correct polarity remains equally important to preserve the proper ambience and directionality of the program material.

Now find a visual difference between the two conductors of each molded pair of speaker wires. Differentiating marks can be a different color wire (copper or silver); a strand of yarn in one conductor; thin, raised ribs on one part of the outer insulation; or a printed marking on one part of the outer insulation. It doesn't matter which of the two strands go to the (+) and (–) on the speakers and amplifiers, as long as all speakers are connected identically. Push down on the binding post, insert the wire into the hole, and release.

CONNECTIONS TO THE SYNTHESIS ELECTRONICS

The SAM1HF and SAM2LF speaker modules do not have a built-in crossover. They must be used with the active crossover as designed in the SDEC-4000 digital equalizer in a bi-amplified configuration or with the outboard passive crossover, SAM12x, with the SDEC-3000. Each SAM module will require a single amplifier channel in a bi-amplified system. Connect the SAM modules according to the chart on the following page.

NOTES:

- The SAM1HF will connect to the HI output of the SDEC-4000 or SAM12x.
- The SAM2LF will connect to the LOW output of the SDEC-4000 or SAM12x.
- Please consult the SDEC-4000 and SDEC-3000 installation guide for detailed instructions.
- DO NOT use a full-range output from an amplifier, as damage may occur unless you are using the SAM12x.

CONNECTING THE SPEAKERS TO THE REST OF YOUR SYSTEM

INPUT/OUTPUT ASSIGNMENTS WITH ACTIVE CROSSOVER (BI-AMPED)

<i>Surround Processor to SDEC-4000P Inputs</i>		
<i>S4000IC Number</i>	<i>Channel</i>	<i>SDEC-4000P</i>
1	FRONT LEFT	A1
2	FRONT RIGHT	A2
3	CENTER	A3
4	LEFT SIDE	A4
5	RIGHT SIDE	B1
6	LEFT REAR	B2
7	RIGHT REAR	B3
8	SUBWOOFER	B4
	N/C	C1
	N/C	C2
	N/C	C3
	N/C	C4

<i>SDEC-4000P Outputs to Amplifiers</i>		
<i>S4000IC Number</i>	<i>Channel</i>	<i>SDEC-4000P</i>
21	SUBWOOFER 1	D1
22	SUBWOOFER 2	D2
23	SUBWOOFER 3	D3
24	SUBWOOFER 4	D4

NOTE: You must also connect both the CobraNet® audio connections and Ethernet control connections to complete the installation. See the SDEC-4000 installation guide for detailed instructions.

<i>SDEC-4000X Outputs to Amplifiers</i>		
<i>S4000IC Number</i>	<i>Channel</i>	<i>SDEC-4000X</i>
9	LEFT FRONT-LOW	A1
10	LEFT FRONT-HI	A2
11	RIGHT FRONT-LOW	A3
12	RIGHT FRONT-HI	A4
13	CENTER FRONT-LOW	B1
14	CENTER FRONT-HI	B2
15	LEFT SIDE 1	B3
16	LEFT SIDE 2	B4
	N/C	C1
	N/C	C2
17	RIGHT SIDE 1	C3
18	RIGHT SIDE 2	C4
	N/C	D1
	N/C	D2
19	LEFT REAR	D3
20	RIGHT REAR	D4

CONNECTING THE SPEAKERS TO THE REST OF YOUR SYSTEM

SDEC-4000 With Bi-Amplified Speakers (Active Crossover)

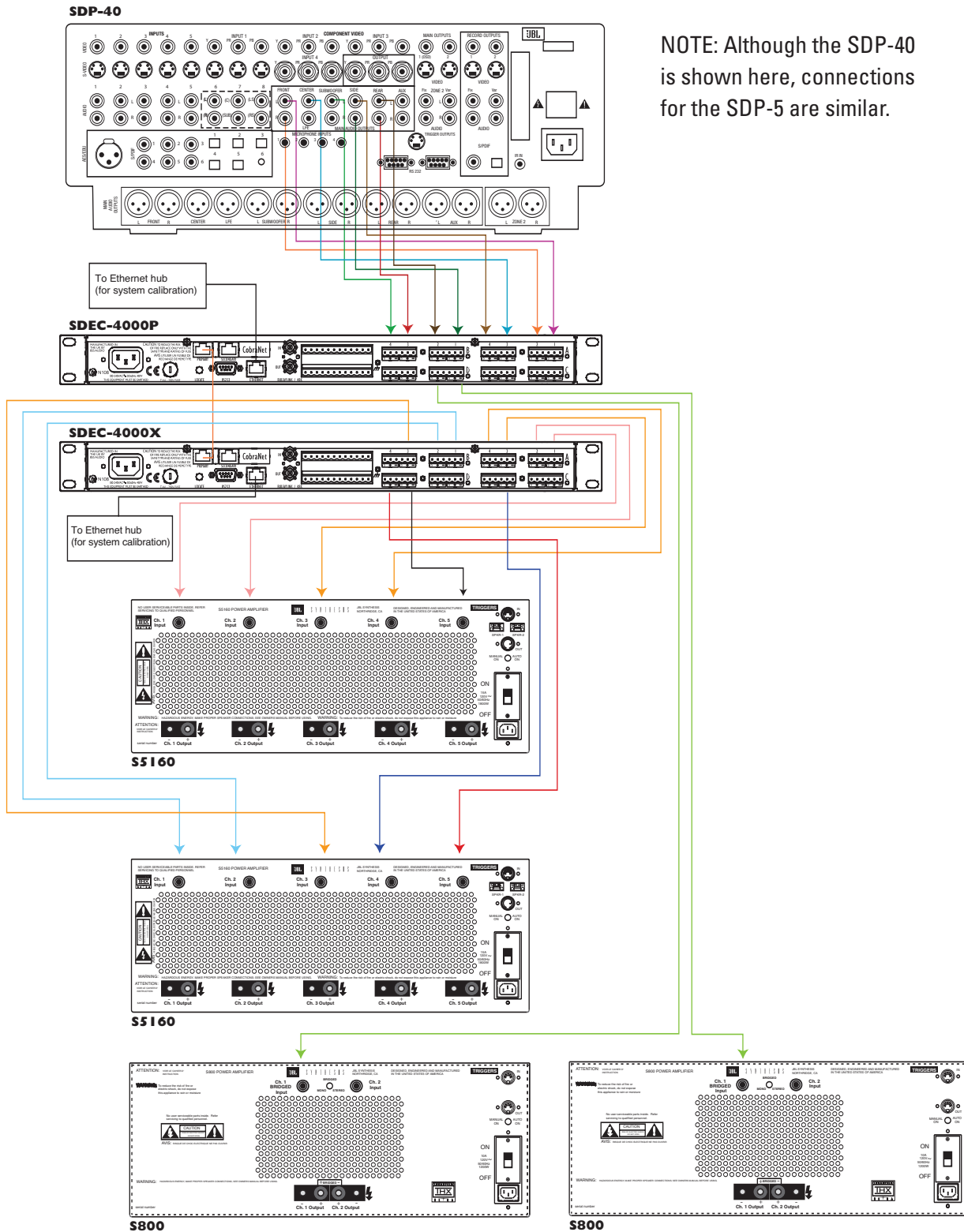

CONNECTING THE SPEAKER TO THE REST OF YOUR SYSTEM

INPUT/OUTPUT ASSIGNMENTS WITH PASSIVE CROSSOVER

The SDEC-3000 supports up to 7.1 input with up to 7.1 output. The input and output assignments are as described in the below chart. You must make the correct connections from the surround processor output to the amplifier input for the system to work correctly. Please refer to the connection diagram for more information.

The correct Synthesis Interconnect kit includes all the necessary connections for using the SDEC in the Synthesis system. Please be sure to order the S3000IC for use with SDEC-3000 and S4000IC for use with SDEC-4000. Retrofit kits are also available. Please contact JBL Synthesis Technical Support for more information at (888) 691-4171 (USA only).

CONNECTION NOTES

- Please follow the wiring diagram and the Input/Output Assignments chart for correct connections.
- You will need to use the Ethernet network port on the rear panel of the unit for the final calibration process. You can use a crossover network cable if you plan to connect directly to the SDEC-3000 from a computer. Alternatively, you can connect the SDEC-3000 through any standard Ethernet hub.
- When using the SDP-40 processor, make sure the subwoofer (in speaker setup) is set to Mono output and connect to the Subwoofer Left output. Do not use the LFE output.

<i>Surround Processor to SDEC-3000 Inputs</i>		
<i>S3000IC Number</i>	<i>Channel</i>	<i>SDEC-3000</i>
1	LEFT FRONT	A1
2	RIGHT FRONT	A2
3	CENTER FRONT	A3
4	LEFT SIDE	A4
5	RIGHT SIDE	B1
6	LEFT REAR	B2
7	RIGHT REAR	B3
8	SUBWOOFER (Mono Sub Left)	B4

NOTE: Place the SAM12x passive crossover as close to the speakers as possible. The SAM12x has a single speaker level input and multiple outputs for the SAM1HF and SAM2LF speaker modules.

<i>SDEC-3000 Outputs to Amplifiers</i>		
<i>S3000IC Number</i>	<i>Channel</i>	<i>SDEC-3000</i>
9	LEFT FRONT	C1
10	RIGHT FRONT	C2
11	CENTER FRONT	C3
12	LEFT SIDE	C4
13	RIGHT SIDE	D1
14	LEFT REAR	D2
15	RIGHT REAR	D3
16	SUBWOOFER	D4

CONNECTION TO THE REST OF THE JBL SYNTHESIS SYSTEM

SDEC-3000 With Passive Crossover (SAM12x)

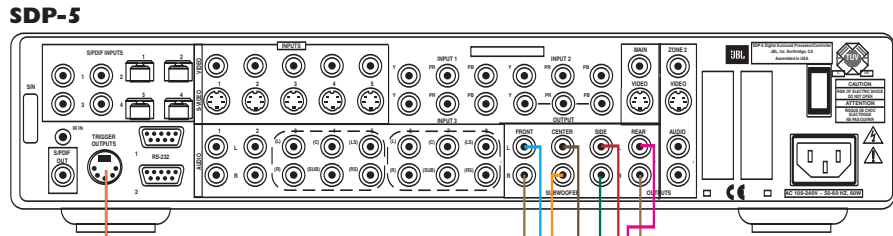

NOTE: Although the SDP-5 is shown here, connections for the SDP-40 are similar.

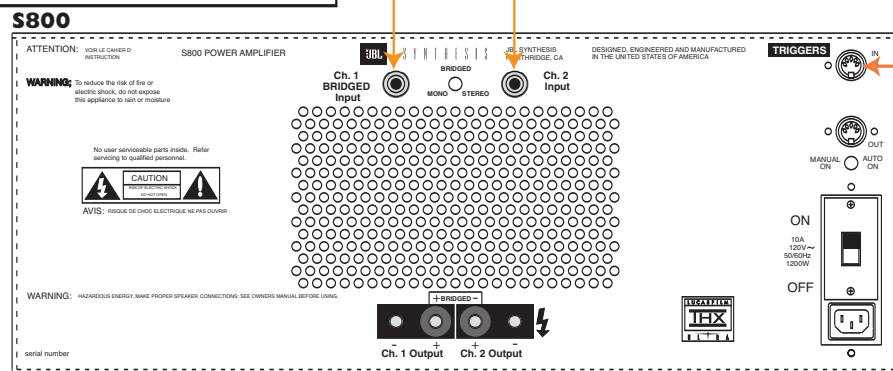
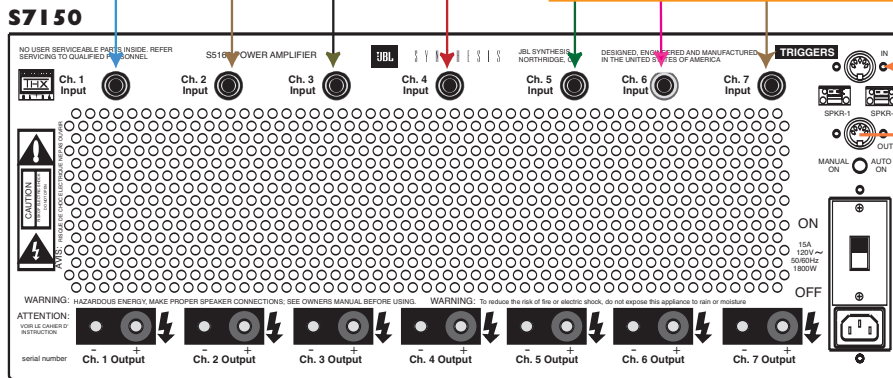
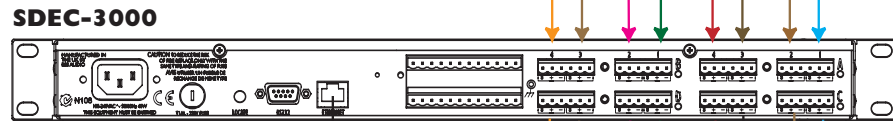

TROUBLESHOOTING

SYMPTOM	PROBABLE CAUSE	SOLUTION
<p>No sound coming from speaker</p>	<ul style="list-style-type: none"> • Amplifier not turned on • Amplifier gain is low • Correct source not selected or turned on • Defective patch cords to amplifier • Speaker wires not connected to amplifier • Balance control set improperly • Speaker wires damaged or shorted • Speaker not configured correctly • Center speaker is configured incorrectly • Problem not diagnosed 	<ul style="list-style-type: none"> • Turn on amplifier. • Make sure that there is amplifier gain for that channel. • Select proper source. • Check/replace patch cords. • Check speaker wire connection to amplifier. • Make sure Balance control is set at center, or 12 o'clock, position. • Make sure none of the speaker wires are frayed, cut or punctured. Make sure no wires are touching other wires or terminals and creating a short circuit. • In Dolby® Digital or DTS® mode, make sure that the receiver/processor is configured so that the speaker in question is enabled. • In Dolby Pro Logic® mode, make sure the center speaker is not in phantom mode. • To diagnose the likely source of the problem, it is often helpful to switch the nonfunctioning speaker with one that is functioning correctly. Turn off all electronics before exchanging the speakers. Turn everything back on, and determine whether the problem is in the same place, or has moved with the speaker. If the problem is in the same place, the source is most likely with your receiver or amplifier. If the problem has followed the speaker, then contact your authorized JBL Synthesis custom installer or dealer for further assistance. If that is not possible, visit our Web site at www.jblsynthesis.com for further information.
<p>Bass is very weak</p>	<ul style="list-style-type: none"> • Subwoofers are wired out of phase • Subwoofers have not been placed optimally 	<ul style="list-style-type: none"> • Make sure that positive terminals on the subwoofers go to the positive terminals on the amplifiers (red) and do the same for the negatives. • Experiment with different locations.

SPECIFICATIONS

	SAM1HF	SAM2LF
ULTRAHIGH-FREQUENCY DRIVER	045Ti 1" (25MM) PURE-TITANIUM COMPRESSION DRIVER WITH ALUMINUM EDGE-WOUND VOICE COIL AND 2" (51MM) NEODYMIUM MOTOR ASSEMBLY, MOUNTED IN A SONOGLASS® CONSTANT-DIRECTIVITY HORN	N/A
HIGH-FREQUENCY TRANSDUCER	435AL-1 3" (75MM) AQUAPLAS-TREATED ALUMINUM-DOME COMPRESSION DRIVER WITH ALUMINUM EDGE-WOUND VOICE COIL AND NEODYMIUM MOTOR ASSEMBLY, MOUNTED IN A VERTICAL SONOGLASS® CONSTANT-DIRECTIVITY HORN	N/A
LOW-FREQUENCY TRANSDUCER	N/A	8" (200MM) DEEP-ANODIZED ALUMINUM CONE AND DOME MATERIAL WITH DUAL "INSIDE" NEODYMIUM MAGNETS, SHIELDED MOTOR STRUCTURE AND 2" (51MM) VOICE COILS
SENSITIVITY (2.83V/1M)	98dB	92dB
FREQUENCY RESPONSE (-3dB)	36Hz TO 40kHz*	36Hz TO 40kHz*
MAX. RECOMMENDED AMPLIFIER POWER	300 WATTS	300 WATTS
CROSSOVER FREQUENCIES	9kHz	N/A
NOMINAL IMPEDANCE	6 OHMS	6 OHMS
DIMENSIONS (H x W x D)	17-1/4" x 8" x 11-1/2" ** (438MM x 200MM x 292MM)	20" x 10" x 10-3/4" ** (508MM x 254MM x 273MM)
WEIGHT PER SPEAKER	25 LB (11KG)	29 LB (13KG)
* Note 1: Frequency response is for the complete speaker module, SAM1HF/SAM2LF together.		
** Note 2: Dimensions do not include mounting hardware or feet. Add 3" (75mm) depth for mounting hardware, and 1" (25mm) height for feet.		

Features, specifications and appearance are subject to change without notice.

JBL, JBL Synthesis, Synthesis and SonoGlass are trademarks of Harman International Industries, Incorporated, registered in the United States and/or other countries. Array, Symmetrical Field Geometry and Vented Gap Cooling are trademarks of Harman International Industries, Incorporated.

CobraNet is a registered trademark of Peak Audio, a division of Cirrus Logic, Inc.

THX is a registered trademark, and THX Ultra2 is a trademark, of THX Ltd. All rights reserved.

SACD is a trademark of Sony Corporation.

Dolby and Pro Logic are registered trademarks of Dolby Laboratories.

DTS is a registered trademark of DTS, Inc.



Harman Consumer Group, Inc.
250 Crossways Park Drive, Woodbury, NY 11797

8500 Balboa Boulevard, Northridge, CA 91329
818.830.8757

www.jblsynthesis.com

H A Harman International Company

Part No. 361697-001 4/07

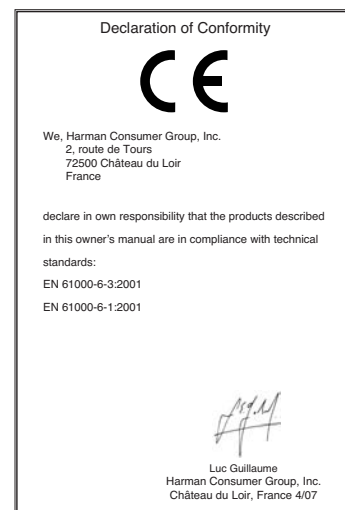

Free Manuals Download Website

<http://myh66.com>

<http://usermanuals.us>

<http://www.somanuals.com>

<http://www.4manuals.cc>

<http://www.manual-lib.com>

<http://www.404manual.com>

<http://www.luxmanual.com>

<http://aubethermostatmanual.com>

Golf course search by state

<http://golfingnear.com>

Email search by domain

<http://emailbydomain.com>

Auto manuals search

<http://auto.somanuals.com>

TV manuals search

<http://tv.somanuals.com>