

Dishmachine Maintenance Instructions

JPX-300 Series Door Gasket Kit Installation

The instructions provided here are for maintenance personnel only. Unauthorized persons should not attempt any of the steps contained in these instructions.

Warning: many of the instructions and steps within this document require the use of tools. Only authorized personnel should ever perform any maintenance procedure on the dishmachine!

PREPARATION

1. Power must be shut off to the unit at the service breaker. Tag or lock out the service breaker to prevent accidental or unauthorized energizing of the machine.
2. Ensure that incoming water to the machine is shut off.
3. The unit must be drained completely with the drain stopper removed (if applicable).
4. Remove any and all access covers.

TOOLS REQUIRED

The following tools may be needed to perform this maintenance evolution:

1. Phillipshead Screwdriver

TIME REQUIRED

It is estimated that it will take (1) person sixty minutes to perform this task, not including all of the items indicated in the section entitled "PREPARATION".

IMPORTANT NOTES

1. Read these instructions thoroughly before attempting this maintenance task. Become familiar with the parts and what actions need to be taken. This will save time in the long run!

1. Using the phillipshead screwdriver, removed the kickpanel. Be careful not to pull out any gauges that may be connected to the panel.
2. Ensure that the surface of the dishmachine is clean and free of any chemical residues.

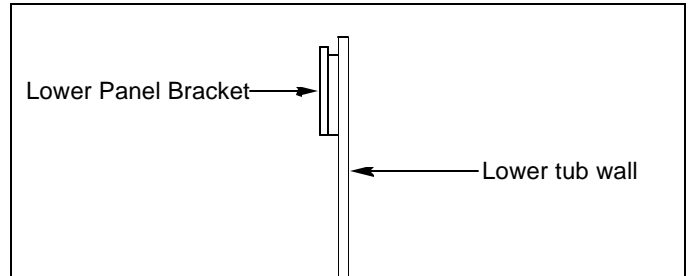

Placing the lower seal

3. Place the Lower Panel Bracket assembly on the unit, ensuring it is 1/16" below the lip of the tub. Press firmly to ensure proper placement.

4. Open the machine door to expose the labyrinth seal. Ensure it is free of chemical residues and debris.

5. Insert the door gasket into the top of the labyrinth seal, ensuring that the rounded edge is facing inward and the flat edge is facing the bottom. Some of the gasket will hang over the edge of the labyrinth seal; it must be folded over and under the seal.

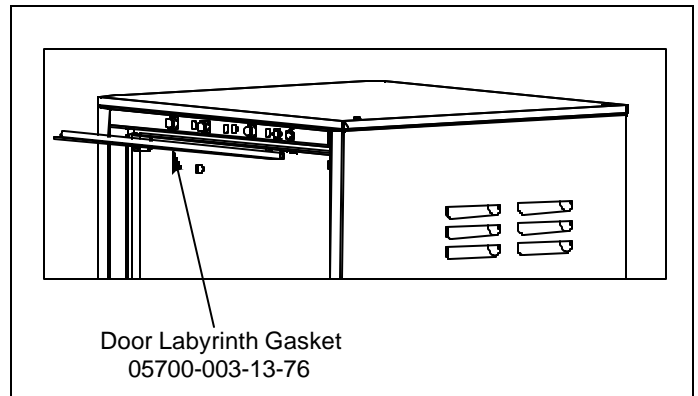

Installing the upper door gasket

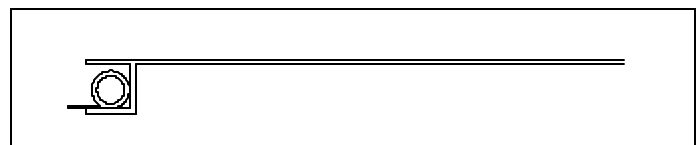

Side profile showing placement of "P" gasket

STEPS

6. Take the Door Labyrinth Grommet and slide it over the portion of the door gasket that is hanging over the seal lip.

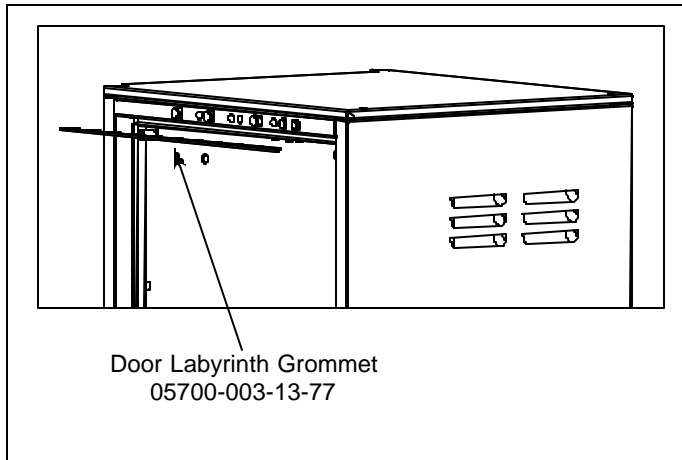

Installing the door labyrinth grommet

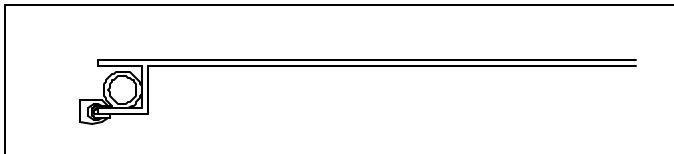

Side profile showing placement of door labyrinth grommet

7. Place the Splash Shield assembly inside the tub, centered on the door. The taped edge goes against the top of the tub so that the 1.25" lip hangs down. Position 1/2" from the backside of the labyrinth.

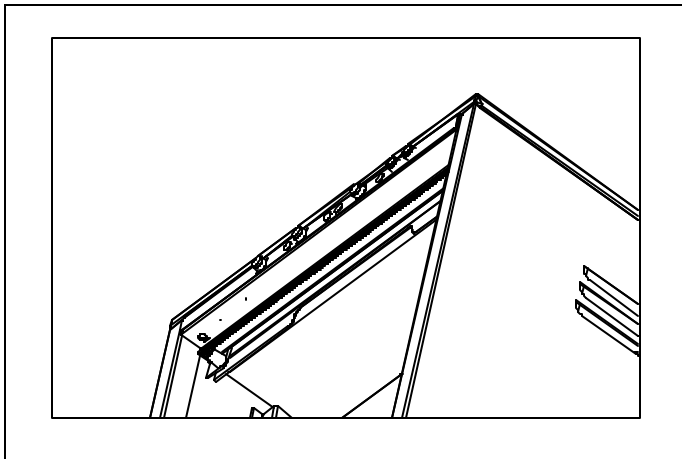

Positioning the Splash Shield inside the tub

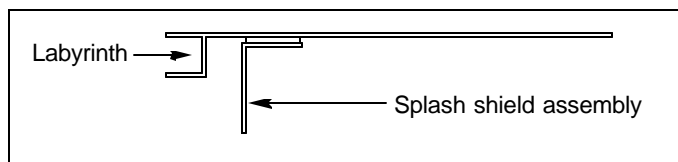

Placement of the splash shield assembly

AFTER MAINTENANCE ACTIONS

Run the machine through several cycles to ensure that the gasket is sealing properly.

SPECIAL NOTES

Work performed on Jackson dishmachines by unauthorized or unqualified personnel may void the warranty. Before beginning this or any other maintenance evolution on a unit under warranty, you should contact a certified Jackson technician or Jackson Technical Service. You can find a list of qualified service agencies in the back of you unit's installation manual.

SPECIAL PARTS

None.

CONTACT INFORMATION

Jackson MSC Inc. provides technical support for all of the dishmachines detailed in this manual. We strongly recommend that you refer to this manual before making a call to our technical support staff. Please have this manual with you when you call so that our staff can refer you, if necessary, to the proper page. Technical support is available from 8:00 a.m. to 5:00 p.m. (EST), Monday through Friday. Technical support is not available on holidays. Contact technical support toll free at 1-888-800-5672. Please remember that technical support is available for service personnel only.

Free Manuals Download Website

<http://myh66.com>

<http://usermanuals.us>

<http://www.somanuals.com>

<http://www.4manuals.cc>

<http://www.manual-lib.com>

<http://www.404manual.com>

<http://www.luxmanual.com>

<http://aubethermostatmanual.com>

Golf course search by state

<http://golfingnear.com>

Email search by domain

<http://emailbydomain.com>

Auto manuals search

<http://auto.somanuals.com>

TV manuals search

<http://tv.somanuals.com>