

Video-208PCI Series





nVIDIA GeForce4™ MX4000

User's Manual

Version 3.00

Copyright © 2009 Jaton Corporation, USA

Contents

INTRODUCTION.....	4
FEATURES	5
PCI BUS INTERFACE.....	5
GRAPHICS PROCESSOR UNIT (GPU).....	5
PERFORMANCE	5
COMPATIBILITY	6
HDTV/DVD PLAYBACK	6
SYSTEM REQUIREMENT.....	7
CHECK LIST	7
HARDWARE DESCRIPTION	8
HARDWARE INSTALLATION	12
INSTALLATION PROCEDURES	12
STEPS:	12
SOFTWARE INSTALLATION.....	14
 WINDOWS® 98 DRIVER INSTALLATION	14
 WINDOWS® ME DRIVE INSTALLATION	19
 MICROSOFT WINDOWS® NT™4.0.....	24
 WINDOWS® 2000 DRIVER INSTALLATION	29
 WINDOWS® XP DRIVER INSTALLATION	33
TECHNICAL ASSISTANCE	37

FREQUENTLY ASKED QUESTIONS (FAQ)	37
PINOUT AND SYNC FREQUENCIES.....	39
ANALOG COLOR DISPLAY PINOUTS (DB 15)	39
CONVERSION TABLE: PIN ADAPTERS	39
9-TO-15 PIN CONVERSION TABLE.....	40
TECHNICAL SUPPORT	40
LIMITED WARRANTY.	44
OTHER LIMITS.	44
EXCLUSIVE OBLIGATION.....	45
OTHER STATEMENTS.	45
TERMS AND CONDITIONS.	45
SERVICES AGREEMENT:	46
ENTIRE OBLIGATION.	46
REDUCING WARRANTY CLAIM REJECTIONS.	47

Introduction

The Video-208PCI Series video accelerators are excellent 2D/3D multimedia video adapters for PCI local bus desktop PCs'. Based on nVIDIA GeForce4 MX4000 core technology, built-in with 64MB / 128MB DDR memory module and these video cards will provide multiple display outputs onboard for TV-Out (Analog and Digital) or Dual RGB out (Twin) as options.

As the previously core technology from nVIDIA, the GeForce4™ MX4000 Graphics Processing Unit (GPU) shakes up the gaming industry with its extremely performance, unusual visual effects, and speedy frame rates-injecting life into the artificial world of computer-generated graphics.

The significant enhancement is the new high quality image control. The nVIDIA GeForce4™MX GPU has added two more rendering pipelines and the DirectX 8-compliant T&L unit into its graphic engine, which enables the maximum flexibility and high quality 4Xs mode control capabilities; gathered with the data bus Double Data Rate RAM (DDR) circuit, the PC users can ultimately enjoy the virtual environment of 3D scenes, and ambiance textures appear photo-realistic and custom lighting heightens at a highest resolution with astonishingly fast frame refresh rate.

Another feature of the Video-208PCI Series is the video accelerator, which integrates the HDVP (High Definition Video Processor) and DVD (Digital Versa Display) for video playback with higher definitions at greatly increased frame rates.

A leverage of the combination of hardware and software technology, nVIDIA GeForce4™ MX GPU will provide many of the new features and benefits you look for in your desktop computing as well as the best performance, combining usual quality and exceeding crisp resolution. With all of this, the Video-208PCI Series video cards bring a new level of graphics accomplishment and flexibility to the mainstream desktop PC market!

Features

PCI Bus Interface

- PCI Bus mastering compatible
- PCI 2.2 compliance

Graphics Processor Unit (GPU)

- 256-bit graphics engine
- 64MB / 128MB DDR memory access bus.
- Integrated dual 270 MHz RAMDACs drives CRT display
- 2 dual 128bit pixel pipelines rendering
- Surface engine for high-order surfaces and patches
- Programmable Vertex Shader
- Programmable Pixel Shader
- HRAA - high - resolution anti-aliasing
- Integrated hardware transform engine
- Integrated hardware lighting engine
- DirectX® and S3TC® texture compression
- Dual cube environment mapping capability
- Hardware accelerated real-time shadows

Performance

- Up to 1.1billion AA samples per second fill rate
- Up to 8.0 GB/sec memory bandwidth
- Up to 34 Million triangles/sec.
- True, reflective bump mapping

- High-performance 2D rendering engine
- API support - DirectX® 8.1 and lower

Compatibility

- nVIDIA Unified Driver Architecture
- Industry's first fully compliant professional OpenGL 1.3 support for Windows® operating systems
- Windows® 98, Windows® Me, Windows® NT™ 4.0, Windows® 2000, and Windows® XP

HDTV/DVD Playback

- High-Definition Video Processor (HDVP) for full-screen, full-frame video playback of HDTV and DVD resolutions
- Independent hardware color controls for video overlay
- Hardware color space conversion (YUV 4:2:2 and 4:2:0)
- Motion compensation
- 5-tap horizontal by 3-tap vertical filtering
- Per-pixel color keying
- Multiple video windows with hardware Color Space Conversion and filtering

System Requirement

- Intel Pentium® II, III or P4, or compatible system with PCI Bus Extension Slot
- CD-ROM drive, Double speed or faster
- Hard Drive with at least 100MB Free space
- MS Windows® 98/Me/NT 4.0/2000/XP operating systems

Check List

- Video-208PCI-64TV, Video-208PCI-64Twin, Video-208PCI-128TV or Video-208PCI-128Twin Multimedia accelerator
- Converter cable – converts MD-9pin to DB-15 VGA (*low profile Dual RGB VGA only*)
- Software & Documents CD
- Quick Start Guide (Printed)

Hardware Description

Video-208PCI TV series

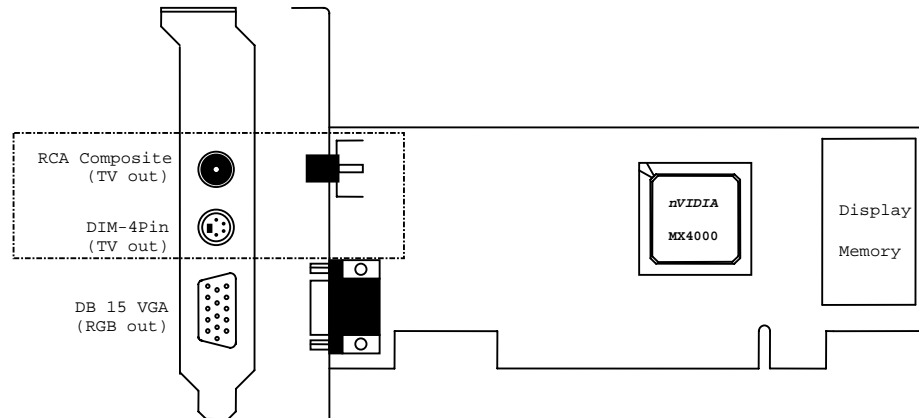

Product / PCB revision / Size			Core Chipset	Memory	
				/ Size	
Video-208PCI-64TV	82208N	W 6.25"x H 2.45"	nVIDIA GeForce4 MX4000	8M*16 DDR X 4	64MB
Video-208PCI-64TV	82208N	W 6.25"x H 2.45"	nVIDIA GeForce4 MX4000	16M*16 DDR X 2	64MB
Video-208PCI-128TV	82208N	W 6.25"x H 2.45"	nVIDIA GeForce4 MX4000	16M*16 DDR X 4	128MB

Special Bracket(s) Alternative			
P203	DB 15 VGA + MD 4 Pin + RCA Composite	L = 3.118" , W = 0.725"	For low profile PC use only

-Low profile PC system brackets only available for PCB revision mentioned above.

Video-208PCI Twin series

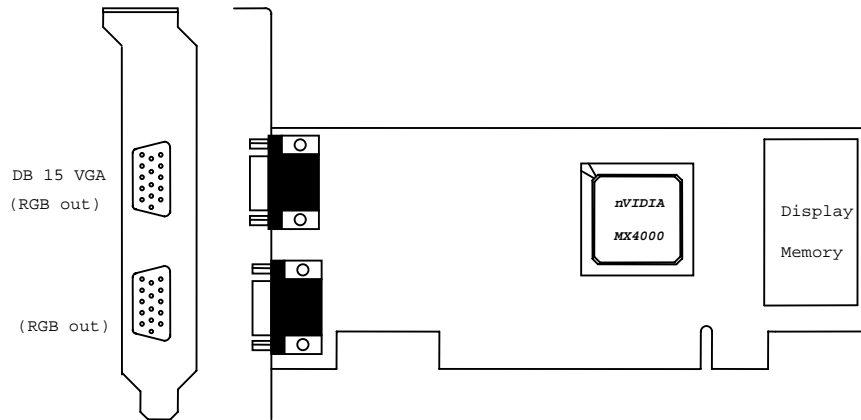

Low profile Dual RGB Out

Note: Low profile VGA (Dual RGB) only available for PCB revision 82208M/V2 (below)

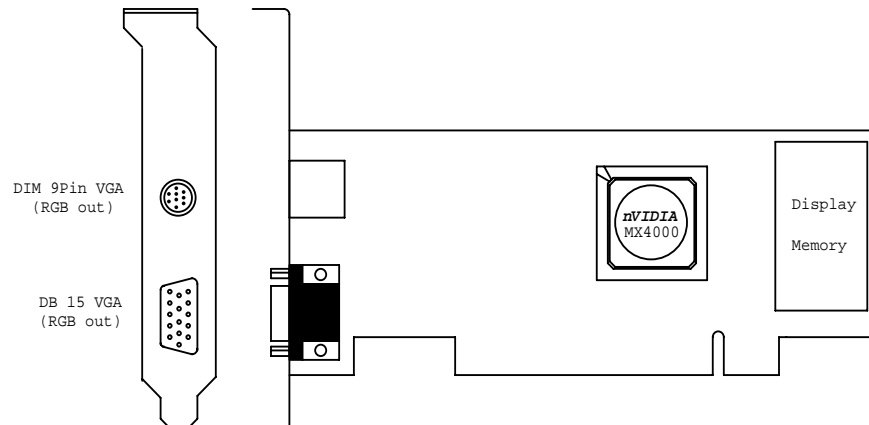

	Product / PCB revision / Size		Core Chipset	Memory	
				/ Size	
Video-208PCI-64Twin	82208M/V1	W 6.25"x H 2.6"	nVIDIA GeForce4 MX4000	8M*16 DDR X 4	64MB
Video-208PCI-64Twin	82208M/V1	W 6.25"x H 2.6"	nVIDIA GeForce4 MX4000	16M*16 DDR X 2	64MB
Video-208PCI-128Twin	82208M/V1	W 6.25"x H 2.6"	nVIDIA GeForce4 MX4000	16M*16 DDR X 4	128MB
Video-208PCI-64Twin	82208M/V2*	W 6.25"x H 2.6"	nVIDIA GeForce4 MX4000	8M*16 DDR X 4	64MB
Video-208PCI-64Twin	82208M/V2*	W 6.25"x H 2.6"	nVIDIA GeForce4 MX4000	16M*16 DDR X 2	64MB
Video-208PCI-128Twin	82208M/V2*	W 6.25"x H 2.6"	nVIDIA GeForce4 MX4000	16M*16 DDR X 4	128MB

*Has option for low profile Dual RGB.

Special Bracket(s) Alternative			
P257	DB 15 VGA + MD 9 Pin (Dual RGB)	L = 3.118" , W = 0.725"	For low profile PC use only

-Low profile PC system bracket (Dual RGB) only available for PCB revision **82208M/V2** mentioned above.

Output Connections (TV-Out)

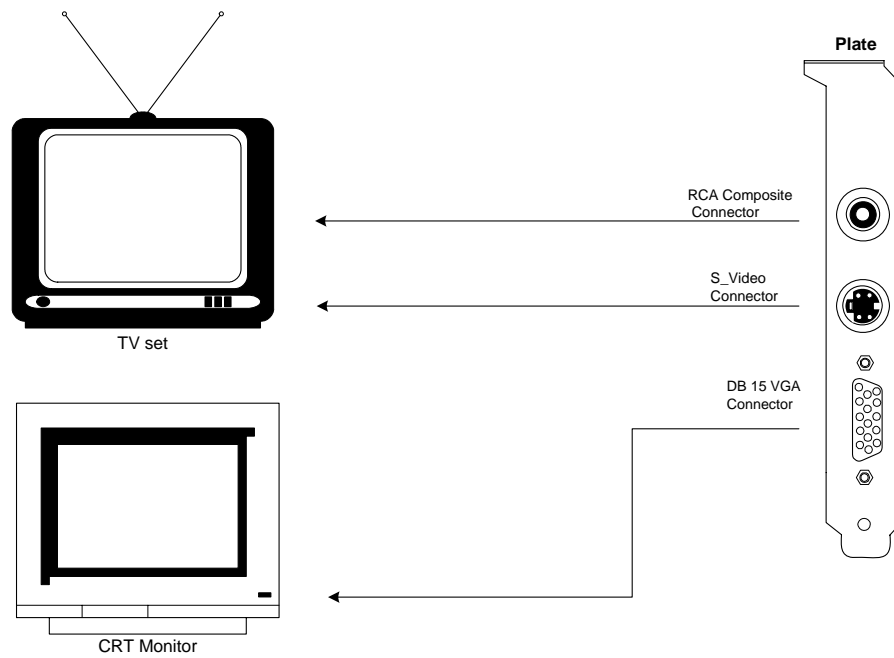

Output Connections (Dual RGB)

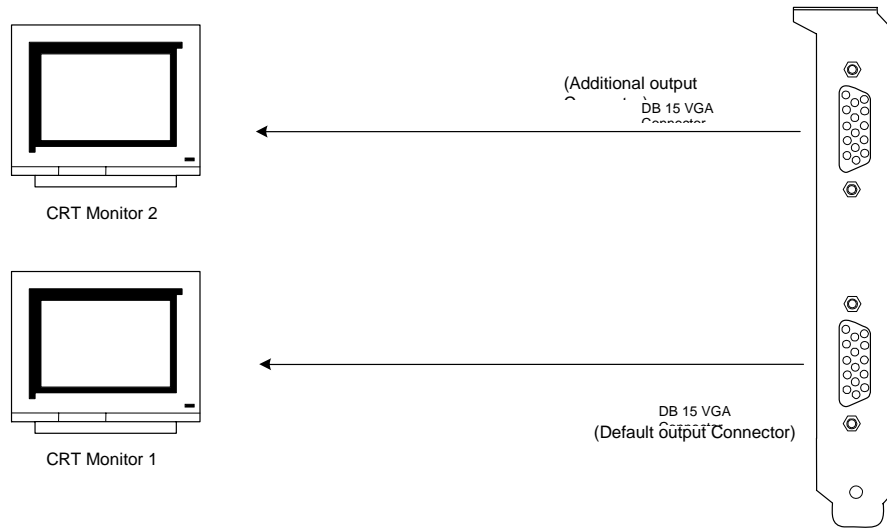

Low profile Dual RGB Out

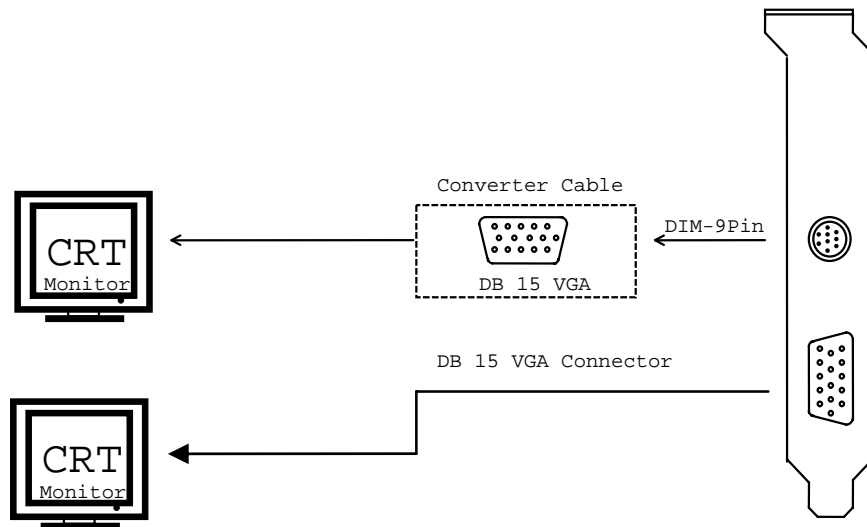

Hardware Installation

Installation Procedures

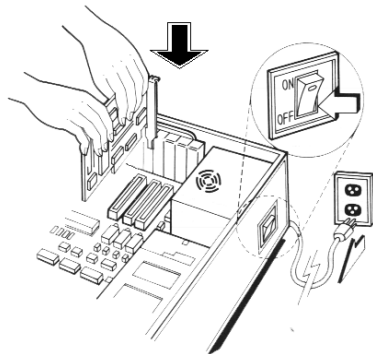

!! WARNING !!

Discharge static electricity by touching the **GROUND** such as metal part of your case connected with good power ground before you handle the electronic circuit boards.

The manufacturer assumes no liability for any damage, caused directly or indirectly, by improper installation of any components by unauthorized service personnel. If you do not feel comfortable performing the installation, consult with a qualified computer technician.

Steps:

1. Turn OFF all powers to your system, including any peripherals (printer, external drives, modem, etc.).
2. Disconnect the power cord and the monitor cable from the back of the computer.
3. Unfasten the cover mounting screws on your system and remove the system cover. Refer to your system user manual for instructions to determine the location of the mounting screws.
4. Remove the retaining screw that holds the slot cover in place. Slide the slot cover out and put the screw aside (you will need it to secure the adapter).
5. To install the adapter in PCI expansion slot, carefully line up the gold-fingered edge connector on the adapter directly above the expansion slot connector on the motherboard. Then press the adapter into place, completely. Use the (remaining) screw you removed to secure the adapter-retaining bracket in place.

6. Replace the computer cover. Secure the cover with the mounting screws you removed in Step 3.

You have now completed the installation of your new graphics adapter on your system.



Upgrade Steps:

To add or change your video adapter to an existing system, you may precede a few steps before you install the new hardware and software (video display driver).

The following are some of the considerations:

1. To change a new adapter, please remove the existing video driver, or replace it with a SVGA driver from Windows®98/Me system before you remove the existing hardware.
2. To add a new adapter, ensure the mainboard that has available IRQ for new devices, and there is no conflict between the others.
3. If you try adding this video adapter to an ALL-IN-ONE mainboard (which video port built-in already), then you must disable that port first. Otherwise, that will be a problem for the new video adapter setup.
4. The driver installation for system upgrade is as the same as below, if an error occurs when you proceed with step 1, 2 or 3, please consult with your system's dealer or the existing hardware manufacturer support.

Software Installation

Windows® 98 Driver Installation

Upgrade video adapter to an existing system. (Windows has been pre-loaded)

1. Select [Next] to install Standard VGA Graphics Adapter at Add New Hardware Wizard screen.
2. Check [Search for the best driver for your device] then select [Next].
3. Insert the software's CD.
4. Check [Specify a location:], under that enter D:\Win9x, then select [Next].
5. Select [Next] to install "Video-208PCI Series, NVIDIA GeForce4 MX4000" driver.
6. Select [Finish] to restart the computer.

To a new system:

1. SELECT the "Display" icon from control panel and then tab on "Settings" screen.
1. Select **Advanced** at selection bar.
2. Click on **Adapter** tab screen.
3. Click the **Change** button.
4. Click the **Next** button at Update Device Driver Wizard.
5. Click the **Next** button.
6. Select **Display a list of the drivers in a specific location...** Then click the **Next**.

7. Insert the Software's CD then Click the **Have Disk** button.
8. Under **Copy manufacturer's file from** statement enter **D:\Win9x**, click the **OK** button. (Where D is the letter of your CD ROM drive, typically, D or E Drives, etc.)
9. Select "Video-208PCI Series, NVIDIA GeForce4 MX 4000", then Click the **OK** button.
10. Click the **Next** button.
11. Click the **Finish** button.
12. Click the **Close** button.
13. Click **Close** at the Display Properties screen.
14. Click the **Yes** button next to restart computer.

InstallShield® Program:

Since the Microsoft InstallShield® program has been added into our software's CD, the Display Driver Installation and its procedures are much easier for users to run with Windows® 95/98/Me operating systems. When you power-up the computer and boot-up to Windows, the Plug-and-Play detects new hardware and it pops-up install wizard. Do Not **[Cancel]** because you must place a default display setting from Microsoft Windows for your video adapter, then restart the Windows. After the desktop is loaded completely, insert the software's CD into CD ROM drive and proceed with the display driver installation which is provided by the hardware manufacturer.



Autorun feature brings-up the “Welcome Screen”, and you may point to “display driver”, then press on it.

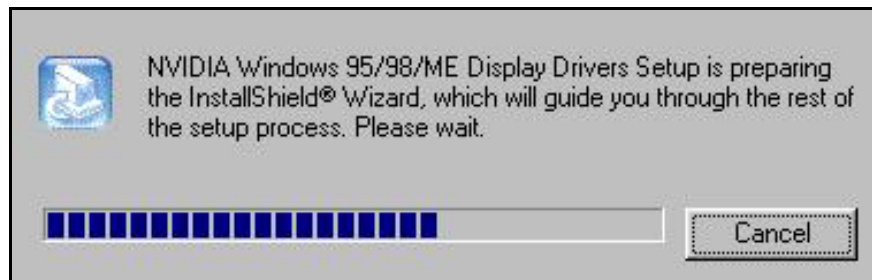

1. Microsoft InstallShield® Wizard has start loading its setup process; please wait until it is finished.



2. Click on "Next" to continue the process.

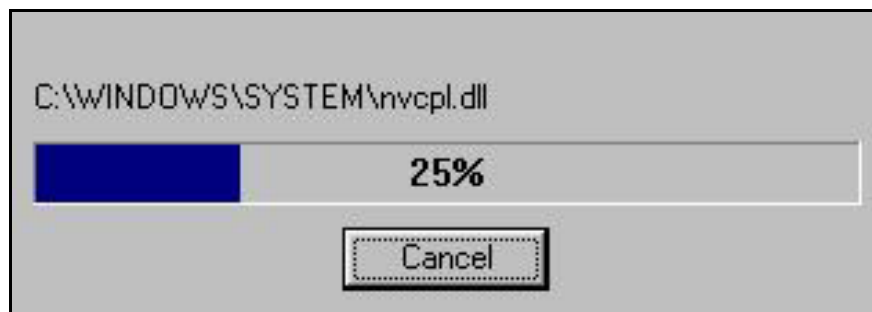

3. Windows system will copy all driver files from source media to your local hard disk, please wait until the process has completed.



4. Click on "Finish" to restart your computer, the new display driver will be in place after Windows boots-up.

Windows® Me Drive Installation

Upgrade video adapter to an existing system. (Windows has been pre-loaded)

1. Select [Next] to install Standard VGA Graphics Adapter at Add New Hardware Wizard screen.
2. Check [Search for the best driver for your device] then select [Next]
3. Insert the software's CD.
4. Check [Specify a location:], under that enter D:\Win9x, then select [Next].
5. Select [Next] to install "Video-208PCI Series, NVIDIA GeForce4 MX4000" driver.
6. Select [Finish] to restart the computer.

To a new system:

1. SELECT the "Display" icon from control panel and then tab on "Settings" screen.
2. Select **Advanced** at selection bar.
3. Click on **Adapter** tab.
4. Click the **Change** button at Adapter Screen
5. Click [Specify the location of the driver (Advanced)] then check Next.
6. Insert Software's CD to CD ROM.
7. Click Specify a location then under **Copy manufacturer's file from** statement enter **D:\Win9x**, click the **Next** button.(Where D is the letter of your CD ROM drive, typically, D or E drives, etc.)

8. Click Next to install “**Video-208PCI Series, NVIDIA GeForce4 MX4000**” driver.
9. Click the **Finish** button.
10. Click the **Yes** button next to restart computer.

InstallShield® Program:

Since the Microsoft InstallShield® program has been added into our software’s CD, the Display Driver Installation and its procedures are much easier for users to run with Windows® 95/98/Me operating systems. When you power-up the computer and boot-up to Windows, the Plug-and-Play detects new hardware and it pops-up install wizard. Do Not **[Cancel]** because you must place a default display setting from Microsoft Windows for your video adapter, then restart the Windows. After the desktop is loaded completely, insert the software’s CD into CD ROM drive and proceed to the display driver installation which provided from the hardware manufacturer.



Autorun feature brings-up the “Welcome Screen”, and you may point to “display driver”, then press on it.

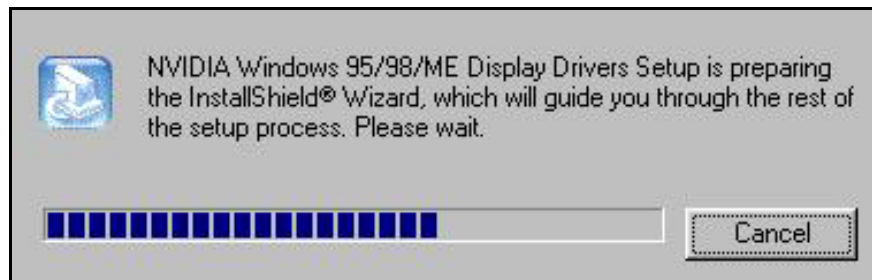

1. Microsoft InstallShield® Wizard has start loading its setup process; please wait until it is finished.



2. Click on "Next" to continue the process.

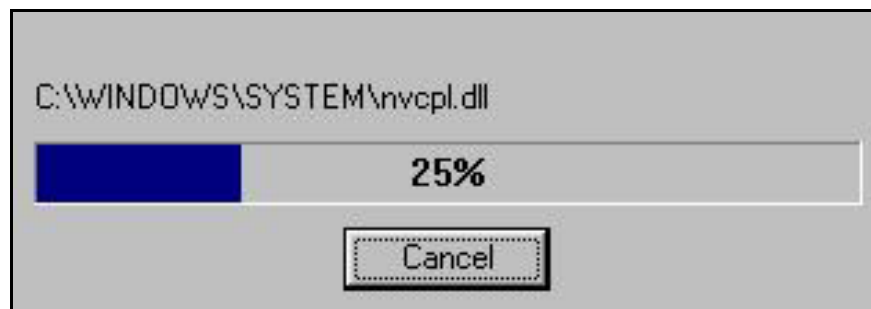

3. Windows system will copy all driver files from source media to your local hard disk, please wait until the process has completed.



4. Click on “Finish” to restart your computer, the new display driver will be in place after Windows boots-up.

Microsoft Windows® NT™4.0

The procedure of display driver installation requires setup with service pack 6 (Microsoft® Windows NT™4.0) first. After your windows desktop is loaded with service pack 6, you may insert the software CD into CD ROM drive and follow the install steps below:

Upgrade video adapter to an existing system. (Windows has been pre-loaded)

1. SELECT the “Display” icon in control panel and then SELECT the “Settings” page.
2. SELECT “Display Type...” button in the “Settings” page.
3. SELECT “Change...” button from the Adapter type section.
4. SELECT “Have Disk...” button from the Change Display page.
5. Windows NT 4.0 prompt you for the location where those files for video driver. INPUT the path or unfold with “X:\Winnt4\”. (X: is the CD ROM drive where the Software & Documents CD has been inserted.)
6. If the driver “**Video-208PCI Series, NVIDIA GeForce4 MX4000**” is listed under the Display list, SELECT the “OK” button to continue.
7. Once the driver files are copied, RESTART Microsoft Windows NT 4.0 for the changes to take effect.
8. SELECT the desired color palette (the number of colors), desktop area (resolution), and refresh frequency in the settings page of Display Properties and then SELECT the “Test” button in the same page to determine whether your

selection works properly. SELECT “Apply” to active the selected mode.

InstallShield® Program:

Since the Microsoft InstallShield® program has been added into our software’s CD, the Display Driver Installation and its procedures are much easier for users to run with Windows®NT™ operating system. After the desktop is loaded with service pack 6, insert the software’s CD into CD ROM drive and proceed with the display driver installation, which is provided by the hardware manufacturer.



Autorun feature brings-up the “Welcome Screen”, and you may point to “display driver”, then press on it.

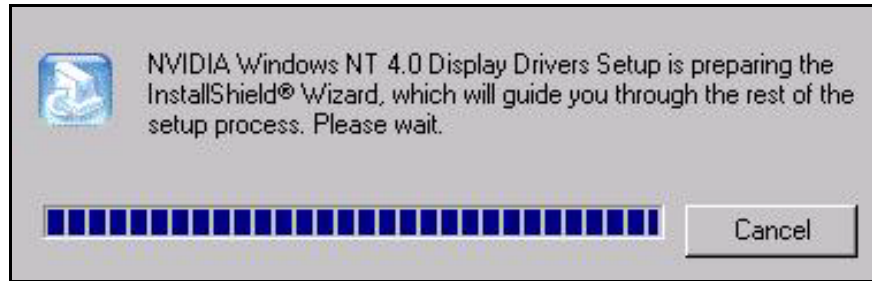

1. Microsoft InstallShield® Wizard has preparing its setup, please wait until it completes.



2. Click on "Next" to continue.

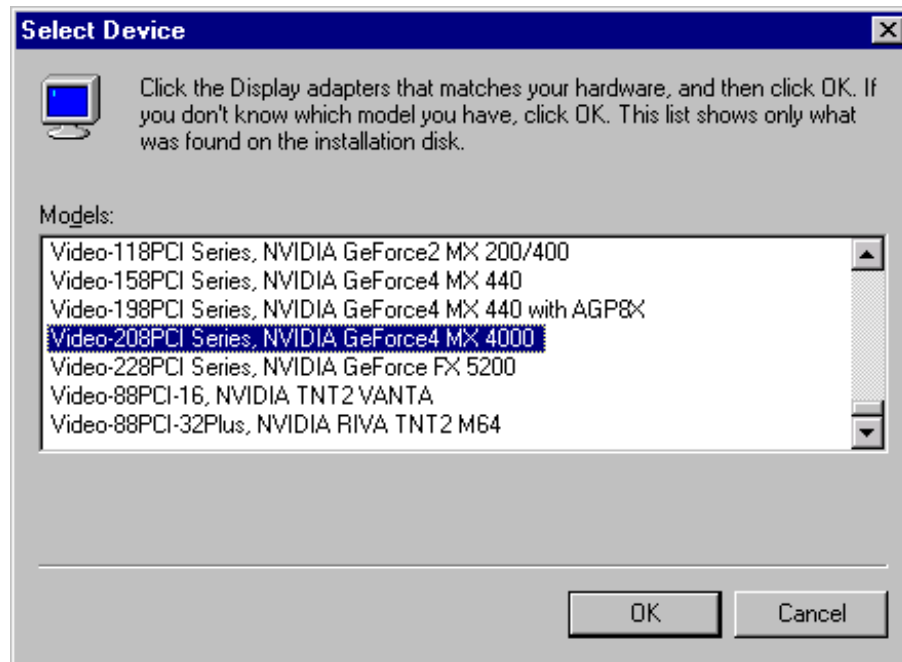

3. Scroll down and Select on the “Video-208PCI Series, NVIDIA GeForce4 MX4000”, then click on “OK” for next screen.



4. Windows system will transmit all driver files from source media to your local hard disk, please wait until the process has completed.



5. Click on "Finish" to restart your computer, the new display driver will be in place after Windows boots-up.

Windows® 2000 Driver Installation

Upgrade video adapter to an existing system. (Windows has been pre-loaded)

1. Select [Next] at Found New Hardware Wizard.
2. Check [Search for a suitable driver for my device (recommended)] then select [Next].
3. Insert the Software's CD.
4. Check [Specify a location:]
5. Under [Copy manufacturer's files from:] enter D:\WIN2K&XP, where D is your CD_ROM drive. Then click on [OK].
6. Select [Next] to install "Video-208PCI Series, NVIDIA GeForce4 MX4000" driver.
7. Select [Finish] to restart the computer.

InstallShield® Program:

Microsoft Windows®2000 detects this new hardware and places the appropriate display driver from its system folder automatically - it doesn't matter if you have added a new driver or changed the existing one. To maximize the video board acceleration and increase its performance, you may install the manufacturer display driver as follows:



Autorun feature brings-up the “Welcome Screen”, and you may point to “display driver”, then press on it.

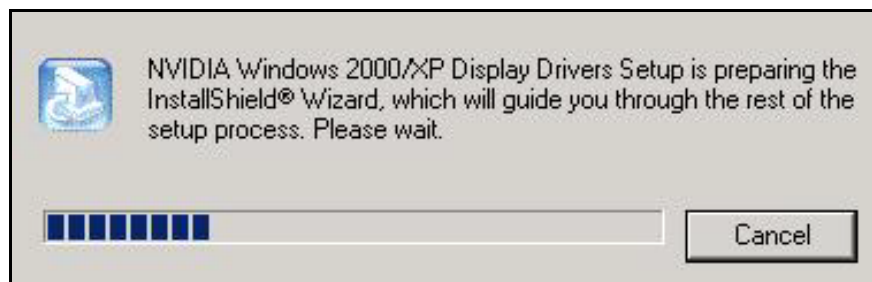

1. Microsoft InstallShield® Wizard has start loading its setup process, please wait until it has completed.

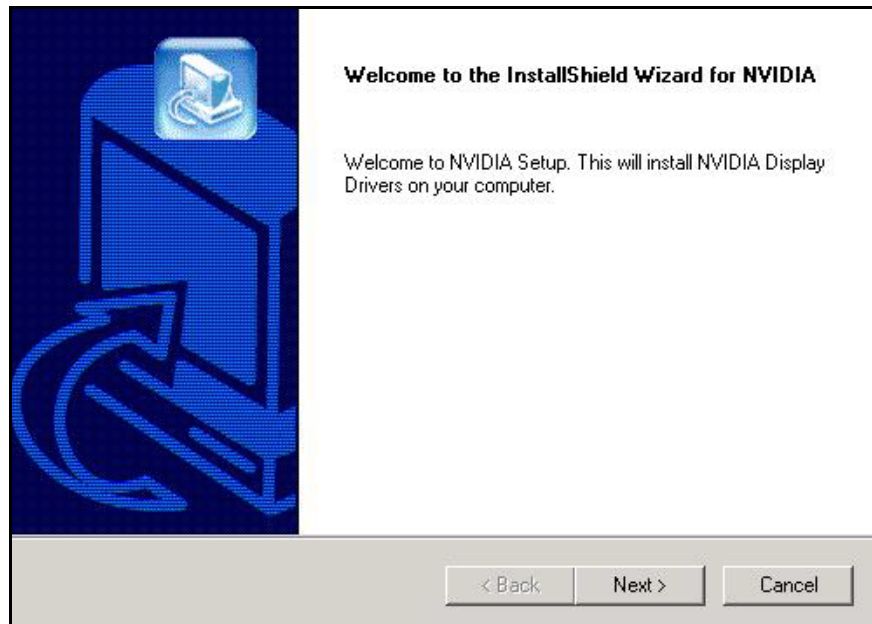

2. Click on "Next" to continue the process.



3. Click on "Yes" to continue the installation. Otherwise, you may terminate the process by click on "No".

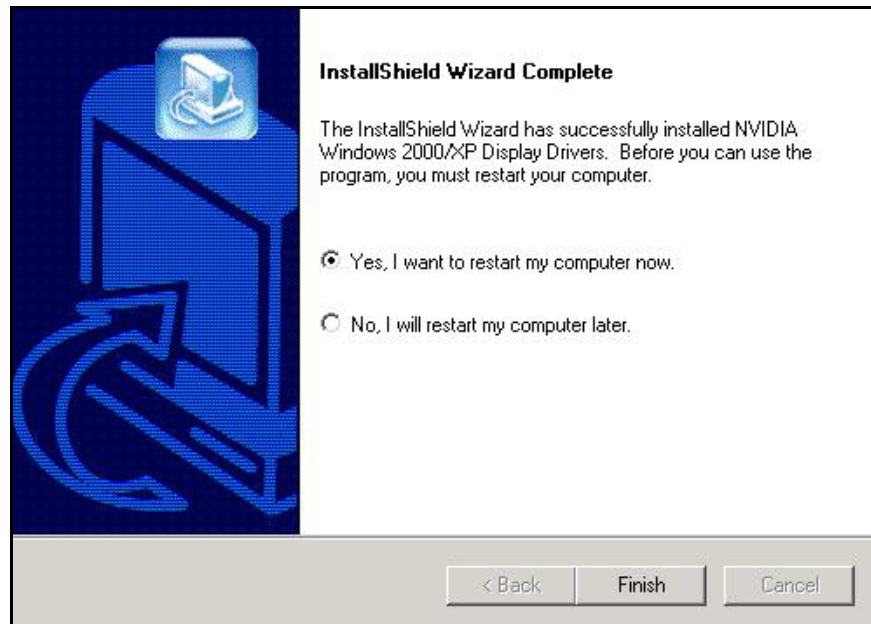

4. Click on "Finish" to restart your computer, the new display driver will be in place after Windows boots-up.

Windows® XP Driver Installation

Upgrade video adapter to an existing system. (Windows has been pre-loaded)

1. Select [Next] at Found New Hardware Wizard.
2. Check [Search for a suitable driver for my device (recommended)] then select [Next].
3. Insert the Software's CD.
4. Check [Specify a location:]
5. Under [Copy manufacturer's files from:] enter D:\WIN2K&XP, where D is your CD_ROM drive. Then click on [OK].
6. Select [Next] to install "Video-208PCI Series, NVIDIA GeForce4 MX4000" driver.
7. Select [Finish] to restart the computer.

InstallShield® Program:

Microsoft Windows® XP detects this new hardware and places the appropriate display driver from its system folder automatically - it doesn't matter if you have added a new driver or changed the existing one. To maximize the video board acceleration and increase its performance, you may install the manufacturer display driver as follows:



Autorun feature brings-up the “Welcome Screen”, and you may point to “display driver”, then press on it.

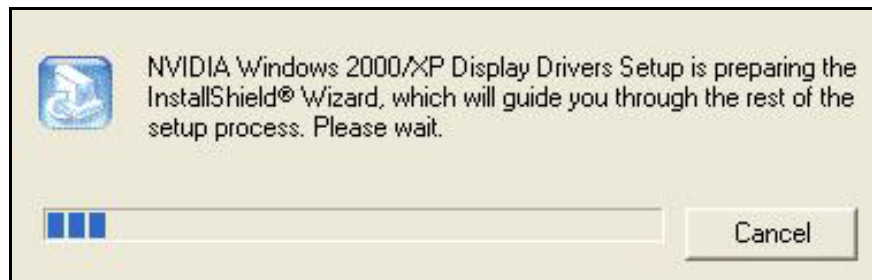

1. Microsoft InstallShield® Wizard has start loading its setup process, please wait until it has completed.

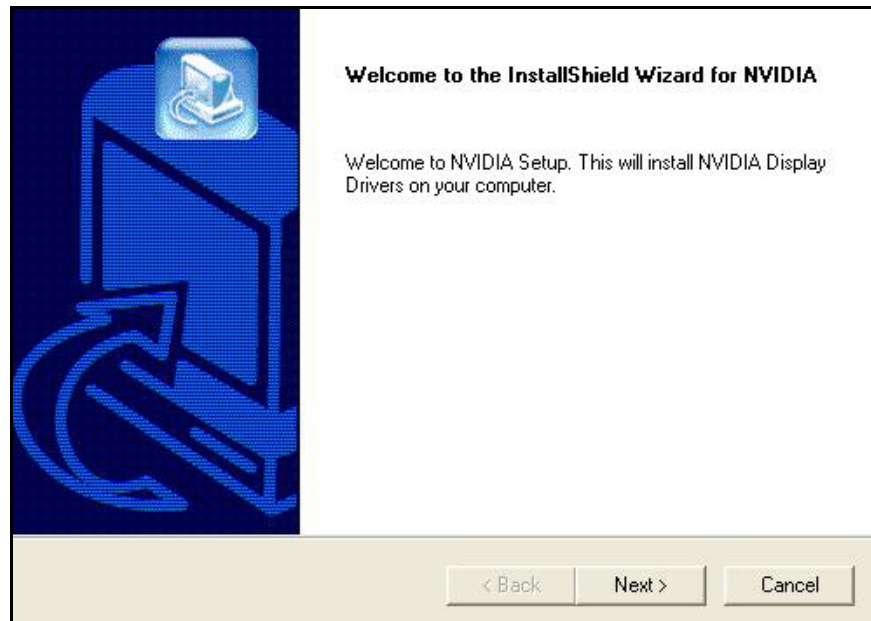

2. Click on "Next" to continue the process.



3. Click on "Continue Anyway" to complete the installation. Otherwise, you will terminate the process at this time.

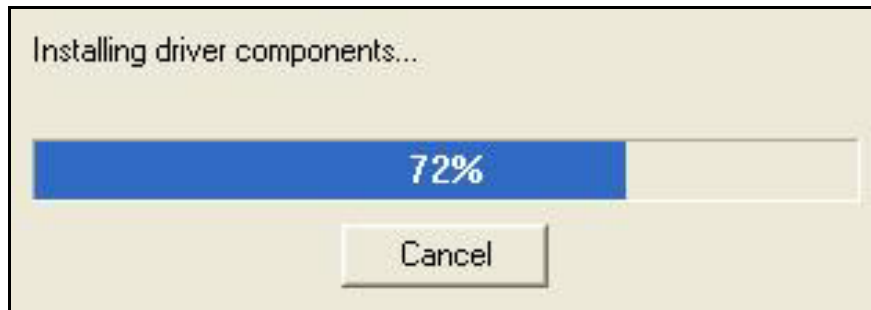

4. Windows system will transmit all driver files from source media to your local hard disk, please wait until the process has completed.



5. Click on "Finish" to restart your computer, the new display driver will be in place after Windows boots-up.

Technical Assistance

Frequently Asked Questions (FAQ)

Q1 Why do we need 3D graphics capability in our PC?

Answer

3D technology is becoming increasingly important (and common) not only in games, but also in other applications such as VRML, which allows 3D scene descriptions in Web applications. 3D technology is used for image editing, modeling, and an increasing number of these are found in home and business applications. In games, as well as other applications, 3D acceleration not only allows better visual qualities and more realistic scenery attributes than software alone, but it also allows a higher frame rate, which translates into a more interactive experience for the end user.

Q2 What does "Rendering Engine" mean?

Answer

"Rendering Engine" generically applies to the part of the graphics engine that draws 3D primitives, usually triangles. In most implementations, the rendering engine is responsible for interpolation of edges and "filling in" the triangle.

Q3 What does the set-up engine do in a graphics controller?

Answer

A set-up engine allows drivers to pass triangles in the form of raw vertex information; whereas, most common designs force triangles to be pre-processed for the rendering engine in terms of delta values for edges, color, and texture.

Q4 Why does a 3D graphics chip need to have both a rendering engine and a setup engine?

Answer

Any "3D application", a game, VRML, or modeling package, can benefit from 3D rendering. This is especially true of an application that uses texturing extensively, because texturing and texture filtering are very intensive operations at the pixel level in terms of CPU operations and demands for memory bandwidth. Without a set-up engine in a graphics controller, the CPU has to calculate the delta values for edges, color,

and textures; the drivers need to handle ten (10) times more extensive data. This results in slower 3D pipeline operations between the CPU and the graphics controller.

Q5 If we use powerful CPUs, such as a Pentium™ 200, can a standard 2D graphics card achieve 3D performance?

Answer

Yes and no. Software rendering can take advantage of "tricks" learned by force of necessity through years of trial and error. With such stratagems, the speed of software rendering for simple scenes can approach that of low-level hardware 3D rendering. On the other hand, as scenes become more complex (or frame sizes become larger), there are conflicts between using the CPU for high-level game logic, geometry, lighting, and rendering, all of which increase their demands. No current CPU or system can perform advanced quality-enhancements (bilinear filtering and alpha blending) in real time. Even general case texture mapping with RGB lighting is too much for the current CPU generation.

Q6 What does "software 3D" mean?

Answer

Software 3D is generally used to mean using non-specific (2D) hardware in conjunction with the CPU to render for 3D applications. Some of these techniques allow usable 3D applications when high-powered and/or MMX™-equipped CPU's are employed along with special-case software optimization techniques. As stated above, SW 3D can achieve credible results with today's (software optimized) applications, but the rising popularity of good 3D hardware at the consumer price level is inexorably compelling the public to expect hardware level scene enhancements and frame rates.

Q7 What is "SGRAM"?

Answer

Synchronous Graphics Random Access Memory (SGRAM) is a new and improved type of memory, custom-designed for graphics use.

Q8 What is the advantage of as compared to ordinary DRAM?

Answer

SGRAM is now capable of running at much higher speeds than Fast Page Mode or EDO DRAM. Also, is able to execute a small number of frequently executed operations, such as buffer clears, specific to graphics applications, independently of the controller.

Pinout and Sync Frequencies

Analog Color Display Pinouts (DB 15)

PIN	FUNCTION
1	Red Video ¹
2	Green Video ¹
3	Blue Video ¹
4	Not Used
5	Ground
6	Red Return (ground)
7	Green Return (ground)
8	Blue Return (ground)
9	Vcc (+5v DDC Power)
10	Sync Return (ground)
11	Monitor ID (not used)
12	SDA (DDC support)
13	Horizontal Sync
14	Vertical Sync
15	SCL (DDC support)

Note: Analog monochrome type monitors use green video for all video input and ignore red and blue video.

Conversion Table: Pin Adapters

If you will be using a 9-to-15-pin adapter cable to link your 9-pin monitor connector to the 15-pin accelerator card connector, check Table carefully before you install the cable. The 9-to-15 pin adapter cables are available from a variety of sources, but they need to match the specifications in Table to work properly with your new card.

The adapter cable requires a D-shaped 9 pin female connector and a D-shaped 15 pin male connector.

9-to-15 Pin Conversion Table

9 PIN SIGNALS	PIN NO.	15 PIN SIGNALS	PIN NO.
Red	1	Red	1
Green	2	Green	2
Blue	3	Blue	3
Horz Sync	4	Horz Sync	13
Vert Sync	5	Vert Sync	14
Red Ground	6	Return Red	6
Green Ground	7	Return Green	7
Blue Ground	8	Return Blue	8
Sync Ground	9	Digital Ground	10
		Ground	5

Analog Video Signals

Black Level = 0 V

Full Intensity (White) Level = +0.7 V

Technical Support

In the event you have a technical problem with this product, please read the README files in the software CD_ROM. Updated drivers are available through Jaton Web site. Have following information handy when you contact technical support:

- Name of the product.
- Software Driver and Version.
- System Information, such as CPU speed, BIOS version, Monitor Specification, etc.
- Description of the problems including any error messages.

Telephone: (510) 933-8886 (Mon. - Fri. 9am-5pm PST)

FAX: (510) 933-8887

email: vgasupport@jaton.com

Website: www.jaton.com

How to Obtain Warranty Service

In the worldwide contact:

www.jaton.com

In United States contact:

Jaton Corporation.

Service Center

47677 Lakeview Blvd.,

Fremont, CA 94538

Tel: 510-933-8886

Fax: 510-933-8887

In Taiwan contact:

Jaton Technology Co., Ltd.

10F, NO.194, SEC.3, TA TUNG RD., HIS-CHIH,
TAIPEI, TAIWAN R.O.C.

Tel : 886-2-8647-1899

Fax : 886-2-8647-2679

In Australia contact:

Jaton Technology Pty, Ltd.

Unit 8, 41-49 Norcal Road,

Nunawading, Vic 3131 Australia

Tel: (Mel) 03 9873 3999 (Syd) 02 9476 8781

Fax 03 9873 3933

NOTICE

The information in this document is subject to change in order to improve reliability, design, or function without prior notice and does not represent a commitment on the part of the company. In no event will the company be liable for direct, indirect, special, incidental, or consequential damages arising out of the use or the inability to use the product or documentation, even if advised of the possibility of such damages. No part of this manual may be reproduced or transmitted in any form or by any means without the prior written permission of the company.

July 2003, Rev. A

FCC SHIELDED CABLE WARNING:

This equipment has been tested and found to comply with the limits for a Class B digital device, pursuant to Part 15 of the FCC Rules. Operation is subject to the following conditions: (1) this device may not cause harmful interference, and (2) this device must accept any interference received, including interference that may cause undesired operation,

“SHIELD INTERFERENCE CABLE (S) MUST BE USED ACCORDING TO FCC 15.27©.”

CAUTION:

Changes or modifications not expressly approved by the Manufacturer could void your authority to operate this equipment in accordance with FCC rules and regulations.

SOFTWARE LICENSE AGREEMENT:

The Company grants the customer a non-exclusive, non-transferable license to use the software in this package for internal use on a single computer system. No other license of any kind is granted to any part of the product or any of the intellectual property therein.

TRADEMARK AND COPYRIGHT:

This product incorporates copyright protection technology that is protected by method claims of certain U.S. patents and other intellectual property rights owned by Macrovision Corporation and other rights owners. Use of this copyright protection

technology must be authorized by Macrovision Corporation,
and is intended for home and other limited viewing used only
unless otherwise authorized by Macrovision Corporation.
Reverse engineering or disassembly is prohibited.

All Trademarks and Registered Trademarks belong to
respective owners.

©2009 Jatou Corporation. All rights reserved.

Limited Warranty

Manufacturer warrants that the products sold hereunder are free from defects in material and workmanship for a period of two (2) years from manufacturing date. This limited warranty applies only to the original purchaser of Jaton Product and is not transferable. This limited warranty does not apply if failure to the Product Registration, or over thirty (30) days from purchase (original invoice date). This Limited Warranty does not cover any incompatibilities due to the user's computer, hardware, software or any related system configuration in which the Jaton Products interfaces. Proof of purchase will be requiring before any consideration by Manufacturer occurs.

Other Limits

The forgoing is in lieu of all other warranties, expressed or implied. Including but not limited to the implied warranties of merchantability and fitness for a particular purpose. Manufacturer does not warrant against damages or defects arising out of improper or abnormal use of handling of the products; against defects or damages arising from improper installation (where installation is by persons other than Manufacturer), against defects in products or components not manufactured or installed by Manufacturer, or against damages result from non-manufacturer made products or components. This warranty does not apply if the Product has been damaged by accident, abuse, nor misuse. This warranty also does not apply to products upon which repairs have been affected or attempted by persons other than pursuant to written authorization by Manufacturer.

Exclusive Obligation

This warranty is exclusive. The sole and exclusive obligation of Manufacturer shall repair or replace the defective products in the manner and for the period provided above. Manufacturer shall not have any other obligation with respect to the Products or any part thereof, whether based on contract, tort, and strict liability or otherwise. Under no circumstances, whether based on this Limited Warranty or otherwise, Manufacturer shall not be liable for incidental, special, or consequential damage.

Other Statements

Manufacturer's employees or representatives' **ORAL OR OTHER WRITTEN STATEMENTS DO NOT CONSTITUTE WARRANTIES**, shall not be relied upon by Buyer, and is not a part of the contract for sale or this Limited Warranty.

Terms and Conditions

- Direct Jatón Customer:** This warranty applies only for a period of two (2) years from purchase date of Jatón original invoice.
- Reseller/ Vendor:** This warranty applies only for a period of two (2) years from manufacturing date.
- Registered User:** This warranty applies only for a period of two (2) years from purchase date and register within 30 days of purchase date from legal reseller.
- Others:** If the products do not conform to this Limited

Warranty (as herein above described), Manufacturer should charge services such as repair, replacement whether based on its costs. Shipping and installation of the replacement Products or replacement parts shall be at User's expense.

Services agreement:

- (1) All applicants shall complete a service request form from Manufacturer.
- (2) All returned checks will be charged a \$20.00 fee by Manufacturer.
- (3) All repair and replacement services allow 4-6 weeks from the date of receiving by Manufacturer.
- (4) All products without warranties require service processing fee \$20 (payment in advance), which is not refundable.

Entire Obligation

This Limited Warranty states the entire obligation of Manufacturer with respect to the Products. If any part of this Limited Warranty is determined to be void or illegal, the remainder shall remain in force and effect. Some states do not allow limitation of implied warranties, or exclusive or limitation on product incidental or consequential damages, so above limitation may not apply to you. This warranty gives you specific legal rights. You may have other rights, which may vary from state to state.

This warranty applies only to this product, and is governed by the law of the State of California.

Reducing Warranty Claim Rejections

To reduce the potential of incurring damages not covered by Manufacturers warranties, we strongly recommend the following:

- Read your manuals before installing peripherals and/or before making changes to the machine's configuration;
- Ask your dealer if there are any known problems with the system requirements or installation procedures for any add-on products that your are purchasing;
- Buy industry standard products where compatibility issue are more likely to surface;
- If you are unsure about installation for a new product, contact your dealer's service department.

We believe it is important for you to know and understand what your warranty coverage provides and what it does not.

We also want you to be aware that most hardware warranties only relate to the function of the hardware. In most cases, no assurances are given by the manufacturer that the hardware item will work in conjunction with any other hardware item. If a computer product is not working because it is not compatible with another product, or because it has not been properly installed and set-up, the manufacturer does not pay for

the service time. To help avoid these inconveniences, contact a professional consultant that one can help you determine the possibility of incompatibility issue before you purchase add-on or accessories.

Warranty Service Use Only

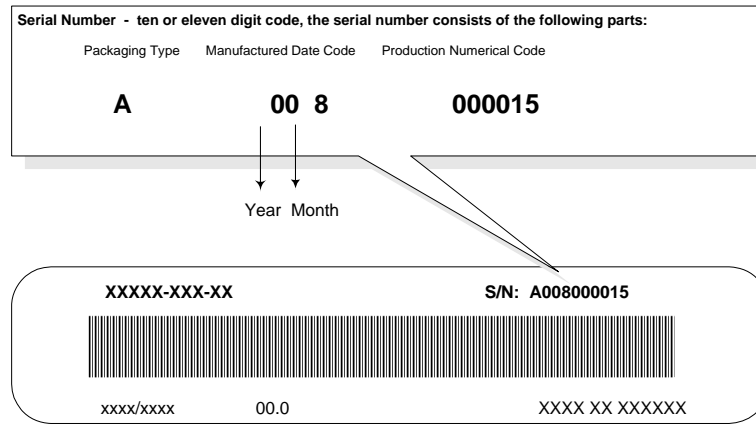

Product Label and Manufactured Date Code

Free Manuals Download Website

<http://myh66.com>

<http://usermanuals.us>

<http://www.somanuals.com>

<http://www.4manuals.cc>

<http://www.manual-lib.com>

<http://www.404manual.com>

<http://www.luxmanual.com>

<http://aubethermostatmanual.com>

Golf course search by state

<http://golfingnear.com>

Email search by domain

<http://emailbydomain.com>

Auto manuals search

<http://auto.somanuals.com>

TV manuals search

<http://tv.somanuals.com>