

JENN-AIR

Use and Care Manual

30" Expressions®

Convection Wall Oven

Models W30400, WM30460, WW30430

W30400S, WW30430S

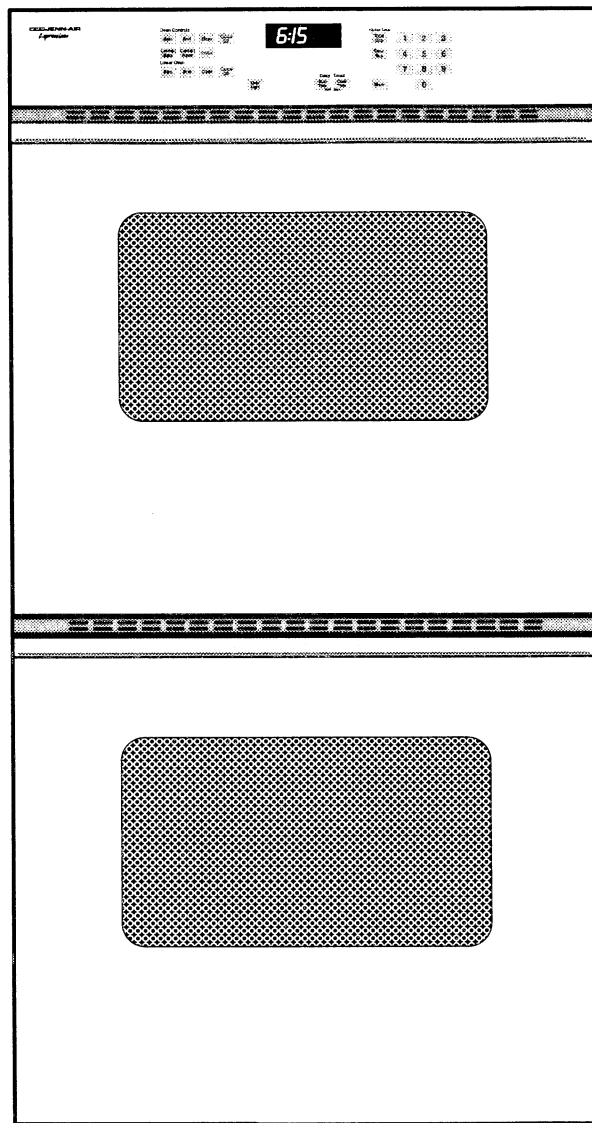

MODEL WW30430

For Microwave Oven, refer to Use and Care Manual packed in Microwave Oven.

About Your Jenn-Air Oven

Congratulations on your choice of a Jenn-Air wall oven. Your Jenn-Air convection oven combines the best of four cooking methods: conventional baking or roasting, convection baking, convection roasting, and broiling, in a self-cleaning oven.

The Jenn-Air convection oven is actually a conventional oven that circulates heated air within the oven. As both bake and broil heating elements cycle on and off with the thermostat, a fan keeps the heated air circulating around the food. The constantly recirculating heated air in the convection oven strips away the layer of cooler air that surrounds food. Consequently, many foods cook more quickly. Distributed heat makes multiple rack cooking possible. Convection roasted meats retain their natural flavor and juiciness with less shrinkage than conventional roasting.

Before you begin cooking with your new oven, please take a few minutes to read and become familiar with the instructions in this book. On the following pages you will find a wealth of information regarding all aspects of using your new oven. By following the instructions carefully, you will be able to fully enjoy and properly maintain your oven and achieve excellent results with the food you prepare.

Should you have any questions about using your Jenn-Air oven, write to us. Be sure to provide the model number.

Jenn-Air Customer Assistance
c/o Maytag Customer Service
P.O. Box 2370
Cleveland, TN 37320-2370

Important Information

Model Number _____

Serial Number _____
(numbers appear on the serial plate on the oven front frame)

Date Purchased _____

JENN-AIR DEALER FROM WHOM PURCHASED

Address _____

City _____

Phone _____

Index

Baking	15
Baking Chart	16
Causes of Cake Failure	15-17
Convect Baking	17
Convect Cooking on Multiple Racks	14
General Recommendations	35-36
Before You Call For Service	
Broiling	26
Broiling	27
Broiling Tips	27
Broiling Chart	
Caring for Your Oven	34
Adjust Oven Temperature	34
Child Protection Lock	32
Cleaning Other Surfaces..	33
Oven Light Bulb Replacement	
Cleaning	
Self-Cleaning Process	28-32
Clock Controls	12-13
Clock Controlled Baking or Roasting	10
Time of Day Clock	11
Timer	
Oven Operation	6
Oven Control Panel	9
Rack Positions	8
Setting Controls	
Probe	22-25
Roasting	
Conventional Roasting Recommendations	18
Convect Roasting	19-21
Frozen Convenience Foods	21
General Roasting Recommendations	18
Roasting Chart	19
Safety Precautions	4-5

SAFETY PRECAUTIONS

Read before operating your oven

All appliances - regardless of the manufacturer - have the potential through improper or careless use to create safety problems. Therefore the following safety precautions should be observed:

1. Be sure your appliance is properly installed and grounded by a qualified technician.
2. Never use your appliance for warming or heating the room.
3. Children should not be left alone or unattended in area where appliance is in use. They should never be allowed to sit or stand on any part of the appliance.
4. Wear proper apparel. Loose-fitting or hanging garments should never be worn while using the appliance.
5. Do not repair or replace any part of the appliance unless specifically recommended in this manual. All other servicing should be referred to an authorized Jenn-Air Service Contractor.
6. Flammable materials should not be stored in an oven.
7. Do not use water on grease fires. Smother fire or flame or use dry chemical or foam-type extinguisher.
8. Use only dry potholders. Moist or damp potholders on hot surfaces may result in burns from steam. Do not let potholder touch hot heating elements. Do not use a towel or other bulky cloth.
9. Use care when opening oven door. Let hot air or steam escape before removing or replacing food.
10. Do not heat unopened food containers. Build-up of pressure may cause container to burst and result in injury.
11. Keep oven vent ducts unobstructed.
12. Always place oven racks in desired location while oven is cool. If rack must be moved while oven is hot, do not let potholder contact hot heating element in oven.
13. Do not clean door gasket. The door gasket is essential for a good seal. Care should be taken not to rub, damage, or move the gasket.
14. Do not use oven cleaners. No commercial oven cleaner or oven liner protective coating of any kind should be used in or around any part of the oven.
15. Clean only parts listed in this manual.
16. **CAUTION: BEFORE SELF-CLEANING THE OVEN, REMOVE FOOD, BROILER PAN AND OTHER UTENSILS.**

17. Listen for fan. A fan noise should be heard during the bake, convection bake, convection roast, broil and cleaning cycles. If not, call a serviceman.
18. **DO NOT TOUCH HEATING ELEMENTS OR INTERIOR SURFACES OF OVEN.** Heating elements may be hot even though they are dark in color. Interior surfaces of any oven become hot enough to cause burns. During and after use, do not touch, or let clothing or other flammable materials contact heating elements or interior surfaces of oven until they have had sufficient time to cool. Other surfaces of the appliance may become hot enough to cause burns-among these surfaces are: oven vent openings and surfaces near these openings, oven doors, windows of oven doors.
19. **PREPARED FOOD WARNING:** Follow food manufacturer's instructions. If a plastic frozen food container and/or its film cover distorts, warps or is otherwise damaged during cooking, immediately discard the food and its container. The food could be contaminated.
20. This appliance has been tested for safe performance using conventional cookware. Do not use any devices or accessories that are not specifically recommended in this manual. Do not use add-on convection systems. The use of devices or accessories that are not expressly recommended in this manual could create serious safety hazards, result in performance problems, and reduce the life of the components of the appliance.
21. Do not allow aluminum foil or meat probes to contact heating element.

IMPORTANT SAFETY NOTICE AND WARNING

The California Safe Drinking Water and Toxic Enforcement Act of 1986 (Proposition 65) requires the Governor of California to publish a list of substances known to the State of California to cause cancer or reproductive harm, and requires businesses to warn customers of potential exposures to such substances. Users of this appliance are hereby warned that when the oven is engaged in the self-clean cycle, there may be some low level exposure to some of the listed substances, including Carbon Monoxide. Exposure to these substances can be minimized by properly venting the oven to the outdoors during the self-clean cycle.

- SAVE THESE INSTRUCTIONS -

Oven Operation

Oven Control Panel

The control panel is designed for ease in programming. The Display Window features Indicator Words which will flash to prompt you for the next step.

To program

1. Touch the function pad to give command desired.
2. Touch the appropriate number pads to enter time or temperature.

Note: Five seconds after entering the number, the time or temperature will automatically be entered. If more than five seconds elapse between touching a function pad and touching a number pad, the control is not set and Display will return to previous Display.

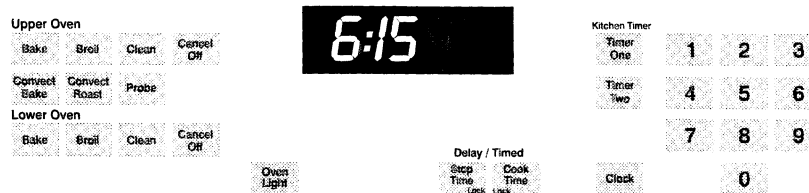

Function Pads

Bake	Use for conventional baking or roasting.
Broil	Use for top browning or oven broiling.
Clean	Use to set self-cleaning process.
Cancel Off	Cancels all programming except Timer.
Convection Bake	Use for convection baking.
Convection Roast	Use for convection roasting.
Probe	Use to set desired internal temperature when using Probe.
Oven Light	Use to turn oven light on and off.
Stop Time Lock	Use for clock controlled cooking and cleaning when delayed start is desired. (For lock function see page 34.)
Cook Time Lock	Use for clock controlled cooking. (For lock function see page 34.)
Timer One	Use to signal expiration of a time period up to 11 hours and 55 minutes.
Timer Two	Use to signal expiration of a time period up to 11 hours and 55 minutes.
Clock	Use to set time of day.

Number Pads

Use to set time or temperature.

Oven Light Pad (Control Panel)

The oven light automatically comes on whenever the oven door is opened. When door is closed, touch the **Oven Light Pad** to turn oven light on or off. **Note:** A beep will sound every time the **Oven Light Pad** is touched.

Display Window

Shows time of day, timer, and oven functions.

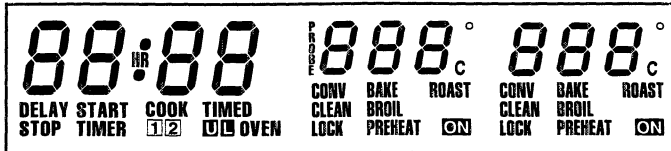

Display Numbers:

- Show time of day.
- Countdown of time remaining when using time functions.
- Show temperature of oven as it rises to reach programmed temperature and the set temperature once it is reached.
- Recall programmed temperature or time when commanded.
- Rounding of Display Numbers: Temperature range is 100° to 550°F and can be set in 5° increments. When setting temperature, the control will round it to the nearest 10°. For example, if 237° is entered, the control will round the temperature to 240°.

Prompts:

- Serve as a reminder to shut oven door, if it is open, for self-cleaning operation when the word, *door*, is displayed.
- "Err" will appear in the Display when an improper temperature or time has been entered. "Err" will flash and a beep will be heard three times. Then, the Display will return to the previous Display before the error was entered.

Indicator Words:

- Flash to prompt next step.
- Indicate status of programmed function.
- Show programmed function when recalled.
- Show oven selected. U - is the upper oven; L - is the lower oven. (Model WW30430)

Chimes vs. Beeps

- A chime sound is used to designate the end of a timing or cooking operation.
- A beep sound will be heard when any pad is touched. A series of short beeps are used to designate an incorrect entry, door is open when set for a self-clean, probe needs to be removed and a fault code.

End of Cycle Chimes:

- The end of cycle chimes is four short chimes followed by "reminder" chimes for a specified length of time, until you cancel that function. For the Timer function, there are two "reminder" chimes every 30 seconds for five minutes. For the Timed Cook, functions there is one "reminder" chime every minute for ten minutes. To cancel these "reminder" chimes, touch the appropriate pad again (either the **Timer Pad** or **Cook Time Pad**). You may also touch the **Cancel Off Pad** to cancel the "reminder" chimes, but it will also cancel all other oven functions.
- If you would like to eliminate all the "reminder" chimes entirely, touch and hold the **Cancel Off Pad** for twelve seconds. (This will not eliminate the initial four short chimes).
- To return the "reminder" chimes, touch and hold the **Cancel Off Pad** for twelve seconds.

NOTE: To change the oven to a 24 hour clock or Celsius (C) degrees, contact your authorized Jenn-Air Service Contractor or installer.

Setting Controls

BASIC INSTRUCTIONS

1. Position oven racks.
2. Touch **Bake Pad**, **Convect Bake Pad**, or **Convect Roast Pad**.
3. Touch the appropriate number pads for desired temperature.

To set oven on Bake or Convect Bake or Convect Roast

1. Place oven racks on proper rack positions. (See page 9.)
2. Touch **Bake Pad** or **Convect Bake Pad** or **Convect Roast Pad**.
Indicator Words BAKE or CONV BAKE or CONV ROAST will flash and three dashes will be shown.
Note: If more than five seconds elapse between touching a pad and touching a number pad, Display will return to previous Display.
3. Touch the appropriate number pads for desired oven temperature.
Allowable temperature range is 100° to 550°F. After five seconds the oven will begin to preheat. The Indicator Words ON, PREHEAT, and either BAKE or CONV BAKE or CONV ROAST will appear in the Display. The temperature shown will be 100° or the oven temperature whichever is higher.

Example: If at 10 o'clock you set the oven for 350° for convect baking, after five seconds the Display will show:



During the preheat, the Display will show a rise in 5° increments until programmed temperature is reached. When the oven is preheated, the oven will chime, the ON and PREHEAT Indicator Words will go off, and programmed oven temperature will remain in the Display.

Note: Oven will preheat for approximately 7 to 11 minutes.

Important: Whenever ON appears in the Display, the oven is heating.

To recall temperature set during preheat: Touch the appropriate **Bake Pad** or **Convect Bake Pad** or **Convect Roast Pad**. Temperature will be briefly displayed, then will automatically return to on-going program.

To change temperature set: Touch appropriate **Bake Pad** or **Convect Bake Pad** or **Convect Roast Pad** and the appropriate number pads for the new desired temperature.

Note: If you are lowering the temperature below the current oven temperature, the Indicator Words PREHEAT and ON will appear briefly in the Display and the preheat chime will sound. Then, the Display will show programmed temperature and indicator word BAKE or CONV BAKE or CONV ROAST only.

4. Touch **Cancel Off Pad** to turn oven off at end of baking. The oven will continue operating until the **Cancel Off Pad** is touched.

Rack Positions

The rack positions noted are generally recommended for the best browning results and most efficient cooking times. For many food items, excellent results can be achieved *when using one of several different rack positions*. Refer to baking and roasting sections for recommendations for specific foods.

Different Racks

Two flat racks and one offset rack were packaged with your oven. The use of the offset rack is denoted in the list below and the charts as an "o" after the rack number. **Note WW30430 Owners:** An additional offset rack and flat were packaged in your oven.

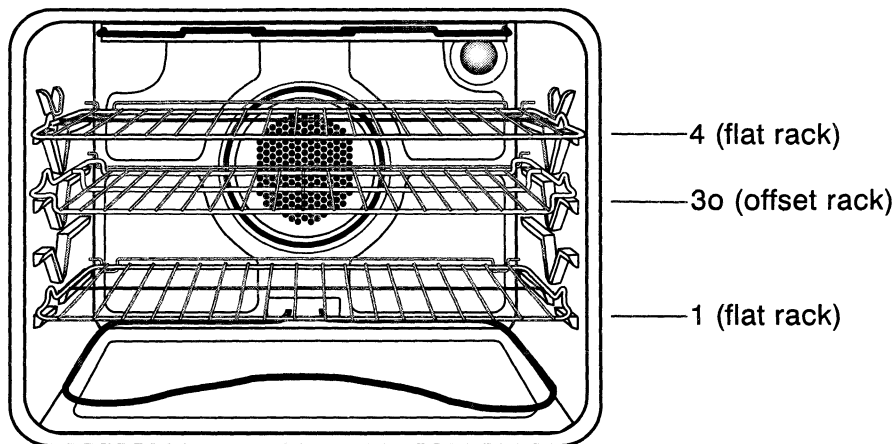

Rack Uses

Rack Position #4o (offset rack on #4):

Most broiling.

Rack Position #3:

Most baked goods on cookie sheets, cakes (sheet and layer).

Rack Position #3o (offset rack on #3):

Most baked goods on cookie sheets, frozen convenience foods, fresh fruit pie, cream pie, layer cakes, main dish souffle.

Rack Position #2:

Roasting small cuts of meat, cakes (tube, bundt or layer), frozen fruit pie, pie shell, large casseroles.

Rack Position #2o (offset rack on #2):

Roasting small cuts of meat, loaves of bread, angel food cake.

Rack Position #1:

Large cuts of meat and large poultry, angel food cake, loaves of bread, custard pie, dessert souffle.

Multiple Rack Cooking:

Two racks, use #2o and #4. Three racks, use #1,#3o, and #4.

Clock Controls

Time of Day Clock

When electrical power is supplied or after power interruption, the last clock time displayed before power was interrupted will flash. Time will advance and continue to flash until clock is reset.

BASIC INSTRUCTIONS

1. Touch **Clock Pad**.
2. Touch appropriate number pads.

To set Time of Day

1. Touch **Clock Pad**.

Indicator word TIME will flash and time digits will appear in the Display. (If more than five seconds elapse between touching **Clock Pad** and touching a number pad, the **Clock Pad** must be touched again in order to set clock.)

2. Touch the appropriate number pads until correct time of day appears in Display.

Note: Five seconds after touching the number pads, the time of day will automatically be entered.

IMPORTANT

- To recall time of day when another time function is showing: Touch **Clock Pad**.
- Clock time cannot be changed when oven has been programmed for Timed Bake, Timed Convection Bake, Timed Convection Roast or Self-clean. Cancel program before reprogramming clock.

Timer

Important: This interval Timer can be used to remind you when a period, up to 11 hours and 55 minutes, expires. It can be used independently of any other oven activity and can be set while another oven function is operating. The Timer does not control the oven.

BASIC INSTRUCTIONS

1. Touch **Timer Pad**.
2. Touch the appropriate number pads.

To set Timer

1. Touch **Timer Pad**.

The Indicator Word Timer and either 1 or 2 flashes and "0Hr:00" appears in the Display.

2. Touch the appropriate number pads until the desired number of minutes or hours and minutes appear in the Display.

Note: If more than five seconds elapse between touching a **Timer Pad** and a number pad, the **Timer Pad** must be touched again.

Example: To set Timer One for 5 minutes, touch the **Timer One Pad** and the number 5 pad. After five seconds, the display will show:



Example: To set Timer Two for 1 hour and 30 minutes, touch the **Timer Two Pad** and the numbers "1, 3, 0" pads. After five seconds, the Display will show:

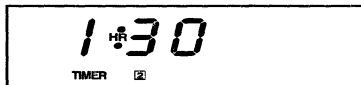

Countdown will start after five seconds. Countdown will have display precedence over other time functions. If both timers are set, the timer with the least amount of time remaining will have display precedence.

At the end of time set, the Timer will chime four times and "End" will appear in the Display. If timer is not cancelled (see below), "End" will remain in the Display and there will be two chimes every thirty seconds for five minutes.

To cancel Timer

1. Touch and hold the **Timer Pad** for four seconds.
OR
2. A. Touch the **Timer Pad**.
B. Touch "0" number pad. Five seconds later the Timer will be cancelled.

NOTE: Touching **Cancel Off Pad** to cancel chimes will cancel ALL selected oven programming.

Clock Controlled Baking or Roasting

BASIC INSTRUCTIONS

1. Touch **Bake Pad** or **Convect Bake Pad** or **Convect Roast Pad**.
2. Touch the appropriate number pads for desired temperature.
3. Touch **Cook Time Pad**.
4. Touch the appropriate number pads to enter cooking hours & minutes.
5. Touch **Stop Time Pad**.*
6. Touch the appropriate number pads to enter Stop Time.*

*Omit steps 5 & 6 if you want baking to start immediately.

To set oven to start immediately and shut off automatically

1. Touch **Bake Pad** or **Convect Bake Pad** or **Convect Roast Pad**.
Indicator Words BAKE or CONV BAKE or CONV ROAST will flash and three dashes will be shown.
2. Touch the appropriate number pads for desired oven temperature.
After five seconds the oven will begin to preheat. The Indicator Words ON, PREHEAT, and BAKE or CONV BAKE or CONV ROAST will appear in the Display. The temperature shown will be 100° or the temperature of the oven, whichever is higher. **Example:** If at 10 o'clock you set the oven for 350° for convection baking, the Display will show:

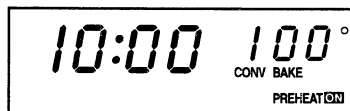

During the preheat, the Display will show a rise in 5° increments until programmed temperature is reached. When the oven is preheated, the oven will chime, the ON and PREHEAT Indicator Words will go off, and programmed oven temperature will be displayed. **Important:** Whenever ON appears in the Display, the oven is heating.

3. Touch **Cook Time Pad**.
Indicator Words COOK TIME will flash and Display will show "0 HR:00".
4. Touch the appropriate number pads to enter cooking hours in five minute increments. Hours are to left of colon and minutes to right of colon. (Allowable range is 5 minutes to 11 hours and 55 minutes.) **Example:** If cooking time selected for the oven is 2 hours and 30 minutes, the Display will show:

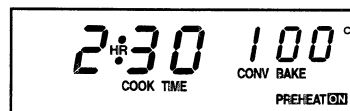

After five seconds, the time of day returns to the Display. **Important:** Oven will preheat for approximately 7 to 11 minutes. At end of programmed Cook Time, oven will shut off automatically; retained heat will continue to cook food. Clock controlled cooking is not recommended for baked items that require a preheated oven, such as cakes, cookies, pies, breads. For these foods, place food in preheated oven, then use Timer to signal end of baking time.

At the end of programmed Cook Time, the oven will shut off automatically and a "chime" will be heard four times and "End" will appear in the Display. If oven is not cancelled, "End" will remain in the Display and there will be one chime every minute for ten minutes.

To set oven to start at future time and shut off automatically

1-4. Follow preceding Steps 1-4, on page 12.

5. Touch **Stop Time Pad**.

Indicator Words STOP and TIME will flash. Display will show the calculated stop time based on current time of day and cook time. **Note WW30430 Owners:** The appropriate letter (U - upper oven; L - lower oven) and OVEN will also flash.

6. Touch the appropriate number pads to enter desired stop time.

A stop time can only be accepted for later in the day. **Note:** Since food continues to cook if left in the oven, it is suggested that the clock controls be used primarily to start the oven when no one is in the kitchen. Provisions should be made to have the food removed as soon as the chime has sounded.

Example: If at 10 o'clock you set the oven for 350° convection baking and 2 hours and 30 minutes cooking time, the calculated stop time would be "12:30". The Display would show:

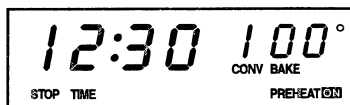

If you want the stop time to be 1 o'clock, touch the number pads "1,0,0". Five seconds later, the Display will briefly show the start time:



After five seconds, the display will return to current time of day, thus showing:



At the end of the delayed period, the DELAY Indicator Word will go off and the oven will begin to heat. 100° will be shown. As the oven heats, the Display will show a rise in increments of 5° until programmed temperature is reached.

At the end of programmed Cook Time, the oven will shut off automatically and a "chime" will be heard four times and "End" will appear in the Display. If oven is not cancelled, "End" will remain in the Display and there will be one chime every minute for ten minutes.

IMPORTANT

- **Note WW30430 Owners:** Clock controlled baking can be used with only one oven at a time. To program, first set the bake or convection bake or convection roast function for the desired oven, then set the cook time. If one oven is set for clock controlled baking, the other oven cannot be set to self-clean.
- **To recall time function programmed:** Touch the appropriate time pad.
- **To cancel timed function only:** Hold **Cook Time Pad** for four seconds. This will only cancel cook time and stop time, not programmed bake mode.
- If more than five seconds elapse between touching a function pad and touching appropriate number pads, the oven is not set and Display will return to previous Display.

Baking

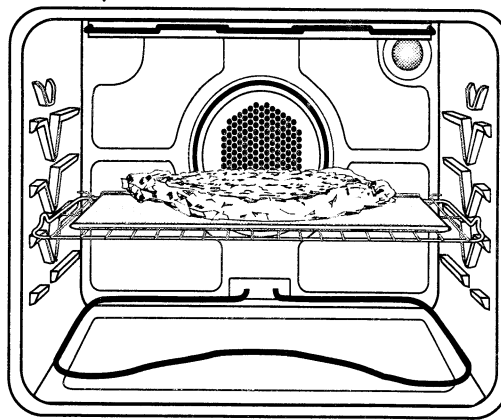
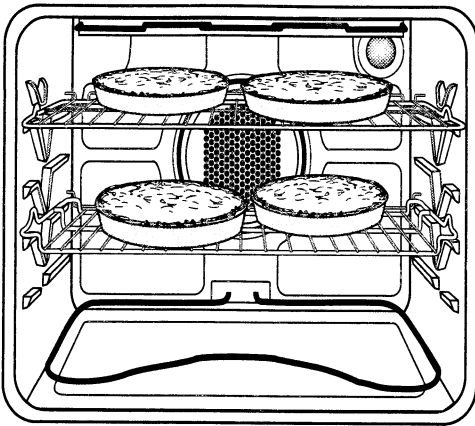

General Baking Recommendations

- When cooking foods for the first time in your new oven, use recipe cooking times and temperatures as a guide.
- Use tested recipes from reliable sources.
- Preheat the oven only when necessary. For baked foods that rise and for richer browning, a preheated oven is better. Casseroles can be started in a cold oven. Preheating takes from 7 to 11 minutes; place food in oven after PREHEAT Indicator Word cycles off.
- Arrange oven racks before turning on oven. Follow suggested rack positions on page 9 and in various baking charts.
- Allow about 1 to 1½ inches of space between the oven side walls and pans to allow proper air circulation.
- When baking foods in more than one pan, place them on opposite corners of the rack. *Stagger pans* when baking on two racks so that one pan does not shield another unless shielding is intended. (See above left)
- To conserve energy, avoid frequent or prolonged door openings. At the end of cooking, turn oven off before removing food.
- Always test for doneness (fingertip, toothpick, sides pulling away from pan). Do not rely on time or brownness as only indicators.
- Use good quality baking pans and the size recommended in the recipe.
- Dull, dark, enameled or glass pans will generally produce a brown, crisp crust. Shiny metal pans produce a light, golden crust.
- Frozen pies in shiny aluminum pans should be baked on a cookie sheet on rack 2 or be removed to a dull or glass pan.
- If edge of pie crust browns too quickly, fold a strip of foil around rim of crust, covering edge. (See above right.)

NOTE: A cooling fan will operate during all cooking modes. The fan may also continue to operate after the oven is turned off until the oven has cooled down.

Baking Chart

Note: For Conventional Bake use the **Bake Pad**.

Product and Type	Pan Size	Rack Position*	Convect Bake		Conventional Bake	
			Temp. (°F) Preheated***	Time**	Temp. (°F) Preheated	Time**
CAKE						
Yellow - 2 layers	9"	3o or 3	325°	22-30	350°	28-33
White - 2 layers	9"	3o or 3	325°	22-30	350°	25-30
Chocolate - 2 layers	9"	3o or 3	325°	25-30	350°	30-35
Angel Food	tube	2o or 2	350°	30-35	375°	30-40
Pound Cake	9x5 loaf	2	300°	50-60	325°	55-65
Cupcakes	2 pans	2o & 4	325°	15-20	350°	15-25
Sheet Cake	9x13"	3 or 3o	325°	26-31	350°	30-40
PIES						
Two Crust						
Fruit, fresh	9"	3o	350°-400°	45-60	375°-425°	45-60
Fruit, frozen	9"	2	350°-400°	40-65	375°-425°	40-65
One Crust						
Custard, fresh	9"	1	325°-375°	40-50	350°-400°	40-60
Meringue	9"	3o	325°-375°	7-11	350°-400°	8-12
Pie Shell	9"	2	425°	7-11	450°	8-12
COOKIES						
Chocolate Chip		3o or 3	325°-350°	6-10	350°-375°	7-11
Peanut Butter		3o or 3	325°-350°	6-10	350°-375°	7-11
Sugar		3o or 3	325°-375°	6-10	350°-400°	7-11
Brownies	9x13"	3o	325°	20-26	350°	25-31
BREADS, YEAST						
Loaf	9x5 loaf	1 or 2o	350°	17-23	375°	18-28
Rolls		3o	350°-375°	9-14	375°-400°	12-15
BREADS, QUICK						
Loaf, Nut, Fruit	8x4 loaf	2o	325°-350°	40-55	350°-375°	50-65
Gingerbread	9x9"	3o	325°	22-28	350°	25-35
Cornbread	8x8"	3o	375°-425°	13-28	400°-450°	15-30
Cornbread Muffins		3o	350°-375°	8-15	375°-400°	10-20
Biscuits		3 or 3o	375°-400°	7-11	400°-425°	8-15
Muffins		3o	350°-400°	15-20	375°-425°	15-25

- * An "o" after a rack number implies that the offset rack should be used.
- ** The times given are based on specific brands of mixes or recipes tested. Actual times will depend on the ones you bake.
- *** The Convect Bake temperature is 25°F lower than recommended on package mix or recipe.

Causes of Cake Failure

Problem	Possible Cause
Cake Falls	Oven not hot enough Insufficient baking Opening oven door during baking Too much or too little leavening, liquid or sugar
Peaks in center or cracks on top	Oven too hot at start of baking or overbaking Pan size too small Too little or too much flour or leavening Overmixing
Flat Cake	Pan too large Overmixing or undermixing Too much or too little liquid Old or too little baking powder
Uneven cakes	Oven not level Batter uneven Cake pans too close to oven walls or each other
Sticks to pan	Cake cooled in pan too long Pan not greased and floured
Cracks and falls apart	Removed from pan too soon Too much shortening, leavening or sugar
Excessive shrinkage from sides of pan	Oven too hot or overbaking Overmixing

Convect Baking Recommendations

- Use convection baking for breads, cakes, cookies, and pies.
- As a general rule, when using recipes or prepared mixes developed for a conventional bake oven, set the oven temperature 25°F lower than the recipe recommended temperature. Times will be similar to or a few minutes less than recipe recommended times. The chart on page 15 compares times and temperatures of many baked foods. Use this as a reference.
- For better browning, place cookie sheets and baking pans lengthwise, side to side on the rack.
- Cookie sheets should be without sides and made of shiny aluminum. The best size to use for cookie sheets is 16" x 12" or smaller.

Convect Cooking on Multiple Racks

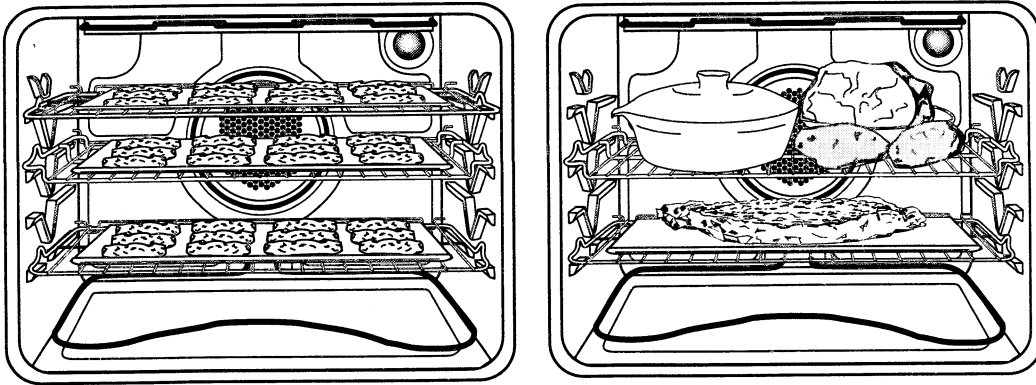

For best results, bake foods on one rack at a time as described in this manual. However, very good results can be obtained when baking quantities of foods on multiple racks. Quantity cooking provides both time and energy savings.

Convect Bake is suggested for most multiple rack cooking, especially three rack cooking, because the circulating heated air results in more even browning. For two rack cooking, the conventional bake oven provides very good baking results especially when pans can be staggered, such as with layer cakes and fresh pies.

Many foods can be prepared on three racks at the same time. These are just a few examples: cookies, cupcakes, rolls, biscuits, muffins, pies, pizzas, appetizers, and snack foods.

To obtain the best results in multiple rack cooking, follow these suggestions:

- Use temperature and times in this manual as a guide for best results.
- For two rack baking, rack positions #20 and 4 are best for most baked products but positions #2 and 4 also provide acceptable results.
- For three rack baking use positions #1, 30 and 4. One exception is pizza. (See page 21.)
- Since foods on positions #1 and 4 will usually be done before foods on position #30, additional cooking time will be needed for browning foods on the middle rack. An additional minute is needed for thin foods such as cookies. For foods such as biscuits, rolls, or muffins, allow 1 to 2 more minutes. Frozen pies and pizzas, which should be baked on a cookie sheet, need about 2 to 4 more minutes.
- Stagger small pans, such as layer cake pans, in the oven.
- Frozen pies in shiny aluminum pans should be placed on cookie sheets and baked on rack positions #1, 30 and 4.
- Cookie sheets should be placed *lengthwise, side to side*, in front of the fan for more even browning.
- Oven meals are recommended for energy conservation. Use rack positions #1 and 30 or #20 and 4 and **Convect Roast**.

Roasting

General Roasting Recommendations

- *Preheating is not necessary.*
- For open pan roasting, place meat or poultry on the slotted portion of the two-piece pan included with the oven. Do not add water to the pan. Use open pan roasting for tender cuts of meat. Less tender cuts of meat need to be cooked by moist heat in a covered pan.
- For best results, a meat thermometer or probe is the most accurate guide to degree of doneness. The tip of the thermometer or probe should be located in the thickest part of a roast, not touching fat, bone, or gristle. For turkeys and large poultry products, insert the tip of the thermometer or probe into the thickest part of the inner thigh.
- Place roast fat side up to allow self basting of meat during roasting.
- Since meats continue to cook after being removed from the oven, remove roast from oven when it reaches an internal temperature about 5 degrees below the temperature desired.
- For less loss of juices and easier carving, allow about 15 minutes "standing time" after removing meat from oven.
- For best results in roasting poultry, thaw completely. Due to the structure of poultry, partially thawed poultry will cook unevenly.

Conventional Roasting Recommendations Using Bake Pad

- If preferred, tender cuts of meat can be roasted in the conventional bake oven by following the general recommendations given above. However, meats will roast more quickly in the convect oven using **Convect Roast**.
- Conventional bake is best for less tender cuts of meat that require a longer, moist heat method of cooking. Follow your recipe for times and temperatures for covered meats.
- Meats cooked in oven cooking bags, dutch ovens, or covered roasting pans are best cooked in the conventional bake oven using the **Bake Pad**.
- Use meat roasting charts in standard cookbooks for recommended times and temperatures for roasting in a conventional bake oven.

NOTE: A cooling fan will operate during all cooking modes. The fan may also continue to operate after the oven is turned off until the oven has cooled down.

Roasting Chart

Chart time is based on thawed meats only. For Conventional Roasting use the **Bake Pad**.

Variety and Cut of Meat	Approx. Weight (lb)	Oven Temp (°F) no preheat*	Internal Temp of Meat - End of Roasting Time (°F)	Approx Convect Roasting Time (minutes per lb)	Approx Conventional Roasting Time (minutes per lb)
BEEF					
Rib Roast	4 to 8	325°	145° (rare) 160° (medium)	25-30 30-35	30-35 35-40
Rib Eye Roast	4 to 6	325°	145° (rare) 160° (medium)	25-30 30-35	30-35 35-40
Tenderloin Roast	2 to 3	400°	145° (rare)	18-23	23-28
Eye of Round Roast	4 to 5	325°	145° (rare) 160° (medium)	25-30 30-35	30-35 35-40
Top Loin Roast	3 to 6	325°	145° (rare) 160° (medium)	25-30 30-35	30-35 35-40
Round Tip Roast	4 to 6	325°	145° (rare) 160° (medium)	25-30 30-35	30-35 35-40
PORK					
Shoulder Blade Roast Boneless	4 to 6	325°	170°	30-40	35-45
Shoulder Blade Roast	4 to 6	325°	170°	25-35	30-40
Top Loin, boneless	3 to 4	325°	170°	30-40	35-45
Ham, Half (Fully cooked)	5 to 7	325°	140°	NA**	25-35
Ham, Half (Cook before eating)	5 to 7	275°	160°	30-40	35-45
Arm Picnic Shoulder (Fully cooked)	5 to 8	325°	140°	20-25	25-30
POULTRY					
Turkey, unstuffed	8 to 12	325°	180°-185°	15-17	20-22
Turkey, unstuffed	12 to 16	325°	180°-185°	13-15	18-20
Turkey, unstuffed	16 to 20	325°	180°-185°	11-13	16-18
Turkey, unstuffed	20 to 24	325°	180°-185°	9-11	14-16
Turkey, Breast	3 to 8	325°	170°-175°	25-35	30-40
Chicken, Whole	2½ to 3½	375°	185°	19-23	22-26
Cornish Game Hen	1 to 1½	375°	180°-185°	35-45	45-55
Duck	4 to 6	350°	185°	15-20	20-25

* When using the Convect Roast mode, there is no need to preheat the oven or to lower the temperature from conventional roast temperatures.

** Not recommended for convection cooking. Most precooked hams have to be covered while roasting, thus there would be no time savings from using the convect mode.

Convect Roasting Recommendations

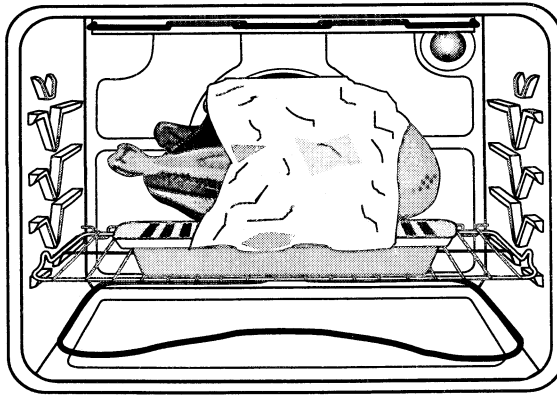

- Tender cuts of meat and poultry can be roasted to a rich golden brown in the convection oven. Follow general recommendations for roasting and use **Convect Roast**.
- Refer to convection meat roasting chart for recommended cooking temperature and time. The chart can serve as a guide to help plan meal serving time.
- Minutes per pound will vary according to the size, shape, quality, and initial temperature of meat as well as the electrical voltage in your area. Times are based on refrigerator cold meat.
- A large cut of meat will usually require fewer minutes per pound to roast than a smaller cut of meat.
- Do not use a roasting pan with high sides; use pan provided with oven.
- Do not cover meat. Allow the circulating hot air to surround the meat and seal in the juices.
- Since the breast meat on a large turkey cooks more quickly than the thigh area, place a "foil cap" over the breast area after desired brownness is reached to prevent overbrowning. (See above.)
- A stuffed turkey will require an extra 30 to 60 minutes depending on size. Stuffing should reach an internal temperature of 165°F.

Convect Roasting: Frozen to Finish

Meats (except poultry) may be roasted frozen to finish. Follow these guidelines for the most satisfactory results.

- Use temperatures for roasting fresh meats as recommended by most cookbooks. Generally, most meats are roasted at 325°F. For best results do not use temperatures below 300°F.
- Use times for roasting *fresh* meats given in your favorite cookbooks as approximate guides for roasting *frozen* meats. Roasting times will vary due to factors such as coldness of meat, size, quality, or cut. In general, roasting times for frozen to finish in the convection oven will be approximately the same as fresh to finish in a conventional bake oven.
- The guidelines given for roasting fresh meats in the convection oven also apply to roasting frozen meats.
- Insert meat thermometer or probe midway during the cooking process.

Convect Roasting of Frozen Convenience Foods

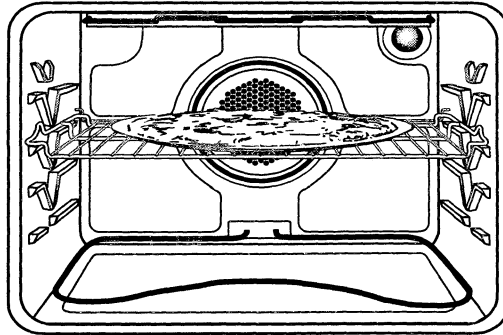

- Use the **Convect Roast Pad** for best results.
- *Preheating the oven is not necessary.*
- Follow package recommendations for oven temperature, foil covering and use of cookie sheets. Cooking times will be similar. See chart below for some exceptions and examples.
- Center foods in the oven. If more than one food item is being cooked or if foods are being cooked on multiple racks, stagger foods for proper air circulation.
- Most foods are cooked on rack position #3o.
- For multiple rack cooking, use racks #1, 3o and 4. However, pizzas should be placed on cookie sheets and cooked on rack position #2o, 3 and 4.

Here are a few examples of times and temperatures

Frozen Convenience Foods	Rack Position*	CONVECT ROAST OVEN NOT PREHEATED		CONVENTIONAL BAKE** PREHEATED	
		Temp.° F	Minutes	Temp.° F	Minutes***
Chicken, fried	3o	375°	40-45	375°	40-45
Fish, sticks	3	400°	13-18	400°	15-20
French fries	3	450°	20-25	450°	20-25
Pot Pies	3o	400°	30-35	400°	30-35
Pizza	3o	400°	12-15	400°	12-15

* An "o" after a rack number implies that the offset rack should be used.

** Conventional bake uses the **Bake Pad**.

*** The times given are based on specific brands of mixes or recipes tested. Actual times will depend on the ones you cook.

Note: Convect roasting times will be similar to the conventional times because the oven is not preheated. The time savings comes from not having to preheat the oven.

Probe

How to Install and Set the Probe

BASIC INSTRUCTIONS

1. Insert probe.
2. Touch **Probe Pad**.
3. Touch the appropriate number pads to set a desired endpoint temperature.
4. Touch **Bake Pad** or **Convect Bake Pad** or **Convect Roast Pad**.
5. Touch the appropriate number pads to enter desired temperature.
6. Touch **Cook Time Pad**.*
7. Touch the appropriate number pads to enter estimated cooking time.*
8. Touch **Stop Time Pad**.*
9. Touch the appropriate number pads to enter Stop Time.*

*Omit steps 6-9 if you wish to start cooking immediately.

To set probe feature

1. Insert the probe into the food item.

For meats, the probe tip should be located in the center of the thickest part of the meat and not in fat or touching a bone.

Place the food in the oven using the rack position suggested on page 9.

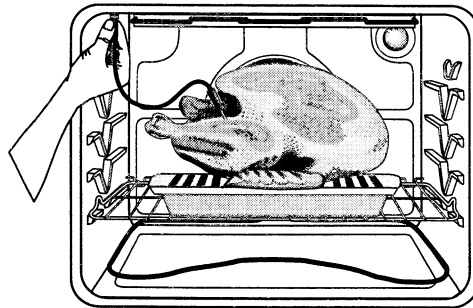

Insert the probe plug into the receptacle located on the top left of the oven. Be certain to insert plug into the receptacle all the way.

Note: After the probe is inserted, the Indicator Word PROBE will flash and a beep will sound reminding you to enter the desired probe temperature.

2. Touch **Probe Pad**.

Indicator Word PROBE will flash and three dashes will be shown in the Display.

3. Touch the appropriate number pads to set the temperature for desired degree of doneness.

The temperature may be set in 5° increments. (Allowable range is 100° to 200°.)

Example: At 10 o'clock to set the probe for 150°, touch the **Probe Pad** and the number pads "1,5,0". After five seconds the Display will show probe temperature or 95°, whichever is higher. Indicator Words CONV, BAKE and ROAST will flash.

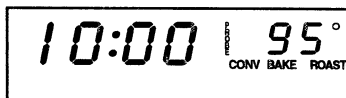

4. Touch **Bake Pad** or **Convect Bake Pad** or **Convect Roast Pad**.

Indicator Words BAKE or CONV BAKE or CONV ROAST will flash and Display will show three dashes.

5. Touch the appropriate number pads for desired oven temperature.

Example: If at 10 o'clock you set the oven for a probe temperature and to convection roast at 325°, after five seconds the Display will show:



When selected temperature has been reached, the oven will shut off and a chime will sound four times. Plus, the actual probe temperature will flash and the word "End" will be in the Display. These words will remain in the Display and a chime will sound every minute for ten minutes or until the **Cancel Off Pad** is touched. If the probe is not removed, a beep will sound continuously until the probe is removed.

Note: Once selected internal temperature has been reached, unplug the probe from the oven and remove food immediately to prevent overcooking. Hold plug with potholder when removing from the oven.

Important: The probe must be unplugged and removed from oven when it is not being used. If probe is left plugged in oven and Probe feature is not programmed, a beep will sound continuously and PROBE will flash continuously.

To use Probe feature to start at future time and shut off automatically

IMPORTANT: Both estimated cook time and stop time must be set or oven will start immediately. Therefore, follow all nine steps.

1-5. Follow preceding steps 1-5 on pages 22-23.

6. Touch **Cook Time Pad**.

Indicator Words COOK TIME will flash and Display will show "0 HR :00".

Note WW30430 Owners: The appropriate letter (U-upper oven; L-lower oven) and OVEN will also flash.

7. Touch the appropriate number pads to enter cooking hours in 5 minute increments.

Hours are to left of colon and minutes to right of colon.

(Allowable range is 5 minutes to 11 hours and 55 minutes.)

Example: If cooking time selected for the oven is 2 hours and 30 minutes, the Display will show:



Fifteen seconds later, the Display will return to current time of day and the Indicator Word **TIMED** will appear in the Display.



8. Touch **Stop Time Pad**.

Indicator Words **STOP TIME** will flash. Display will show the calculated stop time based on current time of day and cook time.

Note: Probe set temperature will control the actual bake time. Probe temperature, not stop time, will turn oven off when food is done. Stop time is programmed for the purpose of computing start time.

9. Touch the appropriate number pads to enter stop time.

A stop time can only be accepted for later in the day. If an unacceptable stop time is entered, "Err" will flash briefly in the Display and then Display will return to previous acceptable Stop Time.

Example: If at 10 o'clock you set the oven for a probe temperature, for 325° convection roasting and 2 hours and 30 minutes cooking time, the calculated stop time would be "12:30". The Display would show:

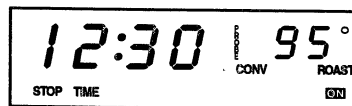

If you want the stop time to be 1 o'clock, touch the number pads "1,0,0". After five seconds, the Display will briefly display the start time. Thus, the Display would show:



After five seconds, the Display will return to current time of day, thus showing:



When selected temperature has been reached, the oven will shut off and a chime will sound four times. Plus, the actual probe temperature will flash and the word "End" will be in the Display. These words will remain in the Display and a chime will sound every minute for ten minutes or until the **Cancel Off Pad** is touched. If the probe is not removed, a beep will sound continuously until the probe is removed.

IMPORTANT

- To recall a selected temperature or time: Touch the appropriate function pad.
- To change oven temperature set: Touch appropriate pad and touch the appropriate number pads to enter new desired temperature.
- If more than five seconds elapse between touching a function pad and touching a number pad, the on-going program returns to the Display.

Hints on Successful Use of the Probe Feature

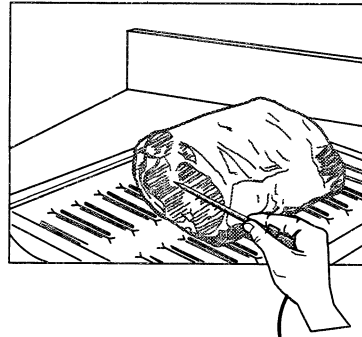
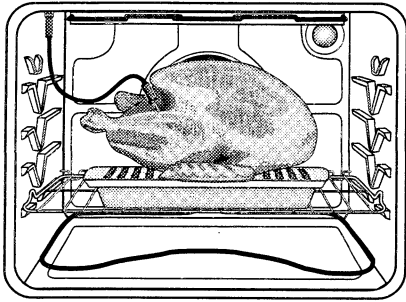

- The probe should be located in the center of the thickest part of a roast. Plan the placement of the probe tip by laying it lengthwise on the outside of the meat, marking with finger where edge of meat comes on the probe. Insert probe into thickest part of muscle up to the marking held by finger.
- Tip of probe should not touch fat, bone or gristle.
- For turkeys and large poultry products, insert probe into the thickest part of the inner thigh. Because of variables in cooking poultry, such as size and shape, use the thermometer as a guide to the degree of doneness but also use conventional methods, squeezing or wiggling drumstick, to test for doneness.
- Because of the excellent insulation of the oven, the retained heat continues to cook the meat after the signal has sounded and the oven has cycled off. For this reason, it is important to remove the meat from the oven as soon as the signal sounds.
- Meats continue to cook after being removed from the oven. As a suggestion, set the internal temperature 5 degrees below the desired final degree of doneness. Allow the "standing time" before carving (15 to 20 minutes) to finish cooking the food.
- Use the roasting chart on page 19 as a guide to the length of cooking time to help plan meal serving time for meats roasted in the convection oven.
- Use the handle of the probe for inserting or removing. Do not pull on the cable. Use a potholder to remove since probe becomes hot.
- For frozen roast, insert probe after 1½ to 2 hours.
- Probe feature can be used to register internal temperature of other foods, such as meatloaf.
- To clean cooled probe, wipe with a soapy dishcloth. Do not submerge probe in water.

Broiling

BASIC INSTRUCTIONS

1. Position oven rack.
2. Touch **Broil Pad**.
3. Touch the appropriate number pad(s) to set temperature.

To Broil

1. Place oven rack on the rack position suggested in the chart on page 27. Distance from broiling element depends on foods being prepared. Rack position 4o (offset rack in position #4) is usually recommended unless otherwise stated.
2. Touch **Broil Pad**.
Indicator Word BROIL will flash and Display will show three dashes.

Note: If more than five seconds elapses between touching **Broil Pad** and touching a number pad, the oven is not set and Display will return to previous Display.

3. Touch the appropriate number pad(s).
The first number pad touched will enter "HI" in the Display.

The oven has a variable broil feature which means that a lower temperature can be selected. After "HI" appears in the Display, touch the appropriate number pads for the desired temperature. Temperature can be entered in 5° increments. Use "HI" broil for most broil operations. Use variable broil for delicate and long-term items.

Five seconds after entering "HI" or a temperature, the broil element will come on and the Indicator Words BROIL and ON will remain in the Display. If the variable broil feature was selected, the Indicator Word ON will cycle with the element.

Example: If at 4 o'clock you set the oven for broil ("HI"), the Display will show:

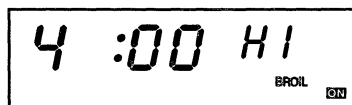

4. Place food on broiler pan provided with oven. Broil element will preheat in five minutes. After broil element is red, place food in oven. Oven door MUST be left open at broil stop position.
5. Touch **Cancel Off Pad** to turn off oven when food is cooked.

NOTE: A fan comes on during the BROIL cycle. If it does not, the oven broil element will cycle on and off. If the fan does not operate, contact your authorized Jenn-Air Service Contractor for repair.

Broiling Tips

- Tender cuts of meat or marinated meats are best for broiling. This includes rib and loin cuts of steak, ground beef, ham steaks, poultry pieces or fish. For best results, steaks should be at least 1" thick. Thinner steaks should be pan-broiled.
- Do not cover broiler grid with foil since this prevents fat drippings from draining into bottom of pan.
- Before broiling, remove excess fat from meat and score edges of fat (do not cut into meat) to prevent meat from curling. Salt after cooking.
- To prevent dry surface on fish or lean meats, brush melted butter on top.
- Foods that require turning should be turned only once during broiling. Turn meat with tongs to avoid piercing and loss of juices.

Broiling Chart

Chart time is based on a preheated broil element using the "HI" setting.

Foods	Rack Position*	Approximate (Minutes/Side)	
		1st Side	2nd Side
BEEF			
Steak (1")	4o		
Medium		9	7
Well		11	8
Hamburgers (3/4")	4o		
Medium		5	3-4
Well		6	4-5
PORK			
Bacon	4o	2	1-2
Chops (1/2")	4o	7	5-6
Chops (1")	3	10-11	9-10
Ham Slice	4o	4	2-3
POULTRY			
Breast Halves (Bone-in)	3	11-12	9-11
SEAFOOD			
Fish Steaks, Buttered (1")	4o	8-10	(no turning)
MISCELLANEOUS			
Hot Dogs	4o	2	2
Toast	4o	1	1

*An "o" after the rack number implies that the offset rack should be used.

Note: This chart is a suggested guide. The times may vary with food being cooked.

Oven Cleaning

How the Self Cleaning Process Works

When the oven controls are set to CLEAN, the oven heats to temperatures that are higher than those used for cooking. The high temperatures cause food soil to burn off and substantially disappear. While this occurs, a device in the oven vent helps to consume normal amounts of smoke. The oven is vented through an opening under the control panel.

Note WW30430 Owners: Both ovens cannot be self-cleaned at the same time.

How to Prepare Oven Before Operating the Self-Cleaning Process

- Remove the broiler pan and any other utensils from the oven. These utensils cannot withstand the high temperatures of the cleaning process.
- Clean spatters and spills from those areas which will not be cleaned during the self-cleaning process:
 - center front of oven and door near opening in door gasket.
 - porcelain oven door liner (area outside the door gasket).
 - oven front frame.

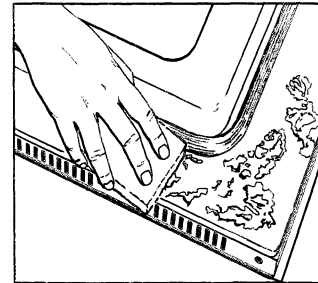

Note: DO NOT CLEAN serial plate located on the oven front. To clean these areas, use hot water and detergent, nonabrasive cleansers or soap filled steel wool pads. Rinse thoroughly, being careful not to use an excessive amount of water that would dampen the door gasket. *Soil left in these areas will be more difficult to remove after the self-cleaning process since the high heat will bake on any soil that is present.* DO NOT USE COMMERCIAL OVEN CLEANERS TO CLEAN THESE AREAS.

- DO NOT ATTEMPT TO CLEAN, RUB, OR APPLY WATER TO GASKET ON OVEN DOOR. The gasket is essential for a good door seal. Rubbing or cleaning will damage the gasket and may affect the seal.
- Wipe up excess grease and food spillovers which have not baked on the bottom of the oven. Large accumulations of soil can cause heavy smoke or fire in the oven during the cleaning process. For ease of cleaning, the heating element can be lifted slightly.
- Although smoke or fire in the oven is a normal occurrence and there is no safety problem, there will be venting of excessive smoke and odor.
- The oven racks can be cleaned in the oven. However, the oven racks will discolor, lose shininess, and become difficult to slide in and out if left in the oven during the cleaning process. REMOVE RACKS FROM OVEN IF THIS DISCOLORATION WILL BE OBJECTIONABLE. As a suggestion, do not leave the racks in the oven during the self-cleaning process if they do not need to be cleaned since they will discolor to a dull silver after one cleaning. Moderately soiled racks can be cleaned with a soapy S.O.S. pad or Scotch-Brite scour pad. Stubborn stains need to be removed in the self-cleaning process. Be sure to read special tips on page 32 if oven racks are cleaned during the self-cleaning process.

Steps to Follow for Self-Cleaning Process

BASIC INSTRUCTIONS

1. Close door.
2. Touch **Clean Pad**.
3. Touch the appropriate number pad(s) to enter desired cleaning time.
(Light soil-2 hours; Average soil-3hours; Heavy soil-4 hours)
4. Touch **Stop Time Pad**.*
5. Touch the appropriate number pads to enter desired stop time.*

*Omit steps 4 & 5 if you wish cleaning to begin immediately.

To set oven to start cleaning immediately

1. Close the oven door.
2. Touch **Clean Pad** of oven to be cleaned.
Indicator Words Clean Time will flash and Display will show “__ HR : __ __”.
Note WW30430 Owners: The appropriate letter (U-upper oven; L-lower oven) and OVEN will also flash.

3. Touch the appropriate number pad(s).
The first number pad touched will enter “3:00” in the Display for an average soiled oven. The cleaning time can be varied depending on the amount of soil. Set “2:00” for light soil or “4:00” for heavy soil.
Note: If more than five seconds elapse between touching a **Clean Pad** and touching a number pad, the oven is not set and time of day will automatically return to the Display.
Example: If at 9 o'clock you selected to self-clean your oven for 3 hours, the Display will show:



Five seconds after entering “3:00” or a different time, the oven door will start to automatically latch and the cooling fan will come on. The LOCK Indicator Word will come on when the door is latched.

Note: If oven door was left open, “door” will flash in Display and a signal will continuously beep until the door is closed and the **Clean Pad** is touched.

The Indicator Word ON comes on when the door is latched and will remain until the clean temperature is reached. The Indicator Word ON will cycle with the elements to maintain the clean temperature.

When the clean function has been completed, the Indicator Words CLEAN and ON will go off. The Indicator Word LOCK and the cooling fan will remain on until the oven has cooled down and the door has unlocked.

To set oven to start cleaning at a later time

1-3. Follow Steps 1-3 in previous section on page 29.

4. Touch **Stop Time Pad**.

Indicator Words STOP TIME will flash in the Display. The Indicator Word CLEAN and the calculated stop time will also appear in Display.

Note WW30430 Owners: The appropriate letter (U-upper oven; L-lower oven) and OVEN will also flash.

5. Touch the appropriate number pads to enter stop time.

A stop time can only be accepted for later in the day. If an unacceptable stop time is entered, "Err" will flash briefly in the Display and then Display will return to previous acceptable Stop Time.

Example: If at 9 o'clock you set the oven to clean for three hours, the calculated stop time would be "12:00". The Display would show:

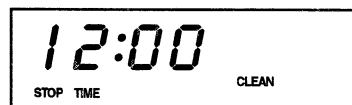

If you want the stop time to be 1 o'clock, touch the number pads "1,0,0". Five seconds later, the Display would show Start Time:



After five seconds, the Display will return to current time of day, thus showing:



The LOCK Indicator Word will come on and the cooling fan will go off as soon as the oven door has latched.

When the oven begins to clean, the Indicator Word ON and the cooling fan will come on and the Indicator Word DELAY will go off.

When the clean time has been completed, the Indicator Words CLEAN and ON will go off. The Indicator Word LOCK and the cooling fan will remain on until the oven has cooled down and the door has unlocked.

To cancel self-clean

- Touch **Cancel Off Pad**.
- The oven door will be locked while the LOCK Indicator Word remains in the Display. Depending on the length of time the oven had been self-cleaning, it may take up to 45 minutes for the oven to cool down, the door to unlock and cooling fan to turn off.

IMPORTANT

- **Note WW30430 Owners:** Both ovens CANNOT be cleaned at the same time. The LOCK Indicator Word for the first oven must go off before setting the second oven for a clean
- **Note WW30430 Owners:** If one oven is set to clean, the other oven cannot be set for clock controlled baking.
- **To recall cleaning time or stop time:** Touch the appropriate pad (**Clean Pad** or **Stop Time Pad**).
- **To change cleaning time or stop time before cleaning begins:** Repeat the preceding steps.
- When the **Clean Pad** is touched, a fan comes on. If this fan is not operating, the oven will go through the cleaning process at a reduced oven temperature and the oven will not clean effectively. If the fan does not operate, contact your authorized Jenn-Air Service Contractor for service.

More Information on the Self-Cleaning Process

- A slight odor may be detected, and if an oven is heavily soiled, some smoke may be visible. Some smoke and odor during the cleaning process is a normal occurrence. Since the oven is vented under the control panel, vapors, moisture, etc. may be seen coming from this area.
- During the cleaning process, do not be alarmed if an occasional flame is visible through the oven window. This is caused by excessive food soil that was not removed before the oven was set to clean.
- **SINCE THE DOOR AND WINDOW OF THE OVEN WILL GET WARM DURING THE SELF-CLEANING PROCESS, AVOID CONTACT.**
- Some types of soil may disintegrate but leave a light film or heavier deposit of ash. The amount of ash depends on the amount of soil which was in the oven. After oven has cooled, this ash may be removed with a damp sponge. If other dark deposits remain after wiping with a sponge, the time set for the length of cleaning was not enough. Increase the cleaning time for future cleanings or clean more frequently. The normal cleaning time is 3 hours. A maximum of 4 hours may be selected if necessary.

- If racks have been left in oven during the cleaning process, they should be treated as follows. After the cleaning process is completed and the oven has cooled, buff the underside of rack edges with Scotch-Brite scour pad or rub *lightly* the underside of rack edges with a coating of vegetable oil. Use a light application of oil so it does not soil the oven. This will make the cleaned racks slide more easily.

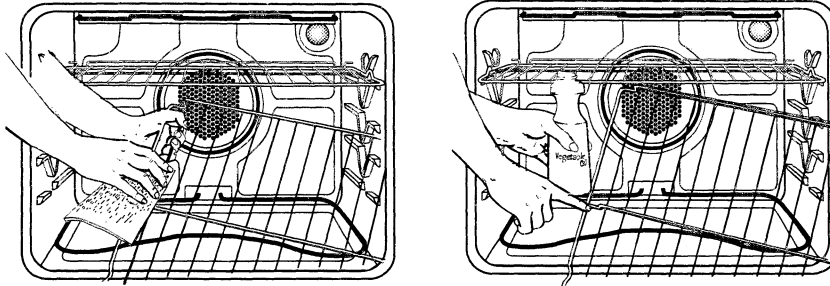

- To remove occasional spillovers between cleanings, use a soap-filled scouring pad or mild cleanser; rinse well.
- It is better to clean the oven regularly rather than wait until there is a heavy build-up of soil in the oven.
- During the cleaning process, the kitchen should be well ventilated to help eliminate normal odors associated with cleaning.
- DO NOT USE COMMERCIAL OVEN CLEANERS.
- DO NOT USE ALUMINUM FOIL OR OTHER LINERS IN THE OVEN.

Caring For Your Oven

Cleaning Other Surfaces of Your Oven

Oven Door Trim

Slightly dampen a cloth or paper towel with soapy water or nonabrasive cleanser such as Fantastik or 409. Do not use excessive amounts of water or allow water to run down through the air vents under the door handle since this will cause streaks which will be visible through the glass door. White parts may be cleaned with chlorine bleach or a nonabrasive cleanser that contains chlorine bleach. Do not use any abrasive cleansers, oven cleaners, or scrub with any abrasive materials, such as S.O.S. pads, Scotch-Brite pads, etc.

Glass Window or Glass Oven Door Front

Use any suitable glass cleaner or soapy water.

Control Panel Area and Display Window

Wipe with soft cloth dampened with soapy water or glass cleaner. Do not spray any cleaning solutions directly onto the display window or use large amounts of soap and water. *Do not scrub with S.O.S. pads or abrasive cleaners.*

Stainless Steel (select models)

Do not use any cleaning product containing chlorine bleach.
Always wipe with the grain when cleaning.

Daily Cleaning/Light Soil – Wipe with one of the following - soapy water, white vinegar/water solution, Formula 409 Glass and Surface Cleaner or a similar multi-surface cleaner - using a sponge or soft cloth. Rinse and dry. To polish and help prevent fingerprints, follow with Stainless Steel Magic Spray (Jenn-Air Model A912, Part No. 20000008).

Moderate/Heavy Soil – Wipe with one of the following - Bon Ami or Soft Scrub - using a damp sponge or soft cloth. Rinse and dry. Stubborn soils may be removed with a damp Scotch-Brite pad; **rub evenly with the grain.** Rinse and dry. To restore luster and remove streaks, follow with Stainless Steel Magic Spray (Jenn-Air Model A912, Part No. 20000008).

Discoloration – Using a damp sponge or soft cloth, wipe with Cameo Stainless Steel Cleaner. **Rinse immediately and dry.** To remove streaks and restore luster, follow with Stainless Steel Magic Spray (Jenn-Air Model A912, Part No. 20000008).

Oven Racks

To remove pull forward to the “stop” position; lift up on the front of the rack and pull out.

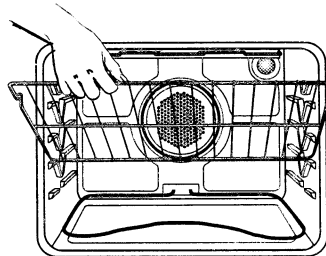

Oven Light Bulb

Before replacing bulb, *disconnect power to oven at the main fuse or circuit breaker panel.* Be sure that the entire oven cavity including the light bulb is cool before attempting to remove.

To replace light bulb

1. Carefully unscrew the glass light lens.
2. To obtain firm grasp on the bulb, wear protective rubber gloves. Remove by turning bulb to the left. **Do not touch a hot oven light bulb with a damp cloth as bulb will break. Note:** If the bulb does break and you wish to remove it, be certain power supply is disconnected and wear protective gloves. You may contact your authorized Jenn-Air Service Contractor for service.
3. Replace bulb with a *40 watt oven-rated appliance bulb.* Bulb with brass base is recommended to prevent fusing of bulb into socket.
4. Replace bulb cover and reconnect power to oven. Reset clock.

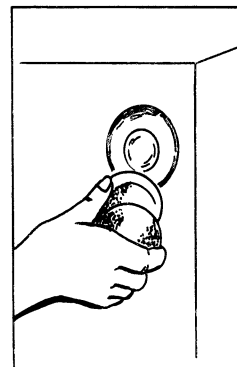

Adjust Oven Temperature

The oven temperature can be adjusted if all oven temperatures are too low or too high and the length of time to cook ALL foods is too long or too short. Do NOT adjust the temperature if only one or two items are not baking properly.

To adjust

1. Touch the **Bake Pad**.
2. Enter 500° by touching the number pads: "5,0,0".
3. Touch and hold the **Bake Pad** for 8 seconds until "00°" appears in the Display.
4. Touch the appropriate number pads to enter the offset temperature. (Allowable range is -35° to +35°.) **Note:** Touching the **Broil Pad** will change the - sign to a positive number or back to a negative number.

Note: Do not change the temperature setting more than 10° before checking the oven.

5. Touch the **Cancel Off Pad** to return to the previous Display.

Important: The oven should be adjusted only 10° and the oven should be tested. (We recommend baking two 9" yellow layer cakes using a purchased box mix.) If the oven temperature is still too low or too high, repeat the procedure described above.

Child Protection Lock

The oven operation controls can be locked in the "**OFF**" position during cleaning or to prevent a child from accidentally turning them on. The oven functions which can be locked in the "**OFF**" position are: Bake, Convect Bake, Convect Roast, Probe, Broil and Clean. The control functions which can always be used regardless of lockout are: Timer, Clock and Oven Light.

To set

Touch and hold the **Cook Time Pad** and the **Stop Time Pad** simultaneously for four seconds. The Indicator Word "**OFF**" will appear and remain in the temperature digits for fifteen seconds.

Note: If an oven function is currently being used, the controls cannot be locked off.

Note: If someone touches an oven function pad, the Indicator Word "**OFF**" will again appear in the temperature digits for fifteen seconds.

To cancel

Touch and hold the **Cook Time Pad** and the **Stop Time Pad** simultaneously for four seconds. The Indicator Word "**OFF**" will appear briefly in the temperature digits and then go off.

Before You Call For Service

Check the following list to be sure a service call is really necessary. A quick reference of this manual may prevent an unneeded service call.

If nothing on the oven operates:

- check for a blown circuit fuse or a tripped main circuit breaker.
- check if oven is properly connected to electric outlet.

If clock, indicator words, and/or lights operate but oven does not heat:

- the controls may have been set incorrectly.
- clock controls may be set for delayed start of oven.
- the Child Protection Lock may have been set.

If the oven light does not work:

- the light bulb is loose or defective.
- oven light does not work during self-cleaning process.

If oven will not go through self-cleaning process:

- controls may be improperly set.
- check the "Clean" and "Stop" time settings and the current time of day on the clock.

If oven did not clean properly:

- oven may need longer cleaning time.
- excessive spills were not removed prior to self-cleaning process.

If oven door will not unlock:

- oven may not have cooled to safe temperature after self-cleaning process.
- electric current coming into the oven may be off.

If foods do not broil properly:

- the control may not be set properly.
- check rack position.
- voltage into house may be low.

If baked food is burned or too brown on top:

- food may be positioned incorrectly in oven.
- oven not preheated properly.

If foods bake unevenly:

- the oven may be installed improperly.
- check the oven rack with a level.
- stagger pans, do not allow pans to touch each other or oven wall.
- check instructions for suggested placement of pans on oven rack.

If oven baking results are less than expected:

- the pans being used may not be of the size or material recommended for best results.
- there may not be sufficient room around sides of the pans for proper air circulation in the oven.
- check instructions for preheating, rack position and oven temperature.

If baking results differ from previous oven:

- oven thermostat calibration may differ between old and new ovens. Follow recipe and use and care directions before calling for service since the calibration on the previous oven may have drifted to a too high or too low setting. (See p. 34 - Adjusting Oven Temperature.)

If the cooling fan continues to operate after the oven has been turned off:

- this is normal and the fan will automatically shut off when the oven is cooled.

If a fan is heard while using the bake mode:

- this is the cooling fan and is normal. The fan will continue to run after use until the oven cools.

If probe does not work:

- check to be sure probe plug is properly inserted into oven receptacle.
- probe may not be positioned in food properly.
- probe temperature may have been improperly set.

Fault Codes

- Fault codes are shown in the Display as "F" and a number. If a fault code appears in the Display and a continuous beep sounds, touch the **Cancel Off Pad**. If the fault code reappears, disconnect power to the oven and call an authorized Jenn-Air Service Contractor.

If You Need Service:

- Call the dealer from whom your appliance was purchased or call Jenn-Air Customer Assistance at 1-800-688-1100, USA and Ontario, or 1-423-472-3333 to locate an authorized service company.
- Be sure to retain proof of purchase to verify warranty status. Refer to WARRANTY for further information of owner's responsibilities for warranty service.
- If the dealer or service company cannot resolve the problem, write to Jenn-Air Customer Assistance c/o Maytag Customer Service, P.O. Box 2370, Cleveland, TN 37320-2370, or call **1-800-688-1100** or **1-423-472-3333**. When contacting Customer Assistance be sure to provide the model and serial numbers of your appliance, the name and address of the dealer from whom you purchased the appliance, and the date of purchase.
- Should you still have a problem, write to the Major Appliance Consumer Action Program, 20 North Wacker Drive, Chicago, IL 60606. MACAP is an industry sponsored but independent group of consumer experts who receive and act on complaints from appliance owners.
NOTE: When writing about an unresolved service problem, please include the following information:
 - a. Your name, address and telephone number;
 - b. Model number and serial number;
 - c. Name and address of your dealer and date the appliance was bought;
 - d. A clear description of the problem you are having.
- User's guides, service manuals and parts catalogs are available from Jenn-Air Customer Assistance.



403 WEST FOURTH STREET NORTH • PO BOX 39 • NEWTON, IA 50208

Printed in U.S.A.
©1997 Jenn-Air

Part No. 8111P343-60

Cat. No. OU30400UF
9/97

Free Manuals Download Website

<http://myh66.com>

<http://usermanuals.us>

<http://www.somanuals.com>

<http://www.4manuals.cc>

<http://www.manual-lib.com>

<http://www.404manual.com>

<http://www.luxmanual.com>

<http://aubethermostatmanual.com>

Golf course search by state

<http://golfingnear.com>

Email search by domain

<http://emailbydomain.com>

Auto manuals search

<http://auto.somanuals.com>

TV manuals search

<http://tv.somanuals.com>