

***iRobot***<sup>®</sup>

**Roomba**<sup>®</sup>

**Vacuum Cleaning Robot**

**700 series  
Owner's Manual**

## Dear Roomba owner,

Thank you for choosing a new generation iRobot Roomba vacuum cleaning robot. You're joining a very special community of people - 5 million worldwide and growing - who are discovering just how useful, convenient and straightforward having a home robot is. In fact, owners tend to like their Roomba so much they've even given them nicknames.

We're passionate about our robots too. Not surprisingly, given that making robots is all we've ever done in the 20 odd years of our existence.

Now, you're probably itching to give your Roomba a go, but it's worth having a quick read of this manual first. That way it will be even easier to use and save you even more time.

I hope you will have many enjoyable experiences with your Roomba and on behalf of all the team thank you for choosing iRobot.

Best Wishes



Colin Angle  
Chairman, CEO and Co-Founder, iRobot Corporation

---

## Looking after your iRobot Roomba

### Every little bit helps

For best results, use it often! After every use, empty the bin and clean the filter. The brushes do a lot of the hard work, so just like a hair brush, every week or so it's best to take them out and remove the hair and fluff that collect around these, and under the brush bearings (see diagrams in Essential Maintenance section).

Extend the battery life by recharging it as soon as possible and storing your Roomba plugged in. For long-term storage, remove and store the battery in a cool, dry place.

**\*Safety first\*** As your Roomba contains electrical parts, don't submerge or spray it with water – clean with a dry cloth only. Before using your product for the first time please refer to the important safety instructions towards the end of this manual.

## How to get started

Before you first use your Roomba, turn it upside down and remove the battery pull tab. To set the clock see page 7. Use the Home Base™ to charge the battery overnight.

### Preparing your cleaning area

Your Roomba is pretty smart in getting around, but it does need a little help. Carpet tassels aren't a problem, but clear away any clutter and loose cables. General dust, dirt and grime are what it's there for, but avoid anything wet.

### Setting Roomba up

First, set up the Home Base™. To keep your Roomba on track, set up Virtual Walls or Auto Virtual Walls, which block off areas, or Virtual Wall® Lighthouses™ (models 780 and above only), to enable room-to-room cleaning.

### Ready to Go!

If you have one, set up your Wireless Command Center or your Remote Control. Otherwise, just start up your Roomba manually:

- Press CLEAN once to turn it on. You'll hear a beep and the CLEAN button will light up. To set the clock see page 7.
- Press CLEAN again to start a cleaning cycle.
- When on the Home Base, simply press CLEAN.
- To pause while cleaning, press CLEAN.
- To resume, press CLEAN again.
- To turn off, press and hold the CLEAN button until the lights turn off.

Then just walk away and let your Roomba get to work.

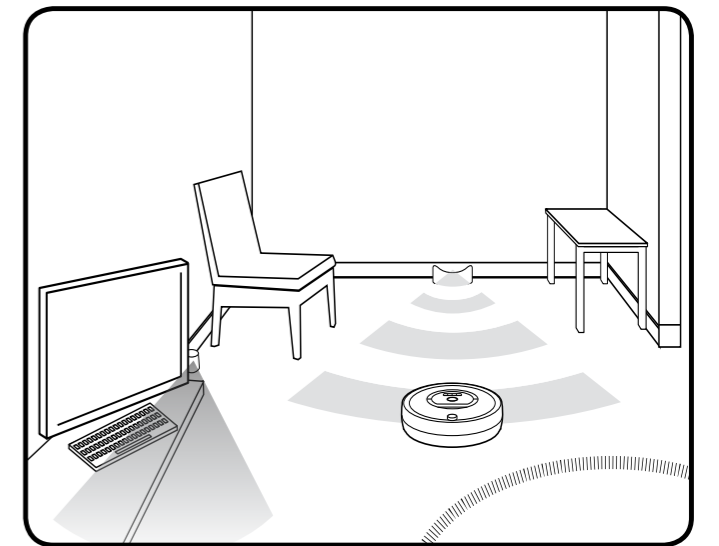
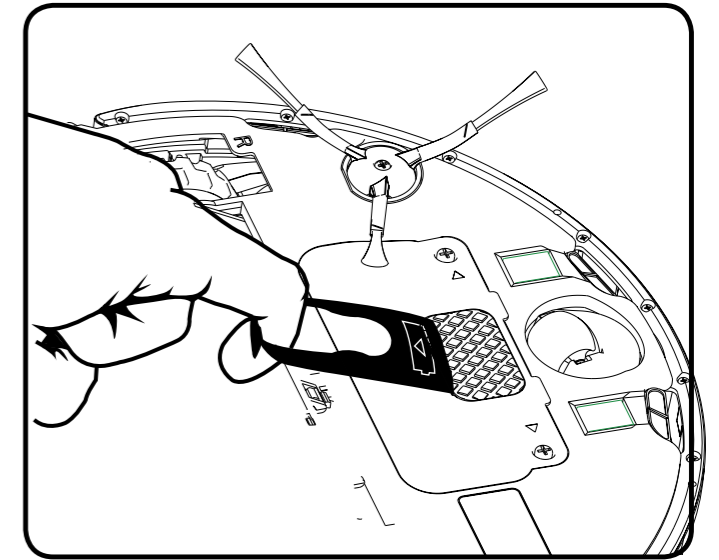

## Cleaning Modes and Pattern

Roomba uses iAdapt™ Responsive Cleaning Technology, an advanced, proprietary system of software and sensors. iAdapt allows Roomba to actively monitor the cleaning environment more than 60 times per second and respond with over 40 different mobility behaviors to clean the room more thoroughly.

### Roomba 700 Series has 3 cleaning modes you can select:

**Clean Mode** – Roomba automatically calculates the room size and adjusts its cleaning time appropriately.

**Spot Mode** – Roomba will spiral approximately 3 feet (1 meter) in diameter and then spiral back to where it started – an intense, localized clean for those quick fixes.

**Scheduled Cleaning Mode** – Roomba leaves its Home Base, cleans, and then returns to recharge when it's done.

## Surfaces

Your Roomba works on pretty much anything – wood, carpet, tile, vinyl and linoleum, adjusting to different floor types. It automatically senses stairs and other drops. It might stall when confronting round edges and might slide over particularly slippery surfaces. Very dark floors may impede its sensors. Roomba is not designed for use outdoors.

## Anti-tangle system

Roomba won't get caught up in tassels or fringes. If it senses a tangle, it automatically stops its brushes and spins them in reverse to free itself.

## Home Base

Position the Home Base on a hard, level surface against a wall. Make sure it's at least 4 feet (1.5 meters) from any stairs and that your Roomba has a clear path to reach it.

When Roomba has finished cleaning, it will return to its Home Base to charge. The light on the Home Base stops blinking and turns solid green when Roomba makes a good connection. Then, Roomba's battery indicator will pulse amber to show it is charging, and will turn solid green when Roomba is fully charged and ready to clean again!

## Virtual Wall®

Optional accessory for all models.

Virtual Walls create an invisible barrier that your Roomba won't cross. That makes it easy to confine it to a particular room or area, and prevent it from getting too close to anything delicate or dangerous.

- Each Virtual Wall needs two C alkaline batteries (not included).
- You can set the Virtual Walls to block an opening of up to 7 feet (2 meters). It creates a cone shape barrier, so the beam gradually gets wider.
- For best results, place the Virtual Wall on the outside of the doorway you want to block. Point the arrows on the top towards the opening.

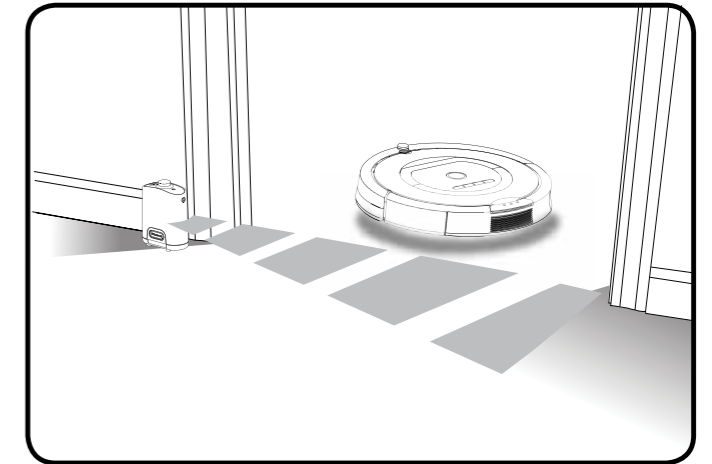

## Manual Virtual Wall

- Turn on a Manual Virtual Wall by hand at the beginning of the cleaning cycle. It will shut off after 135 minutes. If the power light blinks green, it means you'll need new batteries soon.

## Auto Virtual Wall

- When an Auto Virtual Wall is set to "AUTO" mode, the power light continuously blinks to indicate it is on. When battery levels are low, the Virtual Wall continuously blinks twice to indicate that it needs new batteries. When in AUTO mode, the batteries should last for around six months. To save on batteries, just switch it to OFF.

## Virtual Wall Lighthouse™

Accessory for models 780 and above only.

A Virtual Wall Lighthouse can act as both a Virtual Wall and a Lighthouse. In Lighthouse mode, it helps your Roomba navigate around your home. In Virtual Wall mode, it blocks off areas you don't want cleaned.

Simply use the Mode Selector to make your choice. Either way, it turns on and off automatically as you turn your Roomba on and off. When on, the light on top is lit.

Each Virtual Wall Lighthouse needs two C alkaline batteries (not included). A flashing power light means the batteries need replacing soon.



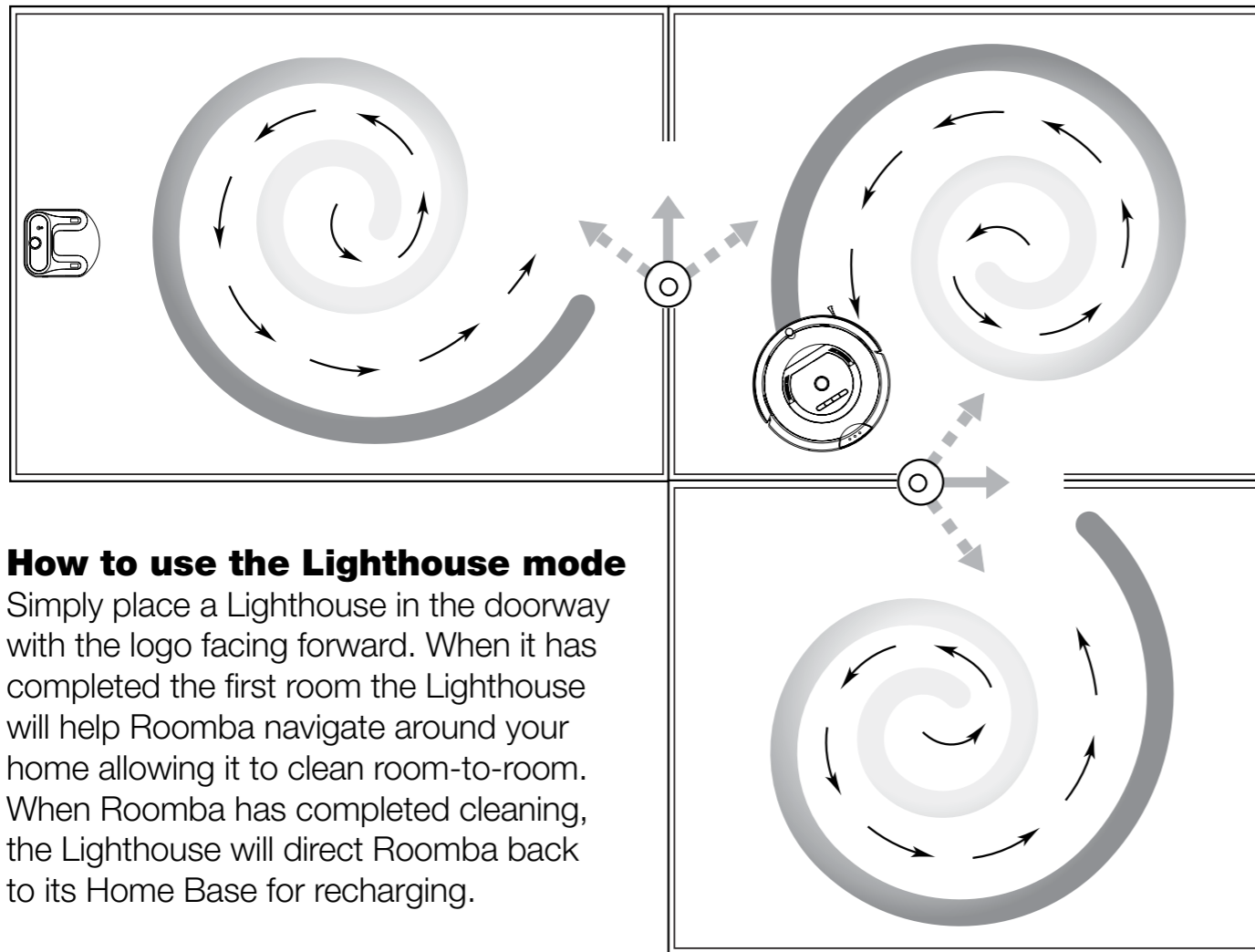

### How to use the Lighthouse mode

Simply place a Lighthouse in the doorway with the logo facing forward. When it has completed the first room the Lighthouse will help Roomba navigate around your home allowing it to clean room-to-room. When Roomba has completed cleaning, the Lighthouse will direct Roomba back to its Home Base for recharging.

You can use Lighthouses and Virtual Walls at the same time, but avoid placing them too close to each other, to the Home Base, or to furniture that could block the invisible beams. Otherwise your Roomba might not recognize the Lighthouses or be able to return to Home Base.

### How to use the Virtual Wall mode

In Virtual Wall mode, the Lighthouse creates an invisible barrier that your Roomba won't cross. It automatically turns off when your Roomba is turned off.

Simply place the Virtual Wall Lighthouse in the center of the doorframe. Unlike a Virtual Wall, a Virtual Wall Lighthouse features a range selector that you can use to adjust the length of the barrier – up to 8 feet (2 meters) – (a longer range will drain the battery faster).

## Battery storage and charging

Your Roomba is powered by a rechargeable battery. Before using your Roomba for the first time, you'll need to charge the battery overnight.

- Make sure your Roomba is fully charged before each cleaning cycle.
- **For maximum battery life**, always store your Roomba plugged in.
- When your Roomba is on the Home Base, make sure the Home Base power light is on.
- If you return your Roomba to the Home Base / battery charger after leaving it off for a long time, it will start a special Refresh Charge mode and the battery indicator will pulse quickly. If possible, don't interrupt the Refresh Charge mode.
- For long-term storage, fully charge the battery, remove, and store it in a cool, dry place.

### How to remove your battery

If you won't be using your Roomba for an extended period, we recommend that you remove the battery. To access the battery, turn Roomba over and remove the two screws that hold Roomba's battery cover in place.

### User Interface Icons

Icon	What does it mean?
	The Anti-tangle Indicator turns on while Roomba is freeing itself from a tangle.
	The Dirt Detect Indicator flashes when dirt is detected and persistent pass cleaning pattern is initiated.
	The Troubleshooting Light blinks when there is an issue (see pages 11 and 12).
	The Full Bin Indicator (models 770 and above) lets you know when the dust bin is full and needs to be emptied.
	The Battery Indicator shows the battery status. Solid red --- Battery drained Amber pulse --- Charging Solid green --- Fully charged Quick amber pulse --- Refresh Charge mode

## Remote Control

You use this just like your TV remote, pointing and clicking it to turn your Roomba on and off, steer it, and control the SPOT and DOCK (...) functions.

- First, install 2 AA batteries (not included).
- If you use it near a Virtual Wall or the Home Base, it may get confused and not work.

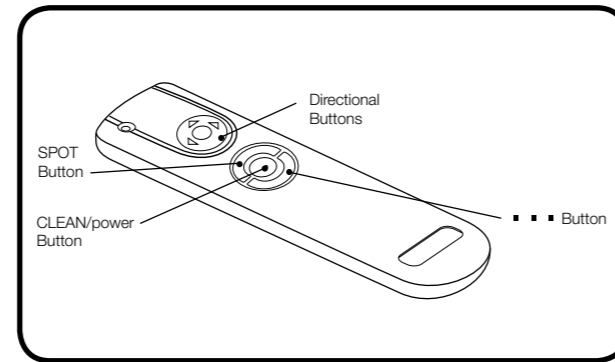

## Wireless Command Center

Optional accessory for models 780 and above.

Use this to turn your Roomba on and off, schedule up to seven cleaning times a week and steer it.

## Scheduling your Roomba

This lets you tell your Roomba exactly when to clean, even when you're away from home. You can schedule Roomba to clean once per day, up to seven times per week.

## Setting the time

1. Turn ON your Roomba by pressing CLEAN.
2. Press CLOCK.
3. Use DAY, HOUR and MINUTE individually to set the correct time.
4. Press OK to save changes. To exit or cancel press CLEAN and start again.

## Setting 12 / 24 hr

To switch between the two views, press and hold CLOCK until the display shows 12h or 24h. Then press CLOCK to switch and press OK to save changes.

Roomba's clock will switch back to the default 12 hour (AM/PM) format when Roomba's battery is disconnected or significantly discharged.

## Setting a schedule

You can schedule your Roomba to clean once a day, up to seven times a week. You must set the internal clock before setting a schedule.

1. Turn ON your Roomba by pressing CLEAN.
2. Press SCHEDULE.
3. Use DAY, HOUR and MINUTE individually to set the schedule.
4. Press OK to save changes. To exit or cancel press CLEAN and start again.

## Viewing a schedule

1. Turn ON your Roomba by pressing CLEAN.
2. Press SCHEDULE.
3. Press DAY to look through the scheduled cleaning times.
4. Press OK to save changes. To exit or cancel press CLEAN.

## Deleting a schedule

1. Turn ON your Roomba by pressing CLEAN.
2. Press SCHEDULE.
3. Press DAY to look through the scheduled cleaning times.
4. When your Roomba is displaying the scheduled cleaning time you want to delete, press HOUR until --:-- is displayed. Press OK to save changes.
5. To delete all schedules, press DAY for 5 seconds.

## Changing a schedule

1. Turn ON your Roomba by pressing CLEAN.
2. Press SCHEDULE.
3. Press DAY to look through the scheduled cleaning times.
4. When your Roomba is displaying the scheduled cleaning time you want to change, press HOUR and MINUTE individually to make the change.
5. Press OK to save changes. To exit or cancel press CLEAN.

## A little maintenance goes a long way

To keep your Roomba working perfectly, it's a good idea to do a little maintenance regularly. In particular, please note the following:

- Look for the yellow parts – these are designed to be removed and cleaned.
- You should empty the bin and clean the brushes after each use, if possible.
- Excessive hair build-up could permanently damage your Roomba or your floor, so clean the brush bearings and brush caps regularly.



## Essential maintenance

### Emptying the bin

You should do this after each use. Ensure proper insertion of the bin each time as Roomba will not run without it.

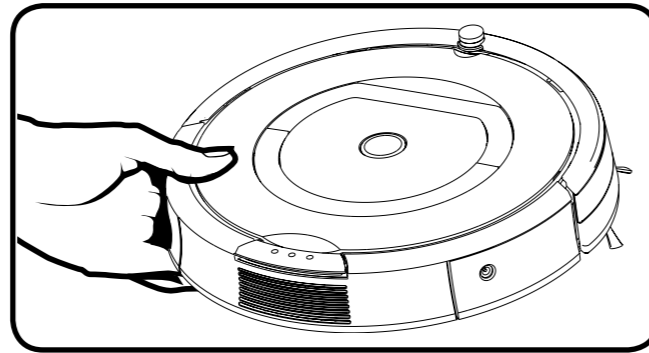

### Cleaning the two filters

Regular cleaning is important and you should replace the filters after two months of regular use.

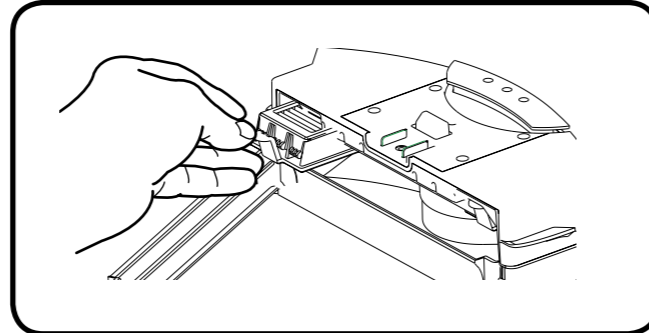

### Cleaning the brushes and associated parts

1. Remove brush guard by lifting both yellow tabs.

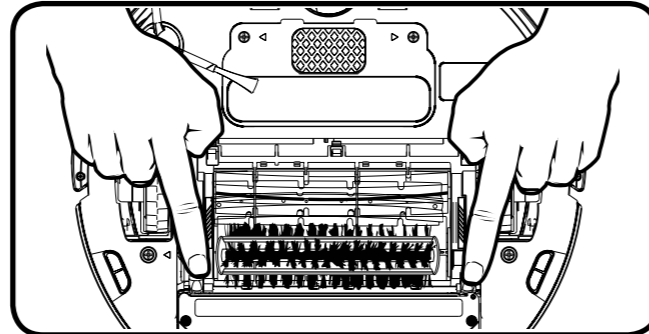

2. Remove and clean the two brushes and brush bearings.

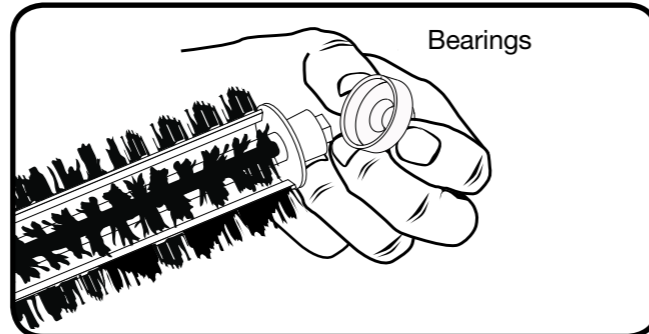

3. Use the included cleaning tool to remove hair easily from the bristle brush by pulling it over the brush.

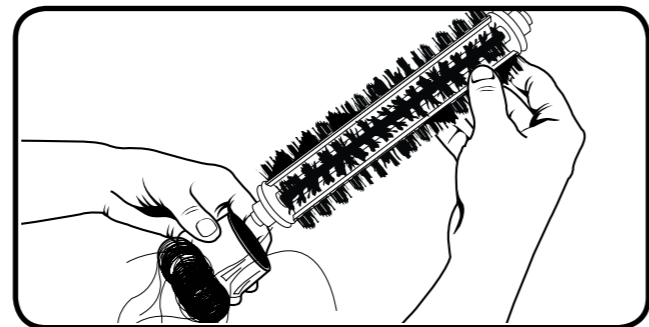

4. To clean the side brush, use a small Phillips screwdriver to remove the screw from the center. Remove the brush, clean, reinstall.

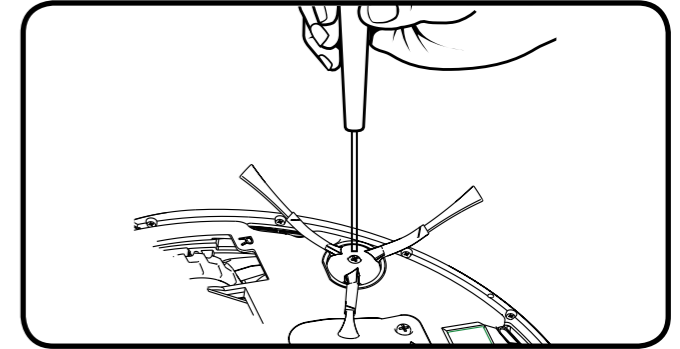

### Cleaning the front wheel

1. Pull firmly on the front wheel to remove it.
2. Remove any debris from inside the wheel cavity.
3. Remove the wheel from its housing and wipe clean. Pull firmly to remove the axle and clear any hair wrapped around it.
4. Reinstall all parts when finished. Make sure the wheel clicks right back into place.

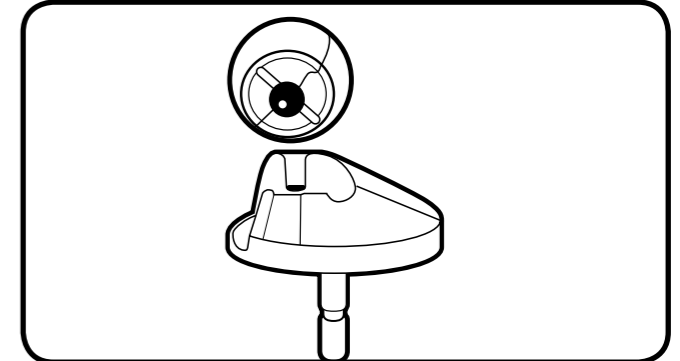

### Cleaning the bin sensors (models 770 and above only)

Remove the bin and wipe the two optical bin sensors with a clean, dry cloth.

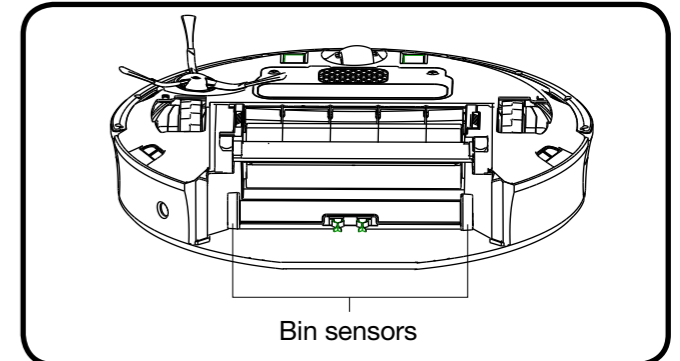

### Cleaning the cliff sensors

Simply wipe all six cliff sensor openings with a clean, dry cloth.

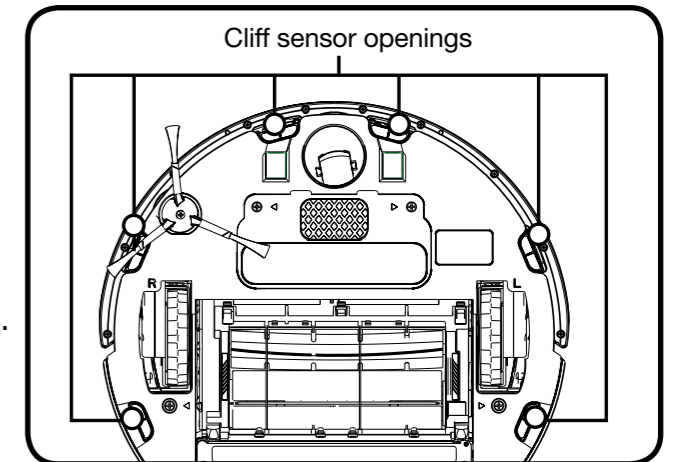

### Troubleshooting

Occasionally, something can go wrong. But don't worry – there's an early warning system.

Your Roomba will tell you what the problem is. The troubleshooting light will also blink. To repeat an error message, just press CLEAN.

For more information you can download a detailed user manual at [www.irobot.com](http://www.irobot.com)

## Problems while cleaning

Your Roomba blinks and says...	Likely cause	What to do
Error 1. Move Roomba to a new location then press CLEAN to restart.	Your Roomba is stuck with a wheel hanging down.	Ensure your Roomba's wheels are firmly on the floor. Start in a new location.
Error 2. Open Roomba's brush cage and clean brushes.	Your Roomba's main brushes can't turn.	Remove and clean your Roomba's brushes.
Error 5. Spin Roomba's side wheels to clean.	Your Roomba's side wheel is stuck.	Clean your Roomba's side wheels. Push them in and out and check that they both turn freely. Start in a new location.
Error 6. Move Roomba to a new location then press CLEAN to restart.	Your Roomba's cliff sensors are dirty or your Roomba is hanging over a drop.	Wipe your Roomba's cliff sensors with a dry cloth. Start in a new location.
Error 7. Spin Roomba's side wheels to clean.	Your Roomba's side wheel is stuck.	Clean your Roomba's side wheels of hair and debris. Push them in and out and check that they both turn freely. Start in a new location.
Error 9. Tap Roomba's bumper to clean.	Your Roomba's bumper is compressed or the bumper sensor is dirty.	Briskly tap your Roomba's bumper several times to dislodge any debris that may be trapped underneath.
Error 10. Spin Roomba's side wheels to clean.	Your Roomba's side wheel is stuck or its bumper isn't detecting obstacles.	If your Roomba is circling in one place, clean side wheels. Push them in and out and check that they both turn. If it's not circling in one place, Roomba may be in a very large room. Use a Virtual Wall to create a smaller cleaning area.
Please charge Roomba.	Your Roomba's battery is dead.	Plug your Roomba into the charger or place it on the Home Base to charge.

## Problems while charging

Your Roomba blinks...	Your Roomba displays...	Your Roomba says...	Likely cause...	What to do
<b>1 blink</b>	-	Charging error 1	Your Roomba's battery isn't connected.	Check that you removed pull-tab from the battery. Remove the battery cover of your Roomba to remove & reinstall battery.
<b>2 blinks</b>	Err 2	Charging error 2	Your Roomba has a charging error.	Let your Roomba cool down for at least an hour & try charging again.
<b>3 blinks</b>	Err 3	Charging error 3	Your Roomba has a charging error.	Reset Roomba's software (pg13) and try charging again.
<b>5 blinks</b>	Err 5	Charging error 5	Your Roomba has a charging error.	Reset Roomba's software (pg13) and try charging again.
<b>6 blinks</b>	Err 6	Charging error 6	Your Roomba has a charging error.	Let your Roomba cool down for at least an hour & try charging again.
<b>7 blinks</b>	Err 7	Charging error 7	Your Roomba's battery isn't cooling.	Let your Roomba cool down for at least an hour & try charging again.

### Language selection mode

Your Roomba can provide troubleshooting messages in English, French, German, Spanish, Italian, Dutch, Danish, Swedish, Norwegian, Finnish, Polish, Russian, Portuguese, Japanese, Korean and Chinese.

### Setting the language

The default language is English. To change this:

1. Turn ON your Roomba by pressing CLEAN.
2. Press and hold DOCK until it beeps and says the current language.
3. Release DOCK.
4. Now press CLEAN repeatedly until you hear the language you want.
5. Press and hold CLEAN to turn off your Roomba and confirm language choice.



## How to reset the software

Hold down CLEAN for ten seconds. This will clear the clock and may disrupt successful docking for the first few charge cycles.

## Frequently asked questions

### Why does my Roomba's side brush occasionally spin backwards?

When caught on items such as carpet tassels or wires, the side brush may spin slowly or even backwards to free itself. This may also occur on thick carpets. If it does this at other times, you should clean the brush.

### Why does my Roomba occasionally make a thumping sound?

When Roomba's brushes encounter items such as carpet tassels or wires, the brushes will briefly reverse direction to get free. This makes a thumping sound. If you hear a thumping sound at any other time, you should clean the main brushes.

### Why doesn't my Roomba slow down as it approaches certain obstacles?

Your Roomba usually identifies obstacles quickly, allowing it to slow down and gently touch the obstacle with its bumper before changing direction. However, it may be less effective at sensing extremely dark surfaces, or objects under 2 inches (5 centimeters) wide.

## Important safety instructions

CAUTION: DO NOT EXPOSE THE ELECTRONICS OF ROOMBA, ITS BATTERY, OR THE BATTERY CHARGER. THERE ARE NO USER SERVICEABLE PARTS INSIDE. REFER SERVICING TO QUALIFIED SERVICE PERSONNEL. PLEASE ENSURE VOLTAGE RATING FOR ENCLOSED BATTERY CHARGER MATCHES STANDARD OUTLET VOLTAGE. Always exercise caution when operating your Roomba. To reduce the risk of injury or damage, keep these safety precautions in mind when setting up, using and maintaining Roomba:

### General

- Read all safety and operating instructions before operating Roomba.
- Retain the safety and operating instructions for future reference.
- Heed all warnings on Roomba, Battery, AC Adapter and in Owner's Manual.
- Follow all operating and use instructions.
- Refer all non-routine servicing to iRobot.

### Roomba use

- Roomba is for indoor use only.
- Roomba is not a toy. Do not sit or stand on this device. Small children and pets should be supervised when Roomba is cleaning.
- Clean with a dry cloth only. Do not pour or spray liquids onto Roomba.
- Do not use this device to pick up anything that is burning or smoking.
- Do not use this device to pick up spills of bleach, paint, or other chemicals, or anything wet.
- Before using this device, pick up objects like clothing, loose papers, pull cords for blinds or curtains, power cords, and any fragile objects. If the device passes over a power cord and drags it, there is a chance an object could tumble off a table or shelf.
- If the room to be cleaned contains a balcony, a physical barrier should be used to prevent access to the balcony and ensure safe operation.

- Always remove the battery before long-term storage or transportation.
- This appliance is not intended for use by persons (including children) with reduced physical, sensory or mental capabilities, or lack of experience and knowledge, unless they have been given supervision or instruction concerning use of the appliance by a person responsible for their safety.
- Children should be supervised to ensure they do not play with the appliance.

### Roomba battery pack and charging

- Charge using a standard outlet only. Product may not be used with any type of power converter. Use of other power converters will immediately void the warranty.
- Use only the battery charger supplied by the manufacturer to charge this device.
- Do not use a battery charger with a damaged cord or plug.
- Charge indoors only.
- Roomba's battery charger may be protected with a surge protector in the event of severe electrical storms.
- Never handle the battery charger with wet hands.
- Always disconnect Roomba from the battery charger before cleaning.
- Please ensure voltage rating for enclosed battery charger matches standard outlet voltage.

## What if I need further help or accessories?

### iRobot Customer Care USA

If you have questions or comments about Roomba, please contact iRobot before contacting a retailer. Please visit our web site at [www.irobot.com](http://www.irobot.com) for support tips, frequently asked questions, or information about accessories and other iRobot products. We would like to hear from you.

### Should you still need assistance:

- Visit the iRobot support web site at [www.irobot.com/support](http://www.irobot.com/support)
- Call our customer care representatives at 877.855.8593

### iRobot Customer Care Hours:

- Monday – Friday 9AM – 7PM Eastern Time
- Saturday 9AM – 6PM Eastern Time

### iRobot Customer Care International

To contact an international partner near you for sales and technical support, visit [www.irobot.com/international](http://www.irobot.com/international).





.....

## Declaration of conformity

iRobot Roomba ® Vacuum Cleaning Robot and Accessories

Manufacturer: iRobot Corporation, 8 Crosby Drive, Bedford, MA 01730, USA

Declares that Roomba along with Model 17062 and 17063 Battery Chargers and the Home Base, conform to the requirements of:

Low Voltage Directive 73/23/EEC as amended by 93/68/EEC and EMC Directive 89/336/EEC as amended by 92/31/EEC.

It is further declared that the Roomba and Roomba SE Robotic Vacuum Cleaner and Accessories conform to the following harmonised European standards:

Year of CE Marking: 2004

EN 60335-1:2002 + A11:2004

Household and Similar Electrical Appliances - Safety Part 1 - General Requirements

EN 60335-2-2:2003

Household and Similar Electrical Appliances - Safety Part 2 - Particular Requirements for Vacuum Cleaners and Water-Suction Cleaning Appliances

EN 60335-2-29:2002

Household and Similar Electrical Appliances - Part 2-29 - Particular Requirements for

Battery Chargers

EN 55014-1:2000 + A1:2001 + A2:2002

Electromagnetic compatibility - Requirements for household appliances, electric tools and similar apparatus -- Part 1: Emission

EN 55014-1:1997 + A2:2002

Electromagnetic compatibility - Requirements for household appliances, electric tools

and similar apparatus -- Part 2: Immunity - Product family standard

Low Voltage tests and EMC tests have been conducted by:

TUV Rheinland of North America

This equipment has been tested and found to comply with the limits for a Class A digital device, pursuant to part 15 of the FCC Rules.

These limits are designed to provide reasonable protection against harmful interference when the equipment is operated in a commercial environment. This equipment generates, uses, and can radiate radio frequency energy and, if not installed and used in accordance with the instruction manual, may cause harmful interference to radio communications. Operation of this equipment in a residential area is likely to cause harmful interference in which case the user will be required to correct the interference at his own expense.

## ***iRobot***

© 2010-2011 iRobot Corporation, 8 Crosby Drive, Bedford, MA 01730. All rights reserved.

iRobot, Roomba and Virtual Wall are registered trademarks of iRobot Corporation. Dirt Detect, Home Base and Lighthouse are trademarks of iRobot Corporation. [00256.1210.v1]

U.S. Pat. Nos. D556,961 | 6,594,844 | 6,690,134 | 6,809,490 | 6,883,201 | 6,956,348 | 7,155,308 | 7,173,391 | 7,196,487 | 7,288,912 | 7,288,912 | 7,332,890 | 7,388,343 | 7,389,156 | 7,429,843 | 7,430,455 | 7,441,298 | 7,448,113. Additional patents pending.

## Free Manuals Download Website

<http://myh66.com>

<http://usermanuals.us>

<http://www.somanuals.com>

<http://www.4manuals.cc>

<http://www.manual-lib.com>

<http://www.404manual.com>

<http://www.luxmanual.com>

<http://aubethermostatmanual.com>

Golf course search by state

<http://golfingnear.com>

Email search by domain

<http://emailbydomain.com>

Auto manuals search

<http://auto.somanuals.com>

TV manuals search

<http://tv.somanuals.com>