

# iRobot® Scooba® OWNER'S MANUAL



.....  
**SAVE 15%**  
on accessories.

See back for details.  
.....



# **iRobot®**

Dear iRobot® Scooba® Owner,

Congratulations and welcome to the world of iRobot! You have joined the growing number of people who have discovered a smarter way to clean.

iRobot Scooba is an innovative and easy-to-use product that will change the way you clean hard floors. Scooba frees you to manage other household tasks while it cleans, so you can wash your hard floors more frequently and get more done.

Please take a few moments to review this manual to get acquainted with Scooba. Should you have any further questions, visit our website at [www.irobot.com](http://www.irobot.com).

iRobot Corporation prides itself on listening to its customers, and we would like to hear from you. Please register your Scooba and tell us about your experience with your robot.

You can easily register your Scooba at **[www.irobot.com](http://www.irobot.com)**. By registering your robot, you're guaranteed to be notified of any product upgrades. **Plus you will receive 15% off your first order of cleaning solution and other accessories at [www.irobot.com](http://www.irobot.com).**

Thank you for joining the iRobot revolution. We look forward to bringing you more groundbreaking products that will change and improve your world.

On behalf of the entire iRobot team,



Colin Angle  
Co-Founder and CEO  
iRobot Corporation

# Important Tips

**⚠ Use only the recommended amount of Scooba cleaning solution or vinegar. Other fluids may corrode electronic parts, cause excessive foaming, or create poor traction and will void the warranty. See page 14 for details.**

**⚠ Do NOT use bleach in Scooba. Bleach may damage the robot and will void the warranty.**

**⚠ Scooba contains electronic parts. Do NOT submerge Scooba or spray with water. Clean with a damp cloth only.**

**⚠ Store or operate Scooba in room temperature environments only, freezing may damage Scooba.**

**⚠ Scooba is not recommended for use on unfinished or unsealed wood or pre-laminated flooring, which can easily be damaged by wet cleaning methods.**

**⚠ Always consult your floor manufacturer for approved cleaning methods.**

## For Best Performance

**TIP: Scooba is designed to work with 1.5 ounces of Scooba cleaning solution or 2 ounces of white vinegar and water. You also can use Scooba with plain tap water.**

- Remove furniture, clutter, and lightweight rugs from area to be cleaned.
- Use the Virtual Wall® to contain Scooba to one room.
- Always empty the Dirty tank and Clean tank after the cleaning cycle is complete.
- Rinse the Dirty tank before storage.
- Keep wheels and brush free from hair and debris by inspecting and cleaning the bottom of Scooba regularly.
- Remove and rinse the filter, brush, and vacuum port after each use.
- Always store Scooba plugged-in and recharging.

# Table of Contents

Scooba's Anatomy and Lights .....	6 – 7
Scooba's Cleaning Pattern .....	8
Battery Performance .....	9
Battery Installation and Removal .....	10
Charging Scooba .....	11
Scooba's Tank.....	12 – 13
Scooba's Cleaning System .....	14
Scooba Cleaning Solution formulated by Clorox®.....	15
Scooba's Virtual Wall .....	16
Scooba Maintenance .....	17 – 18
Avoiding Common Mistakes .....	19 – 20
Troubleshooting.....	21 – 24
iRobot Customer Care .....	25
Safety Instructions .....	26 – 27

# Scooba's Anatomy

Scooba has two main parts: the robot base, and the tank.

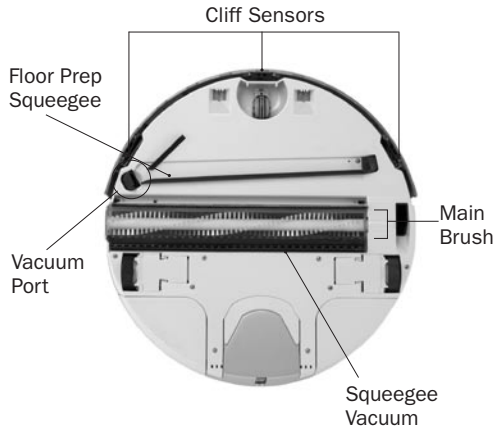
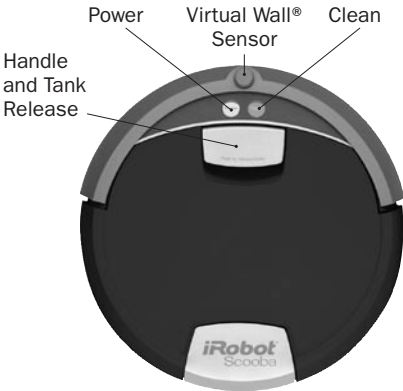

## Robot Base

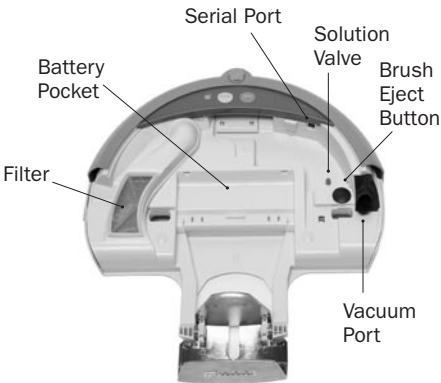

## Scooba's Tank

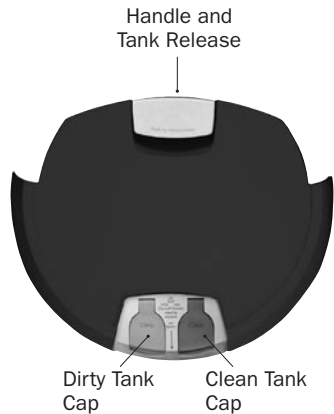

# Scooba's Lights

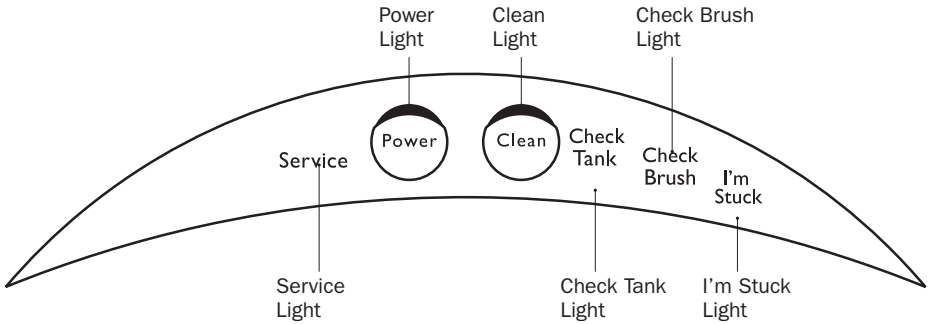

Power Button Light	Battery Status
Red	Battery empty
Green pulsing	Charging
Green solid	Fully charged
Red blinking	Battery not installed

Clean Button Light	What It Means
Green	Cleaning
Green blinking	Scooba is drying its cleaning head; the clean cycle is almost complete

## Warning Lights Quick Reference

See page 18 for detailed instructions.

Warning Lights	What To Do
Check Tank	The cleaning cycle is complete. Empty Scooba's tanks (pages 12 – 13)
Check Brush	Remove and clean brush and filter (page 22)
I'm Stuck	Move and restart Scooba (page 18)

# Scooba's Cleaning Pattern

Scooba is a robot that cleans differently than the way most people clean their floors. Scooba uses iRobot's AWARE™ Robot Intelligence System to determine the best way to pass over and clean every section of the floor.

In most cases, Scooba will pass over the same area of the floor multiple times to ensure a thorough cleaning.

**TIP: For smaller rooms, use less cleaning solution and water. Partially filling the tank will shorten Scooba's cleaning time.**

While Scooba is cleaning it calculates the best path to clean your floor and determines the best times to use its various cleaning behaviors:

**Spiraling:** Enables Scooba to efficiently clean a large area.

**Wall Following:** Enables Scooba to clean the room perimeter and navigate around furniture and obstacles.

**Room Crossing:** Enables Scooba to clean new areas while crisscrossing the room.

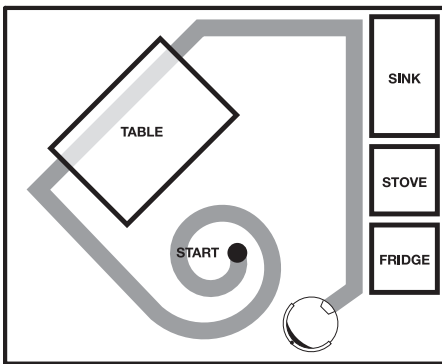

Scooba will alternate between spiraling, wall following, and room crossing during a cleaning cycle.

**TIP: For best performance and floor coverage, clear your floor of chairs, clutter, and light rugs. Use a Virtual Wall to contain Scooba to one room.**



# Battery Performance

Scooba is powered by a rechargeable battery. Scooba's battery will last for hundreds of cleaning cycles before needing replacement.



## **Battery Storage**

For best battery performance, iRobot recommends storing Scooba's battery in Scooba with the power supply plugged in. Do not store Scooba's battery in the robot if the robot is not plugged in.

## **Battery Life**

Fully charge Scooba's battery (up to 4 hours) before each cleaning cycle. When fully charged, Scooba's battery will last for at least one full cleaning cycle. If you would like to run Scooba more frequently, you can purchase additional batteries and chargers at [www.irobot.com](http://www.irobot.com). The battery should be replaced if Scooba cannot complete a cleaning cycle when fully charged.

## **16-Hour Refresh Charge**

Under some circumstances, Scooba uses a special 16-hour charge cycle to extend Scooba's battery life. Scooba will use this charge cycle when the Scooba has been unplugged for an extended period of time or during the battery's first charge. The Power light will rapidly blink green during this charging cycle.

**TIP: For best performance, always store Scooba's battery on a plugged-in charger. Charge Scooba's battery overnight for the first charge.**

# Battery Installation and Removal

## Installing Battery in Scooba

Rotate battery into its slot, making sure the yellow battery tabs fit inside the guide holes. Listen for a click as the battery snaps into place.

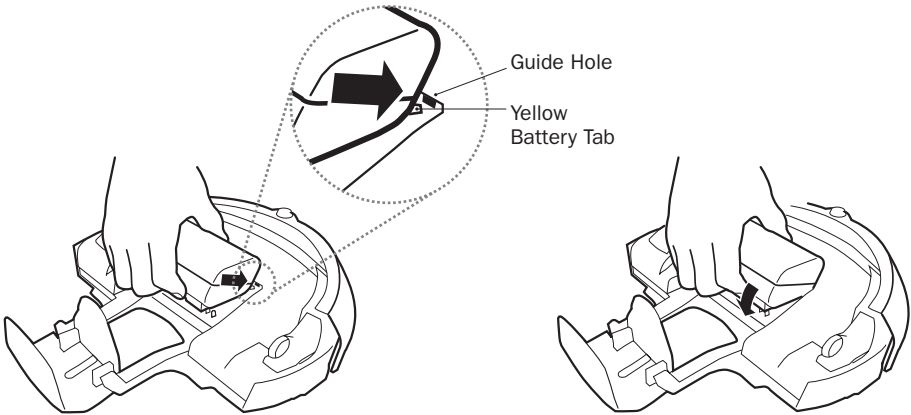

*Insert yellow tabs into guide holes*

*Rotate battery down until it clicks*

## Removing Battery from Scooba

Grip the battery, making sure to push the release tab, then rotate up.

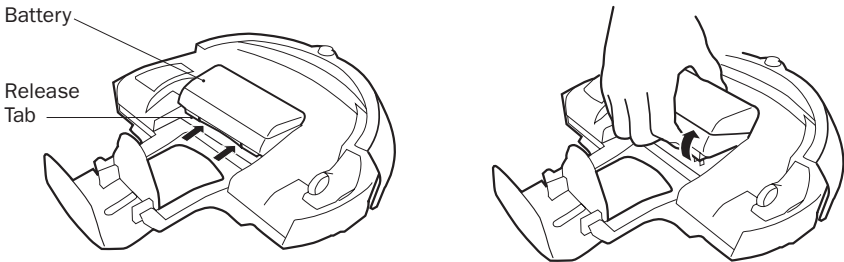

*Push release tab*

*Rotate battery up*

# Charging Scooba

Charge Scooba's battery by plugging the power supply into Scooba. Align the arrow on the power supply with the arrow on the Scooba.

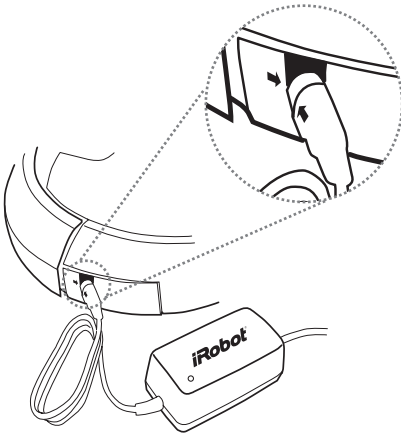

Scooba's Power Light	Battery Status
Red	Battery empty
Green pulse	Charging
Green fast pulse	16-hour refresh charge
Green solid	Fully charged
Red blinking	Battery not installed

**TIP: Always make sure that the green power light of the power supply is ON while plugged into the wall.**

# Scooba's Tank

Scooba's tank is completely removable from the robot base. Scooba has a unique two-chamber tank design that ensures fresh cleaning solution never mixes with the dirty water Scooba picks up as it cleans.

## Clean Tank

The Clean tank holds the cleaning solution and water that Scooba uses to clean the floor. Before each use, the Clean tank is filled with water and 1 measuring cup (1.5 oz.) of Scooba cleaning solution or 2 ounces of white vinegar. Fill the Clean tank before cleaning with Scooba.

- 1** Press handle to remove tank.

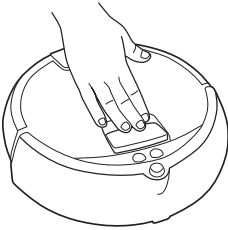

- 2** Remove tank from robot base.

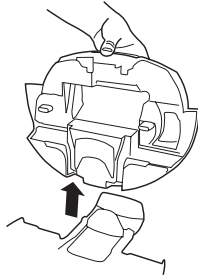

- 3** Using the included measuring cup, measure and pour cleaning solution into the Clean tank.

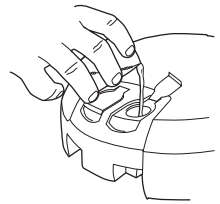

- 4** Slowly fill the remainder of the Clean tank with warm or cold tap water. Tilt the tank to ensure it is completely filled to the top.

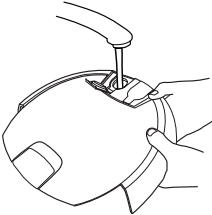

- 5** Push the Clean tank cap closed and place tank back in robot.

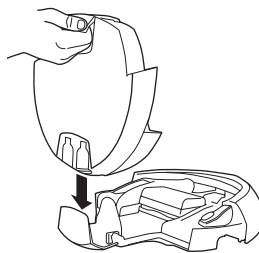

- 6** Push firmly on tank until you hear an audible click.

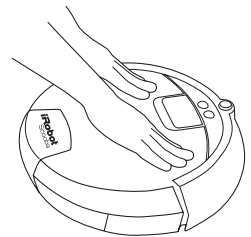

**⚠ CAUTION: Fill with cold or luke-warm water only. Do not fill Scooba's tanks with hot water.**

**⚠ CAUTION: USE ONLY SCOOPA CLEANING SOLUTION OR WHITE VINEGAR. Scooba cleaning solution is specially formulated for Scooba. Other solutions may damage Scooba, causing corrosion of electronic parts, excessive foaming, and poor traction. Use of other solutions will void the warranty. See page 14 for details.**

## Dirty Tank

Scooba puts down clean solution, gently scrubs the floor, and collects all of the dirty solution into the Dirty tank. Empty and rinse the tanks after every cleaning cycle.

- 1** Press handle to release tank.

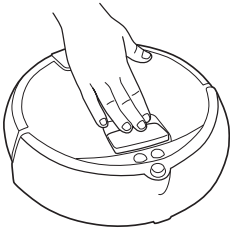

- 2** Remove tank from robot.

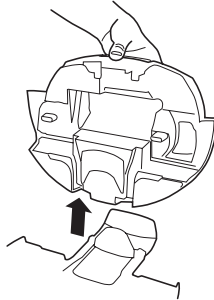

- 3** Empty Dirty and Clean tanks.

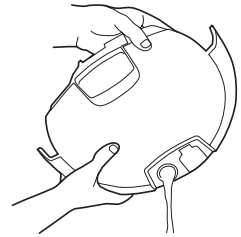

- 4** Rinse Dirty tank with warm water.

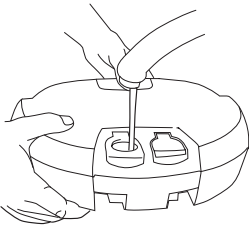

- 5** Remove and rinse Scooba's filter and vacuum port.

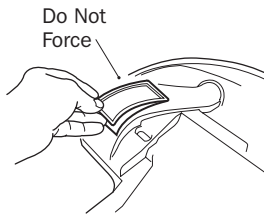

- 6** Place the tank back in Scooba. Push down firmly on the tank until you hear an audible click.

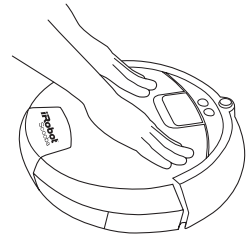

# Scooba's Cleaning System

Scooba uses four cleaning methods in every pass.

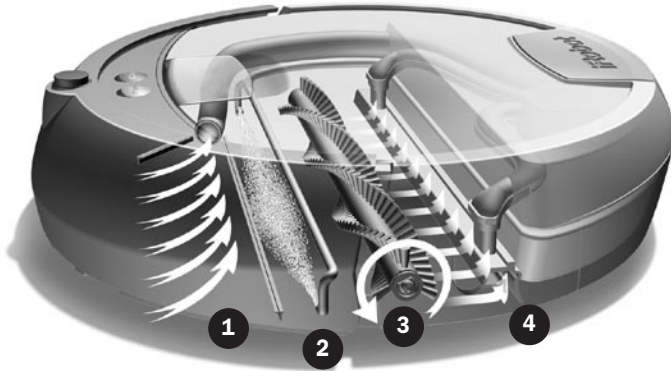

- 1 Preps** – Scooba picks up loose dirt and light debris from the floor. You do not need to sweep the floor before using Scooba unless you have large objects such as pebbles or large food particles on the floor.
- 2 Washes** – Scooba continuously lays down a small amount of fresh cleaning solution.
- 3 Scrubs** – Scooba gently scrubs to clean spills and grime.
- 4 Dries** – Scooba's squeegee vacuum picks up dirty water and debris, leaving your floor clean and dry.

Scooba will clean until it has used all of the solution in the Clean tank, approximately 45 minutes. At the end of a cleaning cycle, Scooba will enter a drying mode.

## Internal Drying Mode

At the end of the cleaning cycle, Scooba will enter a brief internal drying mode to remove any liquid remaining on its brushes and inside its cleaning mechanisms. During this time Scooba's Clean light will blink.

**TIP: If you wish to end a cleaning cycle early, iRobot recommends activating the internal drying mode first:**

- To start drying mode while the robot is cleaning, just press Clean.
- To start drying mode when Scooba is off, press Power and then press Clean twice.

# Scooba Cleaning Solution

## formulated by Clorox®



Scooba cleaning solution is specially formulated by Clorox® to be safe for use in Scooba. The solution is designed to be tough enough for cleaning, but safe around children and pets.

**⚠ CAUTION: Use only Scooba cleaning solution or white vinegar. Other solutions may damage Scooba causing corrosion of electronic parts, excessive foaming, and poor traction. Use of other solutions may damage the robot and voids the warranty. You also can use Scooba with plain tap water.**

Scooba cleaning solution has been specifically engineered to be safe and effective on hard floor surfaces, including tile, linoleum, vinyl, marble, slate, stone, and sealed hardwood.

The solution contains no bleach.

**⚠ CAUTION: DO NOT USE SCOOBA ON THESE SURFACES:**

- Carpet or rugs
- Unsealed hardwood or stone
- Laminate flooring (such as Pergo®)

Scooba is not recommended for use on unfinished or unsealed hard floor surfaces, carpet, rugs or waxed floors. These surfaces may be damaged by water (an unsealed floor does not have a coat of polyurethane to protect the sub-flooring from water damage). Additionally, Scooba is not safe for use with laminate flooring which may be damaged by wet cleaning methods.

**TIP: When using Scooba on sealed hardwood floors, inspect the floor surface for worn finish, bare wood, or separated and unsealed joints. Do not use Scooba on your hardwood floor if any of these conditions exist. Follow the floor manufacturer's cleaning recommendations.**

## Approved Cleaning Solutions

iRobot approves using only Scooba cleaning solution or 2 oz. of white vinegar with Scooba. iRobot does not assume responsibility for floor damage caused by the use of vinegar on hard floor surfaces. Scooba may also be run with plain tap water.

**TIP: Scooba is designed to work with 1.5 ounces of Scooba cleaning solution or 2 ounces of white vinegar and water. You also can use Scooba with plain tap water.**

# Scooba's Virtual Wall®

The Scooba Virtual Wall creates an invisible barrier that Scooba will not cross. Virtual Walls can be set to block areas from three to eight feet wide.



**TIP: Use the Virtual Wall to block doorways or to keep Scooba away from cords.**

The Virtual Wall beam is keyhole shaped. A small halo prevents Scooba from bumping the Virtual Wall and a larger lobe-shaped section blocks off areas of your home where you don't want Scooba to go.

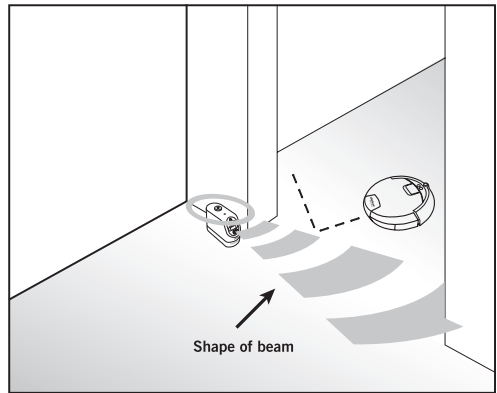

Virtual Walls require 2 "D" batteries. Virtual Walls will automatically shut themselves off at the end of a cleaning cycle.

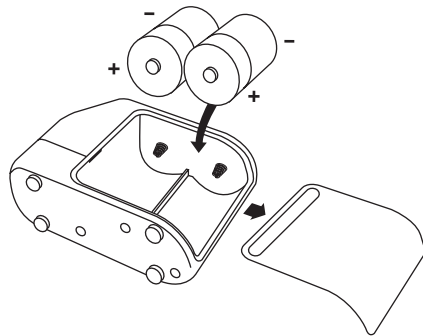

**TIP: For best performance, place the Virtual Wall on the outside of the doorway you wish to block, and always set the Virtual Wall to the shortest setting possible.**



# Scooba Maintenance

To keep Scooba running at peak performance, perform the following maintenance tasks after every cleaning cycle:

## Rinse Scooba's Dirty Tank

- 1 Partially fill the Dirty tank with water.
- 2 Empty and rinse the Dirty tank.

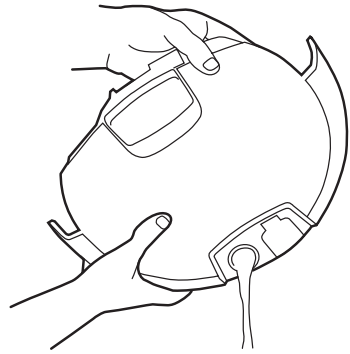
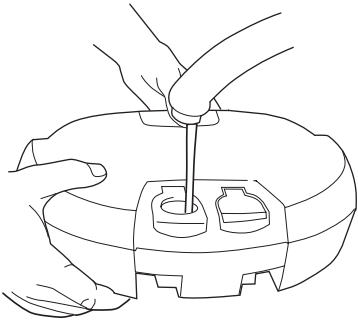

## Clean Scooba's Filter

- 1 Remove filter.
- 2 Rinse under warm water.
- 3 Replace filter.

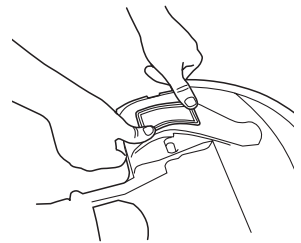
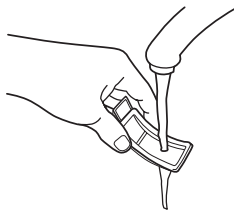
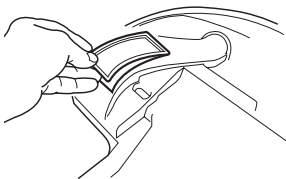

**⚠ CAUTION:** Scooba contains electronic components that can be damaged by spills of water or other liquids. Clean the bottom and top of Scooba with a damp cloth only. Do not pour or spray water onto Scooba, other than into the Clean or Dirty tanks.

## Clean Scooba's Brush After Every Use

Scooba's brush is located inside a cartridge called the "cleaning head". Access to the cleaning head is inside Scooba, so the tank needs to be open when removing and replacing the cleaning head.

- 1 Push the Brush Eject button to remove the cleaning head.

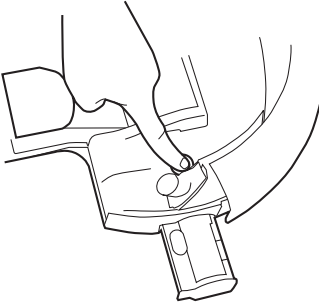

- 2 Open the cleaning head and remove the brush.

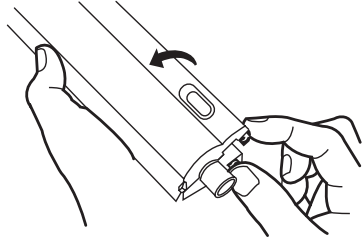

- 3 Rinse cleaning head and brush under warm water.

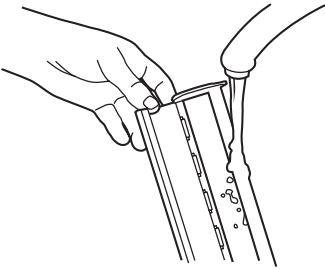

- 4 Replace Scooba's cleaning head.

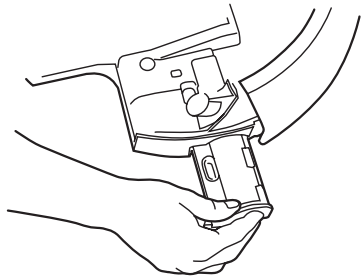

## Rinse Scooba's Vacuum Port After Every Use

- 1 Remove vacuum port.

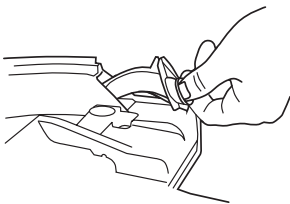

- 2 Rinse under warm water.

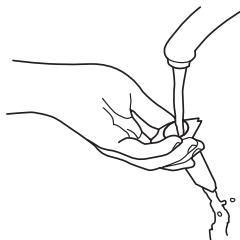

- 3 Replace vacuum port.

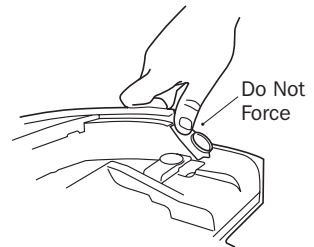

# Avoiding Common Mistakes

Your iRobot Scooba will not clean effectively if the battery, cleaning head, filter or vacuum port are not properly installed. Here are a few common mistakes you can easily avoid to ensure best results.

## Make Sure Battery is Installed Correctly

When the battery is properly installed, the yellow battery tabs should fit into their guide holes.

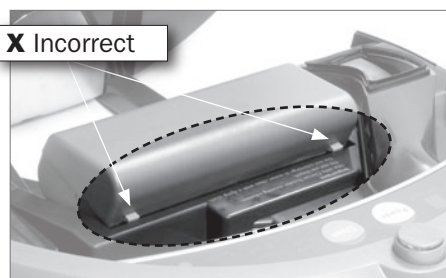
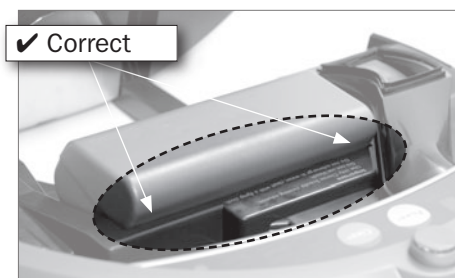

## Click Cleaning Head into Place

When the cleaning head is properly installed, you should hear it click into place. For best results, push down on the robot base while installing the cleaning head.

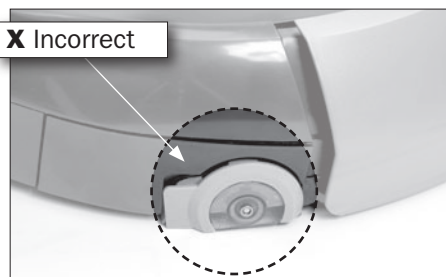
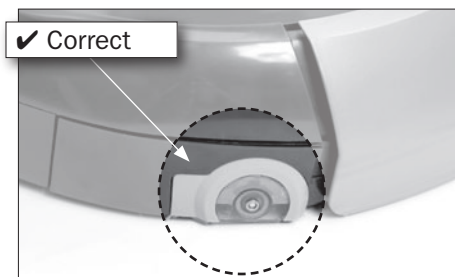

**Remember to Re-install Filter**

Be sure to re-install the filter after you remove and rinse it. Make sure it is properly seated; never force the filter into place.

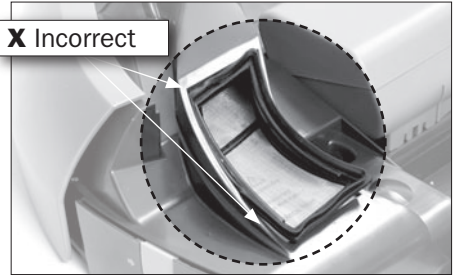
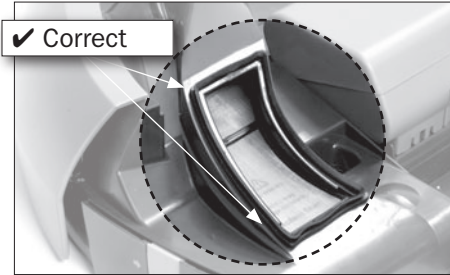

**Re-install the Vacuum Port**

Always re-install the vacuum port, and ensure that it is properly seated. Do not force the vacuum port into place.

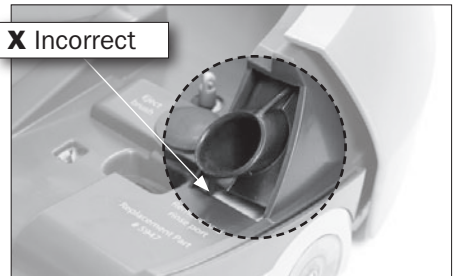
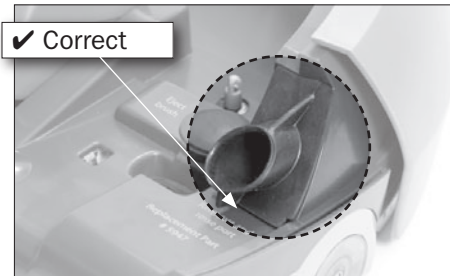

# Troubleshooting

## Warning Lights

Scooba has several warning lights that tell you if the robot needs assistance.

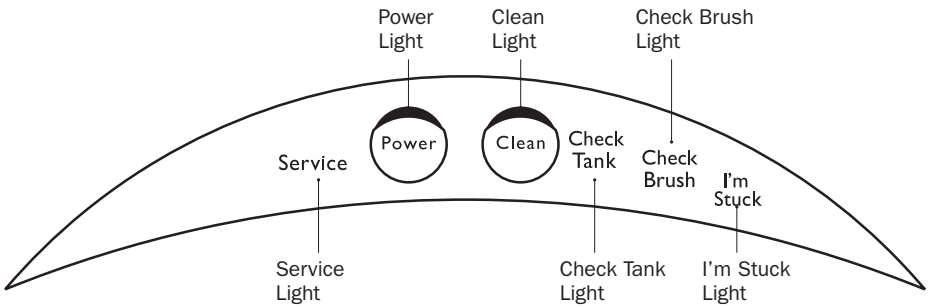

Warning Light	Possible Cause	What To Do
Check Brush Light	The brush is jammed	Remove and clean Scooba's brush and cleaning head. With cleaning head and tanks removed, turn Scooba over, inspect and clean the cleaning head area.
	The cleaning head is improperly installed	Remove and replace Scooba's cleaning head. (page 18)
	The filter is missing	Remove, rinse and replace Scooba's filter. Ensure filter is installed properly. (page 17)
Check Tank Light	The tank not is in the robot	Place the tank in the Robot and make sure the tank latch is securely closed.
	The cleaning cycle is complete	Empty the Dirty and Clean tanks. (see page 23 for additional troubleshooting)
	The pump needs to be primed	Prime Scooba's pump with the included suction bulb. (see page 24 for details)
Power Light (Red)	Battery is discharged	Recharge Scooba's battery. (page 11)

## I'm Stuck Light

When Scooba is stuck, the robot will tell you the cause of the problem by saying “uh-oh” and a number of beeps. Count the beeps after the “uh-oh” and refer to the table below to determine why Scooba is stuck. Usually, when the I'm Stuck light comes on, you need to re-start Scooba in another location.

Warning Light	Possible Cause	What To Do
I'm Stuck Light	One of Scooba's wheels is off the floor (1 beep)	Inspect Scooba's wheels. Push each wheel up and down, place the robot back on the floor and press Clean.
	The front wheel is stuck (2 beeps)	Ensure that the front wheel can spin freely. Lightly push the wheel up and down. The front wheel can easily be removed, cleaned, and replaced.
	Bumper problem (3 beeps)	Tap the bumper to ensure that it moves in and out. Visually inspect the bumper edges for debris.
	Scooba's cliff sensors are dirty or malfunctioning (4 beeps)	Clean cliff sensors with a cotton swab (see page 6 for sensor location). The cliff sensors are located in the bumper and are accessed by turning Scooba over.
	Left or right wheel malfunction (5 beeps)	Inspect Scooba's drive wheels. Spin the wheels by hand and confirm that they offer some resistance. If it does not, or if it's stuck and you can't dislodge the obstruction, contact iRobot customer care.

## Service Codes

Scooba will tell you something is wrong by turning on the Service light and playing a 4-tone alarm followed by a number of beeps.

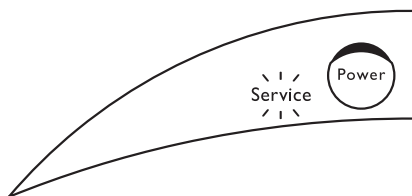

Refer to the table below to resolve

Scooba's problem. If the problem persists, visit [www.irobot.com/support](http://www.irobot.com/support).

Number of Beeps After Alarm	Likely Cause	What To Do
1	Pump malfunction	Contact iRobot customer care.
2	Vacuum malfunction	Contact iRobot customer care.
3	Battery failure	Contact iRobot customer care.
4	Charger has failed	Contact iRobot customer care.
5	Battery is too hot	Make sure Scooba was not recently filled with hot water or charged in a hot place. Wait for Scooba and battery to cool down and try again.

## Check Tank Troubleshooting

Normally, Scooba's "Check Tank" light illuminates when Scooba's Clean tank is empty or the Dirty tank is full. If the Check Tank is lit and this is not the case, follow these steps to troubleshoot the issue.

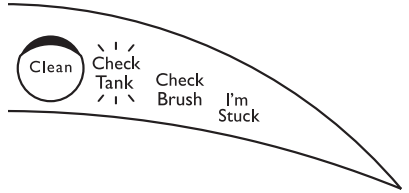

- 1 Inspect and clean Scooba's solution valve with a damp cloth.

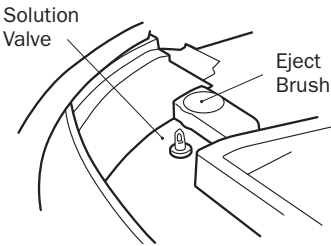

- 2 Confirm that the battery, filter, and vacuum port are properly installed, and that the tank is completely closed.

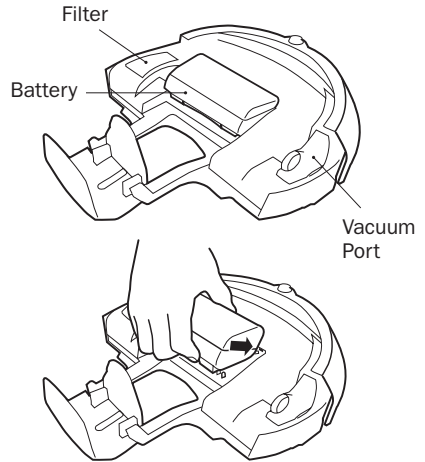

- 3 Fill Scooba's Clean tank with approximately 1 cup of cold water, shake vigorously, and empty it to remove any debris in the tank. Refill Scooba's Clean tank with water and Scooba cleaning solution or vinegar.

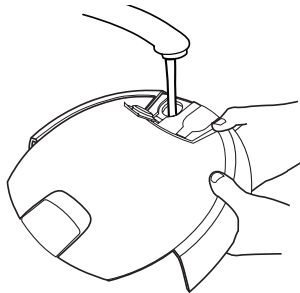

**⚠ If the battery's tabs are not inside the guide holes in the battery pocket, the tank and robot base may not be properly connected.**

- 4 Priming Scooba's Pump** Scooba's powerful cleaning system includes a pump that distributes cleaning solution from the tank onto your floor. To prime Scooba's pump, fit the end of the included suction bulb over Scooba's solution valve. Push air through Scooba's pump system 3 or 4 times.

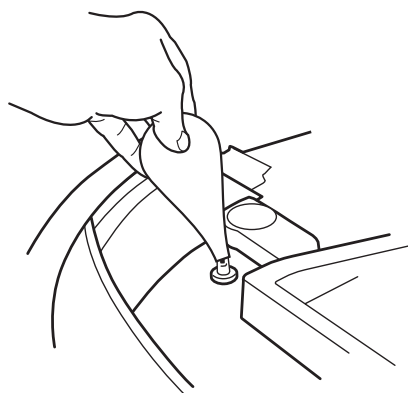
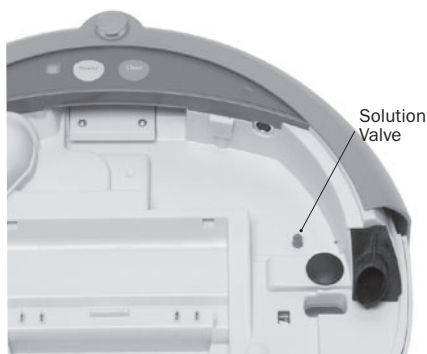

## General Troubleshooting

Problem	Likely Cause	What To Do
Scooba will not start cleaning	Power is off	Press Power, then press Clean to start Scooba.
	Battery is not charged	Charge Scooba's battery. (page 11)
	Battery is not correctly seated	Remove battery and ensure that battery tabs are placed inside Scooba's guide holes before closing Scooba's tank.
Excessive foam coming out of Scooba	There is too much cleaning solution concentrate in Clean tank	Empty and rinse the Clean tank thoroughly. When re-filling, make sure to use only 1.5 ounces of Scooba cleaning solution and to fill the Clean tank completely to the rim with water.
Cleaning head sticks out of Scooba, will not engage	Cleaning head is not closed tightly over the brush	With the tank open, slide the cleaning head out of Scooba. Squeeze the cleaning head completely closed over the brush before re-inserting it into its proper location. (page 18)



# iRobot Customer Care

If you have questions or comments about Scooba, please contact iRobot before contacting a retailer.

Please visit our web site at **www.irobot.com** for support tips, frequently asked questions, and information about accessories and other iRobot products. We would like to hear from you.

Should you still need assistance:

- Visit the iRobot support web site at **www.irobot.com/support**
- Call our customer care representatives at **877.855.8593**

## **iRobot Customer Care Hours:**

- Monday – Friday 9AM – 7PM Eastern Time
- Saturday 9AM – 6PM Eastern Time

# Important Safety Instructions

**⚠ CAUTION: DO NOT EXPOSE ELECTRONICS OF SCOOPA, ITS BATTERY OR THE CHARGER. NO USER-SERVICEABLE PARTS INSIDE. REFER SERVICING TO QUALIFIED SERVICE PERSONNEL. CHARGE USING STANDARD U.S. (120V AC) OUTLET ONLY.**

Always use care when operating Scooba. To reduce the risk of injury or damage, keep these safety precautions in mind when setting up, using and maintaining your Scooba:

## GENERAL SAFETY INSTRUCTIONS

- Read all safety and operating instructions before operating Scooba.
- Retain the safety and operating instructions for future reference.
- Observe all warnings on Scooba, battery, charger and in owner's manual.
- Follow all operating and use instructions.
- Refer all non-routine servicing to a qualified service personnel.
- Your floor may be slippery while Scooba is cleaning and after the cycle is complete. Drying times may vary.

## SCOOPA BATTERY AND CHARGING

- Operate your Scooba only from the type of power source indicated on the marking label. If you are not sure of the type of power supplied in your home, consult your local power company.
- Charge using a standard U.S. (120V AC) outlet only. Product may not be used with any type of power converter. Use of other power converters will immediately void the warranty.
- Use only the charger supplied by the manufacturer to charge this device.
- Do not use a charger with a damaged cord or plug.
- Charge indoors only.
- Never handle chargers with wet hands.
- Always disconnect Scooba from the charger before cleaning.

**SCOOBA USE RESTRICTIONS**

- Scooba is for indoor, non-commercial use only.
- Use only approved cleaning solutions. Use of other cleaning solutions will void your warranty.
- Scooba is not a toy. Do not sit or stand on this device. Small children and pets should be supervised when Scooba is cleaning.
- Clean with a damp cloth only. Do not pour or spray water onto Scooba.
- Do not use this device to pick up anything that is burning or smoking.
- Do not use this device to pick up spills of bleach, paint, or other chemicals.
- Before using this device, pick up objects such as clothing, loose papers, pull cords for blinds or curtains, power cords, and any fragile objects. If the device passes over a power cord and drags it, there is a chance an object could tumble off a table or shelf.
- If the room to be cleaned contains a balcony, a physical barrier should be used to prevent access to the balcony and ensure safe operation.
- Do not use this device to pick up flammable or combustible liquids such as gasoline.
- Always remove the battery before long-term storage or transportation.
- Operate at room temperature only. Freezing or excessive heat will damage Scooba.





**Register your  
iRobot® Scooba® today.  
SAVE 15%  
on all accessories.\***



**Scooba Cleaning Solution formulated by Clorox®**

Five 32 oz. bottles of Scooba Cleaning Solution. Fills Scooba's tank 105 times.

.....\$24<sup>99</sup>



**Scooba Replenish Kit**

Keep Scooba cleaning at peak performance levels. Includes replacement filter, 2 brushes and one cleaning head.

.....\$29<sup>99</sup>



**Scooba Virtual Wall®**

Keep Scooba cleaning where you want or away from obstacles.

.....\$29<sup>99</sup>



**Scooba Wetsuit™**

15" diameter, washable storage mat for Scooba.

.....\$12<sup>99</sup>



**Scooba Battery**

Get more continuous cleaning time from your Scooba with a second rechargeable battery.

.....\$59<sup>99</sup>



**Scooba Battery Charger**

Rapidly charges Scooba's battery outside of the robot.

.....\$39<sup>99</sup>

Get iRobot accessories at:  
**800.727.9077** or visit **store.irobot.com**

*\*See registration card for details. Pricing and availability subject to change. Shipping and handling not included.*



© 2006 iRobot Corporation, 63 South Avenue, Burlington, MA 01803. All rights reserved. iRobot, Scooba and Virtual Wall are registered trademarks of iRobot Corporation.

US Pat. Nos. 6,690,134 | 6,809,490 | 6,594,844. Other patents pending. Clorox is a registered trademark of The Clorox Company. All rights reserved. Pergo is a registered trademark of Pergo Incorporated. All rights reserved.

Download from [www.Somanuals.com](http://www.Somanuals.com). All Manuals Search And Download.

## Free Manuals Download Website

<http://myh66.com>

<http://usermanuals.us>

<http://www.somanuals.com>

<http://www.4manuals.cc>

<http://www.manual-lib.com>

<http://www.404manual.com>

<http://www.luxmanual.com>

<http://aubethermostatmanual.com>

Golf course search by state

<http://golfingnear.com>

Email search by domain

<http://emailbydomain.com>

Auto manuals search

<http://auto.somanuals.com>

TV manuals search

<http://tv.somanuals.com>