

JVC

ENGLISH

VIDEO CASSETTE RECORDER

HR-S8700EU

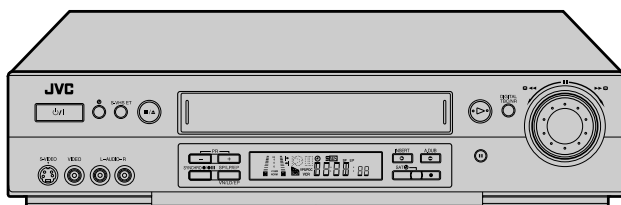

SHOWVIEW[®] DELUXE *Hi-Fi* **SVHS** 625

Super VHS ET

INSTRUCTIONS

CONTENTS

SAFETY FIRST	2
Safety Precautions	2
INDEX	4
INSTALLING YOUR NEW RECORDER	10
Basic Connections	10
S-VIDEO Connection	11
INITIAL SETTINGS	12
Auto Set Up	12
Preset Download	14
Language	16
SAT CONTROL SET	17
Satellite Receiver Control Setting	17
T-V LINK	19
T-V Link Functions	19
PLAYBACK	20
Basic Playback	20
Playback Features	21
RECORDING	24
Basic Recording	24
Recording Features	25
B.E.S.T. Picture System	29
TIMER RECORDING	30
SHOWVIEW [®] Timer Programming	30
Express Timer Programming	32
Automatic Satellite Programme Recording ...	36
REMOTE CONTROL FUNCTIONS	37
VIDEO NAVIGATION	40
Navigation	40
Edit Title	42
Find Title	46
EDITING	49
Edit From A Camcorder	49
Output/Input Set	50
Edit To Or From Another Video Recorder ...	52
Audio Dubbing	54
Insert Editing	56
Synchro Editing	58
Information On J Terminal	59
SYSTEM CONNECTIONS	60
Connecting To A Satellite Receiver	60
Connecting/Using A Decoder	62
Connecting/Using A Stereo System	63
SUBSIDIARY SETTINGS	64
Mode Set	64
Tuner Set	68
Video Channel Set	74
SHOWVIEW [®] System Setup	75
Clock Set	76
TROUBLESHOOTING	78
QUESTIONS AND ANSWERS	81
SPECIFICATIONS	82
LIST OF TERMS	83

LPT0327-001A

EN

Safety Precautions

The rating plate and the safety caution are on the rear of the unit.

WARNING: DANGEROUS VOLTAGE INSIDE

WARNING: TO PREVENT FIRE OR SHOCK HAZARD, DO NOT EXPOSE THIS UNIT TO RAIN OR MOISTURE.

CAUTION

- When you are not using the recorder for a long period of time, it is recommended that you disconnect the power cord from the mains outlet.
- Dangerous voltage inside. Refer internal servicing to qualified service personnel. To prevent electric shock or fire hazard, remove the power cord from the mains outlet prior to connecting or disconnecting any signal lead or aerial.

WARNING

There are two different types of SECAM colour systems: SECAM-L, used in FRANCE (also called SECAM-West), and SECAM-B, used in Eastern European countries (also called SECAM-East).

1. This recorder can also receive SECAM-B colour television signals for recording and playback.
2. Recordings made of SECAM-B television signals produce monochrome pictures if played back on a video recorder of SECAM-L standard, or do not produce normal colour pictures if played back on a PAL video recorder with SECAM-B system incorporated (even if the TV set is SECAM-compatible).
3. SECAM-L prerecorded cassettes or recordings made with a SECAM-L video recorder produce monochrome pictures when played back with this recorder.
4. This recorder cannot be used for the SECAM-L standard. Use a SECAM-L recorder to record SECAM-L signals.

IMPORTANT

- Please read the various precautions on pages 2 and 3 before installing or operating the recorder.
- It should be noted that it may be unlawful to re-record pre-recorded tapes, records, or discs without the consent of the owner of copyright in the sound or video recording, broadcast or cable programme and in any literary, dramatic, musical, or artistic work embodied therein.



- Cassettes marked "S-VHS" and "VHS" can be used with this video cassette recorder. However, S-VHS recordings are possible only with cassettes marked "S-VHS".
By using the S-VHS ET function, it is possible to record and play back with S-VHS picture quality on VHS cassettes with this recorder.
- SHOWVIEW is a registered trademark of Gemstar Development Corporation. The SHOWVIEW system is manufactured under licence from Gemstar Development Corporation.

For Italy:

"It is declared that this product, brand JVC, conforms to the Ministry Decree n. 548 of 28 Aug.'95 published in the Official Gazette of the Italian Republic n. 301 of 28 Dec.'95"

The STANDBY/ON ϕ/I button does not completely shut off mains power from the unit, but switches operating current on and off. " ϕ " shows electrical power standby and "I" shows ON.

Video tapes recorded with this video recorder in the LP/EP (Long Play/Extended Play) mode cannot be played back on a single-speed video recorder.

Failure to heed the following precautions may result in damage to the recorder, remote control or video cassette.

1. DO NOT place the recorder . . .

- ...in an environment prone to extreme temperatures or humidity.
- ...in direct sunlight.
- ...in a dusty environment.
- ...in an environment where strong magnetic fields are generated.
- ...on a surface that is unstable or subject to vibration.

2. DO NOT block the recorder's ventilation openings.**3. DO NOT place heavy objects on the recorder or remote control.****4. DO NOT place anything which might spill on top of the recorder or remote control.****5. AVOID violent shocks to the recorder during transport.****MOISTURE CONDENSATION**

Moisture in the air will condense on the recorder when you move it from a cold place to a warm place, or under extremely humid conditions—just as water droplets form in the surface of a glass filled with cold liquid. Moisture condensation on the head drum will cause damage to the tape. In conditions where condensation may occur, keep the recorder turned on for a few hours to let the moisture dry.

FRONT VIEW

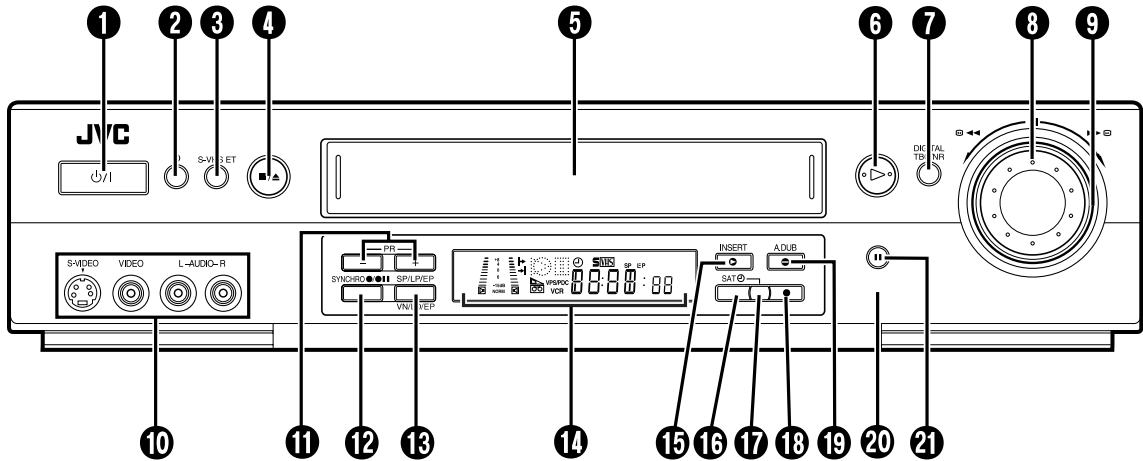

- ❶ STANDBY/ON ψ/I Button \hookrightarrow pg. 12
- ❷ Timer \odot Button \hookrightarrow pg. 31, 33
- ❸ S-VHS ET Button \hookrightarrow pg. 27
- ❹ Stop/Eject $\blacksquare/\blacktriangle$ Button \hookrightarrow pg. 20, 24
- ❺ Cassette Loading Slot
- ❻ Play \blacktriangleright Button \hookrightarrow pg. 20
- ❼ DIGITAL TBC/NR Button \hookrightarrow pg. 23
- ❽ JOG Dial \hookrightarrow pg. 21
- ❾ SHUTTLE Ring \hookrightarrow pg. 20
- ❿ S-VIDEO/VIDEO/AUDIO Input Connectors \hookrightarrow pg. 49, 54, 56
- ⓫ PR +/- Buttons \hookrightarrow pg. 24
- ⓬ SYNCHRO $\bullet/\bullet\parallel$ Button \hookrightarrow pg. 58
- ⓭ SP/LP/EP Button \hookrightarrow pg. 24
- ⓮ Front Display Panel \hookrightarrow pg. 6
- ⓯ INSERT Button \hookrightarrow pg. 57
- ⓰ SAT \odot Button \hookrightarrow pg. 36
- ⓱ SAT \odot Indicator \hookrightarrow pg. 36
- ⓲ Record \bullet Button \hookrightarrow pg. 24
- ⓳ Audio Dubbing (A.DUB) Button \hookrightarrow pg. 55
- ⓴ Infrared Beam Receiving Window
- ⓵ Pause \parallel Button \hookrightarrow pg. 21

REAR VIEW

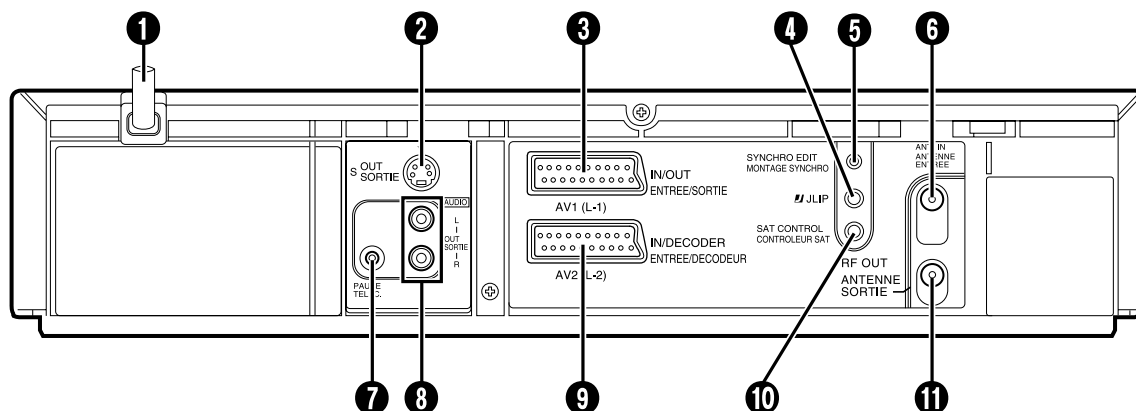

- 1** Mains Power Cord ☞ pg. 10
- 2** S OUT Connector ☞ pg. 11
- 3** AV1 (L-1) IN/OUT Connector ☞ pg. 10, 52, 60, 61, 62
- 4** J Terminal [JLIP (Joint Level Interface Protocol) Connector] ☞ pg. 59
- 5** SYNCHRO EDIT Connector ☞ pg. 58
- 6** ANT. IN Connector ☞ pg. 10
- 7** Remote PAUSE Connector ☞ pg. 49
- 8** AUDIO OUT (L/R) Connectors ☞ pg. 63
- 9** AV2 (L-2) IN/DECODER Connector ☞ pg. 17, 52, 60, 61, 62
- 10** SAT CONTROL Connector ☞ pg. 17
- 11** RF OUT Connector ☞ pg. 10

FRONT DISPLAY PANEL

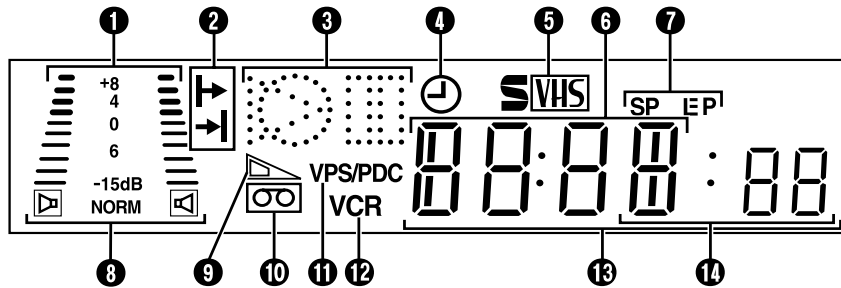

- ❶ B.E.S.T. Picture System Display ☞ pg. 29
Audio Level Indicator ☞ pg. 27
- ❷ Programme Time Indicators ☞ pg. 32
- ❸ Symbolic Mode Indicators

PLAY: FF/REW VARIABLE SEARCH:	STILL: SLOW:	
	RECORD:	
	RECORD PAUSE:	
AUDIO DUBBING:		
AUDIO DUBBING PAUSE:		
INSERT:		
INSERT PAUSE:		
AV INSERT:		
AV INSERT PAUSE:		

- ❹ "Timer" Indicator ☞ pg. 31, 33
- ❺ S-VHS Indicator ☞ pg. 27, 67
- ❻ Channel/Clock Display ☞ pg. 15
- ❼ Tape Speed Indicators ☞ pg. 24
- ❽ Audio Mode Indicator ☞ pg. 23
- ❾ Tape Remaining Time Indicator ☞ pg. 25
- ❿ "Cassette Loaded" Mark
- ⓫ VPS/PDC Indicator ☞ pg. 31, 33
- ⓬ VCR Indicator ☞ pg. 25
- ⓭ Counter/Remain Display
(The counter can display up to +/- "19:59:59". If the playback or recording time exceeds this limit, the display starts to count from "0:00:00".)
- ⓮ Mode Display (L-1, L-2, F-1, S-1 or SAT*)

* When "L-2 SELECT" is set to "SAT" (☞ pg. 51), "SAT" appears instead of "L-2".

ON-SCREEN DISPLAY

When "O.S.D." is set to "ON" (☞ pg. 65), various operational indicators appear on the TV screen.

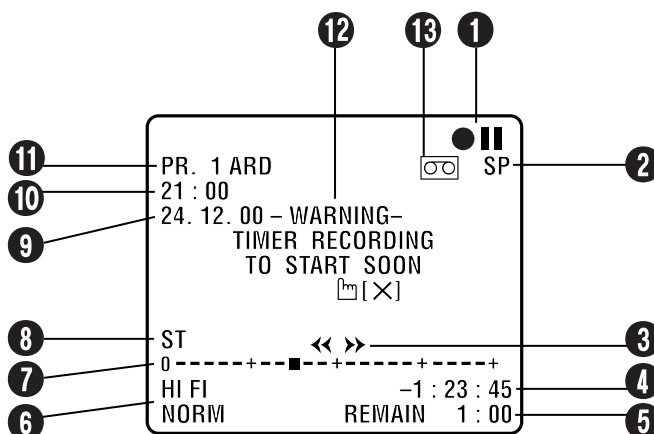

1 Operation Mode Indicators

2 Tape Speed SP/LP/EP

3 Tape Direction

4 Counter Display

5 Tape Remaining Time Indicator ☞ pg. 25

6 Audio Mode Display ☞ pg. 23

7 Tape Position Indicator

The tape position indicator appears on the TV screen when you press <<< or >>> from the Stop mode or perform an Index Search (☞ pg. 22). The position of "█" in relation to "0" (beginning) or "+" (end) shows you where you are on the tape.

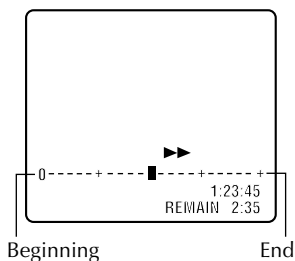

NOTE:

Depending on the type of tape being used, the tape position indicator may not appear correctly.

8 Type of Broadcast ☞ pg. 28

9 Current Day/Month/Year

10 Clock Display

11 Channel Position Number and Station Name/ Auxiliary Input Indicator (L-1, L-2, F-1, S-1 or SAT*)

* When "L-2 SELECT" is set to "SAT" (☞ pg. 51), "SAT" appears instead of "L-2".

12 Timer Warning Display

A warning appears on the TV screen to tell you that the timer-recording is to start in 5 minutes if you're not in the Timer mode at that time. The warning blinks for the entire 5 minutes leading up to the start of timer recording. To clear the display, press X on the remote control.

13 "Cassette Loaded" Mark

REMOTE CONTROL

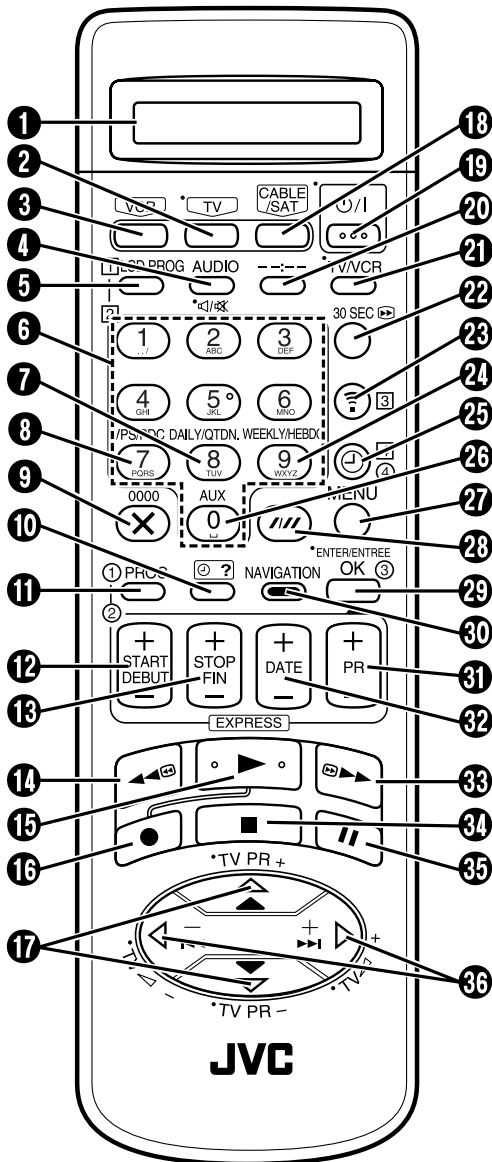

- ❶ LCD Panel ☞ pg. 9, 30
- ❷ TV Button ☞ pg. 38
- ❸ VCR Button ☞ pg. 37
- ❹ AUDIO Button ☞ pg. 23
- ⏻ (TV Muting) Button ☞ pg. 38
- ❺ LCD PROG Button ☞ pg. 30
- ❻ Number Keys ☞ pg. 24, 30
- ❼ DAILY Button ☞ pg. 31, 33
- ❽ VPS/PDC Button ☞ pg. 31, 33
- ❾ Counter Reset 0000 Button ☞ pg. 25
- ✕ Cancel X Button ☞ pg. 34
- ⊙ ? Programme Check ⊙ ? Button ☞ pg. 34
- Ⓜ PROG Button ☞ pg. 30
- ⊕ START +/- Button ☞ pg. 32
- ⊖ STOP +/- Button ☞ pg. 32
- ⏮ Rewind << Button ☞ pg. 20, 21
- ⏭ Play >> Button ☞ pg. 20
- Record ● Button ☞ pg. 24
- △ ▽ TV PR +/- Button ☞ pg. 38
- CABLE/SAT Button ☞ pg. 39
- ⏻ STANDBY/ON ⏻ Button ☞ pg. 12
- :-- Display --:-- Button ☞ pg. 25
- TV/VCR Button ☞ pg. 25
- 30 SEC Button ☞ pg. 22
- ̳ Transmit ̳ Button ☞ pg. 30
- WEEKLY Button ☞ pg. 31, 33
- ⌚ Timer ⌚ Button ☞ pg. 31, 33
- AUX Button ☞ pg. 49
- MENU Button ☞ pg. 16
- /// Auto Tracking /// Button ☞ pg. 23
- SP/LP/EP Button ☞ pg. 24
- OK Button ☞ pg. 13
- NAVIGATION Button ☞ pg. 40
- PR +/- Button ☞ pg. 24
- DATE +/- Button ☞ pg. 32
- >>> Fast Forward >>> Button ☞ pg. 20, 21
- Stop ■ Button ☞ pg. 20, 24
- || Pause || Button ☞ pg. 21
- <> <> Button ☞ pg. 21, 22
- ◁ TV ◁ +/- Button ☞ pg. 38

Buttons with a small dot on the left side of the name can also be used to operate your TV. (☞ pg. 38)

How To Use

The remote control can operate most of your video recorder's functions, as well as basic functions of TV sets and satellite receivers of JVC and other brands. (☞ pg. 38, 39)

- Point the remote control toward the receiving window.
- The maximum operating distance of the remote control is about 8 m.

NOTES:

- When inserting the batteries, be sure to insert in the correct directions as indicated under the battery cover.
- If the remote control doesn't work properly, remove its batteries, wait a short time, replace the batteries and then try again.

Remote Control LCD

The remote control can operate not only the video recorder but also some of your TV and satellite receiver's functions. The LCD indicates which of these (VIDEO, TV or CABLE/SAT) the remote control can currently operate. When you first purchase the remote control, or after you have just replaced the batteries, VIDEO A (A code) is selected.

- 1 To operate your video recorder, first press the **VCR** button to set the remote control to the Video mode. To switch the remote control's A/B code, refer to page 37.

 A rectangular LCD display showing the text "VIDEO A" in a digital font. The "V" is slightly larger and positioned to the left of "IDEO".

- 2 To operate your TV, first press the **TV** button to set the remote control to the TV mode. (☞ pg. 38)

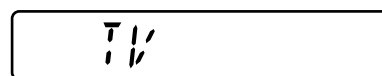
 A rectangular LCD display showing the text "TV" in a digital font.

- 3 To operate your satellite receiver, first press the **CABLE/SAT** button to set the remote control to the satellite receiver mode. (☞ pg. 39)

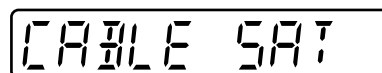

 A rectangular LCD display showing the text "CABLE SAT" in a digital font.

NOTES:

Even if "TV" is displayed on the LCD, the following operations can be performed without switching the mode.

- Basic operations for the recorder
After an operation is completed, "TV" reappears on the LCD.
- Express timer programming and SHOWVIEW timer programming operations
To perform a TV operation again, switch to TV mode first.
- Accessing main menu
To perform a TV operation again, switch to TV mode first.

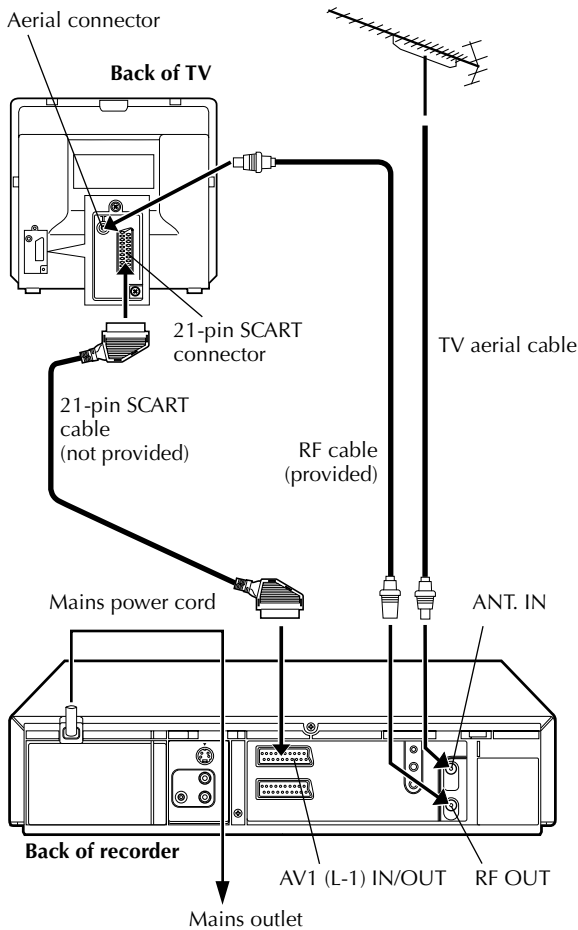
Basic Connections



Make AV connection if your TV has a 21-pin AV input connector (SCART) in order to reduce the possibility of interference. With AV connection, you can enjoy stereo playback of video tapes if you are using a stereo TV.

NOTES:

- The AV1 (L-1) IN/OUT connector accepts and delivers either a composite signal (regular video signal) or a Y/C signal (a signal in which the luminance and chrominance signals are separated). If your TV's 21-pin AV input connector (SCART) is compatible with the Y/C signal, set "L-1 OUTPUT" to "S-VIDEO" after the connection and the initial settings are completed (☞ pg. 50). You can obtain high-quality S-VHS pictures. (For connection, be sure to use a 21-pin SCART cable that is compatible with the Y/C signal.)
- Set your TV to the VIDEO (or AV), Y/C, or RGB mode according to the type of your TV's SCART connector.
- For switching the TV's mode, refer to the instruction manual of your television.
- To obtain high-quality S-VHS pictures, you can also use the S-VIDEO connection described on page 11.

It's essential that your video recorder be properly connected.

THESE STEPS MUST BE COMPLETED BEFORE ANY VIDEO OPERATION CAN BE PERFORMED.

1 Check the contents.

Make sure the package contains all of the accessories listed in "SPECIFICATIONS" on page 82.

2 Situate the recorder.

Place the recorder on a stable, horizontal surface.

3 Connect the recorder to TV.

The connection method you use depends on the type of TV you have.

RF Connection

■ To connect to a TV with NO AV input connectors . . .

- 1 Disconnect the TV aerial cable from the TV.
- 2 Connect the TV aerial cable to the ANT. IN connector on the rear panel of the recorder.
- 3 Connect the provided RF cable between the RF OUT connector on the rear panel of the recorder and the TV's aerial connector.

AV Connection

■ To connect to a TV with AV input connectors . . .

- 1 Connect the aerial, recorder and TV as per "RF Connection".
- 2 Connect an optional 21-pin SCART cable between the AV1 (L-1) IN/OUT connector on the rear panel of the recorder and the TV's 21-pin SCART connector.

4 Connect the recorder to mains.

Plug the end of the mains power cord into a mains outlet.

After the connection is completed, perform "Auto Set Up" on page 12.

S-VIDEO Connection

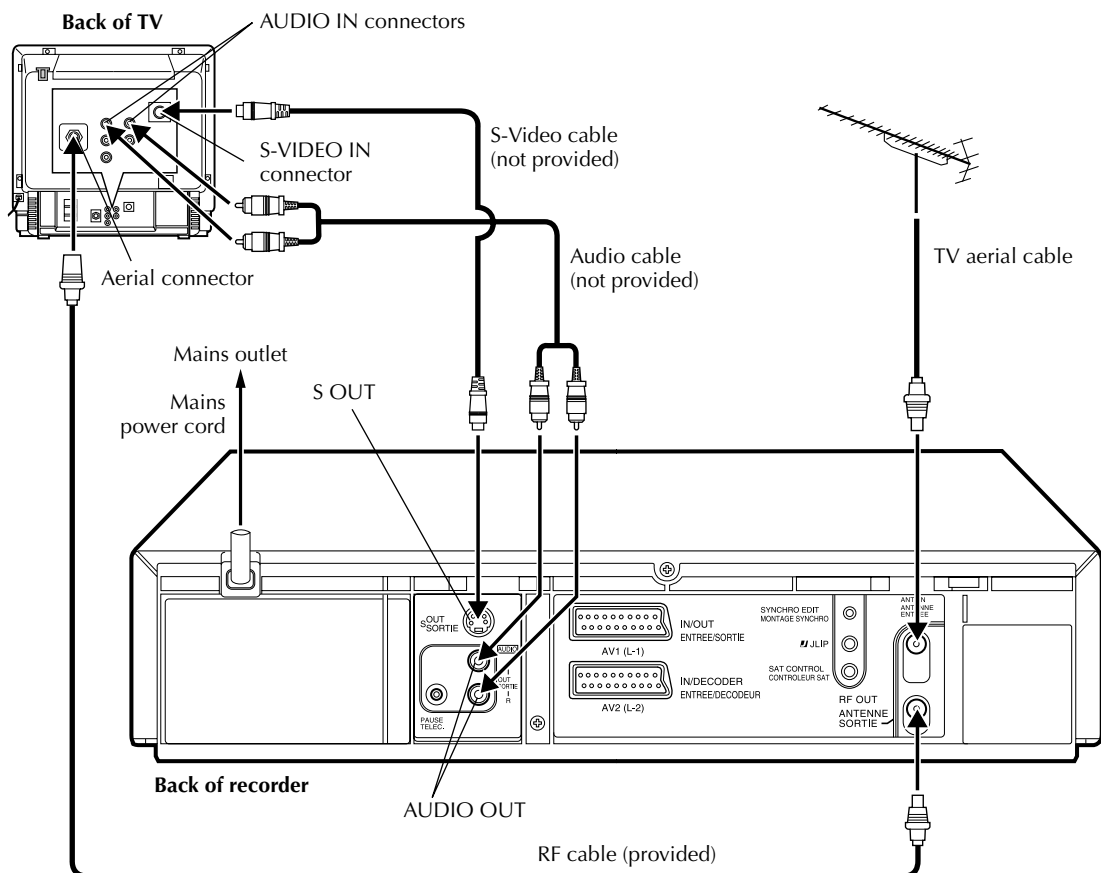

■ To connect to a TV with S-VIDEO/AUDIO IN connectors . . .

1 Connect the recorder to TV.

- 1 Connect the aerial, recorder and TV as per "RF Connection" (☞ pg. 10).
- 2 Connect the recorder's S OUT connector to the TV's S-VIDEO IN connector.
- 3 Connect the recorder's AUDIO OUT connectors to the TV's AUDIO IN connectors.

2 Connect the recorder to mains.

Plug the end of the mains power cord into a mains outlet.

NOTES:

- You can obtain high-quality S-VHS pictures.
- With S-VIDEO connection, you cannot use the Preset Download function (☞ pg. 14).
- If your TV is not stereo-capable, use the recorder's AUDIO OUT connectors to connect to an audio amplifier for Hi-Fi stereo sound reproduction. (☞ pg. 63)
- To operate the recorder with your TV using the S-VIDEO connection, set your TV to its AV mode.
- For switching the TV's mode, refer to the instruction manual of your television.

After the connection is completed, perform "Auto Set Up" on page 12.

Auto Set Up

Auto Channel Set/Auto Clock Set/ Auto Guide Program Number Set

After the $\psi/1$ button on the recorder or remote control is pressed for the first time to power on the recorder, by simply selecting your country*, the Auto Set Up function sets the tuner channels, clock** and Guide Program numbers automatically.

* If you live in Belgium (BELGIUM) or Switzerland (SUISSE), you also need to select your language.

** If you live in Hungary (MAGYARORSZÁG), Czech Republic (ČESKÁ REPUBLIKA), Poland (POLSKA), Russia (РОССИЯ) or other countries in Eastern Europe (OTHER EASTERN EUROPE), set the clock manually.

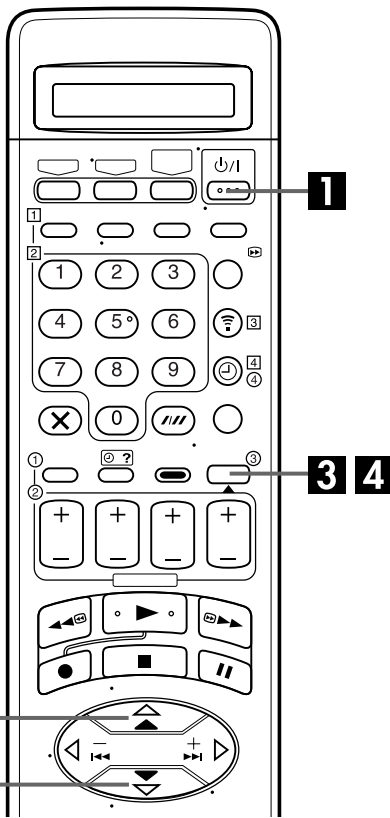

Before starting, make sure of the following:

- The TV aerial cable should be connected to the recorder.
- The recorder's mains power cord should be connected to a mains outlet.
- If you want to use the on-screen display, the TV should be set to its AV mode (with AV or S-VIDEO connection pg. 10, 11) or UHF channel 36 (with RF connection pg. 10).

1 Turn on the recorder.

Press $\psi/1$ on the recorder or remote control. The Country Set display appears on the front display panel and/or on the TV screen.

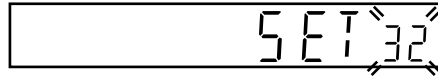

NOTE:

If you have connected your TV to the recorder with RF connection and the on-screen display appearing on UHF channel 36 looks distorted, perform "Video Channel Set" on page 74.



2 Select your country.

On the front display panel

Press Δ/∇ to select your international telephone country code of your country referring to the chart in the left column.

(Example) DEUTSCHLAND (49) is selected.



On the on-screen display

Press Δ/∇ to move the highlight bar (pointer) to your country's name.



NOTES:

- If you have selected BELGIUM (32) or SUISSE (41), go to step 3.
- If you have selected MAGYARORSZÁG (36), ČESKÁ REPUBLIKA (42), POLSKA (48), РОССИЯ (07) or OTHER EASTERN EUROPE (EE), press **OK**. The Clock Set screen appears. Set the clock manually (pg. 76), then go to step 4.
- If you have selected any other country name (code), press **OK** and go to step 4.

International Telephone Country Code

BELGIUM	: 32	ÖSTERREICH	: 43
ČESKÁ REPUBLIKA	: 42	POLSKA	: 48
DANMARK	: 45	PORTUGAL	: 351
DEUTSCHLAND	: 49	SUISSE	: 41
ESPAÑA	: 34	SUOMI	: 358
GREECE	: 30	SVERIGE	: 46
ITALIA	: 39	РОССИЯ	: 07
MAGYARORSZÁG	: 36	OTHER WESTERN EUROPE	: --
NEDERLAND	: 31	OTHER EASTERN EUROPE	: EE
NORGE	: 47		

3 Select the language.

Press **OK**. The Language Set display appears on the front display panel and/or on the TV screen.

On the front display panel

Press $\Delta \nabla$ to select your language code.

Language Code			
ENGLISH	: 01	NORSK	: 08
DEUTSCH	: 02	SUOMI	: 09
FRANCAIS	: 03	DANSK	: 10
ITALIANO	: 04	POLSKI	: 11
CASTELLANO	: 05	ČEŠTINA	: 12
NEDERLANDS	: 06	MAGYAR	: 13
SVENSKA	: 07	ЉЗЫК	: 14

(Example) DEUTSCH (02) is selected for SUISSE (41).

International telephone
country code Language code

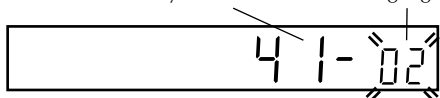

On the on-screen display

Press $\Delta \nabla$ to move the highlight bar (pointer) to the language of your choice.



4 Perform Auto Set Up.

Press **OK**. The AUTO SET/T-V LINK display appears on the front display panel and/or on the TV screen.

On the front display panel

Press $\Delta \nabla$ to select "Auto" and press **OK** or \triangleright .

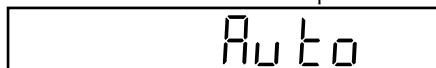

On the on-screen display

Press $\Delta \nabla$ to move the highlight bar (pointer) to "AUTO SET" and press **OK** or \triangleright .



"Auto" blinks on the front display panel; do NOT press any button on the recorder or remote control until the front display panel shows clock time, "(CH) 1" or "--:--" as illustrated on page 15.

- If you are using the on-screen display, the AUTO SET screen will appear. As Auto Set Up progresses, the "█" mark on the TV screen moves from left to right. When the Auto Set Up is completed, "SCAN COMPLETED" appears for about 5 seconds, then the normal screen appears.

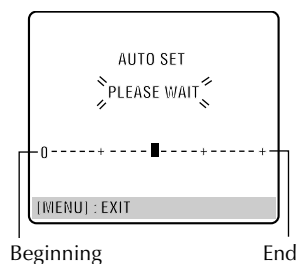

- If you have connected the recorder to your TV via the AV connection (☞ pg. 10), the recorder will automatically perform Preset Download (☞ pg. 14) instead of the Auto Set Up.

ATTENTION

Once you have performed Auto Set Up, even if the recorder's memory backup has expired, all the stored stations and their Guide Program numbers remain in the recorder's memory and the recorder will not perform Auto Set Up again. You only need to set the clock. (☞ pg. 76)

If you have moved to a different area, perform each setting as required.

- Video channel setting (for RF connection users) ☞ pg. 74
- Tuner setting ☞ pg. 68
- Clock setting ☞ pg. 76

If a new station starts broadcasting in your area, perform tuner setting (☞ pg. 68) and, if necessary, video channel setting (☞ pg. 74).

NOTES:

- In the area where no TV station transmits a PDC (Programme Delivery Control) signal, the recorder can perform neither Auto Clock Set nor Auto Guide Program Number Set.
- If there is a power cut, or if you press \cup / \cap or **MENU** while Auto Set Up is in progress, Auto Set Up will be interrupted; be sure to turn off the recorder power once and try again from step 1.
- Auto Clock Set may not function properly depending on the reception condition.
- If no sound accompanies the picture or the audio sounds unnatural on some channels that have been stored by Auto Set Up, the TV system setting for those channels may be incorrect. Select the appropriate TV system for those channels (☞ pg. 71, "INFORMATION").

Preset Download

Auto Channel Set by Downloading from TV/Auto Clock Set/Auto Guide Program Number Set

ATTENTION

You can use this function only with a TV offering T-V Link, etc.* Be sure to use a fully-wired 21-pin SCART cable.

* Compatible with TVs offering T-V Link, EasyLink, Megalogic, SMARTLINK, Q-Link, DATA LOGIC or NexTVView Link via fully-wired 21-pin SCART cable. The degree of compatibility and available functions may differ by system.

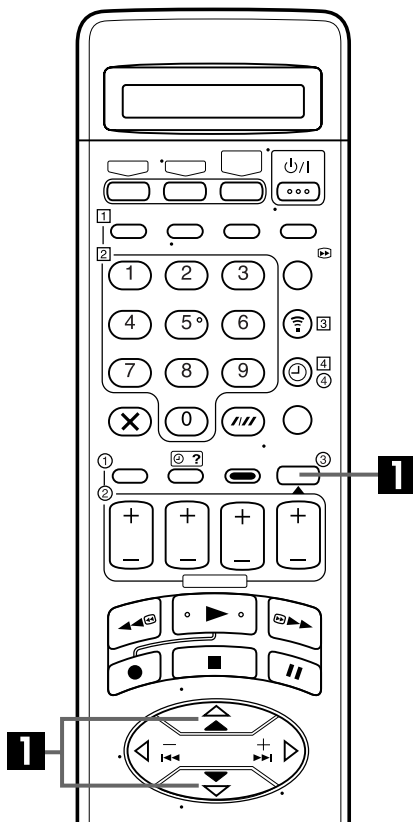

NOTES:

- For details, refer to the instruction manual of your TV.
- In the area where no TV station transmits a PDC (Programme Delivery Control) signal, the recorder can perform neither Auto Clock Set nor Auto Guide Program Number Set.
- If there is a power cut, or if you press ψ/I or **MENU** while downloading or set up is in progress, it will be interrupted; be sure to turn off the recorder power once and try again from the beginning.
- Auto Clock Set may not function properly depending on the reception condition.
- On this recorder, the characters available for station names (ID) are A-Z, 0-9, -, *, + and _ (space). Some names of downloaded stations may differ from those of your TV (pg. 72).

If you have connected the recorder to your TV via the AV connection (pg. 10), the recorder will automatically perform Preset Download instead of the Auto Set Up in step 4 on page 13. After downloading, the recorder sets the clock and Guide Program numbers automatically.

Perform steps 1 to 3 of "Auto Set Up" on page 12 before continuing.

1 Perform Preset Download.

Press **OK**. The AUTO SET/T-V LINK display appears on the front display panel and/or on the TV screen.

On the front display panel

Press ∇ to select "CH --" and press **OK** or \triangleright .

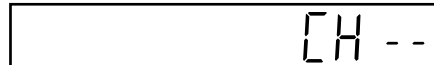

On the on-screen display

Press ∇ to move the highlight bar (pointer) to "T-V LINK" and press **OK** or \triangleright .

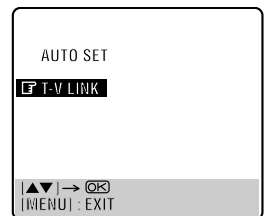

Preset positions on the front display panel increase from "CH1"; do NOT press any button on the recorder or remote control until the front display panel shows clock time, "(CH) 1" or "--:--" as illustrated on page 15.

- If you are using the on-screen display, the T-V LINK screen will appear. Then the GUIDE PROG SET screen will appear during Guide Program Number Set. When Preset Download is completed, "COMPLETED" appears for about 5 seconds, then the normal screen appears.
- If you press any button on the recorder or remote control while downloading is in progress, it will be interrupted.

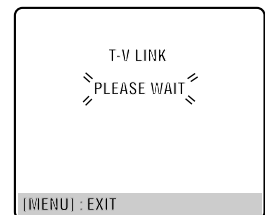

2 Set the video channel.

Set the video channel to off manually. (pg. 74)

Results of Auto Set Up/Presets Download appear on the front display panel

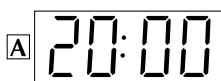

If both Auto Channel Set and Auto Clock Set have been performed successfully, the correct current time is displayed.

Turn on the TV and select its video channel or AV mode, then make sure that all necessary stations have been stored in the recorder's memory by using the **PR** button(s).

- If station names (ID – pg. 73) have also been stored in the recorder's memory, the station name will be displayed at the top left corner of the TV screen for about 5 seconds when the recorder is tuned to a different station.
- If you want to set the tuner manually such as to add or skip channels, to change channel positions, or to set or change station names, see pages 70 – 73.



If Auto Channel Set has succeeded but Auto Clock Set has not, "1" (channel position) is displayed.

- 1 Turn on the TV and select its video channel or AV mode, then make sure that all necessary stations have been stored in the recorder's memory by using the **PR** button(s).
 - If station names (ID – pg. 73) have also been stored in the recorder's memory, the station name will be displayed at the top left corner of the TV screen for about 5 seconds when the recorder is tuned to a different station.
 - If you want to set the tuner manually such as to add or skip channels, to change channel positions, or to set or change station names, see pages 70 – 73.
- 2 Perform "Clock Set" on page 76.

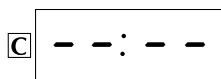

If both Auto Channel Set and Auto Clock Set have failed, "--:--" is displayed.

Make sure the cables are connected properly and turn off the recorder's power once, then turn the recorder's power back on again.

The Country Set display appears on the front display panel and/or on the TV screen; perform "Auto Set Up" on page 12 or "Presets Download" on page 14 again.

IMPORTANT

- To check if the Guide Program numbers have been set correctly, perform the SHOWVIEW Timer Programming (pg. 30).
- In certain reception conditions, station names may not be stored correctly, and auto Guide Program Number Set may not work properly. If the Guide Program numbers are not set properly when you timer-record a TV programme using the SHOWVIEW system, the recorder will record a TV programme of a different station. When programming the timer using the SHOWVIEW system, be sure to check the desired channel is selected correctly (pg. 30, "SHOWVIEW" Timer Programming).
- Your video recorder memorizes all detected stations even if reception of some of them is poor. You can delete those stations with an unacceptable picture (pg. 71, "Delete A Channel").

INFORMATION

Language for the on-screen display

Auto Set Up also selects the language automatically for the on-screen display depending on the Country setting you have made in step 2 on page 12 (unless you have selected BELGIUM or SUISSE), as shown below.

SUOMI	→ SUOMI	DANMARK	→ DANSK	NEDERLAND	→ NEDERLANDS
PORTUGAL	→ ENGLISH	ÖSTERREICH	→ DEUTSCH	GREECE	→ ENGLISH
DEUTSCHLAND	→ DEUTSCH	ČESKÁ REPUBLIKA	→ ČEŠTINA	РОССИЯ	→ ЯЗЫК
POLSKA	→ POLSKI	ITALIA	→ ITALIANO	OTHER WESTERN EUROPE	→ ENGLISH
NORGE	→ NORSK	MAGYARORSZÁG	→ MAGYAR	OTHER EASTERN EUROPE	→ ENGLISH
SVERIGE	→ SVENSKA	ESPAÑA	→ CASTELLANO		

If you want to change the language setting manually, see "Language" on page 16.

Just Clock

Your recorder is equipped with the Just Clock function which provides accurate time keeping through automatic adjustments at regular intervals, by reading data from a PDC signal. If you want to take advantage of this function, simply set it to "ON" (pg. 76, "Just Clock").

Language

Turn on the TV and select the video channel (or AV mode).

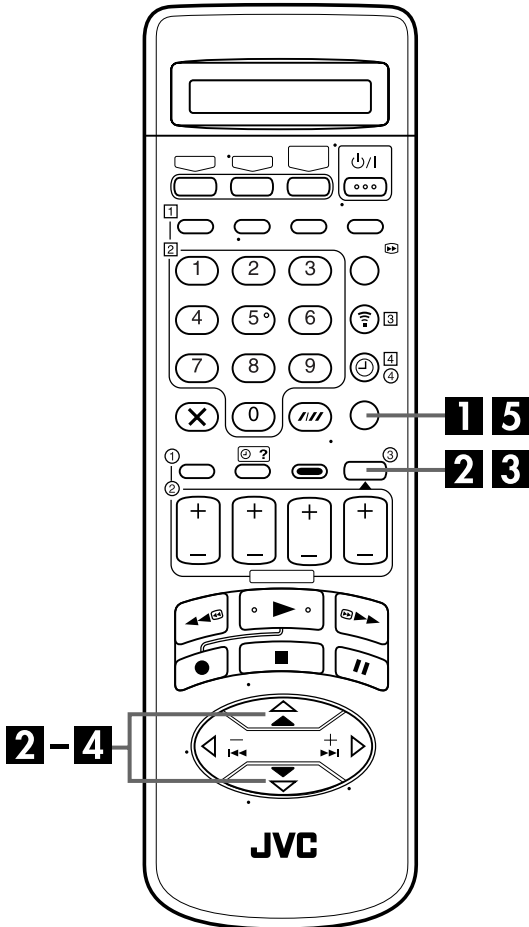

This recorder offers you the choice to view on-screen messages in 14 different languages. Though Auto Set Up selects the language automatically (pg. 15), you can change the language setting manually as required.

1 Access the Main Menu screen.

Press MENU.

2 Access the Country Set screen.

Press Δ / ∇ to move the highlight bar (pointer) to "AUTO CH SET", then press OK or \triangleright .

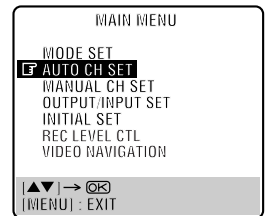

3 Select your country.

Press Δ / ∇ to move the highlight bar (pointer) to your country's name, then press OK or \triangleright .

4 Select the language.

Press Δ / ∇ to move the highlight bar (pointer) to the language of your choice.

- You do not have to press OK; pressing OK enters AUTO SET/T-V LINK screen.



5 Return to the normal screen.

Press MENU.

Satellite Receiver Control Setting

The following procedure is required if you receive satellite channels through a satellite receiver. Approximately 20 seconds before the SHOWVIEW timer programming (⏏ pg. 30) or Express timer programming (⏏ pg. 32) starts, the recorder sets its input mode to "L-2" and automatically switches the satellite receiver's channels using the provided Satellite Controller.

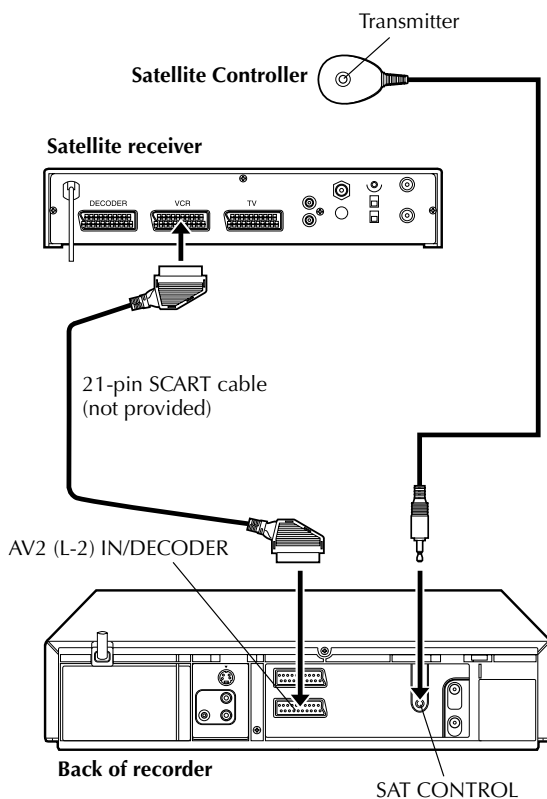
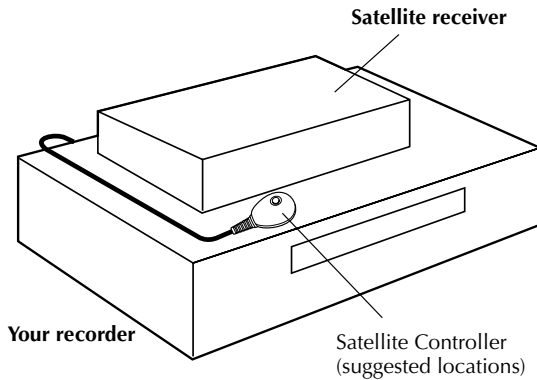

Installing Satellite Controller

1 Situate the Satellite Controller.

Place the Satellite Controller so that the path between its transmitter and the satellite receiver's remote sensor is unobstructed.

2 Attach the Satellite Controller.

Fix securely using the adhesive strip attached on the back of the Satellite Controller.

3 Make connections.

Be sure to connect the recorder's AV2 (L-2) IN/DECODER connector to the satellite receiver's 21-pin SCART connector.

NOTE:

When connecting your satellite receiver, refer to its instruction manual.

4 Connect the Satellite Controller to recorder.

Connect the Satellite Controller to the SAT CONTROL connector on the rear panel.

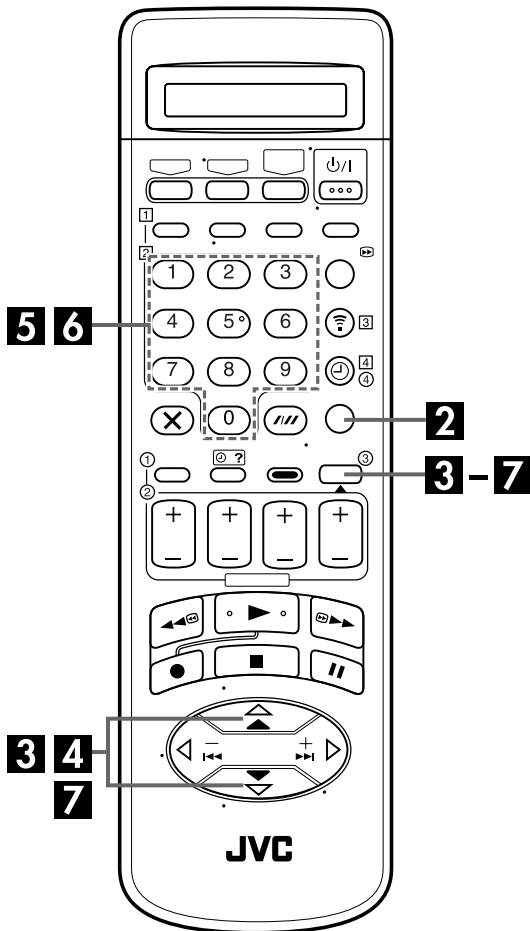

Setting satellite receiver's brand and channel

After installation, set the satellite receiver's brand and channel correctly; otherwise, the Satellite Controller cannot work correctly.

Turn on the TV and select the video channel (or AV mode).

1 Turn on the satellite receiver.

Turn on the satellite receiver's power.

2 Access the Main Menu screen on the recorder.

Press **MENU**.

3 Access the Initial Set screen.

Press $\Delta \nabla$ to move the highlight bar (pointer) to "INITIAL SET", then press **OK** or \triangleright .

4 Access the Sat Control Set screen.

Press $\Delta \nabla$ to move the highlight bar (pointer) to "SAT CONTROL SET", then press **OK** or \triangleright .

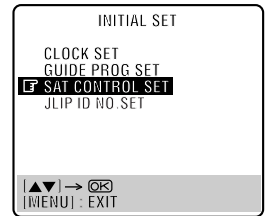

5 Enter the satellite receiver's brand.

Press the appropriate **number keys** to enter the brand code from the list on page 19, then press **OK**.

- If the brand code you entered is invalid, the code field will be reset. Enter the correct brand code again.
- If the recorder is in playback or recording mode, you cannot set the brand code.

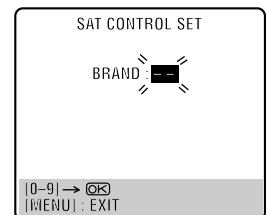

6 Select the satellite receiver's channel for testing.

Press the appropriate **number keys** to enter one of the channel positions on the satellite receiver, then press **OK**.

- You can select the channel position between 1 to 999.
- After pressing **OK**, the recorder enters the Test mode.

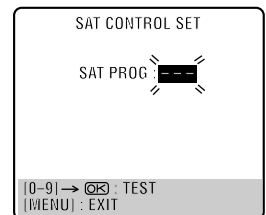

7 Check the result of the test.

If the satellite receiver's channel number has been changed to the same one as you set in step 6 ...

Press $\Delta \nabla$ to move the highlight bar (pointer) to "CHANGED TO ...", then press **OK** or \triangleright to finish the Sat Control Set mode.

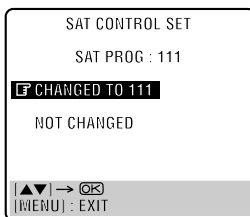

If the satellite receiver's channel number has not been changed correctly ...

Press $\Delta \nabla$ to move the highlight bar (pointer) to "NOT CHANGED", then press **OK** or \triangleright . Then perform the procedure again from step 5.

BRAND NAME	CODE
JVC	73
AMSTRAD	60, 61, 62, 63, 92
CANAL SATELLITE	81
CANAL +	81
D-BOX	85
ECHOSTAR	78, 79, 80
ECHOSTAR (VIA DIGITAL)	82
FINLUX	68
FORCE	89
GALAXIS	88
GRUNDIG	64, 65
HIRSCHMANN	64, 78
ITT NOKIA	68
JERROLD	75
KATHREIN	70, 71
LUXOR	68
MASCOM	93
MASPRO	70
NOKIA	87
PACE	65, 67, 74, 86, 92
PANASONIC	74
PHILIPS	66, 84
RFT	69
SAGEM	83
SALORA	68
SIEMENS	64
SKYMASTER	69
TPS	83
TRIAx	91
WISI	64

NOTES:

- The Satellite Controller may not work with all types of satellite receiver.
- For some satellite receivers, you need to set its channel input mode to 2-digit.
- If your satellite receiver has more than two channel modes, be sure to set to "All Channel Mode". For details, refer to the instruction manual of the satellite receiver.
- When selecting the satellite receiver's channel (see step 6), signals from the remote control may interfere with signals transmitted from the Satellite Controller. In this case, move the remote control as close to the recorder's infrared beam receiving window as possible.

T-V Link Functions

When you connect the recorder to your TV via a fully-wired 21-pin SCART cable (see pg. 10), the following functions are available. You can use these functions only with a TV offering T-V Link, etc.*

For details, refer to the instruction manual of your TV.

* Compatible with TVs offering T-V Link, EasyLink, Megalogic, SMARTLINK, Q-Link, DATA LOGIC or NexTVView Link via fully-wired 21-pin SCART cable. The degree of compatibility and available functions may differ by system.

NexTVView Link

You can download the EPG (Electronic Programme Guide) information from your TV for timer-programming on the recorder.

For details, refer to the instruction manual of your TV.

TV Auto Power On

The TV will turn on and be set to its AV mode automatically whenever you play a tape.

For details, refer to the instruction manual of your TV.

VCR Auto Standby

You can use your TV's remote control to turn off the recorder. For details, refer to the instruction manual of your TV.

Direct Rec

You can easily start recording the programme that you are watching on your TV. When you use this function, set "DIRECT REC" to "ON" (see pg. 65).

Basic Playback

Turn on the TV and select the video channel (or AV mode).

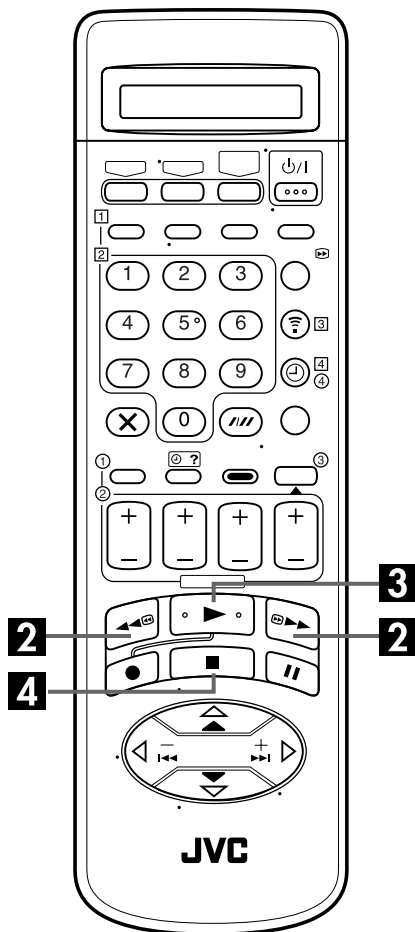
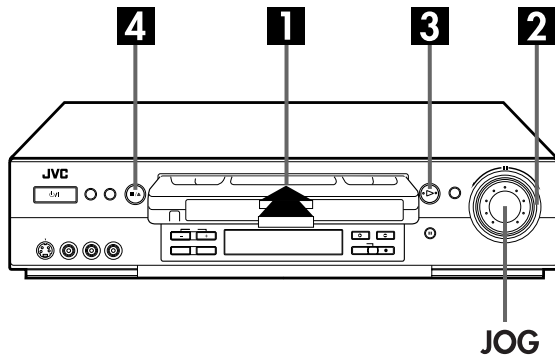

1 Load a cassette.

Make sure the window side is up, the rear label side is facing you and the arrow on the front of the cassette is pointed toward the recorder.

- Do not apply too much pressure when inserting.
- The recorder's power comes on automatically and the counter is reset to "0:00:00".
- While "----" is blinking on the front display panel, the tape will run for a few seconds to search for the tape number.
- If the record safety tab has been removed, playback begins automatically.

2 Find the programme start point.

If the tape is advanced past the start point, press ◀ or turn the **SHUTTLE** ring to the left. To go forward, press ▶ or turn the **SHUTTLE** ring to the right.

3 Start playback.

Press ▶. "BEST" appears blinking in the recorder's front display panel during automatic tracking. (☞ pg. 29)

4 Stop playback.

Press ■ on the remote control or ■/▲ on the recorder's front panel. Then press ■/▲ to remove the cassette.

Clean the video heads using a dry cleaning cassette — TCL-2UX — when:

- Rough, poor picture appears while a tape is played back.
- The picture is unclear or no picture appears.
- "USE CLEANING CASSETTE" appears on the screen (only with "O.S.D." set to "ON" (☞ pg. 65)).

Usable cassettes

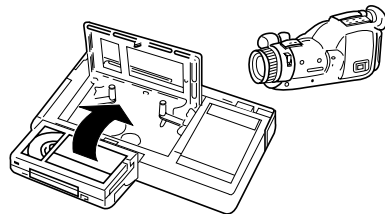

- Compact VHS camcorder recordings can be played on this video recorder. Simply place the recorded cassette into a VHS Cassette Adapter and it can be used just like any full-sized VHS cassette.
- This video recorder can record on regular VHS and Super VHS cassettes. While only VHS signals can be recorded on regular VHS cassettes*, both VHS and Super VHS signals can be recorded and played back using Super VHS cassettes.

* By using the S-VHS ET function, it is possible to record and play back with S-VHS picture quality on VHS cassettes with this recorder.

Playback Features

NOTE:

Refer to the **SHUTTLE** ring illustration on the right as you read the following procedures.

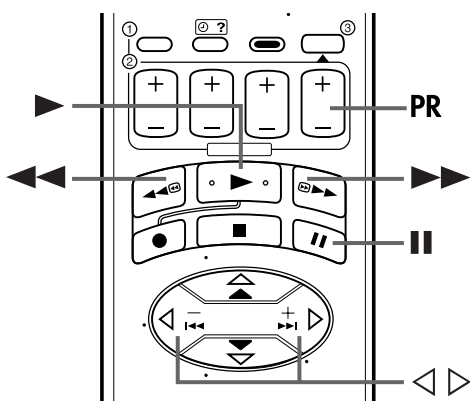
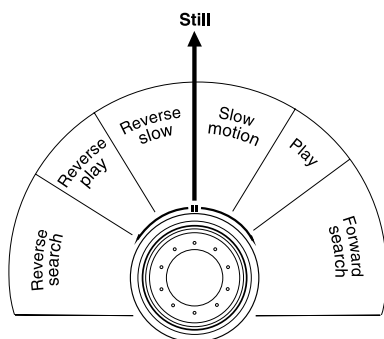

ATTENTION

- Picture may not appear during high-speed search with an LP/EP-recorded tape.
- Noise may appear or the picture may appear distorted with an EP-recorded tape during still, slow motion, frame-by-frame playback or variable speed search.
- In the high-speed search, still, slow motion or frame-by-frame playback mode, the picture will be distorted, and there will be a loss of colour.
- When normal playback resumes from search, still, slow motion or frame-by-frame playback, the picture may jitter vertically momentarily depending on the type of TV being used.

Variable Speed Search

During playback or still, turn the **SHUTTLE** ring to the right for forward variable-speed search, or to the left for reverse variable-speed search (refer to the illustration above).

OR

During playback, press ◀ or ▶.

- The more times you press, the faster the playback picture moves.
- To decrease speed, press the button for the opposite direction.

Still Picture/Frame-By-Frame Playback

1 Pause during playback.

Press **II**.

- If there is vertical jitter, use the **PR** buttons to correct the picture.

2 Activate frame-by-frame playback.

Turn the **JOG** dial to the right for forward frame-by-frame playback, or to the left for reverse frame-by-frame playback.

OR

Press **II**.

OR

Press ◀ or ▶.

Slow Motion

During playback or still, turn the **SHUTTLE** ring to the right for forward slow motion, or to the left for reverse slow motion (refer to the illustration on the left).

OR

During still picture, press and hold **II** for 2 seconds, then release. Press **II** and release again to return to still picture.

OR

During still picture, press and hold ◀ or ▶. Release to return to still picture.

NOTE:

Manual tracking is possible during slow motion playback. (☞ pg. 23)

High-Speed (Turbo) Search

During playback or still, turn the **SHUTTLE** ring all the way to the right for forward high-speed search, or to the left for reverse high-speed search. Releasing **SHUTTLE** ring resumes still picture playback.

- For forward high-speed search, turn the **SHUTTLE** ring all the way to the right and release it within 1 second.
- For reverse high-speed search, turn the **SHUTTLE** ring all the way to the left and release it within 1 second.

OR

During playback or still, press ►► for forward high-speed search, or ◀◀ for reverse high-speed search.

NOTE:

For short searches, press and hold ►► or ◀◀ for over 2 seconds during playback or still picture. When released, normal playback resumes.

To resume normal playback, press ►.

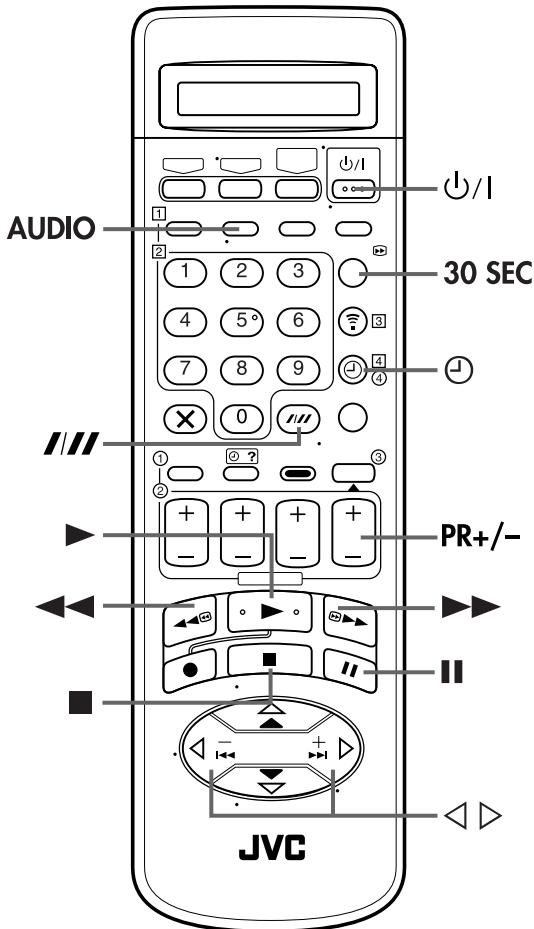
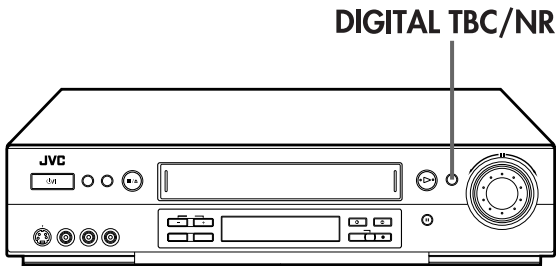

Skip Search

During playback, press **30 SEC** 1 to 4 times to skip over unwanted sections. Each press initiates a 30-second period of fast-motion playback. Normal playback resumes automatically.

To resume normal playback during a Skip Search, press ▶.

Index Search

Your recorder automatically marks index codes at the beginning of each recording. This function gives you quick access to any one of 9 index codes in either direction.

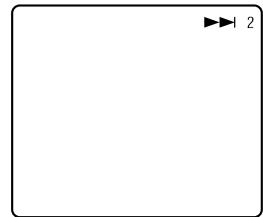

NOTE:

Before starting, make sure the recorder is in the Stop mode.

Activate Index Search.

Press ◀ or ▶ (I◀◀ or ▶▶I). “I◀◀ 1” or “▶▶I 1” is displayed on the TV screen and search begins in the corresponding direction.

- To access index codes 2 through 9, press ◀ or ▶ repeatedly until the correct index number is displayed.

Example:

To locate the beginning of B from the current position, press ◀ twice.

To locate the beginning of D from the current position, press ▶ once.

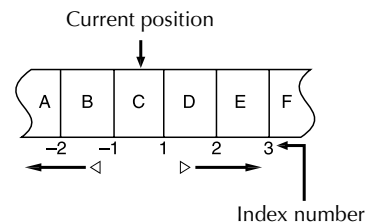

- When the specified index code is located, playback begins automatically.

Next Function Memory

The Next Function Memory "tells" the recorder what to do after rewinding. Before continuing, make sure the recorder is in the Stop mode.

- a- For Automatic Start Of Playback
Press ◀◀, then press ▶ within 2 seconds.
- b- For Automatic Power Off
Press ◀◀, then press ⏻/1 within 2 seconds.
- c- For Automatic Timer Standby
Press ◀◀, then press ⊕ (TIMER) within 2 seconds.

Digital TBC/NR

Your recorder is equipped with the Digital TBC (Time Base Corrector) that removes jitter from fluctuating video signals to deliver a stable picture even with old tapes and rental cassettes. The on/off of Digital 3-DNR (Noise Reduction) which cuts noise and enables clear picture reproduction is also linked to this function.

* The default setting is on.

We recommend that you use Digital TBC/NR when...

- ... playing back a tape recorded on a camcorder.
- ... playing back a tape repeatedly used.
- ... using this video recorder as the source player for editing.

Activate Digital TBC/NR.

Press **DIGITAL TBC/NR** so that the button lights up.

- To turn off Digital TBC/NR, press **DIGITAL TBC/NR** again so that the light goes off.

NOTES:

- If you play back a tape recorded under poor TV reception condition, the picture may become more stable with Digital TBC/NR set to off.
- When Digital TBC/NR is set to on, if you play back a tape where certain types of signals are recorded (using a PC or some character generators), the playback picture may be distorted. If this is the case, turn off Digital TBC/NR.
- When playing back a MESECAM tape, Digital TBC/NR does not function even though the DIGITAL TBC/NR button is lit.

Repeat Playback

Your recorder can automatically play back the whole tape 100 times repeatedly.

1 Start playback.

Press ▶.

2 Activate Repeat Playback.

Press ▶ and hold for over 5 seconds, then release.

- The Play indicator (▶) on the front display panel blinks slowly.
- After playing back a tape 100 times, the recorder stops automatically.

3 Stop Repeat Playback.

Press ■ at any time.

- Pressing ▶, ◀◀, ▶▶ or || also stops Repeat Playback.

NOTE:

Repeat playback is not possible with a cassette recorded in EP mode.

Manual Tracking

Your recorder is equipped with automatic tracking control. During playback, you can override this and adjust the tracking manually by pressing the **PR** buttons.

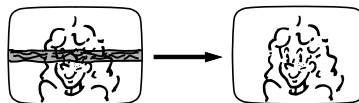

1 Override automatic tracking.

Press **///** on the remote control.

2 Adjust the tracking manually.

Press **PR +** or **-**.

3 Return to automatic tracking.

Press **///** on the remote control.

NOTE:

When a new tape is inserted, the recorder enters the automatic tracking mode automatically.

Soundtrack Selection

Your recorder is capable of recording three soundtracks (HI-FI L, HI-FI R and NORM) and will play back the one you select.

During Playback

Pressing **AUDIO** changes the soundtrack as follows:

TRACK		USE
Recorder's Front Display Panel	On-Screen Display	
▶ + ◀	HI FI L ▶ ◀ R	For Hi-Fi stereo tapes
▶	HI FI L ▶	For main audio of Bilingual tapes
◀	HI FI ◀ R	For sub audio of Bilingual tapes
NORM	NORM	For audio-dubbed tapes
▶ + ◀ + NORM	HI FI NORM	For audio-dubbed tapes

NOTES:

- "▶ + ◀" should normally be selected. In this mode, Hi-Fi stereo tapes are played back in stereo, and the normal audio track is played back automatically for tapes with only normal audio.
- For instructions on recording stereo and bilingual programmes, refer to page 28.
- "O.S.D." must be set to "ON" or the on-screen displays will not appear (☞ pg. 65).

Basic Recording

Turn on the TV and select the video channel (or AV mode).

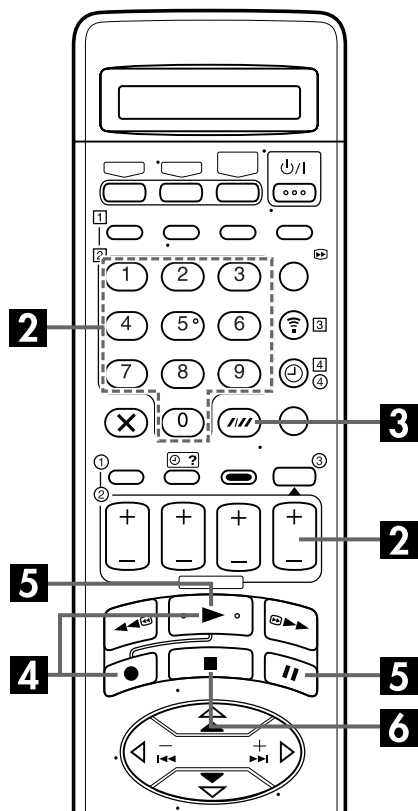
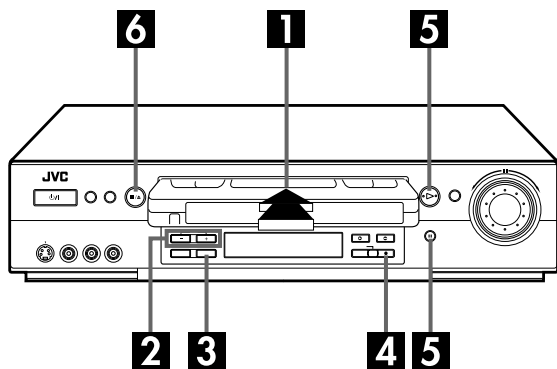

Recording Resume Function

If there is a power outage during recording, Instant Timer Recording (☞ pg. 25) or timer recording (☞ pg. 30, 32), the recording will resume automatically when power is restored to the recorder unless the recorder's memory backup has expired.

1 Load a cassette.

Insert a cassette with the record safety tab intact.

- The recorder's power comes on automatically and the counter is reset to "0:00:00".
- While "----" is blinking on the front display panel, the tape will run for a few seconds to search for the tape number.

2 Choose a programme.

Press **PR +/-** or the **number keys** to select the channel you wish to record.

3 Set the tape speed.

Press **SP/LP/EP (//)**. Check the SP/LP/EP indicator on the recorder's front display panel to confirm the selected tape speed.

- In EP mode, the recording time is extended three times.
- If you record a programme in EP mode on this recorder, it is recommended to play back the EP-recorded tape on this recorder.
- It is not possible to select EP mode if "COLOUR SYSTEM" is set to "MESECAM". (☞ pg. 67)

4 Start recording.

Press and hold **●** and press **▶** on the remote control, or press **●** on the recorder.

B.E.S.T. takes place at the beginning of both the first SP and the first LP (or EP) recording after inserting the cassette. (☞ pg. 29)

If "DIRECT REC" is set to "ON", the programme that appears on the TV screen will be recorded (☞ pg. 65).

5 Pause/Resume recording.

Press **II**. Press **▶** to resume recording.

6 Stop recording.

Press **■** on the remote control or **■/▲** on the recorder. Then press **■/▲** to remove the cassette.

Accidental erasure prevention

To prevent accidental recording on a recorded cassette, remove its safety tab. To record on it later, cover the hole with adhesive tape.

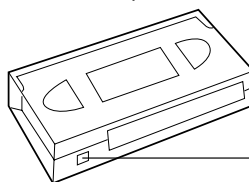

Record safety tab

Recording Features

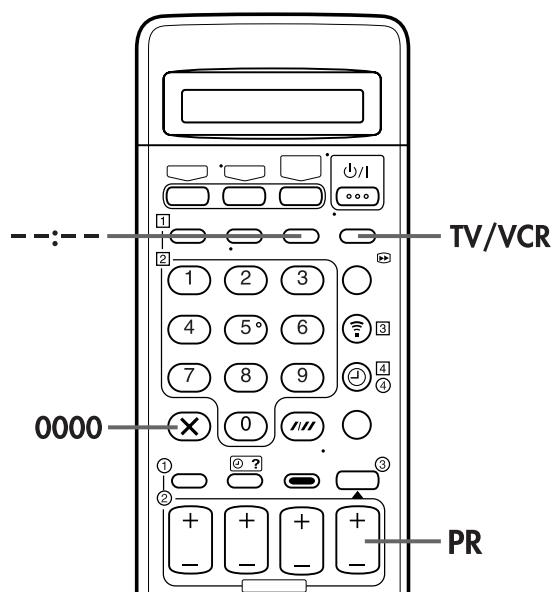
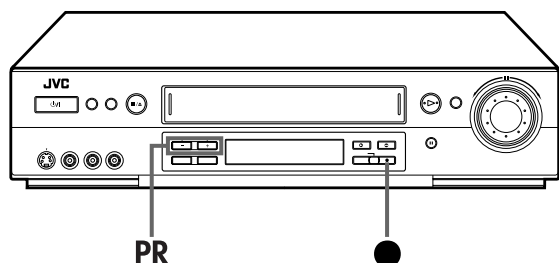

Record One Programme While Watching Another

If your recorder is connected to the TV via the AV connection, press **TV/VCR**. The recorder's VCR indicator and the TV broadcast being recorded disappear. Once recording is in progress, all you need to do is to set the channel controls on the TV for the station you wish to view.

- The programme selected with the TV's channel controls appears on the TV screen, while the one selected with the recorder's **PR** buttons is recorded on the tape.
- If a decoder is connected to the recorder (see pg. 62), you can select a scrambled channel as well with the TV channel controls.

Instant Timer Recording (ITR)

This easy method lets you record for from 30 minutes to 6 hours (selectable in 30-min. increments), and shuts the recorder off after recording is finished.

1 Start recording.

Press ● on the recorder.

2 Engage the ITR mode.

Press ● again. "○" blinks and "0:30" appears on the front display panel.

3 Set the recording duration.

If you want to record for more than 30 minutes, press ● to extend the time. Each press extends recording time by 30 minutes.

NOTE:

You can only perform ITR using the ● button on the recorder's front panel.

Elapsed Recording Time Indication

1 Set the counter display.

Press --:-- until a counter reading appears on the front display panel.

2 Reset the counter.

Press **0000** before starting recording or playback.

- The counter is reset to "0:00:00" and shows the exact elapsed time as the tape runs. You can check the exact time of a recording or playback.

Tape Remaining Time

Press --:-- until the time remaining on the tape appears.

- The front display panel shows the tape remaining time with "▲" displayed.
- By pressing the --:-- button, you can change the display to show the counter reading, channel position*, clock time or tape remaining time.

* Channel position is not displayed during playback.

NOTE:

Depending on the type of tape being used, the tape remaining time reading may not appear right away, or is not correct. "--:--" may sometimes appear, or the display may blink on occasion.

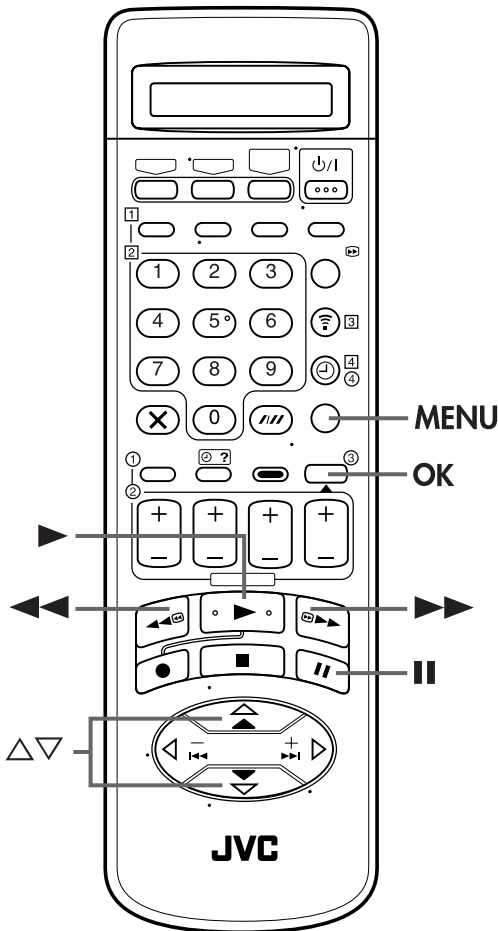
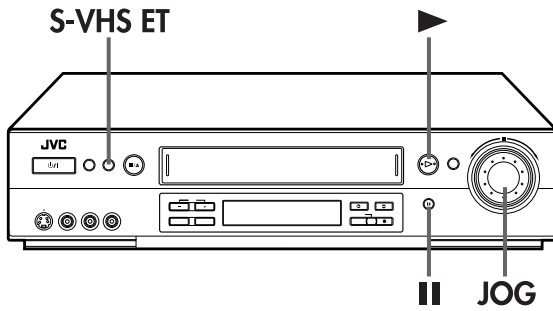

Retake

You can cut out unnecessary parts of a TV programme while you are recording it.

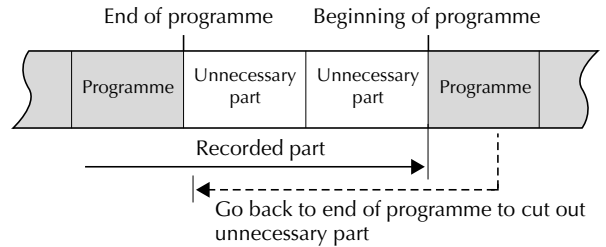

1 Engage the Record-Pause mode.

Press **II** during recording.

2 Locate the start point.

Turn the **JOG** dial to the left or right (or hold down ◀◀ or ▶▶) and release it when you reach the point where you want to resume recording.

- Your recorder returns to the Record-Pause mode.

3 Resume recording.

Press ▶ when you wish to resume recording.

NOTES:

- Retake function does not work during Direct Rec (pg. 19, 65).
- Noise may appear when Retake function is used at the part that is recorded in EP mode.

Super VHS ET (S-VHS ET)

— Recording on VHS cassettes with S-VHS quality

You can record in SP mode on VHS cassettes with S-VHS picture quality. Tapes recorded using this function can be played back on a recorder equipped with the S-VHS ET function.

- You can activate the S-VHS ET function only before you start recording on a VHS cassette.
- Before recording, make sure that "B.E.S.T." is set to "ON". (ⓘ pg. 65)

Engage the S-VHS ET mode.

Press **S-VHS ET** on the recorder. The button lights up.

- The S-VHS indicator lights up on the front display panel.
- To disengage the S-VHS ET mode, press **S-VHS ET**. The button's light goes off.

NOTES:

- You cannot activate the S-VHS ET function ...
 - ... while recording is in progress.
 - ... while timer-recording or Instant Timer Recording (ⓘ pg. 25) is in progress.
 - ... while B.E.S.T. (ⓘ pg. 29) is in progress.
- The S-VHS ET function does not work ...
 - ... with S-VHS cassettes.
 - ... with recordings in LP/EP mode.
- To keep the highest quality recording and playback pictures over a long period of time, S-VHS recording on S-VHS cassettes is recommended.
- Use of high grade tapes is recommended for S-VHS ET recordings. On some tapes, picture quality will not improve even if the S-VHS ET function is used. Check the recording quality before you start important recordings.
- You can play back a tape recorded using the S-VHS ET function on most of S-VHS recorders and of VHS recorders equipped with SQPB (S-VHS QUASI PLAYBACK) function. (Notice some recorders are not compatible with the S-VHS ET function.)
- While playing back a tape recorded using the S-VHS ET function on some recorders, noise may appear. (If playback picture becomes blurred or interrupted, use a cleaning cassette.)
- In the high-speed search, still, slow-motion or frame-by-frame playback modes (ⓘ pg. 21), noise may appear. If these modes are performed frequently on a tape recorded using the S-VHS ET function, the tape may be damaged and the picture may be deteriorated.

Audio Recording Level Control

Your recorder allows manual adjustment of the audio recording level.

1 Access the Main Menu screen.

Press **MENU**.

2 Access the Recording Level Control screen.

Press Δ / ∇ to move the highlight bar (pointer) to "REC LEVEL CTL", then press **OK** or \triangleright .

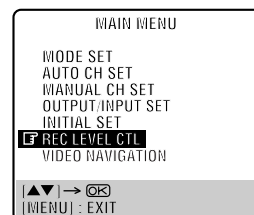

3 Adjust the audio recording level.

Press Δ or ∇ .

- Press Δ or ∇ briefly 5 times to move the on-screen's audio levels by one division on the scale. To move the audio levels faster, press and hold Δ or ∇ .
- Adjust the recording level while watching the audio level indicator on the recorder's front display panel. Set the level so that maximum volume causes the indicator to vary between 0dB to 4dB.

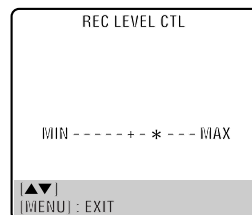

4 Return to the normal screen.

Press **MENU**.

NOTES:

- Noise will increase if the recording level is too low, while distortion will increase if the level is too high.
- When you finished audio recording, be sure to set the level control back to its centre position.

Receiving Stereo and Bilingual Programmes

Your recorder is equipped with a Sound-Multiplex decoder (A2) and a Digital stereo sound decoder (NICAM) making reception of stereo and bilingual broadcasts possible.

When the channel is changed, the type of broadcast being received will be displayed on the TV screen for a few seconds.

Type of Broadcast Being Received	On-screen Display
A2 Stereo	ST
A2 Bilingual	BIL.
Regular Monaural	(none)
NICAM Stereo	ST NICAM
NICAM Bilingual	BIL. NICAM
NICAM Monaural	NICAM

- To listen to a stereo programme, press **AUDIO** until "ST" and "HIFI L R" appear on the front display panel or "HIFI L R" appears on the TV screen.
- To listen to a bilingual programme, press **AUDIO** until "BIL" or "HIFI L R" appears on the front display panel, or "HIFI L R" or "HIFI L R" appears on the TV screen (as required).
- To listen to the standard (Regular Monaural) audio while receiving a NICAM broadcast, press **AUDIO** until "NORM" appears on the front display panel or the TV screen.

NOTE:

"O.S.D." must be set to "ON" or the on-screen displays will not appear (☞ pg. 65).

To Record Stereo and Bilingual Programmes (A2)

Stereo programmes are automatically recorded in stereo on the Hi-Fi audio track (with the normal audio track recording mixed L and R channel sound).

- Bilingual programmes are automatically recorded in bilingual on the Hi-Fi audio track. The main soundtrack will be recorded on the normal audio track.

To Record NICAM Stereo and Bilingual Programmes

The NICAM audio programme will be recorded on the Hi-Fi audio track, and the standard audio programme will be recorded on the normal audio track.

NOTES:

- If the quality of stereo sound being received is poor, the broadcast will be received in monaural with better quality.
- Before playing back a programme recorded in stereo, or a bilingual programme, refer to "Soundtrack Selection" on page 23.

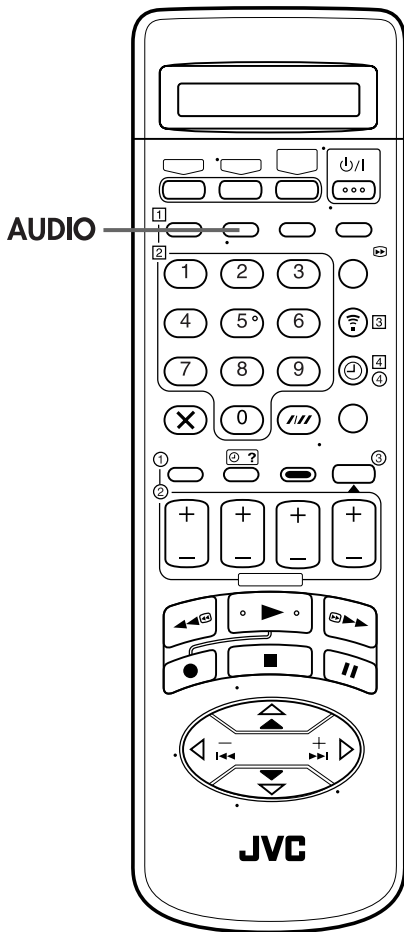

B.E.S.T. Picture System

The B.E.S.T. (Biconditional Equalised Signal Tracking) system checks the condition of the tape in use during playback and recording, and compensates to provide the highest-possible playback and recording pictures. You can set "B.E.S.T." to "ON" or "OFF" to your preference (☞ pg. 65).

Playback

The recorder assesses the quality of the tape once you initiate playback.

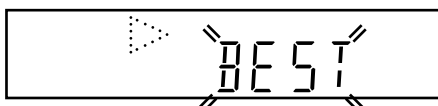

- The recorder adjusts the playback picture quality based on the quality of the tape in use.
- B.E.S.T. is active during automatic tracking. "BEST" appears blinking on the recorder's front display panel.

NOTES:

- When watching a tape recorded with "B.E.S.T." set to "ON", it is recommended that you leave B.E.S.T. on during playback as well.
- When watching a rental tape or one recorded on another video recorder, or when using this recorder as the player for editing, set B.E.S.T. to your preference (☞ pg. 65).
- "BEST" only appears at the beginning of automatic tracking. Even though it doesn't appear after that, the B.E.S.T. function is operative.

Recording

The recorder assesses the quality of the tape once you initiate recording.

DURING B.E.S.T.

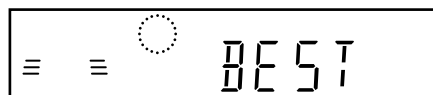

B.E.S.T. COMPLETE

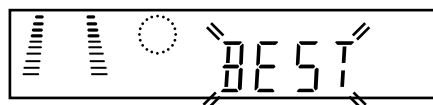

- The recorder spends approximately 7 seconds assessing the condition of the tape, then begins recording.

NOTES:

- The B.E.S.T. system works for both SP and LP (or EP) modes only after a tape has been inserted and the Record mode is first initiated. It does not work during recording.
- The B.E.S.T. system does not work while Automatic Satellite Programme Recording is in progress (☞ pg. 36).
- In the case of timer recordings, the B.E.S.T. system works before recording is initiated.
- Once the cassette is ejected, the B.E.S.T. data is cancelled. The next time the cassette is used for recording, B.E.S.T. is re-performed.
- Pressing the recorder's ● button while "BEST" is displayed does not start Instant Timer Recording (☞ pg. 25).

ATTENTION

Since the B.E.S.T. system works before recording actually starts, there is a delay of approximately 7 seconds after ● and ► on the remote control are pressed, or ● on the recorder is pressed. To make sure you record the desired scene or programme in its entirety, first perform the following steps:

- 1 Press and hold ■ and press ● to engage the Record Pause mode.
 - The recorder then automatically checks the condition of the tape and, after approximately 7 seconds, re-enters Record Pause mode.
 - 2 Press ► to start recording.
- If you want to bypass the B.E.S.T. system and begin recording immediately, set "B.E.S.T." to "OFF" (☞ pg. 65).

SHOWVIEW® Timer Programming

Before performing the SHOWVIEW Timer Programming:

- Make sure that the recorder's built-in clock is set properly.
- Insert a cassette with the safety tab in place. The recorder will come on automatically.
- Turn on the TV and select the video channel (or AV mode).

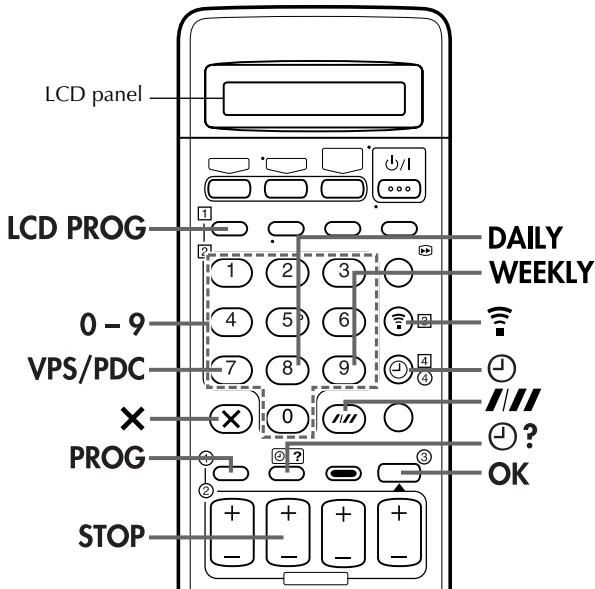

With the SHOWVIEW system, timer programming is greatly simplified because each TV programme has a corresponding code number which your recorder is able to recognize. You can use the remote control with LCD panel to enter the SHOWVIEW number.

1 Access the SHOWVIEW display.

Press **LCD PROG**.

The LCD panel looks like this:

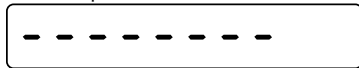

2 Enter the SHOWVIEW number.

Press the **number keys** to enter the SHOWVIEW number of a programme you wish to record. Then press **OK**.

- If you make a mistake, press **X** and input the correct number. The SHOWVIEW number you enter appears on the LCD panel:

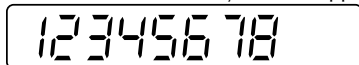

Then go to step 3 in the right column.

You can use the on-screen display to enter the SHOWVIEW number.

1 Access the SHOWVIEW screen.

Press **PROG**.

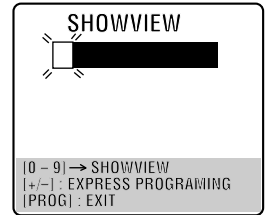

The front display panel looks like this:

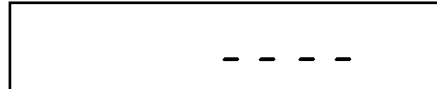

2 Enter the SHOWVIEW number.

Press the **number keys** to enter the SHOWVIEW number of a programme you wish to record. Then press **OK**.

- If you make a mistake, press **X** and input the correct number.

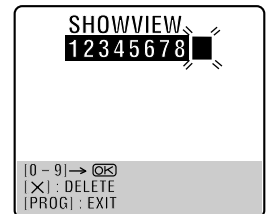

The SHOWVIEW number you enter appears on the front display panel with only a 4-digit number:

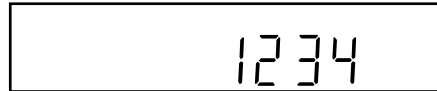

3 Access the SHOWVIEW Program screen.

The SHOWVIEW Program screen appears (if you're just starting out, "P1" appears).

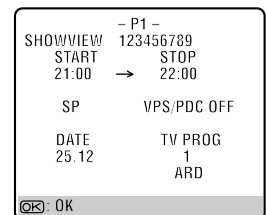

The front display panel shows the programme start time. Pressing **⊕ ?** changes the display to the programme stop time, then the date and channel position.

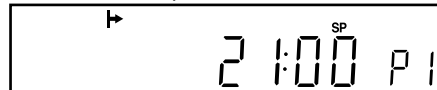

IMPORTANT

Make sure the channel position number you wish to record is displayed; if not, see "SHOWVIEW" System Setup" on page 75 and set the Guide Program number correctly.

- If the number you entered is invalid, "ERROR" appears on the TV screen and "Err" appears on the front display panel. Press **X** and input a valid SHOWVIEW number.
- If the "GUIDE PROG SET" screen appears, see "ATTENTION" on page 31.

4 Set the tape speed.

Press **SP/LP/EP (///)**.

- It is not possible to select EP mode if "COLOUR SYSTEM" is set to "MESECAM". (☞ pg. 67)

5 Set the VPS/PDC mode.

Press **VPS/PDC** to select "ON" or "OFF".

- If "VPS/PDC ON" is displayed on the TV screen or "VPS/PDC" is lit on the front display panel, VPS/PDC is set to ON.
- If "VPS/PDC OFF" is displayed on the TV screen or "VPS/PDC" is not lit on the front display panel, VPS/PDC is set to OFF. ☞ "VPS/PDC Recording" on page 33.

6 Return to the normal screen.

Press **PROG** or **OK**. "PROGRAM COMPLETED" appears on the TV screen for about 5 seconds, then the normal screen appears. If "PROGRAM OVERLAPPED" appears on the TV screen and "Err" on the front display panel, see page 35.

- Repeat steps 1 – 6 for each additional programme.

7 Engage the recorder's timer mode.

Press **⊖ (TIMER)**. The recorder turns off automatically and "⊖" appears on the front display panel.

- To disengage the timer mode, press **⊖ (TIMER)** again.

NOTES:

- To Change The Stop Time press **STOP +/-** in step 3. You can compensate for anticipated programme schedule delays.
- To Timer-Record Weekly Or Daily Serials in step 3, press **WEEKLY (number key "9")** for weekly serials or **DAILY (number key "8")** for daily serials (Monday – Friday). Either "WEEKLY" or "DAILY" appears on the TV screen. Pressing the button again makes the corresponding indication disappear.
- You can programme this recorder to timer-record as many as 8 programmes. If you try to programme the recorder to record a ninth, "PROGRAM FULL" appears on the TV screen and "FULL" appears on the front display panel. To record the extra programme, you must first cancel any unnecessary programmes (☞ pg. 34).
- It is not possible to timer-record a TV programme with a SHOWVIEW number which starts with "0".

Satellite Receiver Users

To timer-record a satellite broadcast using the SHOWVIEW system:

- Perform "Satellite Receiver Control Setting" on page 17.
- Perform steps 1 – 7. In step 3, the front display panel shows "L2" for the channel position. In step 5, you cannot set "VPS/PDC" to "ON".
- Leave the satellite receiver's power on.

ATTENTION

Guide Program Number Set

"GUIDE PROG SET" appears after performing step 3 if the Guide Program number for the SHOWVIEW number you entered has not been set.

If you want to set the Guide Program number for the satellite broadcast station, press the **number key "0"** to change "TV PROG" to "SAT". Press **Δ∇** to input the channel position number on which your recorder or satellite receiver receives that station, then press **OK** or **▷** to set the Guide Program number. The SHOWVIEW Program screen appears.

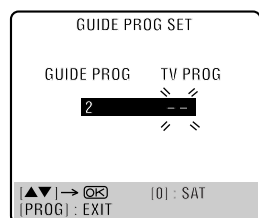

(Example)
To timer-record a ZDF programme with the SHOWVIEW system.
* If your recorder receives ZDF on the channel position 2, press **OK** or **▷** after entering "2".

Express Timer Programming

Before performing Express Timer Programming:

- Make sure that the recorder's built-in clock is set properly.
- Insert a cassette with the safety tab in place. The recorder will come on automatically.
- Turn on the TV and select the video channel (or AV mode).

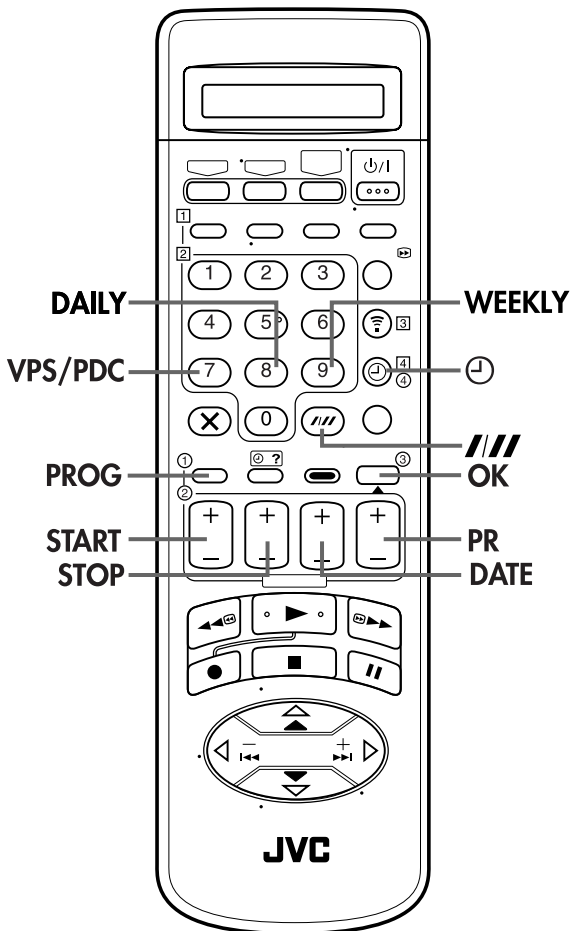

If you do not know the SHOWVIEW number for the programme you wish to record, use the following procedure to set your recorder to timer-record the programme.

1 Access the SHOWVIEW screen.

Press **PROG**.

2 Access the Programme screen.

Press **START+/-**. (If you're just starting out, "P1" appears.)

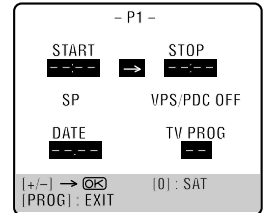

The front display panel looks like this:

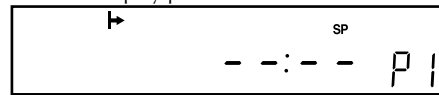

3 Enter the programme start time.

Press **START+/-** to enter the time you want recording to start.

- Press and hold **START+/-** to move in 30-minute increments, or press and release repeatedly to move 1 minute at a time.

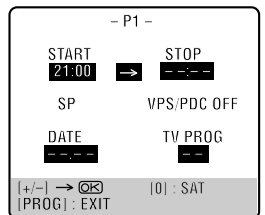

The front display panel looks like this:

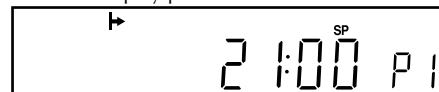

4 Enter the programme stop time.

Press **STOP+/-** to enter the time you want recording to stop.

- Press and hold **STOP+/-** to move in 30-minute increments, or press and release repeatedly to move 1 minute at a time.

5 Enter the programme date.

Press **DATE+/-**.

- The current date appears on the TV screen. The date you enter appears in its place.

6 Enter the channel position.

Press **PR+/-**.

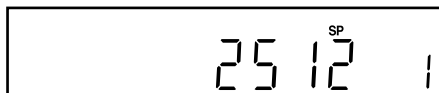
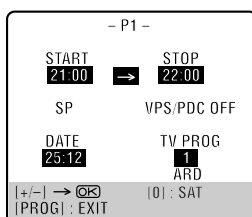

7 Set the tape speed.

Press **SP/LP/EP (///)**.

- It is not possible to select EP mode if "COLOUR SYSTEM" is set to "MESECAM". (☞ pg. 67)

8 Set the VPS/PDC mode.

Press **VPS/PDC** to select "ON" or "OFF".

- If "VPS/PDC ON" is displayed on the TV screen or "VPS/PDC" is lit on the front display panel, VPS/PDC is set to ON.
- If "VPS/PDC OFF" is displayed on the TV screen or "VPS/PDC" is not lit on the front display panel, VPS/PDC is set to OFF. ☞ "VPS/PDC Recording" in the right column

9 Return to the normal screen.

After confirming all information is correct, press **PROG** or **OK**. "PROGRAM COMPLETED" appears on the TV screen for about 5 seconds, then the normal screen appears. If "PROGRAM OVERLAPPED" appears on the TV screen and "Err" on the front display panel, see page 35.

- Repeat steps 1 – 9 for each additional programme.

10 Engage the recorder's timer mode.

Press **⊖ (TIMER)**. The recorder turns off automatically and "⊖" appears on the front display panel.

- To disengage the timer mode, press **⊖ (TIMER)** again.

To Timer-Record Weekly Or Daily Serials . . .

. . . anytime during steps 2 through 9, press **WEEKLY (number key "9")** for weekly serials or **DAILY (number key "8")** for daily serials (Monday – Friday). Either "WEEKLY" or "DAILY" appears on the TV screen. Pressing the button again makes the corresponding indication disappear.

NOTE:

You can programme this recorder to timer-record as many as 8 programmes. If you try to programme the recorder to record a ninth, "PROGRAM FULL" appears on the TV screen and "FULL" appears on the front display panel. To record the extra programme, you must first cancel any unnecessary programmes (☞ pg. 34).

Satellite Receiver Users

To timer-record a satellite broadcast using Express Timer Programming:

- 1 Perform "Satellite Receiver Control Setting" on page 17.
- 2 Perform steps 1 – 10. In step 6, press the **number key "0"** to change "TV PROG" to "SAT". The front display panel shows "L2" for the channel position. Then press **PR+/-** to enter the channel position for the satellite broadcast. In step 8, you cannot set "VPS/PDC" to "ON".
- 3 Leave the satellite receiver's power on.

VPS/PDC Recording

Now available from some TV stations, PDC (Programme Delivery Control) and VPS (Video Programme System) are service designed to assure safe, accurate timer recording. With this system, special code signals are transmitted together with the audio/video signals. These code signals control your video recorder and have precedence over the advertised times you may have preset into the timer. This means that your recorder will start and stop recording when the preset TV programmes actually start and end — even if the broadcast time of a preset TV programme is changed.

NOTES:

- When you use Express Timer Programming, set the start time (VPS or PDC time) exactly as advertised in the TV listing. A different time than advertised will result in no recording.
- VPS/PDC recording is also possible when a satellite receiver or a cable system is connected to AV2 (L-2) IN/DECODER connector on your recorder.
- VPS/PDC recording is also possible via the AV1 (L-1) IN/OUT connector.

How to check if the station being received transmits a VPS/PDC signal

- 1 Press **--:--** until the channel position appears on the front display panel.
- 2 Hold down **START+** for about 5 seconds. "VPS/PDC" appears blinking on the front display panel. If a VPS/PDC signal is detected from the station, "VPS/PDC" will stop blinking. If no VPS/PDC signal is detected from the station, "VPS/PDC" will blink at a slower rate.
- 3 Press **--:--** or **START+** again to return to normal display.

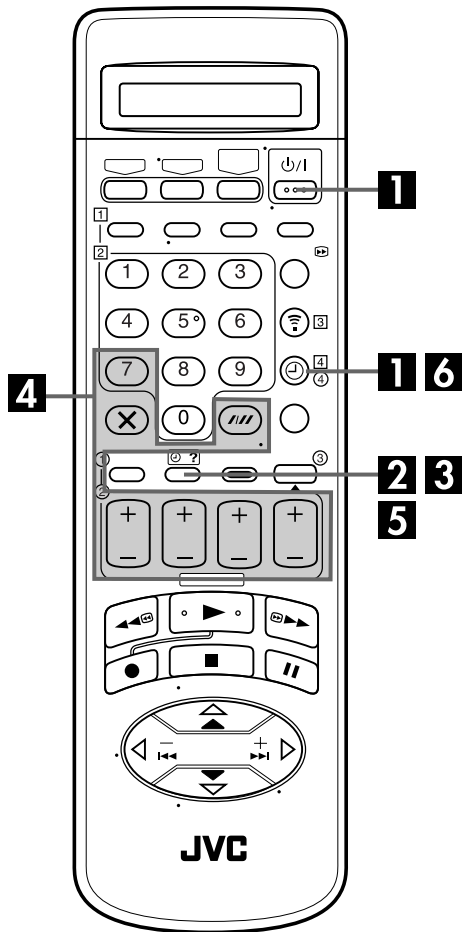

Check, cancel and change programmes

1 Disengage the timer mode.

Press **TIMER**, then press **power**.

2 Access the Programme Check screen/display.

Press **TIMER ?**.

	START	STOP	CH	DATE
1	8:00	10:00	3	24.12
2	10:00	10:45	2	25.12
3	11:30	13:00	1	25.12
4				
5				
6				
7				
8				

TIMER ? : NEXT

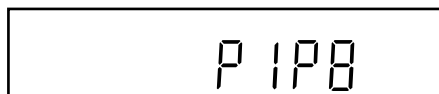

3 Access the Programme screen/display.

Press **TIMER ?** again to check more information. Each time you press **TIMER ?**, the next programme's information appears.

- P1 -	
START	STOP
8:00	10:00
SP	VPS/PDC OFF
DATE	TV PROG
24.12	3
	WDR

TIMER ? : NEXT

The front display panel shows the programme start time. Pressing **OK** changes the display to the programme stop time, then the date and the channel position.

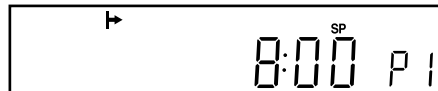

To cancel or change a programme...

4 Cancel or change a programme.

Press **X** to cancel a programme. To change programme settings, press the appropriate button: **START+/-**, **STOP+/-**, **DATE+/-**, **PR+/-**, **VPS/PDC** and/or **SP/LP/EP (///)**.

- You can change "TV PROG" to "SAT" for the channel position by pressing the **number key "0"**.

5 Return to the normal screen/display.

Press **TIMER ?** as many times as necessary. If there are still some programmes remaining, go on to step 6.

6 Return to the timer mode.

Press **TIMER** (TIMER).

NOTE:

You can also check the programmes on the front display panel even if the recorder's power is off (unless the recorder is in the Power Save mode **PS** pg. 66) or the recorder is in the timer mode; however, it is not possible to cancel or change the programmes.

When programmes overlap each other

If "PROGRAM OVERLAPPED" appears, you have another programme overlapping the programme you have just made. The Programme Check screen appears and conflicting programmes will start blinking.

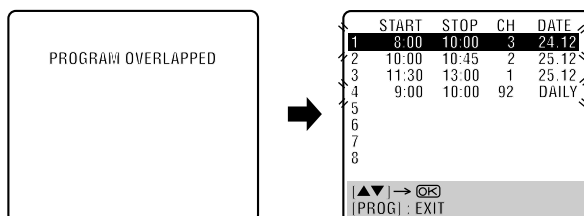
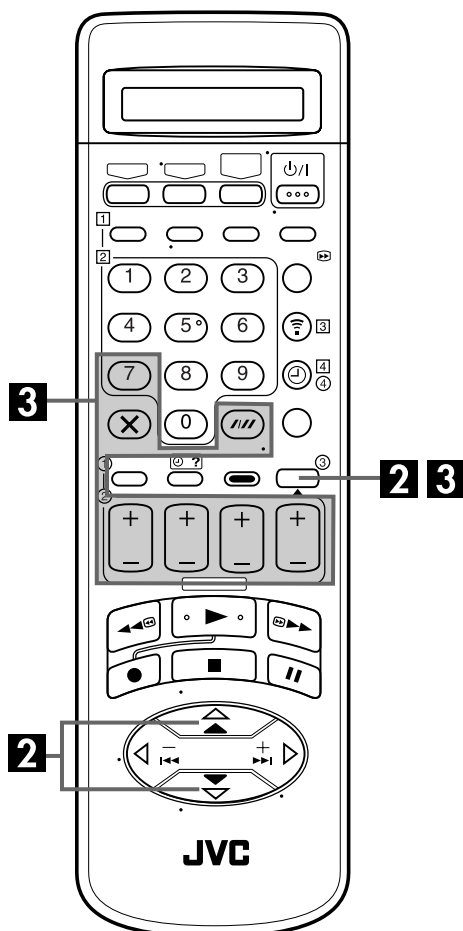

Example: Programme 1 (you have just made) and Programme 4 overlap each other.

1 Confirm the overlapping programmes.

Overlapping programmes blink on the TV screen.

2 Select the programme to modify.

Press Δ / ∇ , then press **OK** or \triangleright .

- You can only select one of the overlapping programmes.

NOTE:

If you do not mind this overlap, press **PROG** to finish the timer programme setting. The programme with the lower programme number will be recorded and the other one will not be recorded correctly. If no changes are made for approximately 1 minute, the recorder will return to the normal screen.

3 Cancel or change programme setting.

To cancel a programme, press **X** when the Programme screen you do not want is shown. "PROGRAM COMPLETED" appears on the TV screen for about 5 seconds, then the normal screen appears.

To change a programme, press the appropriate button: **START+/-**, **STOP+/-**, **DATE+/-**, **PR+/-**, **VPS/PDC** and/or **SP/LP/EP (///)** when the Programme screen on which you want to make changes is shown, then press **OK**. "PROGRAM COMPLETED" appears on the TV screen for about 5 seconds, then the normal screen appears.

NOTE:

If the overlap is not yet solved, or another overlap occurs with the timer programme setting after making the last correction on a programme, the conflicting programmes will be shown on the Programme Check screen again. Repeat the above steps again until the overlap is solved.

Automatic Satellite Programme Recording

This function allows you to automatically record a satellite programme which is timer-programmed on your external satellite receiver. Connect a satellite receiver to the recorder's AV2 (L-2) IN/DECODER connector and programme the timer on the satellite receiver. The recorder starts or stops recording by the signals input from the satellite receiver. After recording, the recorder's power shuts off automatically.

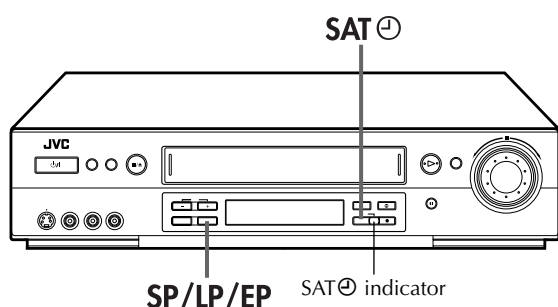

ATTENTION

- Be sure not to turn on the satellite receiver before the programme is executed; otherwise, the recorder will start recording when the satellite receiver's power is turned on.
- If you have connected another appliance other than a satellite receiver to the AV2 (L-2) IN/DECODER connector, be sure not to engage the Automatic Satellite Programme Recording mode; otherwise, the recorder will start recording when the connected appliance's power is turned on.
- Automatic Satellite Programme Recording and timer-recording cannot be done at the same time.

Before performing the following steps:

- Make sure the satellite receiver is connected to the recorder's AV2 (L-2) IN/DECODER connector. (☞ pg. 60, 61)
- Programme the timer on the satellite receiver.
- Insert a cassette with the safety tab in place.

1 Select the L-2 SELECT mode.

Set "L-2 SELECT" to "A/V" or "SAT" (☞ pg. 51).

- When you select "SAT", refer to "IMPORTANT" on page 60.

2 Set the tape speed.

Press SP/LP/EP (///).

- It is not possible to select EP mode if "COLOUR SYSTEM" is set to "MESECAM". (☞ pg. 67)

3 Engage the Automatic Satellite Programme Recording mode.

Press and hold SAT with a circle and a dot symbol for about 2 seconds. The SAT with a circle and a dot symbol indicator lights up and the recorder turns off automatically.

NOTES:

- To disengage the Automatic Satellite Programme Recording mode, press SAT with a circle and a dot symbol. The SAT with a circle and a dot symbol indicator goes off.
- If the recorder's power is off, it is not possible to engage the Automatic Satellite Programme Recording mode.
- In step 3, if the SAT with a circle and a dot symbol indicator does not light but instead blinks quickly even though your satellite receiver's power is off, Automatic Satellite Programme Recording will not work properly with that satellite receiver*. If this is the case, perform "Express Timer Programming" (☞ pg. 32) to timer-record a satellite programme.
* Some satellite receivers output signals even if the power is off. Automatic Satellite Programme Recording is not possible with those satellite receivers.
- The SAT with a circle and a dot symbol indicator blinks while Automatic Satellite Programme Recording is in progress.
- For timer programming of the satellite receiver, refer to the instruction manual of the satellite receiver.
- Automatic Satellite Programme Recording is not possible if your satellite receiver does not have a timer.
- Pressing the recorder's STOP button while Automatic Satellite Programme Recording is in progress turns off the recorder's power and disengages the Automatic Satellite Programme Recording mode.
- If there are more than one satellite programmes you wish to record with Automatic Satellite Programme Recording, it is not possible to set different tape speeds for each programme.
- Depending on the type of satellite receiver, the recorder may not record a slight portion of the beginning of the programme or may record slightly longer than the actual length of the programme.
- If you engage the Automatic Satellite Programme Recording mode when the satellite receiver's power is on, the recorder will not start Automatic Satellite Programme Recording even though the SAT with a circle and a dot symbol indicator blinks. When the satellite receiver shuts off once and is turned back on again, the recorder starts recording.
- You can also record a programme from your cable system in the same way if the system has a timer.
- The B.E.S.T. system (☞ pg. 29) does not work while Automatic Satellite Programme Recording is in progress.
- Just Clock (☞ pg. 76) does not work when the Automatic Satellite Programme Recording mode is engaged.
- When the Automatic Satellite Programme Recording mode is engaged, or the recorder's power is turned off after Automatic Satellite Programme Recording is finished, the recorder will not enter the Timer mode even though "AUTO TIMER" is set to "ON" (☞ pg. 65).

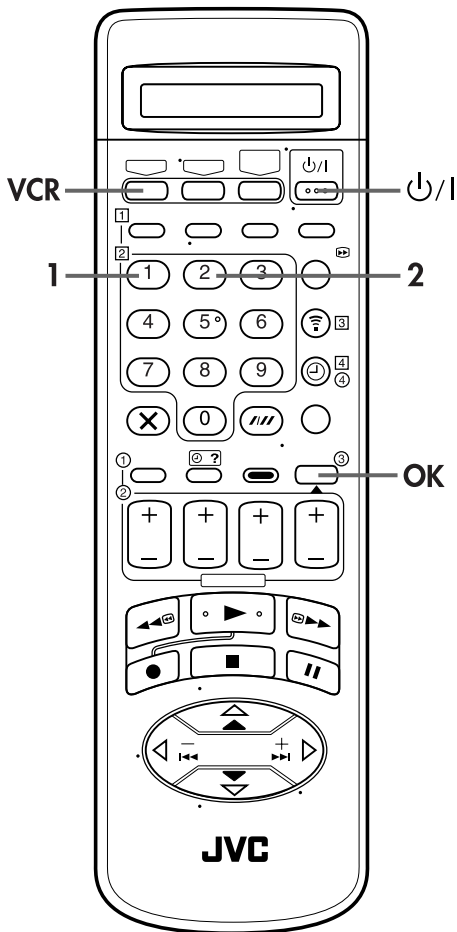

Remote A/B Code Switching

The remote control is capable of controlling two JVC video recorders independently; one set to respond to the remote control's A code control signals and another set to respond to B code control signals. The remote control is preset to send A code signals because your video recorder is initially set to respond to A code signals. You can easily modify your video recorder to respond to B code signals.

1 Remove the power supply.

Unplug the end of the mains power cord from the mains outlet.

2 Set the remote control code.

Press and hold **VCR** on the remote control for over 2 seconds, press the **number key "2"** and then press **OK**.

3 Re-supply the power.

Plug the end of the mains power cord into a mains outlet.

4 Turn on the recorder.

Press **power** on the remote control. The recorder will now only respond to B code signals.

NOTE:

To set the recorder back to respond to A code signals, repeat the same procedure as shown above, but in step 2, press the **number key "1"** instead of "2".

TV Multi-Brand Remote Control

Your remote control can operate the basic functions of your TV set. In addition to JVC TVs, other manufacturer's TVs can also be controlled.

Before performing the following steps:

Turn off the TV using its remote control.

1 Set the TV brand code.

Refer to the chart below. Press and hold **TV** on the recorder's remote control for over 2 seconds, enter your TV's brand code using the **number keys**, then press **OK**. Press $\psi/1$ on the recorder's remote control to turn on the TV and try operations (see step 2).

- Once you have set the remote control to operate the TV, you do not have to repeat this step until you replace your remote control's batteries.
- JVC or SAMSUNG has more than one code. If the TV does not function with one code, try entering another.

2 Operate the TV.

First, press **TV** to set the remote control to TV mode, then press the corresponding button: $\psi/1$, **TV/VCR**, **TV PR +/-**, **TV** \triangle +/- (Volume), Mute (TV Muting), **number keys**.

- For some brands of TV, you must press **OK** after having pressed the **number keys**.

IMPORTANT

Although the provided remote control unit is compatible with JVC televisions, as well as many other models, it may not work with your TV, or in some instances, may have limited function capability.

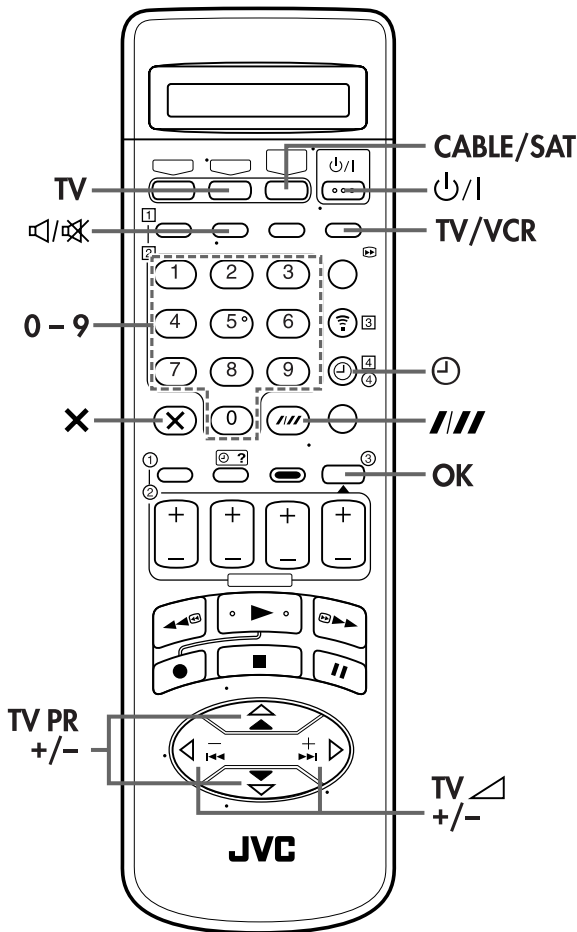

Control Your TV Using Additional Buttons

Use the **number keys**, and the **///** button, **X** button or \odot button to select the TV's channel.

- With televisions under Code 01, 02, 07, 10, 11, 14, 20, 23, 24, 25, 27, 33 or 35, the **///** button corresponds to the 1-digit/2-digit entry switching button (often labelled -/-) of your TV's remote control.
- With televisions under Code 01, 28, 29 or 34, the **X** button corresponds to the 10 + button, and the \odot button corresponds to the 20 + button of your TV's remote control.

NOTE:

The way these buttons are used is determined by your TV. Use these buttons as instructed for your TV's remote control.

BRAND NAME	CODE
JVC	01, 23, 24, 25
BLAUPUNKT	19
BRANDT	26
FERGUSON	27
FINLUX	30
FUNAI	32
LG/GOLDSTAR	18
GRAETZ	28
GRUNDIG	19
HITACHI	10
ITT	28
LUXOR	28
MITSUBISHI	03
MIVAR	29
NEC	20
NOKIA	31
NORDMENDE	26
PANASONIC	11
PHILIPS	02
SABA	26
SALORA	28
SAMSUNG	02, 12, 33, 34, 35
SELECO	28
SHARP	06
SONY	07
TELEAVIA	26
TELEFUNKEN	26
THOMSON	26
TOSHIBA	14

Satellite Receiver Multi-Brand Remote Control

Your remote control can operate the basic functions of your satellite receiver set. In addition to JVC satellite receivers, other manufacturer's satellite receivers can also be controlled.

Before performing the following steps:

Turn off the satellite receiver using its remote control.

1 Set the satellite receiver brand code.

Refer to the chart in the right column. Press and hold **CABLE/SAT** on the recorder's remote control for over 2 seconds, enter your satellite receiver's brand code using the **number keys**, then press **OK**.

Press $\psi/1$ on the recorder's remote control to turn on the satellite receiver and try operations (see step 2).

- Once you have set the remote control to operate the satellite receiver, you do not have to repeat this step until you replace your remote control's batteries.
- Some brands of satellite receiver have more than one code. If the satellite receiver does not function with one code, try entering another.

2 Operate the satellite receiver.

First, press **CABLE/SAT** to set the remote control to satellite receiver mode, then press the corresponding button: $\psi/1$, **TV PR +/-**, **number keys**.

- For some brands of satellite receiver, you must press **////** after having pressed the **number keys**.
- The **number keys** may not function with some satellite receivers.

IMPORTANT

Although the provided remote control unit is compatible with JVC satellite receivers, as well as many other models, it may not work with your satellite receiver, or in some instances, may have limited function capability.

BRAND NAME	CODE
JVC	73
AMSTRAD	60, 61, 62, 63, 92
CANAL SATELLITE	81
CANAL +	81
D-BOX	85
ECHOSTAR	78, 79, 80
ECHOSTAR (VIA DIGITAL)	82
FINLUX	68
FORCE	89
GALAXIS	88
GRUNDIG	64, 65
HIRSCHMANN	64, 78
ITT NOKIA	68
JERROLD	75
KATHREIN	70, 71
LUXOR	68
MASCOM	93
MASPRO	70
NOKIA	87
PACE	65, 67, 74, 86, 92
PANASONIC	74
PHILIPS	66, 84
RFT	69
SAGEM	83
SALORA	68
SIEMENS	64
SKYMASTER	69
TPS	83
TRIAx	91
WISI	64

Navigation

When you record a TV programme with this recorder, the recorder automatically stores in its memory the recording start time, date, channel information, etc. If the tape is recorded on this recorder for the first time, new tape number and the recording date are also registered. On the tape only the tape number information is recorded.

Turn on the TV and select the video channel (or AV mode).

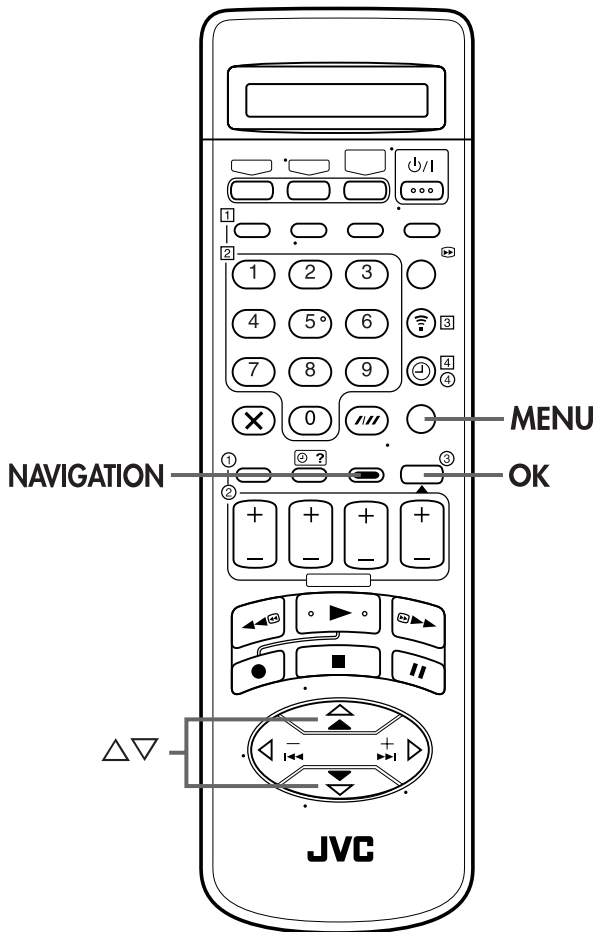

Navigation Playback

This function is useful when you wish to quickly find out what programmes you have recorded on a tape with this recorder. This function allows you to select a programme to watch, and then automatically searches for the start of the programme.

1 Load a recorded cassette.

Insert a cassette recorded on this recorder.

- While “---” is blinking on the front display panel, the tape will run for a few seconds to search for the tape number.

2 Access the title screen.

Press **NAVIGATION**.

- After pressing **NAVIGATION**, it may take a few seconds to access the title screen while the recorder searches for the programme information.
- If there is no cassette loaded, “FIND TITLE” screen appears. (see pg. 46)

3 Select a programme.

Press $\Delta \nabla$ to move the highlight bar (pointer) to the programme you want to watch.

0013	FOOTBALL 98	1/3
22:00	BLANK	1.25 (SP)
20:00	26.02.99	BBC1
20:00	27.02.99	BBC2
BLANK	0:30 (SP)	
F 21:00	28.02.99	L-1
22:15	28.02.99	PR.07
8:15	15.01.00	BBC1
21:00 → 22:30	1.30 (SP)	
WORLD CUP 98	SPORTS	
[NAVIGATION] : EXIT		

4 Start playback.

Press **OK**. Playback begins automatically after the selected programme is located.

Check Memory

You can check the amount of recorded information in the memory.

1 Access the Main Menu screen.

Press **MENU**.

2 Access the Video Navigation screen.

Press $\Delta \nabla$ to move the highlight bar (pointer) to “VIDEO NAVIGATION”, then press **OK** or \triangleright .

MAIN MENU	
MODE SET	
AUTO CH SET	
MANUAL CH SET	
OUTPUT/INPUT SET	
INITIAL SET	
REC LEVEL CTL	
F VIDEO NAVIGATION	
[MENU] : EXIT	

3 Check the memory.

Press $\Delta \nabla$ to move the highlight bar (pointer) to "CHECK MEMORY", then press **OK**.

- The CHECK MEMORY screen will appear.

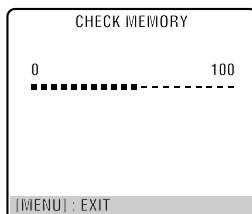

4 Return to the normal screen.

Press **MENU**.

Turn Off Navigation

If you do not want to record information on the programmes, set "NAVIGATION" to "OFF".

Perform steps 1 to 2 of "Check Memory" on page 40 before continuing.

1 Turn off Navigation.

Press $\Delta \nabla$ to move the highlight bar (pointer) to "NAVIGATION", then press **OK** or \triangleright to set to "OFF".



2 Return to the normal screen.

Press **MENU**.

Video Navigation Title Screen

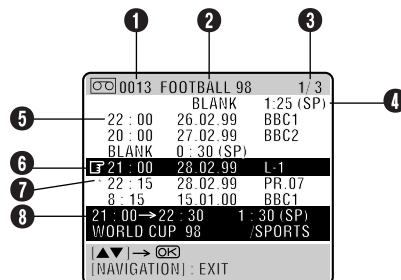

- 1 Tape number
- 2 Tape title
If there is no tape title entered, the earliest recording date will be displayed.
- 3 Current page number/total page number
- 4 Largest blank space on the tape
(Calculated remaining time based on the current tape speed (SP, LP or EP) selected on the recorder)
- 5 Programme information
(Recording start time, date and channel number)
- 6 Currently selected programme
- 7 Current tape position
"*" is displayed if the currently selected programme and the current tape position are different while tape is not running.
- 8 Detailed information of currently selected programme
(Recording start time, end time, recording length, recording speed, programme title and category)
If there are no title and category entered, "TITLE" and "CATEGORY" will be displayed.

NOTES:

- Video Navigation is possible with the cassettes recorded with this recorder only.
- To record the date and time as the programme title in this recorder's memory, make sure the recorder's clock is set correctly before recording.
- To record the programme information in this recorder's memory, you must continue to record each programme for over the minimum recording time; 8 minutes for the SP mode, 15 minutes for the LP mode or 23 minutes for the EP mode.
- Video Navigation may not work properly depending on the tape being used.
- If the recorder finds two tape numbers in one tape while playing back or searching for the beginning of a programme, then when you remove the tape, the tape will be assigned just one number (smaller number).
- The programme information is stored in this recorder's memory. If the memory in this recorder should ever be damaged and the programme information lost, it is impossible to restore that information.
- After recording a tape with this recorder, write the tape number on a label and affix the label to the cassette in order to allow you to find the tape by its number.

Find Blank Space

This function is useful for finding out the blank space on each cassette and recording a new programme there.

Perform steps 1 to 2 of "Check Memory" on page 40 before continuing.

1 Access the Find Blank Space screen.

Press Δ/∇ to move the highlight bar (pointer) to "FIND BLANK SPACE", then press **OK**.

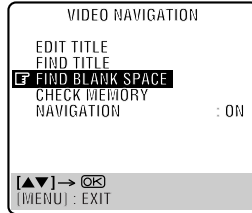

2 Select the tape number.

Press Δ/∇ to move the highlight bar (pointer) to the tape number on which you want to record a programme, then press **OK**.

- The calculated blank space is based on the current tape speed (SP, LP or EP) selected on the recorder.
- If the selected cassette has already been loaded, the recorder searches the beginning of the blank space and goes into the stop mode automatically.



3 Load a cassette.

Insert the cassette whose number is displayed on the screen.

- The recorder searches the beginning of the blank space and goes into the stop mode automatically.



NOTE:

The recorder may not go into the stop mode right on the beginning of the selected blank space.

Edit Title

You can edit the tape title and the programme titles as you like. You can also select the category for each programme. In short, you can use the Video Navigation function to create your own video tape library.

Turn on the TV and select the video channel (or AV mode).

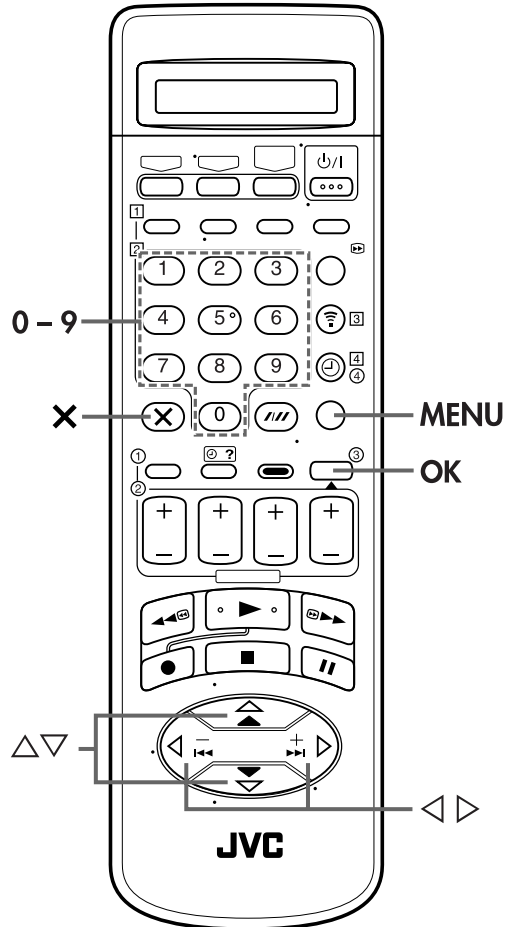

Edit Tape Title

1 Access the Main Menu screen.

Press MENU.

2 Access the Video Navigation screen.

Press $\Delta \nabla$ to move the highlight bar (pointer) to "VIDEO NAVIGATION", then press OK or \triangleright .

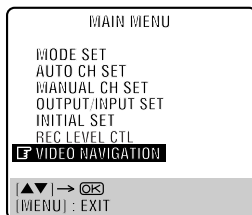

3 Access the Edit Title screen.

Press $\Delta \nabla$ to move the highlight bar (pointer) to "EDIT TITLE", then press OK or \triangleright .

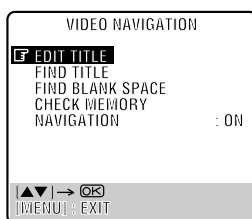

4 Select the tape number.

Press $\Delta \nabla$ to move the highlight bar (pointer) to the tape number whose title you want to edit, then press OK or \triangleright .

- The "*" mark indicates the tape number of the cassette that is currently in the recorder.

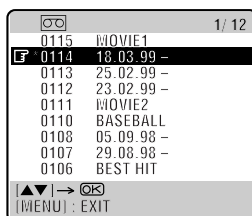

5 Select the tape title.

Press $\Delta \nabla$ to move the highlight bar (pointer) to the tape number, then press OK or \triangleright . The tape title begins blinking.

- The "*" mark indicates the current position on the tape.

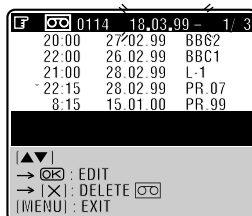

6 Enter the tape title.

Press the **number keys** and \triangleright to enter characters, then press OK. For details, refer to "Entering Character" below.

7 Return to the normal screen.

Press MENU.

Entering Character

Press the appropriate **number key**, then press \triangleright to enter each character.

Refer to the example below.

(Example) Enter "JVC NEWS"

- Press 5 (JKL) once to enter "J", then press \triangleright .
- Press 8 (TUV) three times to enter "V", then press \triangleright .
- Press 2 (ABC) three times to enter "C", then press \triangleright .
- Press 0 () twice to enter " " (space), then press \triangleright .
- Press 6 (MNO) twice to enter "N", then press \triangleright .
- Press 3 (DEF) twice to enter "E", then press \triangleright .
- Press 9 (WXYZ) once to enter "W", then press \triangleright .
- Press 7 (PQRS) four times to enter "S", then press \triangleright .

NUMBER KEY	CHARACTER
1	., / - + * () 1
2	A B C 2 Ä Å Á Â Ã Ä Å Æ
3	D E F 3 È É Ê Ë
4	G H I 4 Î Ï Í
5	J K L 5
6	M N O 6 Ö Õ Ò Ó Ô Õ Ø Ñ
7	P Q R S 7
8	T U V 8 Ü Ù Ú Û Ü
9	W X Y Z 9
0	0 _

NOTES:

- If you make a mistake, press $\triangleleft \triangleright$ to select the character, then enter the correct character.
- If you want to delete a character, press $\triangleleft \triangleright$ to select the character, then press X.

Edit Programme Title and Category

Perform steps 1 to 4 of "Edit Tape Title" on page 43 before continuing.

1 Select the programme.

Press Δ/∇ to move the highlight bar (pointer) to the programme you want to edit, then press **OK** or \triangleright . The "TITLE" display begins blinking.

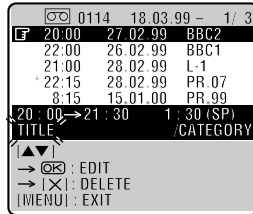

2 Enter the programme title.

Press the **number keys** and \triangleright to enter characters, then press **OK**. For details, refer to "Entering Character" on page 43.

3 Select the category.

Press Δ/∇ to select the category you want, then press **OK** or \triangleright .



4 Return to the normal screen.

Press **MENU**.

Choice of Category

- CATEGORY Δ
- Δ ∇
- MOVIE
- Δ ∇
- SPORTS
- Δ ∇
- SPECIAL
- Δ ∇
- SERIES
- Δ ∇
- SHOW
- Δ ∇
- MUSIC
- Δ ∇
- CHILDREN
- Δ ∇
- NEWS
- Δ ∇
- OTHERS ∇



Delete Tape Data

Perform steps 1 to 4 of "Edit Tape Title" on page 43 before continuing.

1 Select the tape title.

Press $\Delta\nabla$ to move the highlight bar (pointer) to the tape number you want to delete, then press X.

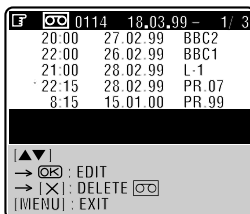

2 Delete the tape data.

Press $\Delta\nabla$ to move the highlight bar (pointer) to "YES", then press OK or \triangleright .



3 Return to the normal screen.

Press MENU.

Delete Programme Data

Perform steps 1 to 4 of "Edit Tape Title" on page 43 before continuing.

1 Select the programme.

Press $\Delta\nabla$ to move the highlight bar (pointer) to the programme you want to delete, then press X.

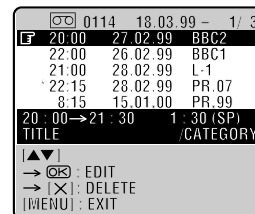

2 Delete the programme data.

Press $\Delta\nabla$ to move the highlight bar (pointer) to "YES", then press OK or \triangleright .

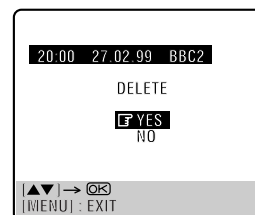

3 Return to the normal screen.

Press MENU.

NOTES:

- When you delete data, only the tape and/or programme information is deleted from the recorder's memory. The actual recording on the tape is not erased.
- If the recorder's memory becomes full, the recorder cannot register any more information. Delete any unnecessary data of tape or programme from the recorder's memory.

Find Title

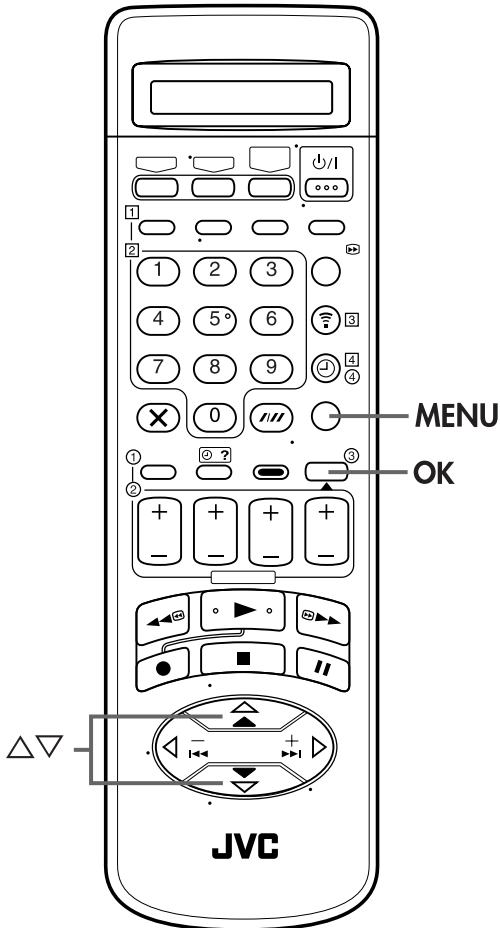

Sort By Tape Number

This function is useful for finding out the programme you want to playback in the order sorted by tape number.

1 Access the Main Menu screen.

Press **MENU**.

2 Access the Video Navigation screen.

Press $\Delta\nabla$ to move the highlight bar (pointer) to "VIDEO NAVIGATION", then press **OK** or \triangleright .

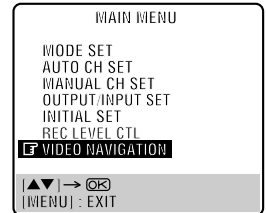

3 Access the Find Title screen.

Press $\Delta\nabla$ to move the highlight bar (pointer) to "FIND TITLE", then press **OK** or \triangleright .

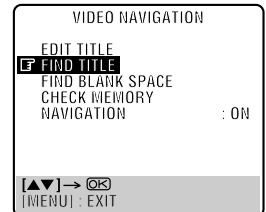

4 Access the Tape No. screen.

Press $\Delta\nabla$ to move the highlight bar (pointer) to "BY TAPE NO.", then press **OK** or \triangleright .



5 Select the programme.

Press $\Delta\nabla$ to move the highlight bar (pointer) to the programme you want to play back, then press **OK**.

- If the selected cassette has already been loaded, playback begins automatically after the selected programme is located.

			1/100
0999	BBC2	1900	28.12.99
0999	F1	BRAZIL	28.12.99
0999	007	GOLDE	25.12.99
0999	BBC1	2100	30.11.99
0998	ZDF	2100	28.11.99
F	0998	PR99 1000	01.01.00
0997	ARSENAL	V	25.11.99
0996	BBC2	2300	24.11.99
0996	RA11	915	26.12.99

[\leftarrow]: PAGE (MENU) : EXIT
[$\Delta\nabla$]: OK : SEARCH

6 Load a cassette.

Insert the cassette whose number is displayed on the screen.

- Playback begins automatically after the selected programme is located.



Sort By Date

This function is useful for finding out the programme you want to play back in the order sorted by date.

Perform steps 1 to 3 of "Sort By Tape Number" on page 46 before continuing.

1 Access the Date screen.

Press $\Delta\nabla$ to move the highlight bar (pointer) to "BY DATE", then press **OK** or \triangleright .



2 Select the programme.

Press $\Delta\nabla$ to move the highlight bar (pointer) to the programme you want to play back, then press **OK**.

- If the selected cassette has already been loaded, playback begins automatically after the selected programme is located.

			1/100
0997	JAPAN	VS	14.02.00
0993	LOST WORL		02.01.00
F	0998	PR99 1000	01.01.00
0999	FOOTBALL		28.12.99
0999	F1	BRASIL	28.12.99
0996	RA11	2000	26.12.99
0999	007	GOLDE	25.12.99
0993	CNN	115	25.12.99
0999	BBC1	2000	30.11.99

[\leftarrow]: PAGE (MENU) : EXIT
[$\Delta\nabla$]: OK : SEARCH

3 Load a cassette.

Insert the cassette whose number is displayed on the screen.

- Playback begins automatically after the selected programme is located.



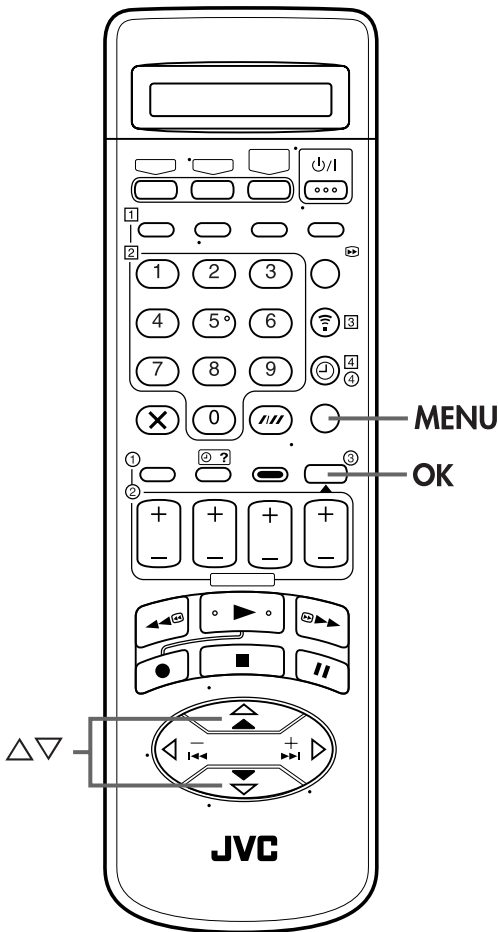

2 Select the category.

Press $\Delta \nabla$ to move the highlight bar (pointer) to the category you want to watch, then press **OK**.

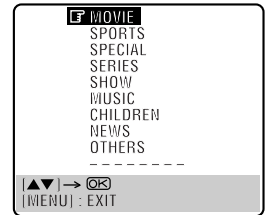

3 Select the programme.

Press $\Delta \nabla$ to move the highlight bar (pointer) to the programme you want to play back, then press **OK**.

- If the selected cassette has already been loaded, playback begins automatically after the selected programme is located.

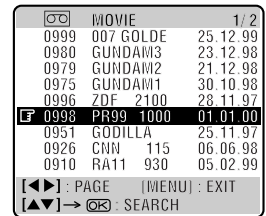

4 Load a cassette.

Insert the cassette whose number is displayed on the screen.

- Playback begins automatically after the selected programme is located.



Sort By Category

This function is useful for finding out the programme you want to play back in the order sorted by category.

Perform steps 1 to 3 of "Sort By Tape Number" on page 46 before continuing.

1 Access the Category screen.

Press $\Delta \nabla$ to move the highlight bar (pointer) to "BY CATEGORY", then press **OK** or \triangleright .



Edit From A Camcorder

You can use a camcorder as the source player and your recorder as the recording deck.

1 Make connections.

- 1 If the camcorder has no S-VIDEO output connector ...
... connect the camcorder's AUDIO OUT and VIDEO OUT connectors to the recorder's front panel AUDIO and VIDEO input connectors.
 - 2 If the camcorder has an S-VIDEO output connector ...
... connect the camcorder's AUDIO OUT and S-VIDEO OUT connectors to the recorder's front panel AUDIO and S-VIDEO input connectors.
- When using a monaural camcorder, connect its AUDIO OUT connector to the AUDIO L input connector on your recorder.
 - When a Master Edit Control-equipped JVC camcorder is used, the camcorder is capable of controlling the recorder. Refer to the camcorder's instruction manual for operating procedure.

2 Set the recorder's input mode.

Press **AUX** (number key "0") and/or **PR** to select "F-1" for the AUDIO and VIDEO input connectors, or "S-1" for the AUDIO and S-VIDEO input connectors, depending on the connectors being used.

3 Set the edit mode.

See "PICTURE CONTROL" on page 65.

4 Start the camcorder.

Engage the Play mode of the camcorder.

5 Start the recorder.

Engage the Record mode of the recorder.

NOTES:

- All necessary cables can be obtained from your dealer.
- When you select "EDIT" to dub tapes in step 3, be sure to select "AUTO" (or "NORM" when "B.E.S.T." is set to "OFF") after you finish dubbing the tapes.

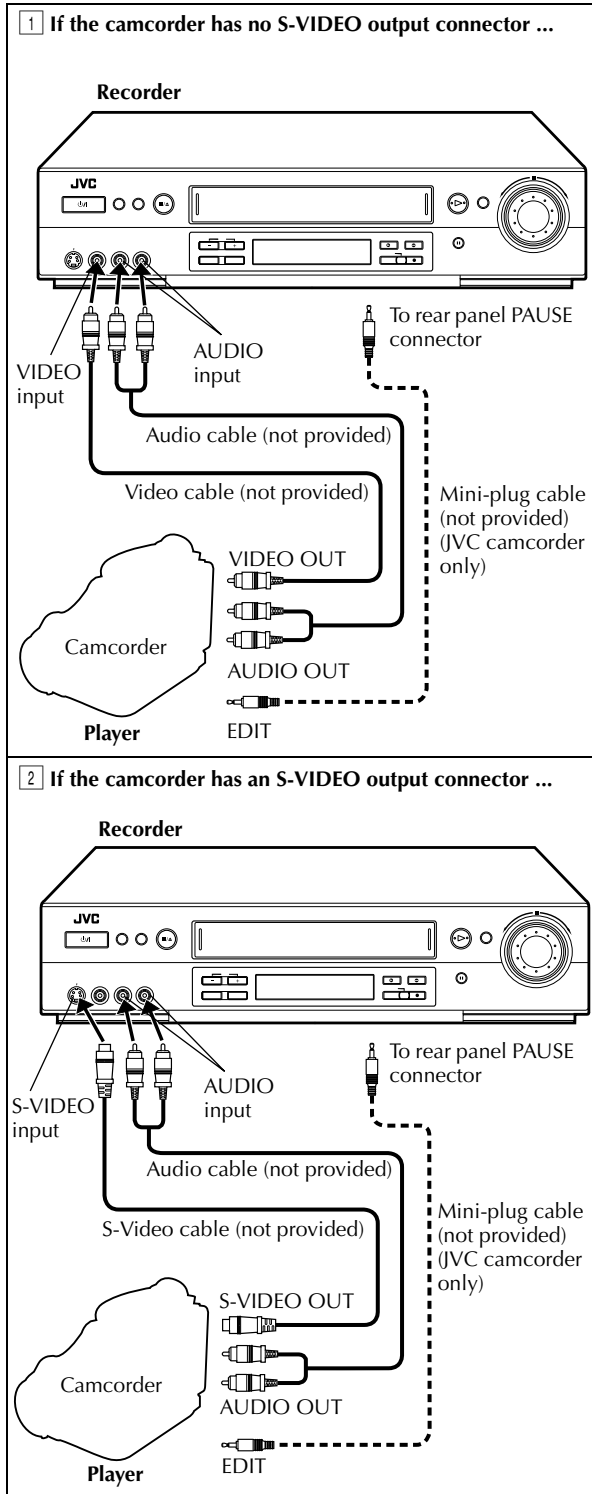

Output/Input Set

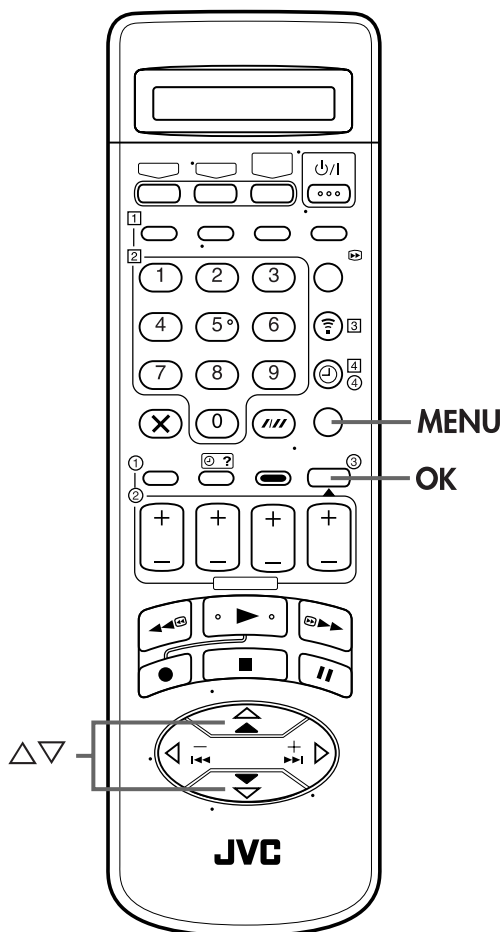

L-1 OUTPUT and L-1 INPUT Setting

The AV1 (L-1) IN/OUT connector accepts and delivers either a composite signal (regular video signal) or a Y/C signal (a signal in which the luminance and chrominance signals are separated). Set "L-1 OUTPUT" and "L-1 INPUT" to the appropriate mode depending on the type of appliance connected to the recorder's AV1 (L-1) IN/OUT connector.

1 Access the Main Menu screen.

Press **MENU**.

2 Access the Output/Input Set screen.

Press $\Delta \nabla$ to move the highlight bar (pointer) to "OUTPUT/INPUT SET", then press **OK** or \triangleright .

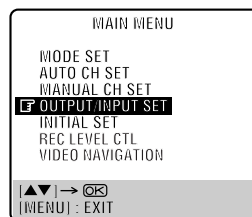

3 Select the output or input mode for the AV1 (L-1) IN/OUT connector.

Press $\Delta \nabla$ to move the highlight bar (pointer) to "L-1 OUTPUT" or "L-1 INPUT". Then, press **OK** or \triangleright to select the appropriate setting.

* The default setting is **bold** in the table below.

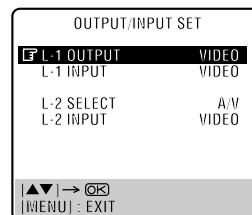

■ L-1 OUTPUT

VIDEO: If a connected appliance's input is compatible only with regular video signals, set to "VIDEO".

S-VIDEO: If a connected appliance's input is compatible with Y/C signals, set to "S-VIDEO". You can obtain high-quality S-VHS picture. (For connection, be sure to use a 21-pin SCART cable that is compatible with the Y/C signal.)

■ L-1 INPUT

VIDEO: If a connected appliance's output is compatible only with regular video signals, set to "VIDEO".

S-VIDEO: If a connected appliance's output is compatible with Y/C signals, set to "S-VIDEO". You can obtain high-quality S-VHS picture. (For connection, be sure to use a 21-pin SCART cable that is compatible with the Y/C signal.)

4 Return to the normal screen.

Press **MENU**.

NOTES:

- If "L-1 OUTPUT" is set to "S-VIDEO", it is impossible to set "L-1 INPUT" to "S-VIDEO".
- If "L-2 SELECT" is set to "DECODER", it is impossible to set "L-1 INPUT" to "S-VIDEO".

L-2 SELECT and L-2 INPUT Setting

The AV2 (L-2) IN/DECODER connector accepts either a composite signal (regular video signal) or a Y/C signal (a signal in which the luminance and chrominance signals are separated). Set "L-2 SELECT" to the appropriate mode depending on the type of appliance connected to the recorder's AV2 (L-2) IN/DECODER connector. Set "L-2 INPUT" to the appropriate mode depending on the output signals of the connected appliance.

Perform steps **1** and **2** of "L-1 OUTPUT and L-1 INPUT Setting" on page 50.

1 Select the input mode for the AV2 (L-2) IN/DECODER connector.

Press Δ/∇ to move the highlight bar (pointer) to "L-2 SELECT" or "L-2 INPUT".

Then, press **OK** or \triangleright to select the appropriate setting.

* The default setting is **bold** in the table below.

OUTPUT/INPUT SET	
L-1 OUTPUT	VIDEO
L-1 INPUT	VIDEO
L-2 SELECT	AV
L-2 INPUT	VIDEO

Δ/∇ | \rightarrow | **OK**
 [MENU] : EXIT

■ L-2 SELECT

- A/V:** To use this recorder as the recording deck with the player connected to the AV2 (L-2) IN/DECODER connector, or to use the satellite receiver connected to the AV2 (L-2) IN/DECODER connector.
- DECODER:** To use a decoder connected to the AV2 (L-2) IN/DECODER connector.
- SAT:** To view a satellite programme with the TV set while the recorder is turned off. (pg. 60)

■ L-2 INPUT

- VIDEO:** If a connected appliance's output is compatible only with regular video signals, set to "VIDEO".
- S-VIDEO:** If a connected appliance's output is compatible with Y/C signals, set to "S-VIDEO". You can obtain high-quality S-VHS picture. (For connection, be sure to use a 21-pin SCART cable that is compatible with the Y/C signal.)

NOTES:

- If you have a satellite receiver or a decoder connected to the AV2 (L-2) IN/DECODER connector, be sure to set "L-2 SELECT" back to appropriate mode after editing.
- If you are not connecting a satellite receiver or a decoder to the AV2 (L-2) IN/DECODER connector, leave "L-2 SELECT" set to "AV".
- The default setting is "AV"; if the recorder's memory backup has expired due to a power cut or because the AC was removed from the recorder, "AV" will be automatically selected when the power is restored to the recorder. If you are using a satellite receiver or a decoder, be sure to set "L-2 SELECT" back to appropriate mode.
- When "L-2 SELECT" is set to "SAT", "SAT" appears on TV screen or front display panel instead of "L-2" or "L2".
- If "L-2 SELECT" is set to "DECODER", it is impossible to set "L-2 INPUT" to "S-VIDEO".
- If "L-1 OUTPUT" is set to "S-VIDEO", it is impossible to set "L-2 SELECT" to "DECODER".

2 Return to the normal screen.

Press **MENU**.

Edit To Or From Another Video Recorder

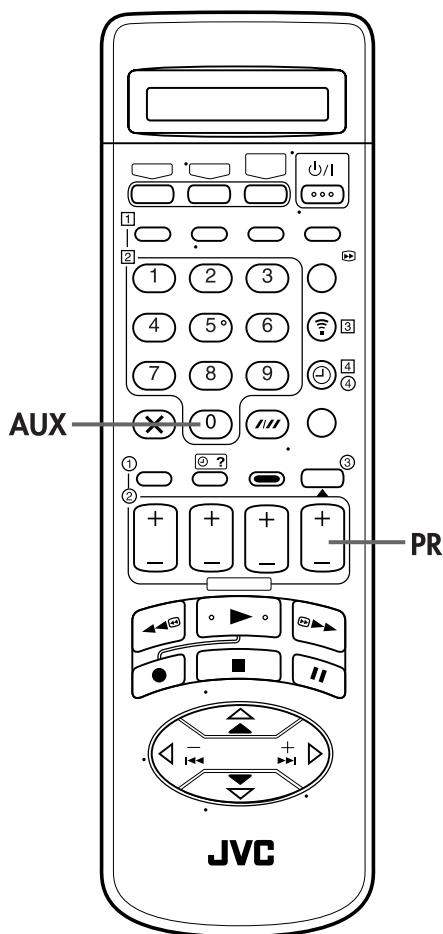

Advantages of S-VHS video recorders

You can edit from VHS to S-VHS, S-VHS to VHS, or, from S-VHS to S-VHS.

- From VHS to S-VHS: Record VHS playback signals in the S-VHS mode. Although the picture quality is inherently limited by that of the original, the edited tape has better picture quality than those made by VHS-to-VHS editing.
- From S-VHS to VHS: Because the picture quality of the source material is very high, the edited tape has better picture quality than those made by VHS-to-VHS editing.
- From S-VHS to S-VHS: All signals will be transferred with minimum degradation.

You can use your recorder as the source player or as the recording deck.

1 Make connections.

Connect the player's 21-pin SCART connector to the recorder's 21-pin SCART connector as illustrated on page 53.

- 1 When using your recorder as the source player ...
... connect its AV1 (L-1) IN/OUT connector to the recording deck.
- 2 When using your recorder as the recording deck ...
... connect its AV1 (L-1) IN/OUT or AV2 (L-2) IN/DECODER connector to the source player.
- 3 If another recorder is compatible with the Y/C signal ...
... connect your recorder's AV1 (L-1) IN/OUT connector to another recorder.

With 3 connection ...

- When using your recorder as the recording deck, set "L-1 INPUT" to "S-VIDEO" and "L-2 SELECT" to "A/V" (☞ pg. 50, 51).
- When using your recorder as the source player, set "L-1 OUTPUT" to "S-VIDEO" (☞ pg. 50).

2 Set the input mode of recording deck.

With this video recorder, press **AUX** (number key "0") and/or **PR** to select "L-1" for the AV1 (L-1) IN/OUT connector, or "L-2" for the AV2 (L-2) IN/DECODER connector, depending on the connector being used.

- When using another recorder as the recording deck, refer to its instruction manual.
- When using the AV2 (L-2) IN/DECODER connector, set "L-2 SELECT" to "A/V" (☞ pg. 51).

3 Set the edit mode.

See "PICTURE CONTROL" on page 65.

4 Start the source player.

Engage the Play mode of the source player.

5 Start the recording deck.

Engage the Record mode of the recording deck.

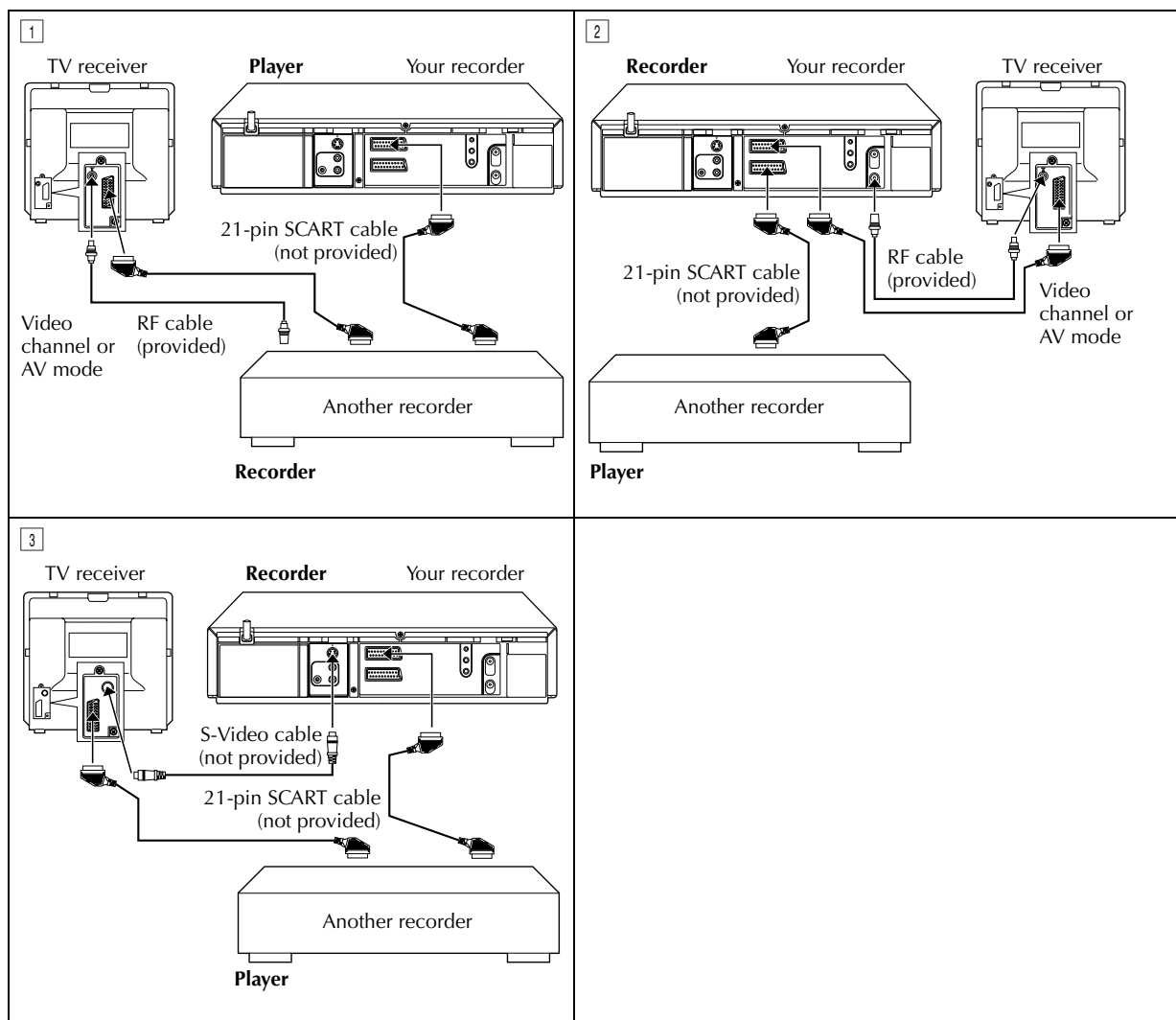

NOTES:

- All necessary cables can be obtained from your dealer.
- For Y/C signal input/output, be sure to use a 21-pin SCART cable that is compatible with the Y/C signal.
- When you select "EDIT" to dub tapes in step 3, be sure to select "AUTO" (or "NORM" when "B.E.S.T." is set to "OFF") after you finish dubbing the tapes.
- When you use this recorder as the source player for editing, be sure to set "O.S.D." to "OFF" before starting (☞ pg. 65).
- If you are using another recorder with S-Video and Audio input/output connectors, you can connect those connectors to this recorder's S-VIDEO and AUDIO input/output connectors.
 When using your recorder as the source player ...
 ... connect its rear panel S OUT and AUDIO OUT connectors to the recording deck's S-Video and Audio input connectors.
 When using your recorder as the recording deck ...
 ... connect its front panel S-VIDEO and AUDIO input connectors to the source player's S-Video and Audio output connectors. Then, set the recorder's input mode to "S-1".

Audio Dubbing

Audio Dubbing replaces the normal audio sound of a previously recorded tape with a new soundtrack.

ATTENTION:

Audio dubbing is not possible with a cassette recorded in EP mode.

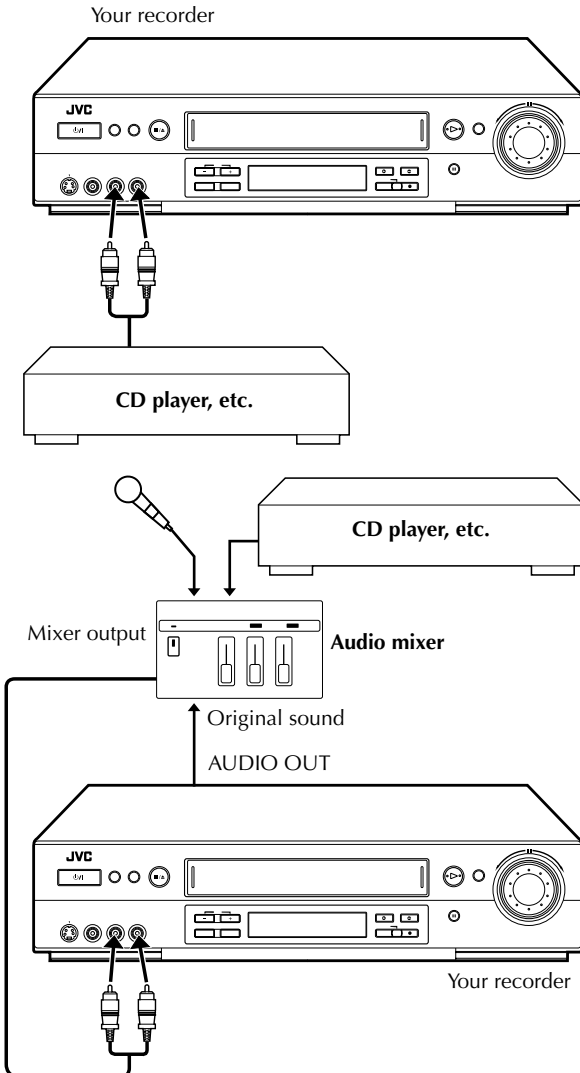
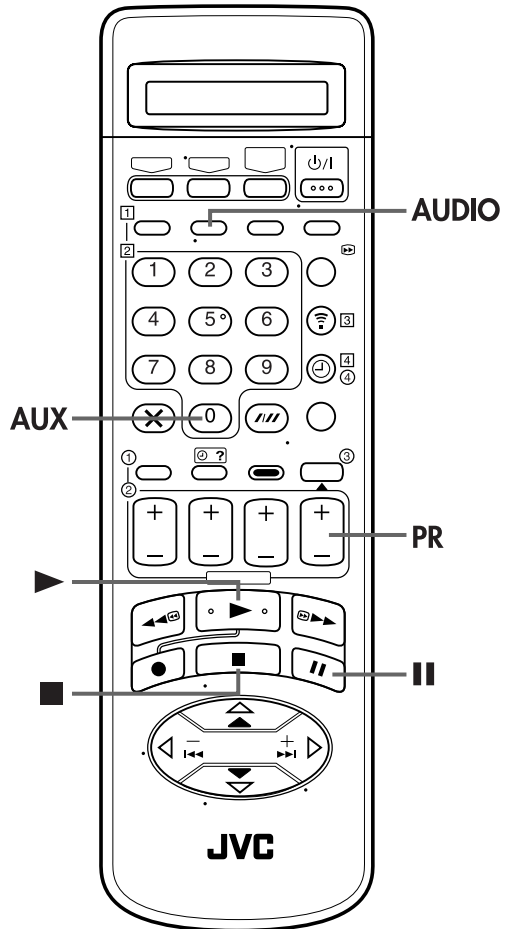
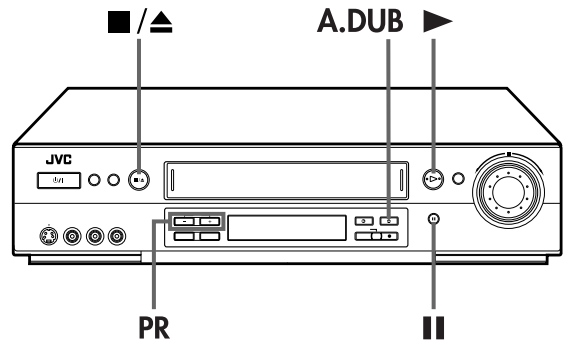
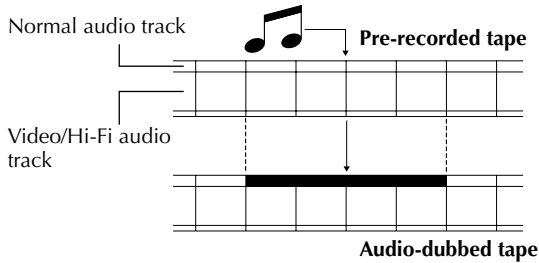

1 Make connections.

Connect an audio component to the AUDIO L + R input connectors on the recorder's front panel.

- When connecting a monaural audio component, use only the recorder's AUDIO L input connector.

2 Set the recorder's input mode.

Press **AUX** (number key "0") and/or **PR** to select "F-1" or "S-1".

3 Locate the start point.

Press **▶** to start playback of the tape in your recorder, and press **II** when you reach the point where you want to start dubbing.

4 Engage the Audio Dubbing mode.

Press **A.DUB**.

- Your recorder enters the Audio Dubbing Pause mode. ("◐" blinks, "▶" and "■" light up on the front display panel.)
- To perform Audio Dubbing with audio mixing, press **AUDIO** to select "◻ + ◻ (L+R)" at this point.

* Audio Dubbing with audio mixing is not possible if you are using a monaural audio component, or if you don't have an audio mixer.

5 Start dubbing.

Engage the audio component's Play mode, then press **▶** to start the tape in your recorder; Audio Dubbing begins at this point.

- "◐" blinks and "▶" is displayed on the front display panel.
- To stop dubbing temporarily, press **II**. Press **▶** to resume dubbing.

6 End Audio Dubbing.

Press **■** (or **■/▲**) to stop the tape in your recorder, and engage the audio component's Stop mode.

NOTES:

- When monitoring the sound during Audio Dubbing, the normal soundtrack is automatically selected. If you wish to hear the mixed sound (Hi-Fi + Normal soundtracks), press **AUDIO** to select "◻ + ◻ (L+R) + NORM" (☞ pg. 23).
- Audio Dubbing stops automatically when the counter reaches "0:00:00", and the recorder enters the Play mode. Check the counter reading before dubbing.
- Audio Dubbing is also possible using the rear panel AV1 (L-1) IN/OUT or AV2 (L-2) IN/DECODER connector. When using these 21-pin SCART connectors, be sure to select the correct input mode ("L-1" or "L-2") in step 2.
- Audio Dubbing is not possible with cassettes whose record safety tab has been removed.
- When playing back an audio-dubbed tape, press **AUDIO** to select the soundtrack you wish to hear. (☞ pg. 23)

Insert Editing

Insert Editing replaces part of the recorded scene with new material. Both the picture and Hi-Fi audio soundtrack are replaced with new ones, while the normal audio soundtrack remains unchanged. If you wish to change the normal audio track as well, use the Audio Dubbing function simultaneously. For Insert Editing, use your recorder as the recording deck.

ATTENTION:

Insert editing is not possible with a cassette recorded in EP mode.

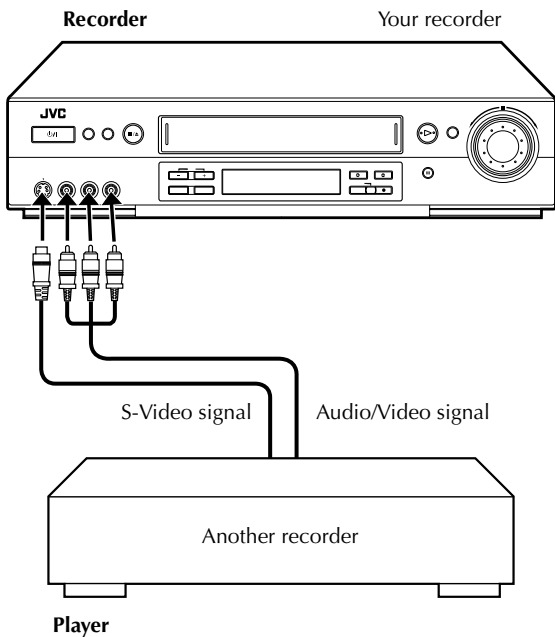
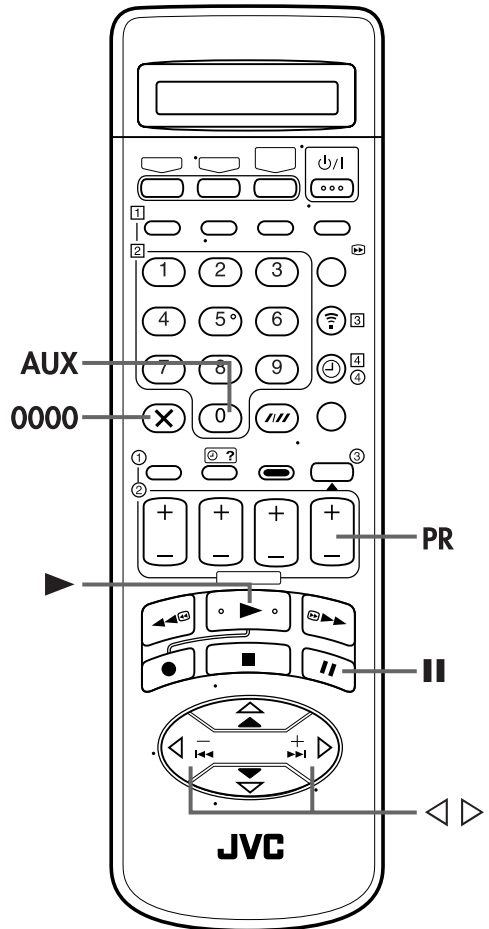
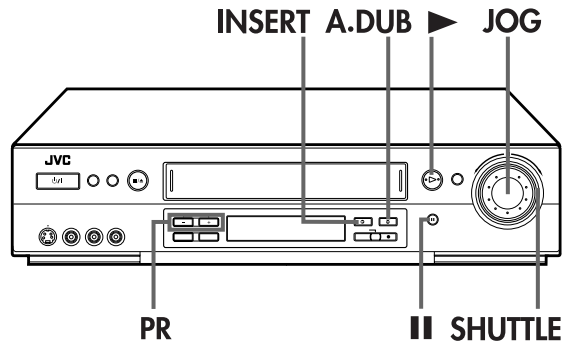
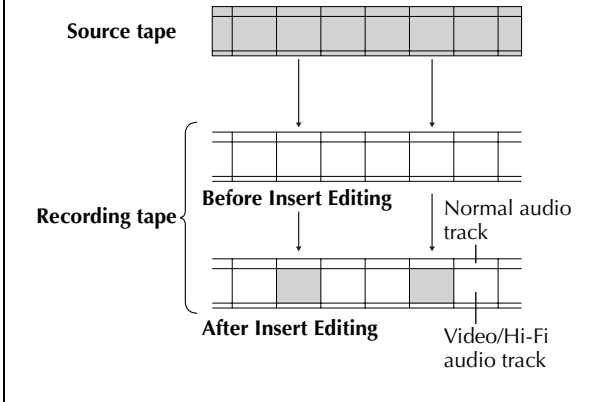

1 Make connections.

Connect the player's VIDEO OUT or S-VIDEO OUT and AUDIO OUT connectors to your recorder's VIDEO or S-VIDEO and AUDIO input connectors on the front panel.

2 Set the recorder's input mode.

Press **AUX** (number key "0") and/or **PR** to select "F-1" for the AUDIO and VIDEO input connectors or "S-1" for AUDIO and S-VIDEO input connectors.

3 Locate the end point.

Load the recording cassette into your recorder, and play it back to determine the edit-out point (the end of the segment to be replaced) using the **SHUTTLE** ring or the **JOG** dial, or pressing ◀▶ and **II**.

4 Reset the counter.

Press **0000**.

- The counter is reset to "0:00:00".

5 Locate the start point.

Determine the edit-in point (the beginning of the segment to be replaced) using the **SHUTTLE** ring or the **JOG** dial, or pressing ◀▶ and **II**.

- Be sure to engage the Still mode at the edit-in point.

6 Engage the Insert Editing mode.

Press **INSERT**.

- Your recorder enters the Insert Pause mode. ("○", "▶" and "⏏" light up on the front display panel.)
- The TV screen changes from the still picture to the input source you are going to record.

7 Start Editing.

Load the source cassette and play back the segment that is to be inserted. When you reach the start of the section of the source tape that you wish to insert, press ▶ to start the tape in your recorder; Insert Editing begins at this point.

- "○" and "▶" are displayed on the front display panel.

8 End Insert Editing.

At counter "0:00:00", Insert Editing will stop automatically while the tape continues running in the Play mode. If you wish to stop Insert Editing before the specified edit-out point, press **0000**.

AV Insert Editing

If you want to replace the picture, Hi-Fi audio soundtrack and normal audio soundtrack all at the same time ...
... In step 6, after you press **INSERT**, press **A.DUB** also. ("○" and "▶" blink and "⏏" lights up on the front display panel.)

NOTES:

- All necessary cables can be obtained from your dealer.
- Insert Editing is not possible with cassettes whose record safety tab has been removed.
- When Insert Editing is performed on a tape that has been recorded on another video recorder, the inserted portion may appear distorted.
- In Insert Editing, the recording speed (SP/LP) is determined by the previous recording to be replaced. If the previous recording's speed changes within a single edit, the inserted picture will be distorted at the switching point.
- A small portion of the recording which precedes an insert edit may become erased.
- Insert Editing is also possible using the rear panel AV1 (L-1) IN/OUT or AV2 (L-2) IN/DECODER connector. When using these 21-pin SCART connectors, be sure to select the correct input mode ("L-1" or "L-2") in step 2.

Synchro Editing

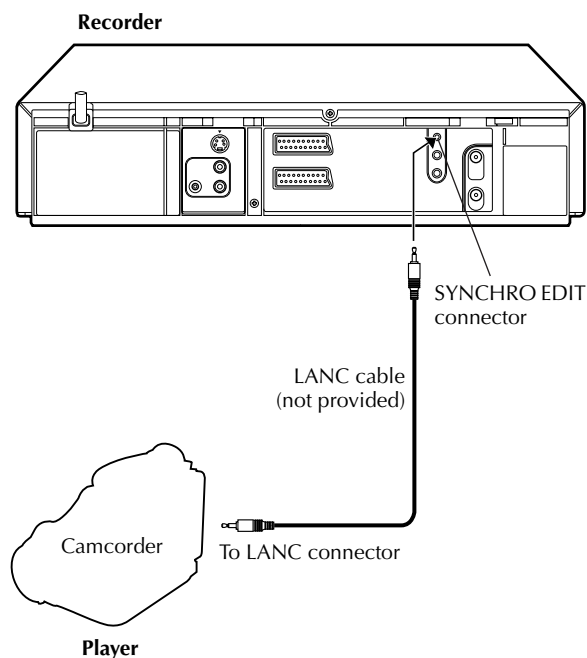
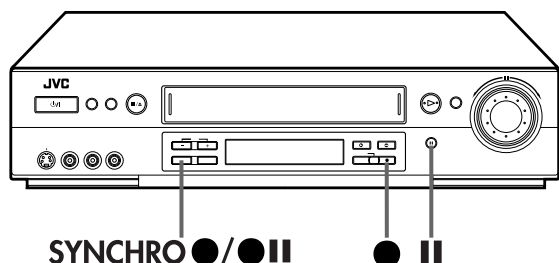

1 Make connections.

Connect your recorder to camcorder (see pg. 49), and connect your recorder's SYNCHRO EDIT connector to the camcorder's LANC connector.

2 Set the recorder's input mode.

Press **AUX** (number key "0") and/or **PR** to select "F-1" for the AUDIO and VIDEO input connectors, or "S-1" for the AUDIO and S-VIDEO input connectors, depending on the connectors being used.

3 Set the edit mode.

See "PICTURE CONTROL" on page 65.

4 Locate the start point.

Start playback of the tape in the camcorder, and pause playback when you find the point where you want to start editing. Press and hold **II** and press **●** on your recorder so that the recorder enters the Record-Pause mode.

5 Start Synchro Editing.

Press **SYNCHRO ●/●II**.

6 Pause Synchro Editing.

Press **SYNCHRO ●/●II** again.

- Repeat steps 4 – 6 as necessary.

NOTES:

- The Synchro Editing function may not work with the initial part of a camcorder tape.
- The Synchro Editing function cannot be used when using the J-LIP function. (Pressing **SYNCHRO ●/●II** cancels the J-LIP function.)
- The Synchro Editing function may not work properly with some type of camcorder.
- When you select "EDIT" to dub tapes in step 3, be sure to select "AUTO" (or "NORM" when "B.E.S.T." is set to "OFF") after you finish dubbing the tapes.

Information On J Terminal

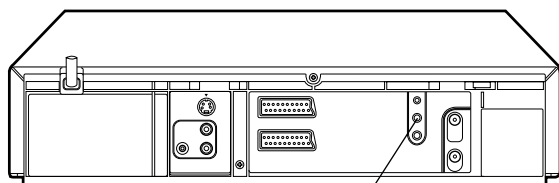

J terminal

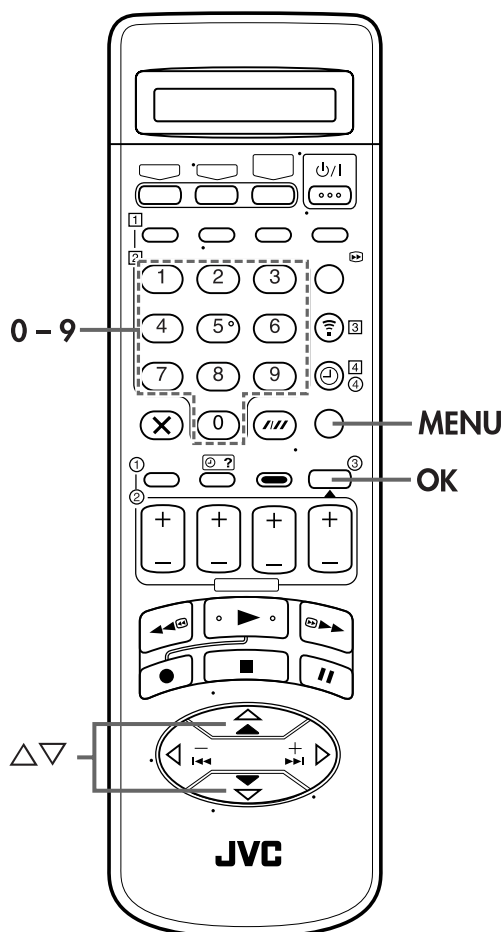

J Terminal [JLIP (Joint Level Interface Protocol) Connector]

The J terminal is used to connect the recorder to a personal computer or similar device to allow computerized control of the recorder during editing and certain other operations.

Examples:

With the optional JLIP VIDEO CAPTURE BOX GV-CB3E:

- Allows you to capture still images from the recorder into a personal computer.

For further details consult your nearest JVC dealer.

JLIP ID Number

Your recorder has its own JLIP ID number. This ID number must be unique when your recorder is connected to another device via its J terminal. The ID number is preset to "1" at the factory. You can change this number to any number between "1" and "99". If it is necessary to change the JLIP ID number, perform the following steps.

1 Access the Main Menu screen.

Press **MENU**.

2 Access the Initial Set screen.

Press $\Delta \nabla$ to move the highlight bar (pointer) to "INITIAL SET", then press **OK** or \triangleright .

3 Access the JLIP ID No. Set screen.

Press $\Delta \nabla$ to move the highlight bar (pointer) to "JLIP ID NO. SET", then press **OK** or \triangleright .



4 Set the JLIP ID number.

Press the **number keys** to enter the desired ID number, then press **OK**.

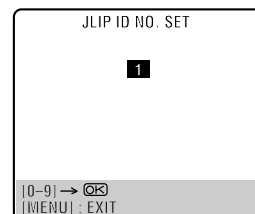

5 Return to the normal screen.

Press **MENU**.

Connecting To A Satellite Receiver

Simple Connections

This is an example of simple connection if your TV has one 21-pin AV input (SCART) connector.

Connect the satellite receiver to the AV2 (L-2) IN/DECODER connector, then connect the AV1 (L-1) IN/OUT connector to the TV's connector.

NOTES:

- Set "L-2 SELECT" to "AV" (☞ pg. 51).
- You can use Automatic Satellite Programme Recording function (☞ pg. 36) with this connection.
- To record a programme via the satellite receiver, select L-2 mode by pressing **AUX** (number key "0") and/or **PR** so that "L-2" appears on the front display panel.
- For details, refer to the instruction manual of the satellite receiver.

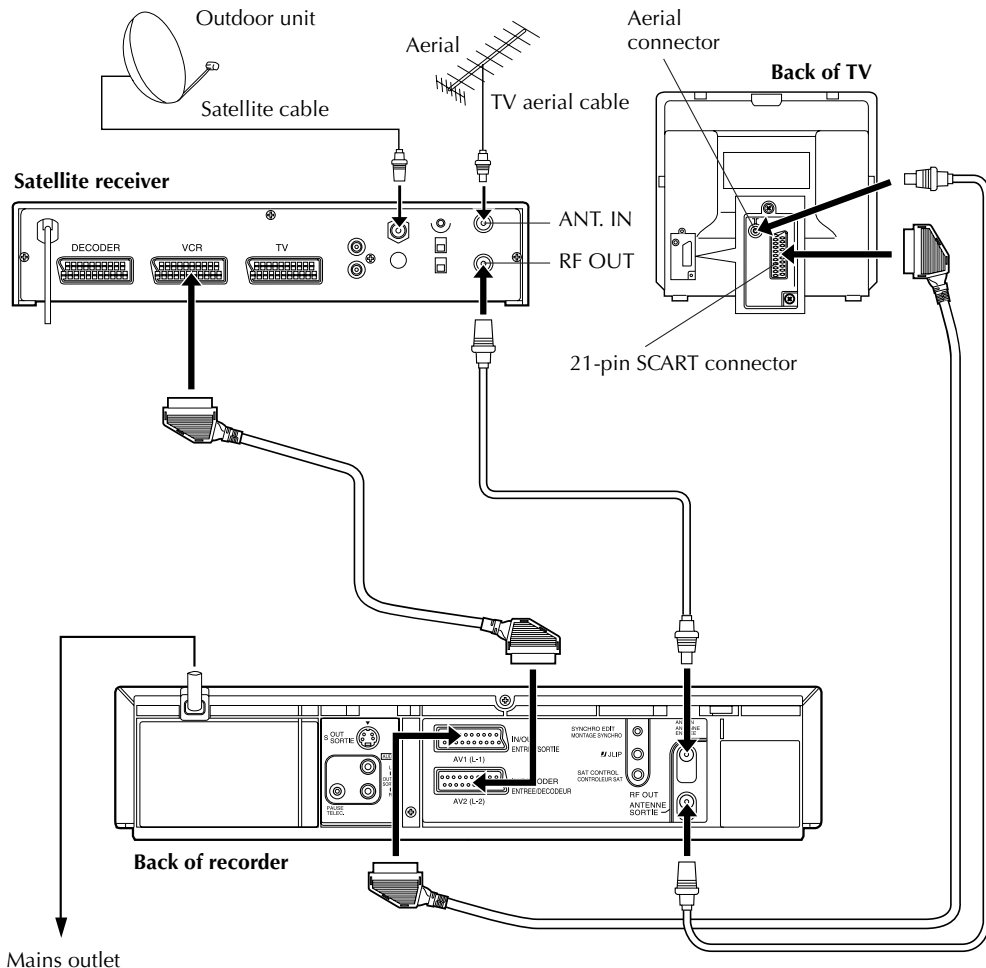

IMPORTANT

When you set "L-2 SELECT" to "SAT" (☞ pg. 51), it is possible to view a satellite broadcast with the TV set to its AV mode even if the recorder is turned off. When the recorder is in Stop mode or recording, press **TV/VCR** on the remote control to turn off the VCR indicator on the front display panel.

- If you turn on the recorder when the satellite receiver's power is off, nothing appears on the TV screen. In this case, turn on the satellite receiver, or set the TV to its TV mode, or press **TV/VCR** on the remote control to set the recorder to the video mode.

Perfect Connections

This is an example of recommended connection if your TV has two 21-pin AV input (SCART) connectors.

Connect the decoder to the satellite receiver's connector if you have a decoder, AV1 (L-1) IN/OUT connector to TV's connector, and AV2 (L-2) IN/DECODER connector to the satellite receiver's connector. Then connect the satellite receiver and TV.

NOTES:

- Set "L-2 SELECT" to "AV" (☞ pg. 51).
- You can use Automatic Satellite Programme Recording function (☞ pg. 36) with this connection.
- To record a programme via the satellite receiver, select L-2 mode by pressing **AUX** (number key "0") and/or **PR** so that "L-2" appears on the front display panel.
- To receive a scrambled broadcast, descramble the signal with the satellite receiver.
- For details, refer to the instruction manual of the satellite receiver and decoder.

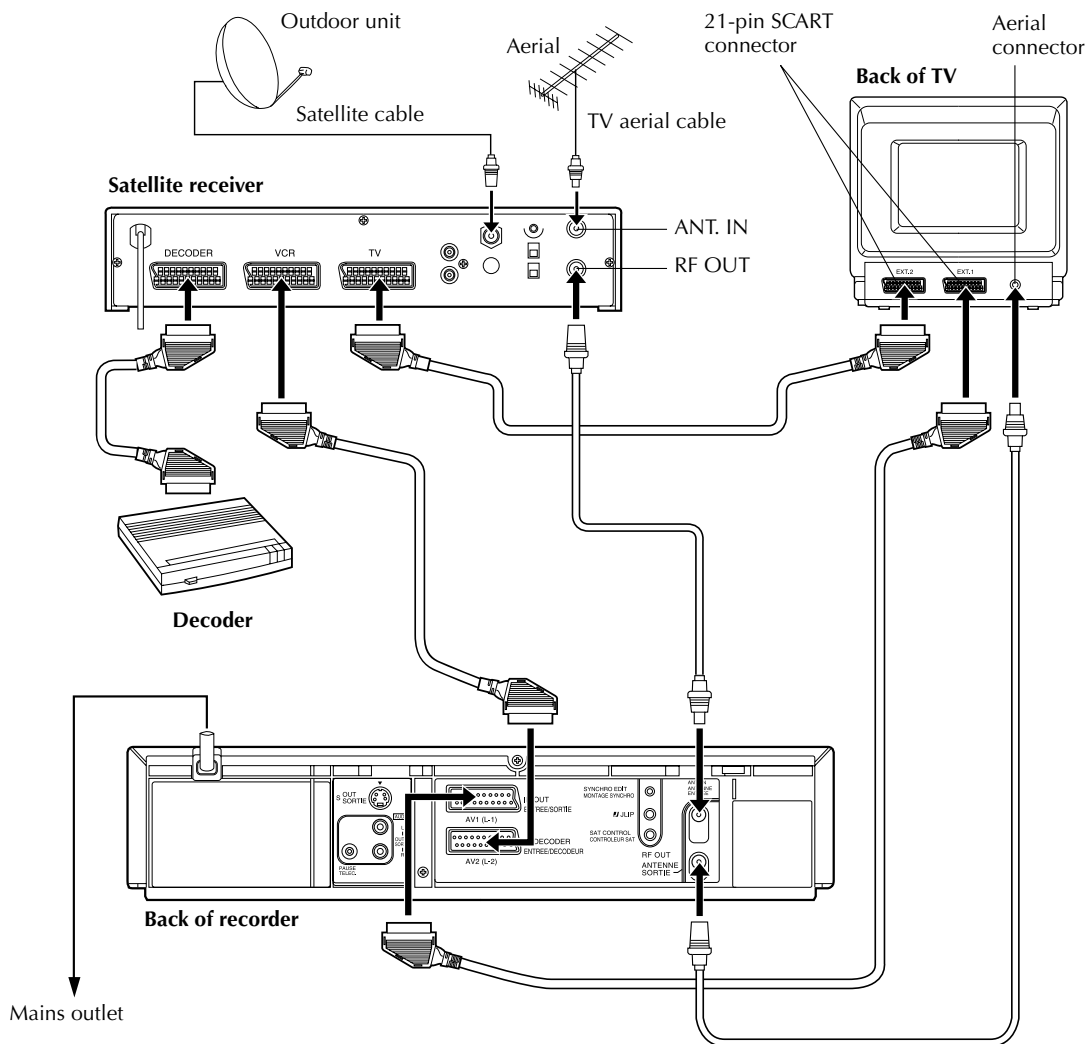

Connecting/Using A Decoder

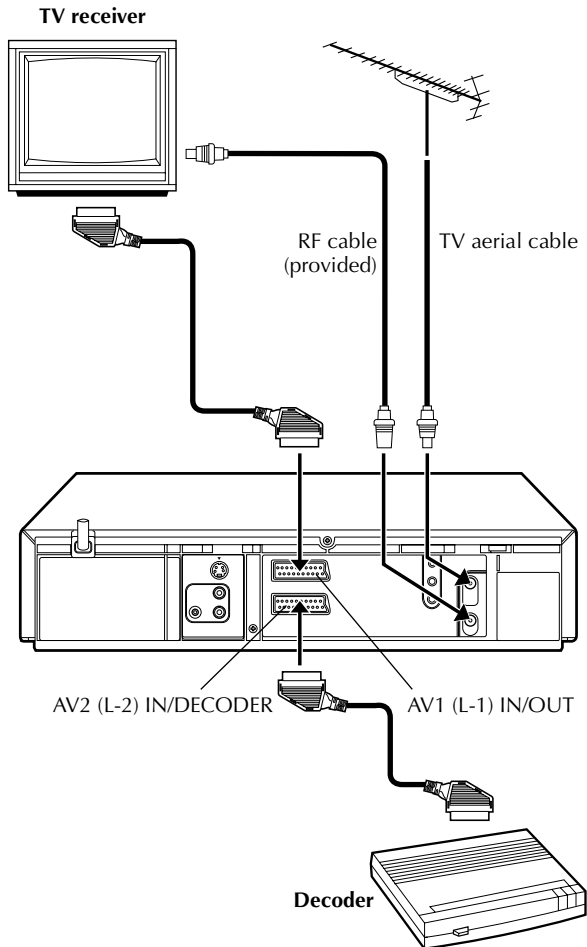

The AV2 (L-2) IN/DECODER connector can be used as an input connector for an external decoder (descrambler). Simply connect a decoder and you can enjoy the variety of programming that is available through scrambled channels.

1 Select the input mode.

Set "L-2 SELECT" to "DECODER". (☞ pg. 51)

2 Connect the decoder.

Connect your recorder's AV2 (L-2) IN/DECODER connector to the decoder's 21-pin SCART connector using a 21-pin SCART cable.

3 Set the tuner.

Perform the procedure as described in "When Receiving A Scrambled Broadcast" on page 71.

Connecting/Using A Stereo System

These instructions enable you to connect your video recorder to your Hi-Fi stereo system (if you have one) and listen to the soundtrack through the stereo.

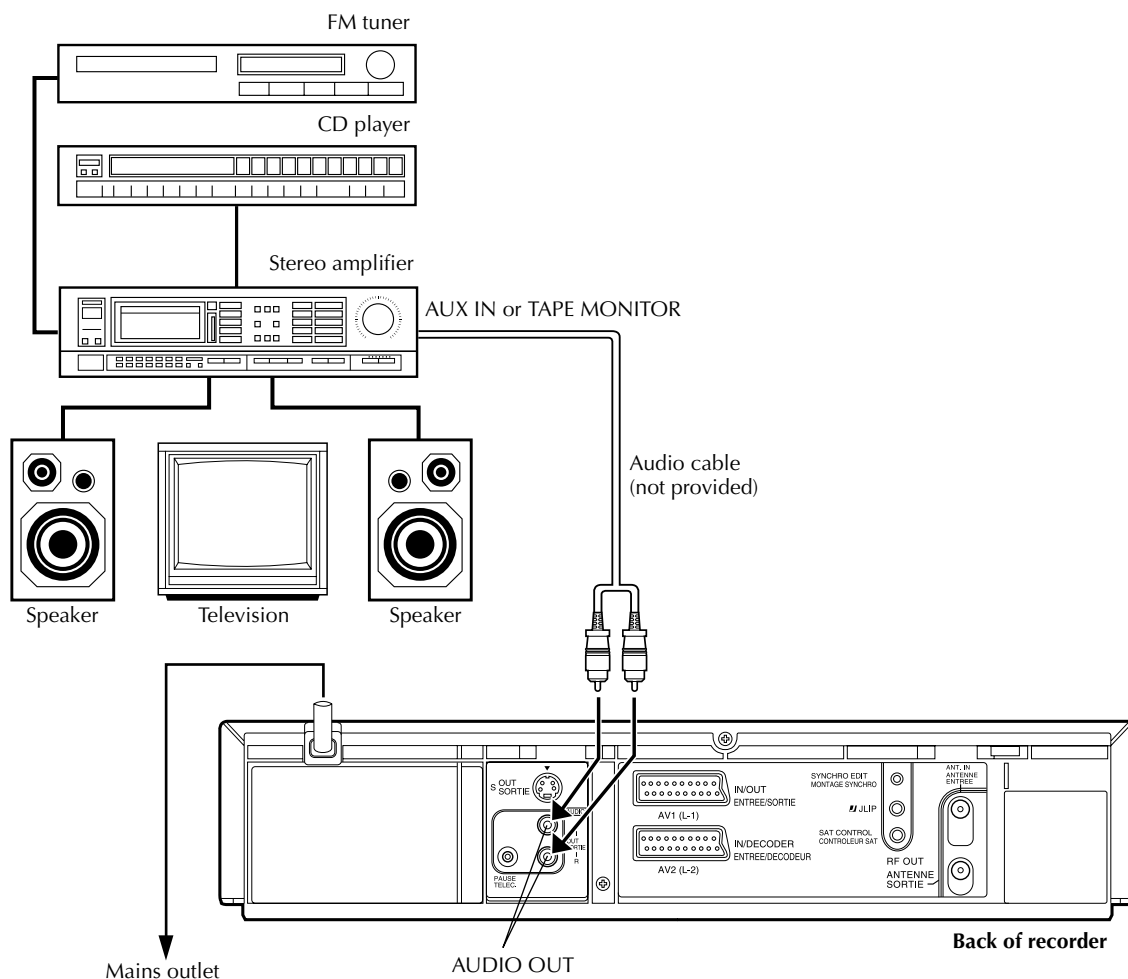

Make connections.

Connect the AUDIO OUT L and R connectors on your video recorder to the AUX IN or TAPE MONITOR connectors on your stereo system's receiver or amplifier.

NOTE:

When listening to sound through the connected stereo system, turn the TV's volume down completely.

CAUTIONS:

- This recorder has a dynamic range of more than 80 dB with regards to its Hi-Fi audio capability. It is recommended that you check the maximum level if you are going to listen to the Hi-Fi audio signals through a stereo amplifier. A sudden surge in the input level to the speakers may damage them.
- Some speakers and televisions are specially shielded to prevent television interference. If both are of the non-shielded type, do not place the speakers adjacent to the TV set as this can adversely affect the video playback picture.

Mode Set

Turn on the TV and select the video channel (or AV mode).

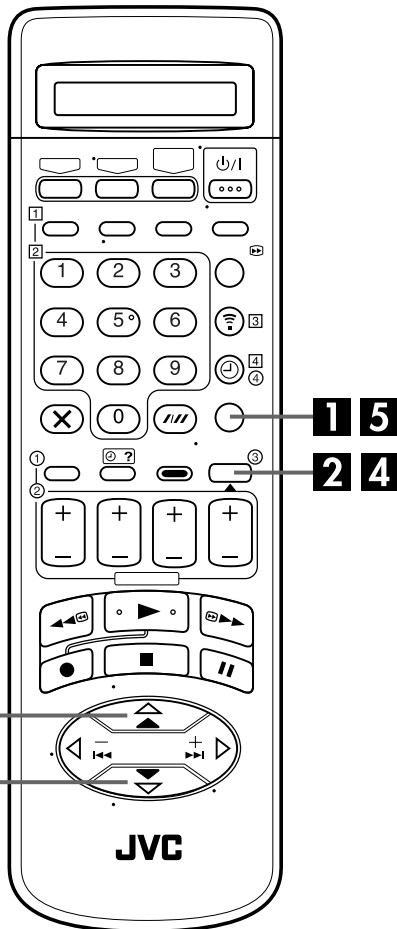

You can change various mode settings on the Mode Set screen by following the procedure described below.

- For each mode setting, see pages 65 to 67.

1 Access the Main Menu screen.

Press MENU.

2 Access the Mode Set screen.

Press Δ / ∇ to move the highlight bar (pointer) to "MODE SET", then press OK or \triangleright .

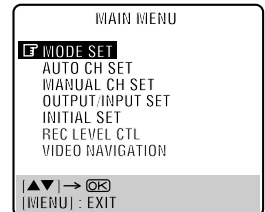

3 Select the mode.

Press Δ / ∇ to move the highlight bar (pointer) to the item you want to change.

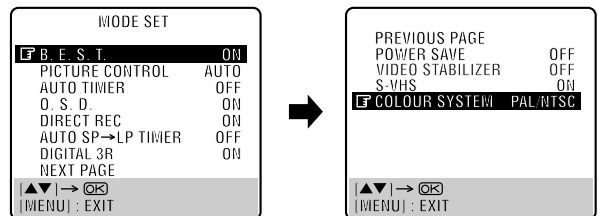

4 Select the mode setting.

Press OK or \triangleright .

5 Return to the normal screen.

Press MENU.

* The default setting is **bold** in the table below.

<p>■ B.E.S.T. ON OFF</p>	<p>You can set the B.E.S.T. (Biconditional Equalised Signal Tracking) system to "ON" or "OFF" (☞ pg. 29).</p>
<p>■ PICTURE CONTROL</p> <p>AUTO: Provides the optimised picture benefits of the B.E.S.T. Picture System.</p> <p>EDIT: Minimizes picture degradation during editing (recording and playback).</p> <p>SOFT: Reduces image coarseness when viewing overplayed tapes containing a lot of noise.</p> <p>SHARP: Clearer, sharper-edged picture when viewing images with lots of flat, same-coloured surfaces such as cartoons.</p>	<p>This feature helps you to adjust the playback picture quality according to your preference. Normally select "AUTO".</p> <p>NOTES:</p> <ul style="list-style-type: none"> • When you select "EDIT", "SOFT" or "SHARP", the selected mode will not change until you select another mode. • When you select "EDIT" to dub tapes, be sure to select "AUTO" after you finish dubbing the tapes. • When "B.E.S.T." is "OFF", "PICTURE CONTROL" switches automatically from "AUTO" to "NORM".
<p>■ AUTO TIMER ON OFF</p>	<p>When this function is set to "ON", the timer is automatically engaged when the recorder power is turned off, and automatically disengaged when the recorder is powered back on.</p> <p>NOTE:</p> <p>For safety, when "AUTO TIMER" is set to "OFF", all other recorder functions are disabled while the Timer mode is engaged. To disengage the timer, press ⊕ (TIMER).</p>
<p>■ O.S.D. ON OFF</p>	<p>When this function is set to "ON", various operational indicators appear on the TV screen. Messages appear in the selected language (☞ pg. 15, 16).</p> <p>NOTES:</p> <ul style="list-style-type: none"> • When you use this recorder as the source player for editing, be sure to set "O.S.D." to "OFF" before starting. • During playback, the operation mode indicators may be disturbed depending on the type of tape being used.
<p>■ DIRECT REC ON OFF</p>	<p>When this function is set to "ON", you can easily start recording the programme that you are watching on your TV. Press and hold ● and press ► on the remote control, or press ● on the recorder.</p> <p>NOTES:</p> <ul style="list-style-type: none"> • When you use the Direct Rec function, be sure to use a TV offering T-V LINK, etc. and connect a fully-wired 21-pin SCART cable between the recorder and the TV (☞ pg. 10). • If "DIRECT REC" is set to "OFF", the ● button functions as described in "Basic Recording" (☞ pg. 24). • During the Direct Rec, "--" appears on the front display panel. • If a programme is recorded with the Direct Rec, the station name will not be registered for the Video Navigation. "----" will be displayed for the station name. • Retake function (☞ pg. 26) does not work during Direct Rec.

* The default setting is **bold** in the table below.

<p>■ AUTO SP→LP TIMER ON OFF</p>	<p>When this function is set to "ON", the recorder automatically switches to LP mode to allow complete recording if there is not enough tape to record the entire programme while timer-recording in SP mode.</p> <p>For Example . . . Recording a programme of 210 minutes in length onto a 180-minute tape</p> <table border="1" data-bbox="491 349 1081 430"> <tr> <td style="text-align: center;">Approximately 150 minutes</td> <td style="text-align: center;">Approximately 60 minutes</td> </tr> <tr> <td style="text-align: center;">SP mode</td> <td style="text-align: center;">LP mode</td> </tr> <tr> <td colspan="2" style="text-align: center;">Total 210 minutes</td> </tr> </table> <p>Make sure you set this function to "ON", before the timer-recording starts.</p> <p>NOTES:</p> <ul style="list-style-type: none"> • If you have programmed the recorder to timer-record 2 or more programmes, the second programme and those thereafter may not fit on the tape if you set "AUTO SP→LP TIMER" to "ON". In this case, make sure the mode is not engaged, then set the tape speed manually during timer programming. • In order to ensure that the recording fits on the tape, this feature may leave a slight non-recorded section at the end of the tape. • There may be some noise and sound disturbance at the point on the tape where the recorder switches from SP to LP mode. • The Auto SP→LP Timer feature is not available during ITR (Instant Timer Recording), and the feature will not work properly with any tapes longer than E-180, or with some tapes of shorter lengths. • If you perform timer recording with both VPS/PDC and the Auto SP→LP Timer activated, and the programme goes beyond its originally scheduled length, there may be times when the programme cannot be recorded in its entirety. 	Approximately 150 minutes	Approximately 60 minutes	SP mode	LP mode	Total 210 minutes	
Approximately 150 minutes	Approximately 60 minutes						
SP mode	LP mode						
Total 210 minutes							
<p>■ DIGITAL 3R ON OFF</p>	<p>When this function is set to "ON", the Digital 3R picture system applies edge correction to the luminance signal to enhance detail.</p> <p>NOTES:</p> <ul style="list-style-type: none"> • Normally it is recommended to keep "DIGITAL 3R" set to "ON". • Depending on the type of tape being used, picture quality may be better with "DIGITAL 3R" set to "OFF". • If you use the recorder as the source player for editing, be sure to set "DIGITAL 3R" to "OFF" before starting. 						
<p>■ POWER SAVE ON OFF</p>	<p>When this function is set to "ON", you can reduce the power consumption while the recorder is turned off.</p> <p>NOTES:</p> <ul style="list-style-type: none"> • During Power Save mode ... <ul style="list-style-type: none"> ... the front display panel will be turned off. ... the Just Clock function (☞ pg. 76) does not work. ... the picture may be distorted momentarily when you turn on/off the recorder. • Power Save does not work when ... <ul style="list-style-type: none"> ... the recorder is in the Timer mode. ... the recorder's power is turned off after timer-recording or Instant Timer Recording. ... the Automatic Satellite Programme Recording mode is engaged (☞ pg. 36). ... "L-2 SELECT" is set to "DECODER" or "SAT" (☞ pg. 51). 						
<p>■ VIDEO STABILIZER ON OFF</p>	<p>When this function is set to "ON", you can automatically correct vertical vibration in the picture when playing back unstable recordings made on another recorder.</p> <p>NOTES:</p> <ul style="list-style-type: none"> • When you finish viewing a tape, be sure to set this function to "OFF". • Regardless of the setting, this function has no effect during recording and during special effects playback. • The on-screen display may jitter vertically when this function is set to "ON". • To watch recordings with close-caption, set this function to "OFF". • Video Stabilizer and Digital TBC/NR cannot be used at the same time. If you activate Digital TBC/NR when "VIDEO STABILIZER" is set to "ON", Video Stabilizer will be automatically turned "OFF". 						

* The default setting is **bold** in the table below.

<p>■ S-VHS ON OFF</p>	<p>Your recorder can record in S-VHS (Super VHS), S-VHS ET or VHS.</p> <ul style="list-style-type: none"> ● To record in S-VHS: Set "S-VHS" to "ON". Then, insert a cassette marked "S-VHS". The S-VHS indicator lights up on the front display panel. The S-VHS recording mode is selected. ● To record in S-VHS ET on a VHS cassette: See "Super VHS ET (S-VHS ET)" on page 27. ● To record in VHS: Insert a cassette marked "VHS". If the S-VHS ET button on the recorder is lit and the S-VHS ET mode is activated, press S-VHS ET. The button's light goes off. The VHS recording mode is automatically selected regardless of the "S-VHS" mode setting. ● To record in VHS on an S-VHS cassette: Insert a cassette marked "S-VHS". The S-VHS indicator lights up on the front display panel. Then, set "S-VHS" to "OFF". The S-VHS indicator goes off. The VHS recording mode is selected. <p>NOTE: <i>When playing back a tape that has been recorded in S-VHS or S-VHS ET, the S-VHS indicator lights up on the front display panel regardless of the "S-VHS" mode setting.</i></p>
<p>■ COLOUR SYSTEM PAL/NTSC: To record PAL signals, or play back a PAL or NTSC tape. MESECAM: To record SECAM signals, or play back a MESECAM tape.</p>	<p>You can play back PAL, NTSC and MESECAM tapes, or record PAL and SECAM* signals on this recorder. Select the appropriate colour system.</p> <p>* SECAM signals will be recorded as MESECAM on this recorder; MESECAM is the designation for tapes with SECAM signals that have been recorded on a MESECAM-compatible PAL video cassette recorder.</p> <p>NOTES:</p> <ul style="list-style-type: none"> ● It is not possible to record in S-VHS if "MESECAM" is selected. The recording mode is forced to change to VHS. ● If "MESECAM" is selected when the tape speed is set to EP mode, the tape speed will be forced to change to LP mode. ● It is not possible to select EP mode if "MESECAM" is selected. <p>About NTSC Playback</p> <ul style="list-style-type: none"> ● Some TVs shrink the picture vertically and place black bars at the top and bottom of the TV screen. This is not a malfunction on the part of either the video recorder or the TV. ● The picture may roll up and down. This can be corrected using the V-HOLD control found on some TVs. (This cannot be corrected if the TV does not have a V-HOLD control.) ● The counter and tape remaining time readings will be incorrect. ● During search, still, or frame-by-frame playback, the picture will be distorted, and there may be a loss of colour. ● Depending on the type of TV, the top and bottom portions of superimposed displays may be cut off during NTSC playback.

Tuner Set

Turn on the TV and select the video channel (or AV mode).

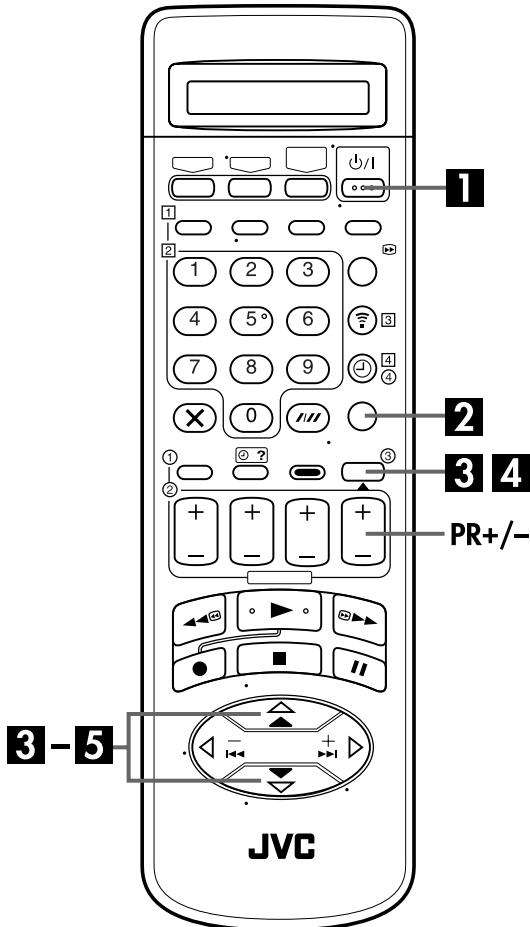

IMPORTANT

Perform the following steps only if —
 — Auto Channel Set has not been set correctly by Auto Set Up or by Preset Download (pg. 12, 14).
 — you have moved to a different area or if a new station starts broadcasting in your area.

Your recorder needs to memorize all necessary stations in channel positions in order to record TV programmes. Auto Channel Set automatically assigns all receivable stations in your area to call them up by using the **PR** buttons without going through any vacant channels.

Auto Channel Set

1 Turn on the recorder.

Press ψ/I .

2 Access the Main Menu screen.

Press **MENU**.

3 Access the Auto Channel Set screen.

Press Δ/∇ to move the highlight bar (pointer) to "AUTO CH SET", then press **OK** or \triangleright .

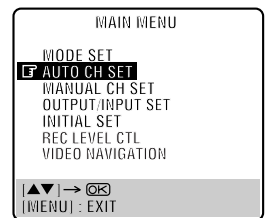

4 Select your country.

Press Δ/∇ to move the highlight bar (pointer) to your country's name, then press **OK** or \triangleright .

5 Select the language.

Press Δ/∇ to move the highlight bar (pointer) to the language of your choice.

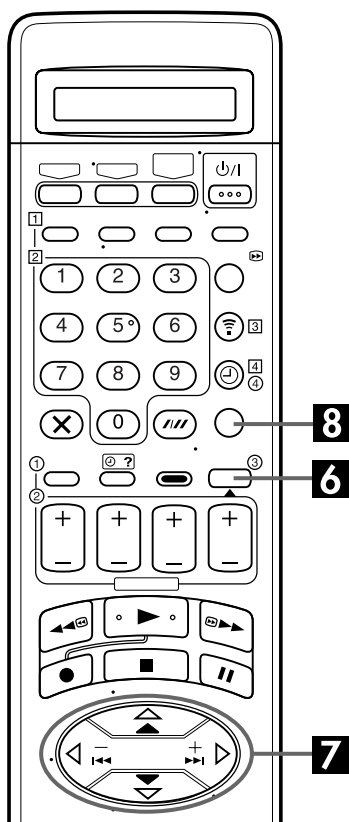

IMPORTANT

- In certain reception conditions, station names may not be stored correctly, and Auto Guide Program Number Set may not work properly. If the Guide Program numbers are not set properly when you timer-record a TV programme using the SHOWVIEW system, the recorder will record a TV programme of a different station. When programming the timer using the SHOWVIEW system, be sure to check the desired channel is selected correctly (pg. 30, "SHOWVIEW Timer Programming").
- Your video recorder memorizes all detected stations even if reception of some of them is poor. You can delete those stations with an unacceptable picture (pg. 71, "Delete A Channel").

NOTES:

- Fine tuning is performed automatically during Auto Channel Set. If you want to perform tuning manually, refer to page 72.
- If you perform Auto Channel Set when the aerial cable is not connected properly, "SCAN COMPLETED -NO SIGNAL-" appears on the TV screen in step 7. When this happens, make sure of the aerial connection and press **OK**; Auto Channel Set will take place again.
- If no sound accompanies the picture or the audio sounds unnatural on some channels that have been stored by Auto Set Up, the TV system setting for those channels may be incorrect. Select the appropriate TV system for those channels (pg. 71, "INFORMATION").

6 Perform Auto Channel Set.

Press **OK** twice.

- If you have connected the recorder and your TV via AV connection (pg. 10), the recorder automatically performs the Preset Download and the T-V LINK screen will appear (pg. 14).
- The Auto Set screen appears, and remains on screen while the recorder searches for receivable stations.

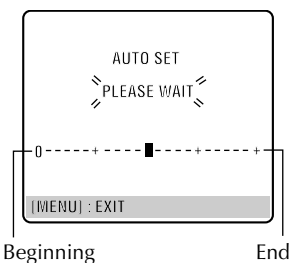

As Auto Channel Set progresses, the "█" mark on the TV screen moves from left to right. Wait until the TV screen as shown in step 7 appears.

7 View the Confirmation screen.

After "SCAN COMPLETED" is displayed on the TV screen for about 5 seconds, the Confirmation screen looking like the one to the right appears. The stations your recorder located appear on a channel positions (PR),

PR	CH	ID	PR	CH	ID
01	25	ARD	08	C26	E-SP
02	C08	SKY1	09	55	WEST
03	10	ZDF	10	C24	SAT1
04	C65	RAI1	11	C23	OSF
05	C31	BBC1	12		----
06	C32	BBC2	13		----
07	C33	3SAT	14		----

▲▼ : CHANNEL POSITION
 → [OK] : EDIT
 → [X] : DELETE
 [MENU] : EXIT

channels (CH) and station names (ID – pg. 73). The blueback screen and the programme currently being broadcast by the blinking station appear alternately for 8 seconds each. To view the next page, use the $\Delta \nabla \triangleleft \triangleright$ button on the remote control.

- The stations located in the selected country appear at the top of the list.
- The Guide Program numbers will also be set automatically during Auto Channel Set.

8 Return to the normal screen.

Press **MENU**.

- Using the Confirmation screen, you can skip or add channel positions, enter station names and perform other operations. Refer to pages 70 – 72 for the procedures.
- Depending on reception conditions, the stations may not be stored in order, and the station names may not be stored correctly.
- For information on scrambled broadcasts, refer to page 71.

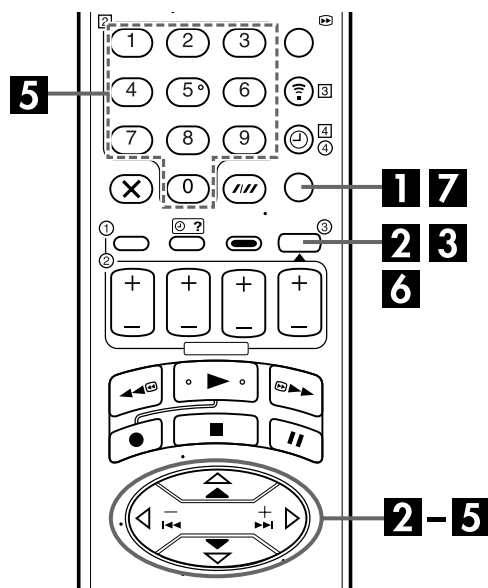

Manual Channel Set

Store channels that were not stored during Auto Set Up (pg. 12), Preset Download (pg. 14) or Auto Channel Set (pg. 68).

1 Access the Main Menu screen.

Press **MENU**.

2 Access the Confirmation screen.

Press $\Delta\nabla$ to move the highlight bar (pointer) to "MANUAL CH SET", then press **OK** or \triangleright . The Confirmation screen appears.

3 Select the channel position.

Press $\Delta\nabla\triangleleft\rangle$ until an open position in which you want to store a channel begins blinking, then press **OK**. The Manual Channel Set screen appears.

(Example) To store in position 12.

PR	CH	ID	PR	CH	ID
01	25	ARD	08	C26	E-SP
02	C08	SKY1	09	55	WEST
03	10	ZDF	10	C24	SAT1
04	C65	RAI1	11	C23	OSF
05	C31	BBC1	12	---	---
06	C32	BBC2	13	---	---
07	C33	3SAT	14	---	---

\uparrow : SELECT
 \leftarrow : CURSOR
 OK : OK
 MENU : EXIT

The blueback screen and the programme currently being broadcast by the selected channel appear alternately for 8 seconds each.

4 Select the band.

Press $\Delta\nabla$ to change the band between CH (regular) and CC (cable), then press \triangleright .

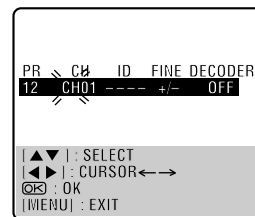

5 Input the channel.

Press the **number keys** to input the channel number you want to store.

- Input "0" before any single number entries.
- To input the registered station name (ID - pg. 73), press \triangleright until "----" (ID setting) begins blinking, then press $\Delta\nabla$.
- For fine tuning adjustment, press \triangleright until "+/-" begins blinking, then press $\Delta\nabla$. While tuning, "+" or "-" appears.
- When storing a channel that sends scrambled broadcasts, press \triangleright until "OFF" (Decoder setting) blinks, then press $\Delta\nabla$ to set "DECODER" to "ON" ("OFF" is the default setting).
- When "L-2 SELECT" is set to "A/V" or "SAT", the "DECODER" setting cannot be changed (pg. 51).

6 Enter new channel information.

Press **OK** and the Confirmation screen appears.

- Repeat steps 3 – 6 as necessary.

7 Close the Confirmation screen.

Press **MENU**.

- To change positions, see "Change Station Channel Position" (pg. 71).
- If you wish to set station names other than the ones registered in your recorder, see "Set Stations (B)" (pg. 72).

ATTENTION

Guide Program numbers are not set when channels are stored manually. If an attempt is made at timer programming with the SHOWVIEW system in this state, the "GUIDE PROG SET" screen appears; set the Guide Program numbers on this screen. (pg. 31, "ATTENTION — Guide Program Number Set")

Or perform "Guide Program Number Set" (pg. 75).

Delete A Channel

Perform steps 1 and 2 of "Manual Channel Set" on page 70 to access the Confirmation screen before continuing.

1 Select the item.

Press $\Delta \nabla \triangleleft \triangleright$ until the item you want to delete begins blinking.

2 Delete a channel.

Press X.

- The item directly beneath the cancelled one moves up one line.
- Repeat steps 1 and 2 as necessary.

3 Close the Confirmation screen.

Press MENU.

Change Station Channel Position

Perform steps 1 and 2 of "Manual Channel Set" on page 70 to access the Confirmation screen before continuing.

1 Select the item.

Press $\Delta \nabla \triangleleft \triangleright$ until the item you want to move begins blinking. Then press OK and the station name (ID) and its channel (CH) number begin blinking.

2 Select the new position.

Press $\Delta \nabla \triangleleft \triangleright$ to move the station to the new channel position, then press OK.

Example: If you moved the station in position 4 to position 2, the stations originally in positions 2 and 3 each move down one space.

PR	CH	ID	PR	CH	ID
01	25	ARD	08	C26	E-SP
02	C08	SKY1	09	55	WEST
03	10	ZDF	10	C24	SAT1
04	C65	RAI1	11	C23	OSF
05	C31	BBC1	12	C25	ESPN
06	C32	BBC2	13		
07	C33	3SAT	14		

➔

PR	CH	ID	PR	CH	ID
01	25	ARD	08	C26	E-SP
02	C65	RAI1	09	55	WEST
03	C08	SKY1	10	C24	SAT1
04	10	ZDF	11	C23	OSF
05	C31	BBC1	12	C25	ESPN
06	C32	BBC2	13		
07	C33	3SAT	14		

- Repeat steps 1 and 2 as necessary.

3 Close the Confirmation screen.

Press MENU.

When Receiving A Scrambled Broadcast

1 Select the decoder mode.

Set "L-2 SELECT" to "DECODER" (pg. 51).

2 Access the Confirmation screen.

Perform steps 1 and 2 of "Manual Channel Set" on page 70.

3 Select the position.

Press $\Delta \nabla \triangleleft \triangleright$ to select the channel position broadcasting scrambled programmes, then press OK twice.

4 Change the decoder setting.

Press \triangleright until "OFF" (decoder setting) begins blinking, and set it to "ON" by pressing $\Delta \nabla$.

5 Return to the Confirmation screen.

Press OK.

- Repeat steps 3 – 5 as necessary.

6 Close the Confirmation screen.

Press MENU.

INFORMATION

If you live in Eastern Europe, "TV SYSTEM" setting appears instead of "DECODER" setting on the Manual Channel Set screen. When you can see the picture but can hear no audio, select appropriate TV system (D/K or B/G). Normally, TV programmes are broadcasted as follows.

For Eastern Europe : D/K

For Western Europe : B/G

- 1 Select a country in Eastern Europe in step 4 on page 68.
- 2 Press \triangleright until the TV system (D/K or B/G) blinking on the Manual Channel Set screen in step 4 on page 70.
- 3 Press $\Delta \nabla$ to select appropriate TV System (D/K or B/G).

Set Stations (A)

Set station names that are registered in your recorder.

Perform steps 1 and 2 of "Manual Channel Set" on page 70 to access the Confirmation screen before continuing.

1 Select the item.

Press $\Delta\nabla$ \triangleleft \triangleright until the item you want begins blinking.

2 Access the Manual Channel Set screen.

Press **OK** twice.

3 Select the new station.

Press \triangleright until the station name (ID) begins blinking, then press $\Delta\nabla$ until the new station's name (ID) you want to store begins blinking. Registered station names (pg. 73) appear as you press $\Delta\nabla$.

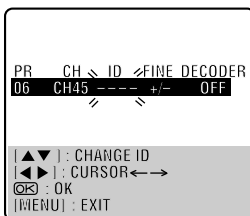

4 Switch the stations.

Press **OK**.

- The Confirmation screen appears.
- Repeat steps 1 – 4 as necessary.

5 Close the Confirmation screen.

Press **MENU**.

Set Stations (B)

Set station names other than the ones registered in your recorder.

Perform steps 1 and 2 of "Manual Channel Set" on page 70 to access the Confirmation screen and then perform steps 1 and 2 of "Set Stations (A)" above before continuing.

1 Select the character for station name.

Press \triangleright until the first letter of the station name begins blinking.

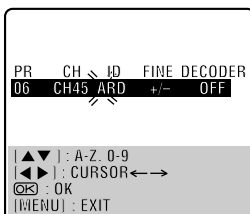

2 Enter the new character.

Press $\Delta\nabla$ to cycle through the characters (A–Z, 0–9, –, *, +, _ (space)) and stop when the desired character is indicated, then press \triangleright to enter. Enter the remaining characters the same way (maximum of 4). After entering all characters, press **OK**.

- The Confirmation screen appears.
- If you make a mistake, press \triangleleft until the incorrect character begins blinking. Then enter the correct character by pressing $\Delta\nabla$.

3 Close the Confirmation screen.

Press **MENU**.

NOTE:

The characters available for the station name (ID) are A–Z, 0–9, –, *, +, _ (space) (maximum of 4).

Fine-Tuning Channels Already Stored

Perform steps 1 and 2 of "Manual Channel Set" on page 70 to access the Confirmation screen before continuing.

1 Select the channel to fine-tune.

Press $\Delta\nabla$ \triangleleft \triangleright until the channel you want to tune begins blinking.

2 Access the Manual Channel Set screen.

Press **OK** twice. The Manual Channel Set screen appears.

3 Perform tuning.

Press \triangleright until "+/-" begins blinking, then press $\Delta\nabla$ until the picture is its clearest. Then press **OK**.

- The Confirmation screen appears.
- Repeat steps 1 – 3 as necessary.

4 Close the Confirmation screen.

Press **MENU**.

TV Station And ID List

ID*	STATION NAME
1000	TV1000
3SAT	3SAT
ADLT	ADULT
ANT3	ANTENA3
ARD	ARD
ARTE	ARTE
BBC	BBC GROUP
BBC1	BBC1
BBC2	BBC2
BR3	BAYERN3
C+	CANAL PLUS
C1	PORTUGUSES
CAN5	CANALE5
CANV	KETNET CANVAS
CH4	CHANNEL4
CH5	CHANNEL5
CHLD	CHILD
CINE	CINEMA
CLUB	TELECLUB
CMT	CMT
CNN	CNN
CSUR	ANDALUCIA
DISC	DISCOVERY
DR	DR TV
DRS	DRS
DSF	DSF
ETB1	ETB1
ETB2	ETB2
EURO	EURONEWS
EUSP	EUROSPORTS
FEMM	FEMMAN
FILM	FILM
FNET	FILMNET
FR2	France2
FR3	France3
GALA	GALAVISION
HR3	HESSEN3
INFO	INFO-KANAL
ITA1	ITALIA1
ITA7	ITALIA7
ITV	ITV
JSTV	JSTV
KA2	KA2
KAB1	KABEL1
KAN2	KANAL2
LOCA	LOCAL
M6	M6
MBC	MBR
MCM	MCM
MDR	MDR
MOVE	MOVIE
MTV	MTV
MTV3	MTV3
N3	NORD3
N-TV	N-TV
NBC	NBC SUPER
NDR3	NDR
NED1	NED1
NED2	NED2
NED3	NED3
NEWS	
NICK	NICKELODEON
NRK	NRK
NRK2	NRK2
ODE	ODEON
ORF1	ORF1
ORF2	ORF2

ID*	STATION NAME
ORF3	ORF3
OWL3	OWL3
PREM	PREMIERE
PRO7	PRO7
RAI1	RAI1
RAI2	RAI2
RAI3	RAI3
RET4	RETE4
21	TELE21
RTBF	RTBF1 or 2
RTL	RTL
RTL2	RTL2
RTL4	RTL4
RTL5	RTL5
RTP	RTP
S4	SCHWEIZ4
SAT1	SAT1
SBS	SBS
SHOW	SHOW
SIC	SOCIEDADE
SKY	SKY CHANNEL
SKYN	SKY NEWS
SPRT	SPORT
SRTL	SUPER RTL
STAR	STAR-TV
SVT1	SVT1
SVT2	SVT2
SWR	SUEDWEST3
TCC	TCC
TELE	TELE
TEL5	TELE5
TF1	TF1
TM3	TM3
TMC	TELEMONTECARLO
TNT	TNT INT
TRT	TRT INT
TSI	TSI
TSR	TSR
TV1	BRTN TV1
TV2	TV2
TV3	TV3
TV4	TV4
TV5	TV5
TV6	TV6
TVE1	TVE1
TVE2	TVE2
TVG	TV GALICIA
TVI	TV INDEPENDENT
TVN	TV NORGE
VCR	VIDEO
VERO	VERONICA
VH-1	VH-1
VIVA	VIVA
VIV2	VIVA2
VMTV	VIDEO MUSIC
VOX	VOX
VT4	VT4
VTM	VTM
WDR1	West1
WDR3	West3
YLE1	YLE1
YLE2	YLE2
ZDF	ZDF
ZTV	ZTV

* The "ID" abbreviation is what is shown on-screen in lieu of the station name. The "ID" abbreviation is listed in the Confirmation screen and is displayed on the TV screen when the recorder is tuned to a different station.

Video Channel Set

Video channel (RF output channel) is the channel on which your TV receives picture and sound signals from the recorder through the RF cable.

IMPORTANT

Perform the following steps only if —

- interference appears in the TV picture after you have moved to a different area or a new station has started broadcasting in your area.
- you change the connection between your recorder and TV from RF connection to AV or S-VIDEO connection, or vice versa.

If you have connected the recorder to your TV via the AV or S-VIDEO connection (☞ pg. 10, 11), since you do not need the video channel you have to set the video channel to off.

If you have connected the recorder to your TV via the RF connection (☞ pg. 10), you have to set the correct video channel.

Before performing the following steps:

Make sure the recorder's power is off and there is no cassette inserted in the recorder.

1 Access the Video Channel Set mode.

Hold down **■/▲** on the recorder until the front display panel shows the following.

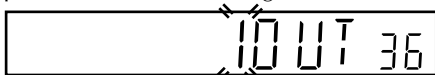

2 Set the RF output system.

The blinking number on the display indicates the RF output system of your country.

- If you have selected MAGYARORSZÁG (36), ČESKÁ REPUBLIKA (42), POLSKA (48), РОССИЯ (07) or OTHER EASTERN EUROPE (EE) for the country setting (☞ pg. 12, 16), press **△▽** to set to "2".
- For other countries, set to "1". Then press **OK**. (1: B/G 2: D/K)



3 Set the video channel.

With AV or S-VIDEO Connection

Press **PR -** until the front display panel shows "10UT--" (or "20UT--").

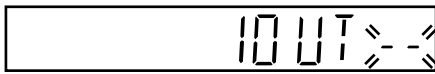

- Now the video channel is set to off.

With RF Connection

Press **PR +** or **-** to set the video recorder to a vacant channel between 22 and 69 which is not occupied by any local station in your area.

(Example) If channel 50 is available in your area

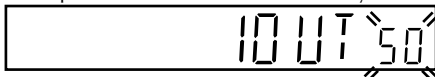

Then set your TV to UHF channel 50.

- If the two vertical white bars appear clearly on the TV screen as shown to the right, go to step 4.
- If the two vertical white bars do not appear clearly, re-set the video recorder to another vacant channel and try again.

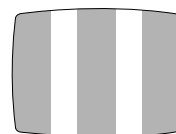

NOTES:

- If you set the video recorder to a channel which is occupied by a local station or has neighbouring channels that are occupied by local stations, the picture reception quality will be affected and some interference noise will appear on the TV screen. Be sure to select a vacant channel which has no broadcast on neighbouring channels.
- If you cannot obtain the two vertical white bars clearly with any channel between 22 and 69, consult your JVC dealer.

4 Exit the Video Channel Set mode.

Press **OK** on the remote control.

With AV or S-VIDEO Connection

To view picture signals from the video recorder, set your TV to its AV mode.

With RF Connection

The channel on which the TV screen in step 3 appears clearly is your video channel.

To view picture signals from the video recorder, set your TV to the video channel.

SHOWVIEW® System Setup

IMPORTANT

Normally, Auto Set Up (☞ pg. 12), Preset Download (☞ pg. 14) or Auto Channel Set (☞ pg. 68) sets the Guide Program numbers automatically. You need to set the Guide Program numbers manually only in the following cases.

- When timer-programming with the SHOWVIEW system, the channel position, where the station you wish to record is received on your recorder, is not selected,

OR

when you add a channel after Auto Set Up, Preset Download or Auto Channel Set has taken place,

—Set the Guide Program number for that station manually.

- When you wish to timer-record a satellite programme with the SHOWVIEW system,

—Set the Guide Program numbers for all satellite broadcasts received on your satellite receiver.

Turn on the TV and select the video channel (or AV mode).

Guide Program Number Set

1 Access the Main Menu screen.

Press **MENU**.

2 Access the Initial Set screen.

Press $\Delta \nabla$ to move the highlight bar (pointer) to "INITIAL SET", then press **OK** or \triangleright .

3 Access the Guide Program Set screen.

Press $\Delta \nabla$ to move the highlight bar (pointer) to "GUIDE PROG SET", then press **OK** or \triangleright .

4 Enter the Guide Program number.

Press $\Delta \nabla$ to enter the Guide Program number for the desired station as shown in the TV listings. Then press **OK** or \triangleright .

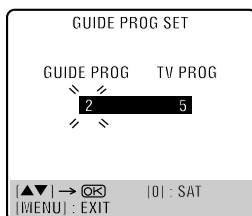

(Example) When inputting the Guide Program number 2 for ZDF.

5 Enter the receiving channel position number.

Press the **number key "0"** to select "TV PROG" or "SAT". Then press $\Delta \nabla$ to input the number of the recorder's channel position on which the Guide Program number's broadcast is received by the recorder or the satellite receiver. Then press **OK** or \triangleright .

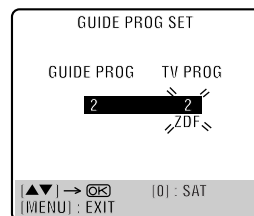

(Example) If ZDF is received on channel position 2.

- To timer-record a satellite programme with the SHOWVIEW system, you need to install the provided Satellite Controller and perform the procedure described in "Satellite Receiver Control Setting" (☞ pg. 17).
- Repeat steps 4 and 5 as necessary.

6 Return to the normal screen.

Press **MENU**.

Guide Program Number

"Guide Program (GUIDE PROG) number" refers to the assigned TV station numbers, according to broadcast area, for the SHOWVIEW timer recording. The Guide Program numbers can be found in most TV listings.

Clock Set

Turn on the TV and select the video channel (or AV mode).

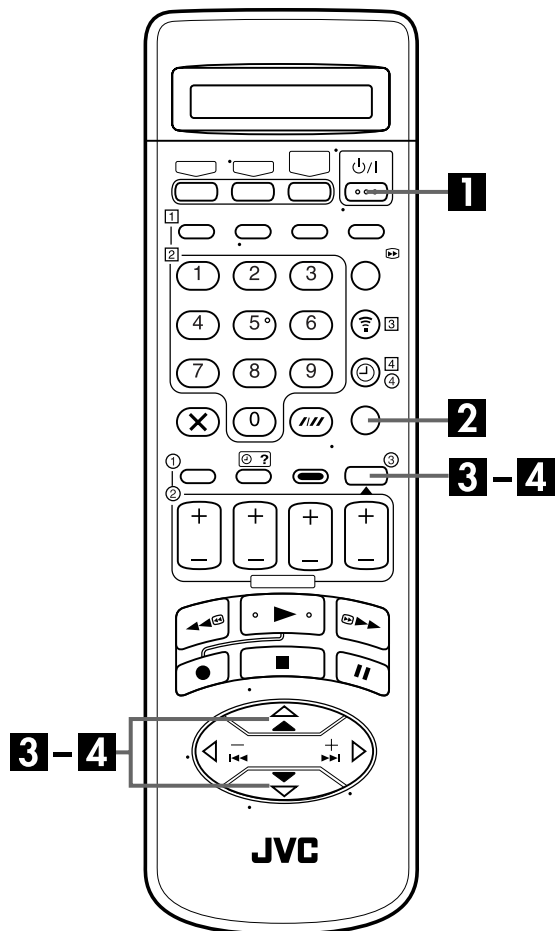

Just Clock

The Just Clock function provides accurate time keeping through automatic adjustments at regular intervals, by reading data from a PDC signal.

The Just Clock option can be set "ON" or "OFF" at the Clock Set screen (the default setting is "OFF"). Press **OK** until the Just Clock setting begins blinking, then press Δ/∇ to change the setting.

IMPORTANT: If you turn off Just Clock, the accuracy of your recorder's built-in clock may be reduced, which could adversely affect timer recording. We recommend you to keep Just Clock on. In cases where the clock setting data from a PDC signal is incorrect, however, you are advised to keep Just Clock set to "OFF".

IMPORTANT

If you performed Auto Set Up (pg. 12), Preset Download (pg. 14) or Auto Channel Set (pg. 68), without ever having set the clock previously, the recorder's built-in clock is also set automatically.

Perform the following steps only if —

—Auto Clock Set has not been performed correctly by Auto Set Up, Preset Download or Auto Channel Set.

OR

—the recorder's memory backup has expired.

OR

—you want to change Just Clock setting (pg. "Just Clock" in the left column).

1 Turn on the recorder.

Press power .

2 Access the Main Menu screen.

Press MENU.

3 Access the Initial Set screen.

Press Δ/∇ to move the highlight bar (pointer) to "INITIAL SET", then press **OK** or \triangleright .

4 Access the Clock Set screen.

Press Δ/∇ to move the highlight bar (pointer) to "CLOCK SET", then press **OK** or \triangleright . The Clock Set screen appears.

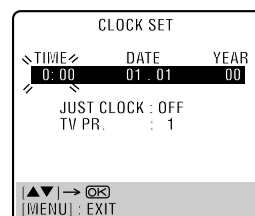

NOTE:

When you have selected *MAGYARORSZÁG (36)*, *ČESKÁ REPUBLIKA (42)*, *POLSKA (48)*, *РОССИЯ (07)* or *OTHER EASTERN EUROPE (EE)* for the country setting (pg. 12, 16), you cannot use Just Clock function. Skip steps 6 and 7 on page 77.

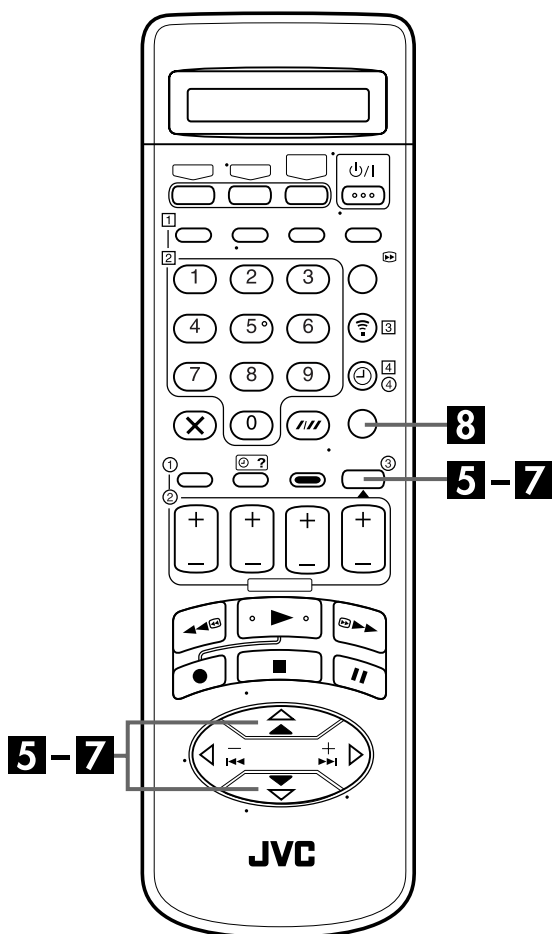

5 Set the date and time.

Press $\Delta\nabla$ to set the time, then press **OK** or \triangleright . The "DATE" display begins blinking. Repeat the same procedure to set the date and year.

- When you set the time, press and hold $\Delta\nabla$ to change the time by 30 minutes.
- When you set the date, press and hold $\Delta\nabla$ to change the date by 15 days.

6 Set Just Clock.

The default setting is "OFF". Set as desired by pressing $\Delta\nabla$, then press **OK** or \triangleright .

- For the Just clock function, refer to "Just Clock" on page 76.
- If you set to "OFF", you can disregard the next step as you won't be able to receive regular clock adjustments.

7 Set the source channel position for clock data.

The recorder is preset to receive clock setting and adjustment data from channel position 1.

Press $\Delta\nabla$ to set the channel position to the number representing the station transmitting clock setting data, then press **OK** or \triangleright .

8 Start the clock operation.

Press **MENU**.

NOTES:

- *Just Clock (when set to "ON") adjusts the recorder's built-in clock every hour, except for 23:00, 0:00, 1:00 and 2:00.*
- *Just Clock is not effective when ...*
 - ... the recorder's power is on.
 - ... the recorder is in the Timer mode.
 - ... a difference of more than 3 minutes exists between the built-in clock's time and the actual time.
 - ... the recorder is in the Automatic Satellite Programme Recording mode (☞ pg. 36).
 - ... the recorder is in the Power Save mode (☞ pg. 66).
 - ... "L-2 SELECT" is set to "SAT" (☞ pg. 51).
- *If Just Clock is set to "ON", the recorder's clock is automatically adjusted at the start/end of Summer Time.*
- *Just Clock may not function properly depending on the reception condition.*

Before requesting service for a problem, use this chart and see if you can repair the trouble yourself. Small problems are often easily corrected, and this can save you the trouble of sending your video recorder off for repair.

POWER

SYMPTOM	POSSIBLE CAUSE	CORRECTIVE ACTION
1. No power is supplied to the recorder.	● The mains power cord is disconnected.	Connect the mains power cord.
2. The clock is functioning properly, but the recorder cannot be powered.	● "⊖" is displayed on the front display panel with "AUTO TIMER" set to "OFF".	Press the ⊖ button to turn the "⊖" indicator off.
3. The remote control won't function.	● The batteries are discharged.	Replace the dead batteries with new ones.

TAPE TRANSPORT

SYMPTOM	POSSIBLE CAUSE	CORRECTIVE ACTION
1. The tape does not run during recording.	● "⏏" is displayed on the front display panel.	Press ▶ to turn the "⏏" indicator off.
2. The tape will not rewind or fast-forward.	● The tape is already fully rewound or fast-forwarded.	Check the cassette.













PLAYBACK

SYMPTOM	POSSIBLE CAUSE	CORRECTIVE ACTION
1. The playback picture does not appear while the tape is running.	<ul style="list-style-type: none"> ● If you are using the RF connection, . . . the TV receiver's channel selector is not set to the video channel. . . . the recorder's video channel has not been correctly set. ● If you are using the AV or S-VIDEO connection, the TV receiver is not set to the AV mode. 	<p>If you are using the RF connection, . . . set the TV receiver to the video channel. . . . perform "Video Channel Set" (ⓘ pg. 74).</p> <p>If you are using the AV or S-VIDEO connection, set the TV to its AV mode.</p>
2. Noise appears during visual search.	● This is normal.	
3. Noise appears during normal playback.	● The automatic tracking mode is engaged.	Try manual tracking. (ⓘ pg. 23)
4. The playback picture is blurred or interrupted while TV broadcasts are clear or "USE CLEANING CASSETTE" message appears on the screen.	● The video heads may be dirty.	Use a dry cleaning cassette TCL-2UX or consult your JVC dealer.
5. Breaks are noticeable in Hi-Fi soundtrack.	● The automatic tracking mode is engaged.	Try manual tracking. (ⓘ pg. 23)

RECORDING

SYMPTOM	POSSIBLE CAUSE	CORRECTIVE ACTION
1. Recording cannot be started.	<ul style="list-style-type: none"> There is no cassette loaded, or the cassette loaded has had its record safety tab removed. 	Insert a cassette, or using adhesive tape, cover the hole where the tab was removed.
2. TV broadcasts cannot be recorded.	<ul style="list-style-type: none"> "L-1", "L-2", "F-1", "S-1" or "SAT" has been selected as the input mode. 	Set to the desired channel.
3. Tape-to-tape editing is not possible.	<ul style="list-style-type: none"> The source (another video recorder, camcorder) has not been properly connected. All necessary power switches have not been turned on. The input mode is not correct. 	<p>Confirm that the source is properly connected.</p> <p>Confirm that all units' power switches are turned on.</p> <p>Set the input mode to "L-1", "L-2", "F-1" or "S-1".</p>
4. Camcorder recording is not possible.	<ul style="list-style-type: none"> The camcorder has not been properly connected. The input mode is not correct. 	<p>Confirm that the camcorder is properly connected.</p> <p>Set the input mode to "L-1", "L-2", "F-1" or "S-1".</p>

TIMER RECORDING

SYMPTOM	POSSIBLE CAUSE	CORRECTIVE ACTION
1. Timer recording won't work.	<ul style="list-style-type: none"> The clock and/or the timer have been set incorrectly. The timer is not engaged. 	<p>Re-perform the clock and/or timer settings.</p> <p>Press  and confirm that "" is displayed on the front display panel.</p>
2. Timer programming is not possible.	<ul style="list-style-type: none"> Timer recording is in progress. 	Timer programming can't be performed while a timer recording is in progress. Wait until it finishes.
3. "  and "  " on the front display panel won't stop blinking.	<ul style="list-style-type: none"> The timer is engaged but there's no cassette loaded. 	Load a cassette with the record safety tab intact, or cover the hole using adhesive tape.
4. The cassette is automatically ejected, and "  and "  " on the front display panel won't stop blinking.	<ul style="list-style-type: none"> The loaded cassette has had its record safety tab removed. 	Remove the cassette and cover the hole with adhesive tape, or insert a cassette with the record safety tab intact.
5. "  blinks for 10 seconds and the Timer mode is disengaged.	<ul style="list-style-type: none">  has been pressed when there are no programs in memory, or the timer record information has been programmed incorrectly. 	Check the programmed data and re-program as necessary, then press  again.
6. The cassette is automatically ejected, the power shuts off and "  and "  " won't stop blinking.	<ul style="list-style-type: none"> The end of the tape was reached during timer recording. 	The programme may not have been recorded in its entirety. Next time make sure you have enough time on the tape to record the entire programme.
7. The SHOWVIEW system does not timer-record properly.	<ul style="list-style-type: none"> The recorder's channel positions have been set incorrectly. 	Refer to "Guide Program Number Set" ( pg. 75) and re-perform the procedure.

OTHER PROBLEMS

SYMPTOM	POSSIBLE CAUSE	CORRECTIVE ACTION
1. Whistling or howling is heard from the TV during camcorder recording.	<ul style="list-style-type: none"> • The camcorder's microphone is too close to the TV. • The TV's volume is too high. 	<p>Position the camcorder so its microphone is away from the TV.</p> <p>Turn the TV's volume down.</p>
2. When scanning channels, some of them are skipped over.	<ul style="list-style-type: none"> • Those channels have been designated to be skipped. 	<p>If you need the skipped channels, restore them (ⓘ pg. 70).</p>
3. The channel cannot be changed.	<ul style="list-style-type: none"> • Recording is in progress. 	<p>Press II to pause the recording, change channels, then press ▶ to resume recording.</p>
4. Channel settings that were made manually seem to have changed or disappeared.	<ul style="list-style-type: none"> • After the manual settings were made, Auto Channel Set was performed. 	<p>Perform manual setting again.</p>
5. No channels are stored in the recorder's memory.	<ul style="list-style-type: none"> • The TV aerial cable was not connected to the recorder when Auto Set Up was performed. • The fully-wired 21-pin SCART cable was not connected between TV and the recorder when Preset Download was performed. 	<p>Turn off the recorder once and connect the TV aerial cable to the recorder properly, then turn on the recorder again. The recorder will try Auto Set Up again (ⓘ pg. 12).</p> <p>Turn off the recorder once and connect the fully-wired 21-pin SCART cable to the recorder properly, then turn on the recorder again. Then perform Preset Download again (ⓘ pg. 14).</p>
6. The remote control won't operate the TV or satellite receiver.	<ul style="list-style-type: none"> • The remote control brand setting is incorrect. 	<p>Re-set the remote control to the correct brand. (ⓘ pg. 38, 39)</p>

ATTENTION

This recorder contains microcomputers. External electronic noise or interference could cause malfunctioning. In such cases, switch the recorder off and unplug the mains power cord. Then plug it in again and turn the recorder on. Take out the cassette. After checking the cassette, operate the unit as usual.

PLAYBACK

Q. What happens if the end of the tape is reached during playback or search?

A. The tape is automatically rewound to the beginning.

Q. During search, slow, still and frame-by-frame playback, I can't hear any audio. What's the problem?

A. This is normal.

Q. Can the video recorder indefinitely remain in the still mode?

A. No. It stops automatically after 5 minutes to protect the heads.

Q. When returning from variable-speed search to normal playback, the picture is disturbed. Should I be concerned about this?

A. No, it is normal.

Q. Noise bar appear during variable-speed search. What's the problem?

A. This is normal.

Q. Sometimes, during Index Search, the video recorder can't find the programme I want to see. Why not?

A. There may be index codes too close together.

RECORDING

Q. When I pause and then resume a recording, the end of the recording before the pause is overlapped by the beginning of the continuation of recording. Why does this happen?

A. This is normal. It reduces distortion at the pause and resume points.

Q. Can the video recorder indefinitely remain in the Record-Pause mode?

A. No. The video recorder goes to its Stop mode automatically after 5 minutes to protect the heads.

Q. What happens if the tape runs out during recording?

A. The video recorder automatically rewinds it to the beginning.

TIMER RECORDING

Q. "○" and "⊖" remain lit on the front display panel. Is there a problem?

A. No. This is a normal condition for a timer recording in progress.

Q. Can I programme the timer while I'm watching a tape or a TV broadcast?

A. You won't see the picture as it is replaced by the on-screen menu, but the audio from the programme or tape you're viewing can be heard.

GENERAL

Power requirement	: AC 220 V – 240 V~, 50 Hz/60 Hz
Power consumption	
Power on	: 25 W
Power off	: 5.2 W
Temperature	
Operating	: 5°C to 40°C
Storage	: -20°C to 60°C
Operating position	: Horizontal only
Dimensions (WxHxD)	
	: 437 mm x 97 mm x 347 mm
Weight	: 4.8 kg
Format	: S-VHS/VHS PAL standard
Maximum recording time	
(SP)	: 240 min. with E-240 video cassette
(LP)	: 480 min. with E-240 video cassette
(EP)	: 720 min. with E-240 video cassette

VIDEO/AUDIO

Signal system	: PAL-type colour signal and CCIR monochrome signal, 625 lines 50 fields
Recording system	: DA4 (Double Azimuth) head helical scan system
Signal-to-noise ratio	: 45 dB
Horizontal resolution	
(SP/LP)	: 250 lines (VHS) 400 lines (S-VHS)
(EP)	: 220 lines (VHS) 350 lines (S-VHS)
Frequency range	: 70 Hz to 10,000 Hz (Normal audio) 20 Hz to 20,000 Hz (Hi-Fi audio)
Input/Output	: 21-pin SCART connectors: IN/OUT x 1, IN/DECODER x 1 RCA connectors: VIDEO IN x 1, AUDIO IN x 1, AUDIO OUT x 1 S-Video connectors: IN x 1, OUT x 1

TUNER/TIMER

TV channel storage capacity	: 99 positions (+AUX position)
Tuning system	: Frequency synthesized tuner
Channel coverage	: VHF 47 MHz – 89 MHz/ 104 MHz – 300 MHz/ 302 MHz – 470 MHz UHF 470 MHz – 862 MHz
Aerial output	: UHF channels 22 – 69 (Adjustable)
Memory backup time	: Approx. 60 min.

ACCESSORIES

Provided accessories	: RF cable, Satellite Controller RM-SD1, Infrared remote control unit, "R6" battery x 2, S-VHS ET labels
----------------------	--

*Specifications shown are for SP mode unless otherwise specified.
E.& O.E. Design and specifications subject to change without notice.*

A		N	
Audio Dubbing.....	54	Next Function Memory	23
Audio Recording Level Control.....	27	O	
Auto Channel Set.....	68	O.S.D.	65
Auto Set Up	12	ON-SCREEN DISPLAY.....	7
AUTO SP→LP TIMER.....	66	Output/Input Set	50
AUTO TIMER.....	65	P	
Automatic Satellite Programme Recording.....	36	PICTURE CONTROL	65
AV Insert Editing.....	57	PLAYBACK.....	20
B		POWER SAVE.....	66
B.E.S.T. Picture System.....	29, 65	Preset Download	14
C		R	
Change Station Channel Position	71	Record One Programme While Watching	
Check, cancel and change programmes	34	Another	25
Clock Set	76	RECORDING.....	24
COLOUR SYSTEM.....	67	Recording Resume Function	24
Connecting To A Satellite Receiver	60	Repeat Playback	23
D		Retake.....	26
Delete A Channel	71	S	
DIGITAL 3R	66	Satellite Controller	17
Digital TBC/NR.....	23	Satellite Receiver Control Setting.....	17
DIRECT REC.....	19, 65	Set Stations (A).....	72
E		Set Stations (B).....	72
EDITING.....	49	SHOWVIEW® System Setup	75
Elapsed Recording Time Indication	25	SHOWVIEW® Timer Programming	30
Express Timer Programming	32	Skip Search.....	22
F		Slow Motion.....	21
Fine-Tuning Channels Already Stored	72	Soundtrack Selection.....	23
G		Still Picture/Frame-By-Frame Playback	21
Guide Program Number Set	31, 75	Super VHS ET (S-VHS ET)	27, 67
H		S-VHS	52, 67
High-Speed (Turbo) Search.....	21	Synchro Editing.....	58
I		T	
Index Search	22	Tape Position Indicator.....	7
Insert Editing	56	Tape Remaining Time	25
Instant Timer Recording (ITR)	25	TIMER RECORDING	30
J		Timer Warning Display	7
Just Clock.....	76	Tuner Set.....	68
L		T-V LINK	19
L-1 INPUT.....	50	TV Station And ID List.....	73
L-1 OUTPUT.....	50	V	
L-2 INPUT.....	51	Variable Speed Search.....	21
L-2 SELECT.....	51	Video Channel Set	74
Language	16	VIDEO NAVIGATION.....	40
M		VIDEO STABILIZER.....	66
Manual Channel Set	70	VPS/PDC Recording.....	33
Manual Tracking	23	W	
Mode Set	64	When programmes overlap each other	35
		When Receiving A Scrambled Broadcast	71

Auto Set Up — referring to the front display panel

The Auto Set Up function sets the tuner channels, clock and Guide Program numbers automatically.

BEFORE YOU START PLEASE MAKE SURE THAT:

- The TV aerial cable is connected to the ANT.IN connector on the rear panel of the video recorder.
- The video recorder's mains power cord is connected to a mains outlet.
- The video recorder is turned off.
- Load batteries into the remote control.

1 Press O/I (recorder/remote).

2 Press $\Delta\nabla$ (remote) to select the international telephone country code.
(Example) DEUTSCHLAND (49) is selected.

International Telephone Country Code

BELGIUM	: 32	ÖSTERREICH	: 43
ČESKÁ REPUBLIKA	: 42	POLSKA	: 48
DANMARK	: 45	PORTUGAL	: 351
DEUTSCHLAND	: 49	SUISSE	: 41
ESPAÑA	: 34	SUOMI	: 358
GREECE	: 30	SVERIGE	: 46
ITALIA	: 39	РОССИЯ	: 07
MAGYARORSZÁG	: 36	OTHER WESTERN EUROPE	: --
NEDERLAND	: 31	OTHER EASTERN EUROPE	: EE
NORGE	: 47		

- If you have selected 32 (BELGIUM) or 41 (SUISSE), press **OK** (remote) and select the language code by pressing $\Delta\nabla$ (remote), then go to step 3.

(Example) FRANCAIS (03) is selected for BELGIUM (32).

International telephone country code Language code

Language Code

ENGLISH	: 01	NORSK	: 08
DEUTSCH	: 02	SUOMI	: 09
FRANCAIS	: 03	DANSK	: 10
ITALIANO	: 04	POLSKI	: 11
CASTELLANO	: 05	ČEŠTINA	: 12
NEDERLANDS	: 06	MAGYAR	: 13
SVENSKA	: 07	ЉЫК	: 14

- If you have selected 36 (MAGYARORSZÁG), 42 (ČESKÁ REPUBLIKA), 48 (POLSKA), 07 (РОССИЯ) or EE (OTHER EASTERN EUROPE), press **OK**. The Clock Set screen appears. Set the clock manually (☞ pg. 76), then go to step 3.
- If you have selected any other country name (code), press **OK** and go to step 3.

3 Press **OK** (remote). "Auto" appears on the front display panel.

4 Press **OK** (remote) to start Auto Set Up. Do NOT press any button on the video recorder or remote control during "Auto" is blinking.

- If you have connected the recorder to your TV via the AV connection (☞ pg. 10), the recorder will automatically perform Preset Download (☞ pg. 14) instead of the Auto Set Up.
 - If "--:--" appears on the front display panel, see page 15 of the instructions.
- * Once you have performed Auto Set Up, even if the recorder's memory backup has expired, the recorder will not perform Auto Set Up again. Perform tuner setting (☞ pg. 68) and/or clock setting (☞ pg. 76) as required.

FOR MORE INFORMATION SEE
INSTRUCTIONS ON PAGE 12

JVC

VICTOR COMPANY OF JAPAN, LIMITED

Free Manuals Download Website

<http://myh66.com>

<http://usermanuals.us>

<http://www.somanuals.com>

<http://www.4manuals.cc>

<http://www.manual-lib.com>

<http://www.404manual.com>

<http://www.luxmanual.com>

<http://aubethermostatmanual.com>

Golf course search by state

<http://golfingnear.com>

Email search by domain

<http://emailbydomain.com>

Auto manuals search

<http://auto.somanuals.com>

TV manuals search

<http://tv.somanuals.com>