

# Side by Side Refrigerator Guide



## *Table of Contents*

*Introduction* . . . . . 1

*Safety Instructions* . . . . . 2

*Installation Instructions* . . . . . 3

*Features at a Glance* . . . . . 4

*Temperature Controls* . . . . . 5

*Interior Designs* . . . . . 6-11

*Ice Service* . . . . . 12

*Ice and Water Service* . . . . . 13-14

*Water Filter Information* . . . . . 14-16

*Refrigerator Cleaning Chart* . . . . . 17

*Storage and Maintenance* . . . . . 18

*Food Storage Tips* . . . . . 19

*Food Storage Chart* . . . . . 20

*Before You Call* . . . . . 21

*Notes* . . . . . 22

*Warranty* . . . . . 23



# 1 Introduction



Congratulations on the purchase of a Jenn-Air refrigerator!

We appreciate your purchase decision and feel confident you will be happy with this appliance for years to come. For best results, we suggest reading this guide carefully. You will find instructions on the proper operation and maintenance of your refrigerator. Additionally, food storage information has been included for you.

Should you ever need our future assistance with your refrigerator, a complete model and serial number recorded in the spaces below will be extremely helpful. These numbers are found on a data plate inside the refrigerator compartment on the upper surface.

Please keep your sales slip or cancelled check. Should any warranty service be required, proof of original date of purchase is needed. For additional questions, please contact us:

**Jenn-Air Customer Assistance**  
**Maytag Appliances Sales Company**  
**Attn: CAIR® Center**  
**P.O. Box 2370**  
**Cleveland, TN 37320-2370**  
**1-800-688-1100 USA and CANADA**  
**1-800-688-2080 TTY USA**  
**(Mon.-Fri., 8am-8pm Eastern Time)**  
**Internet: <http://www.jennair.com>**

**In our continuing effort to improve the quality of our refrigerators, it may be necessary to make changes to the appliance without revising this guide.**

NEWTON	IA	LISTED HOUSEHOLD REFRIGERATOR	
USA 50208		MODEL NO.	
		SERIAL NO.	
		REV. NO.	
		MAX. AMPS	
FOR ICEMAKER OPTION		ELEC. RATING	115V 60HZ
USE KIT			0Z.
<small>ALSO VERIFIED IN ACCORDANCE WITH ENERGY STANDARD CAN/CSA C398-M91</small>			

Model Number

---

Serial Number

---

Revision Number

---

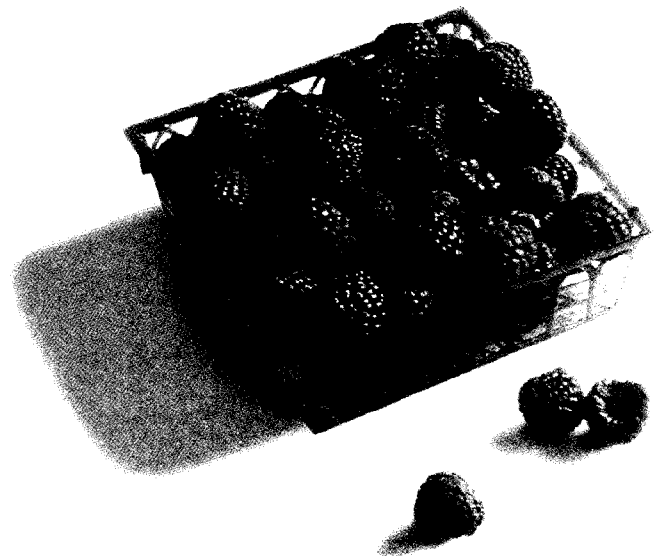

# Important Safety Instructions 2

**⚠ WARNING — When using your appliance, always follow basic precautions, including the following:**

- Use the refrigerator only for its intended purpose.
- To prevent possibility of hazard due to electrical shock, never plug the refrigerator into a receptacle which has not been grounded adequately and in accordance with the local and national electrical codes. See the ⚠ warning and grounding instructions below.
- Unplug the refrigerator before cleaning or replacing a light bulb.
- In case of power failure, minimize door openings. If the power failure is of a long duration, protect the food by placing blocks of dry ice on top of the packages or check with a local frozen foods locker about temporary storage. Frozen foods which have thawed completely should not be refrozen and should be discarded.
- Any electrical service cord that becomes frayed or damaged should be immediately repaired or replaced. Never unplug your appliance by pulling on the power cord.
- Your refrigerator should not be operated in the presence of explosive fumes.
- Children should not climb, hang or stand on the shelves of this refrigerator.

**Important:** Child entrapment and suffocation are not problems of the past. Junked or abandoned refrigerators are still dangerous... even if they will sit for "just a few days." If you are getting rid of your old refrigerator, please follow the instructions below to help prevent accidents.

- Take off the doors.
- Leave the shelves in place so that children may not easily climb inside.

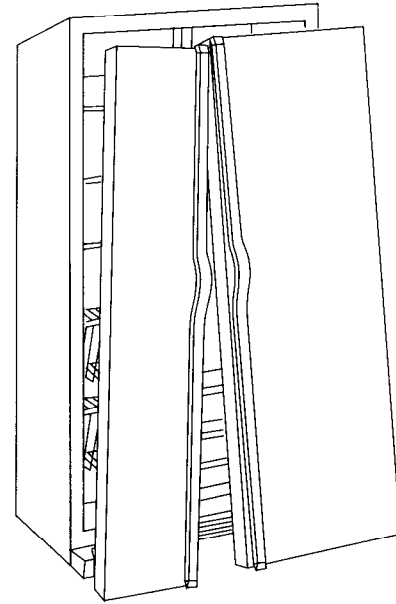

**⚠ WARNING — This appliance is designed to operate on a normal 115 volt, 15 amp, 60 cycle line. There should be a separate, grounded circuit serving this appliance only. Do not use an extension cord. Do not use any device that will alter the electrical performance of this appliance.**

This appliance is equipped with a three-pronged grounding plug for your protection against possible electrical shock hazards. It must be plugged into a grounding receptacle. Where a standard two-prong wall receptacle is encountered, it is the personal responsibility and obligation of the customer to have it replaced with a properly grounded three-prong wall receptacle. Do not under any circumstances, cut or remove the third (ground) prong from the power cord. Do not use an adapter plug. Do not use an extension cord.

POWER SUPPLY CORD  
WITH 3-PRONG  
GROUNDING PLUG

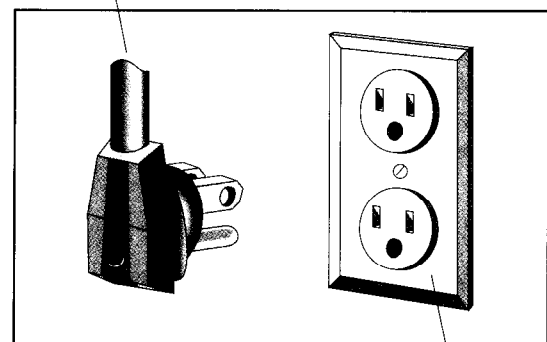

GROUNDING TYPE  
WALL RECEPTACLE

**Save These Instructions**

# 3 Installation Instructions

Your new refrigerator was packed carefully for shipment. Remove and discard shelf packing clips (if used) located just above each shelf where they hook onto the frame. To remove plastic clips wiggle the clips sideways and pull straight out.

## Location of Your Refrigerator

- Allow for a free flow of air through the front base grille.
- Install the refrigerator where the room temperature will not go below 55° F. With temperatures below 55°, the refrigerator will not run frequently enough to maintain proper temperature in the freezer.
- Allow a minimum 1/2" clearance on the sides, top and back for ease of installation. If the refrigerator is placed with the door hinge side against a wall, you may want to allow additional space so the door can be opened wider.
- Use caution when installing the unit on vinyl or hardwood floors so as not to mark or otherwise damage the flooring. A piece of plywood, a rug or other material should be used to protect the floor while positioning the unit.

## Energy Saving Tips

- Locate the refrigerator away from heat producing appliances such as the range or dishwasher, heat vents and direct sunlight.
- Level the refrigerator and do not block ventilation around the front grille.
- Keep the freezer full to near capacity so less cold air will escape during door openings. When the freezer is less than two-thirds full, place milk cartons half full of water in the freezer.
- Let hot dishes cool slightly before putting into the refrigerator or freezer.
- Cover liquids.
- Wipe moisture from the outside of containers before placing them into the refrigerator.
- Avoid opening the doors too often.

## Leveling is Important

To enhance appearance and to maintain optimal performance, the refrigerator must be level. Your refrigerator has wheels which can be adjusted for leveling:

- Remove the lower hinge covers (see fig. 1). To do this, grasp each cover near the hinge and apply pressure. The attachment tabs will snap out, allowing removal of the covers.
- Adjust the wheels with a screwdriver (see fig. 2).
- To lock the cabinet in place, turn down both leveling/lock feet, located near the front wheels (see fig. 3). Rear leveling/lock feet are not required.
- Replace the hinge covers.
- If the floor is not level and it is necessary to raise the rear of the cabinet, we suggest rolling the rear wheels onto a piece of plywood or other shim material.

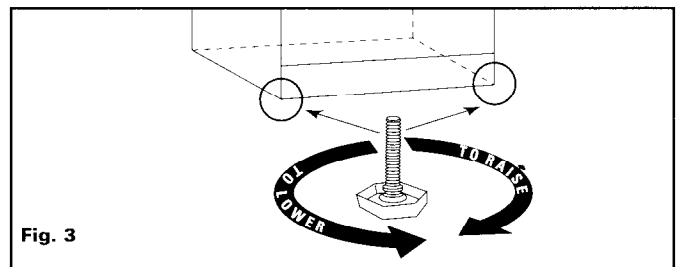
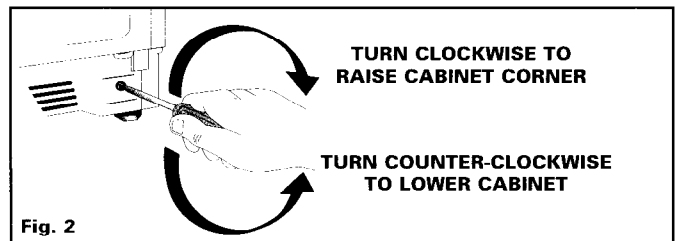
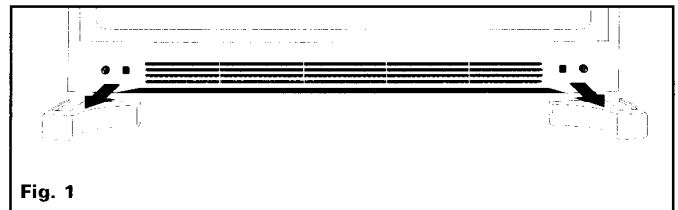

# Features at a Glance 4

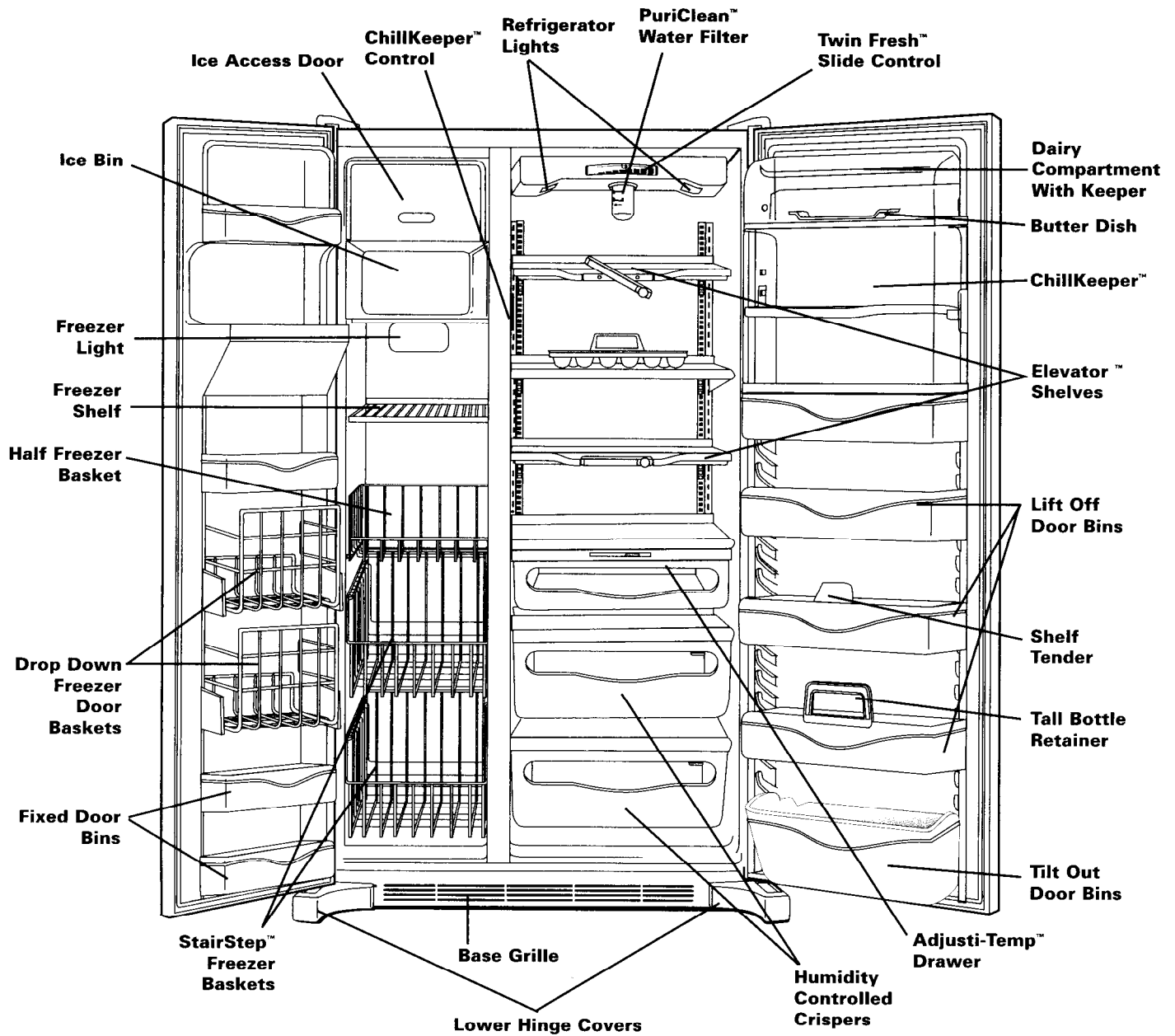

Features may vary according to model.

# 5 Temperature Controls

Your refrigerator has Twin Fresh™ Climate Control. The controls for setting the temperature in the fresh and frozen food compartments are located at the top front of the fresh food compartment.

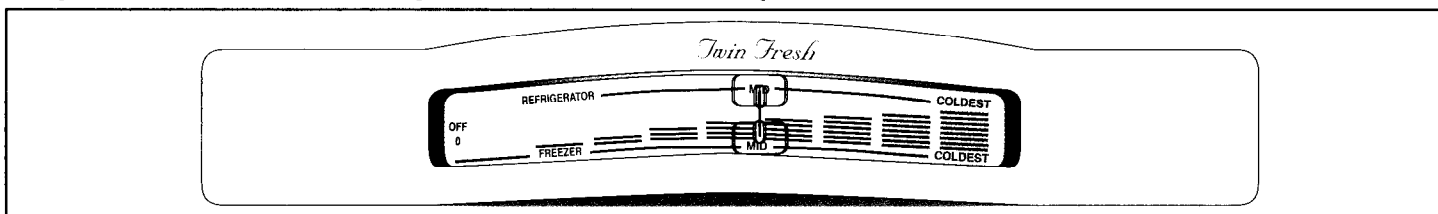

To adjust the controls, move the slide to the left or right as desired

## Twin Fresh™ Climate Control Settings

- The refrigerator control has settings from warmest to coldest. Initially set this control at the midpoint.
- The freezer control has settings from off/warmest to coldest. Initially set this control at the midpoint.
- Let the refrigerator run at least 8-12 hours before adding food.

## Adjusting the Twin Fresh™ Climate Controls

- 24 hours after adding food, you may decide that one or both compartments should be colder or warmer. If so, adjust the control(s) as indicated in the table below.
- Except when starting the refrigerator, do not change either control more than one setting at a time.
- Allow 24 hours for temperatures to stabilize before resetting.
- Changing either control will have some effect on the temperature of the other compartment.

TWIN FRESH™ CLIMATE CONTROL GUIDE	
Refrigerator too Warm	Slide the refrigerator control to next higher setting.
Refrigerator too Cold	Slide the refrigerator control to next lower setting.
Freezer too Warm	Slide the freezer control to next higher setting.
Freezer too Cold	Slide the freezer control to next lower setting.
Turn Refrigerator Off	Slide freezer control to OFF.

**Note:** Sliding the freezer control to OFF stops cooling in BOTH compartments. It does not shut off power to the refrigerator.

## Warm Cabinet Surfaces

At times, the front of the refrigerator cabinet may be warm to the touch. This is a normal occurrence that helps prevent moisture from condensing on the cabinet. The condition will be more noticeable when you first start the refrigerator, during hot weather and after excessive or lengthy door openings.

## No Defrosting

Your refrigerator is designed to defrost automatically.

**Note:** During the automatic defrost cycle, you may notice a red glow/reflection in the vents on the back wall of the freezer compartment and you may hear the sound of water droplets coming into contact with the defrost heater. This is normal during the defrost cycle.

## Shelves

### Fresh Food Compartment and Door

#### Elevator™ Shelf

The **Elevator™** shelf is equipped with a spill-retaining edge and the **Easy Glide** slide-out feature. It can be adjusted up or down without unloading. To slide out, grasp the front of the shelf and pull forward. Push the shelf in to return to original position.

**To adjust the Elevator™ shelf:** Pull out the knob on the crank handle. Rotate the crank clockwise to raise the shelf, and counterclockwise to lower the height of the shelf.

**To remove:** To remove the Elevator™ shelf for occasional cleaning, completely unload the shelf and pull the shelf forward. When the shelf stops, press up on the tabs located underneath its outside edges, then continue pulling forward, clear of the frame.

**To replace:** Align the shelf to the frame and push it all the way back. It is not necessary to depress the tabs for reinstallation.

In ordinary use, the **Elevator™** shelf frame assembly does NOT require removal. Though unlikely, and not recommended, the correct removal procedure is as follows:

- Unload the shelf completely.
- Slide the shelf forward about two inches and manually move the two rear latches toward the shelf center.
- While supporting the entire shelf and frame from underneath, lift slightly and rotate the assembly approximately 30° to allow the rear mechanism to clear the vertical rear side rails.
- The entire assembly can then be moved forward and clear of the refrigerator compartment.
- To reinstall, reverse the removal procedure. Be sure the shelf is in a level position. When the sliding shelf is pushed to the rear, it will reposition the rear latches to their correct operating position.

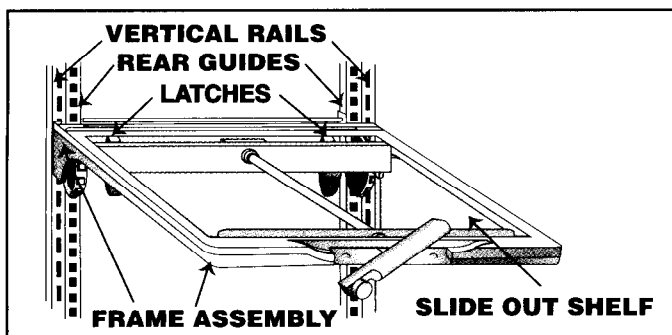

(Style may vary)

The fresh food compartment also may be equipped with adjustable, **Spill-Catcher™** shelves. These shelves have a spill retainer edge for easy clean up.

In some models, these shelves have the slide out feature. To slide out, simply grasp the front of the shelf and pull. Gently push in to return the shelf to the original position.

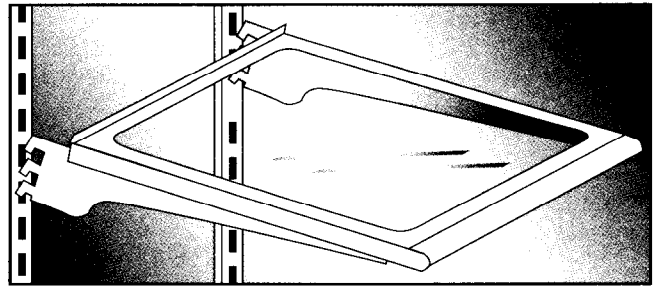

These shelves can be moved for varying food storage needs.

To remove a shelf:

- completely unload the shelf
- slightly lift up the rear of the shelf
- pull the shelf straight out

To lock a shelf into another position:

- tilt up the front edge of the shelf
- insert the hooks into the desired frame openings
- let the shelf settle into place
- be sure the shelf is securely locked at the rear before reloading

# 7 Interior Designs

---

The **Lift Off Door Bins** are roomy enough to handle gallon-plus sized containers. They are adjustable and can be easily removed.

To remove:

- Lift the shelf front up until it clears the retainers on the door liner.
- Pull the bin straight out

To replace:

- Reverse the above procedure.

In some models the bottom door bin is fixed, so it is not adjustable.

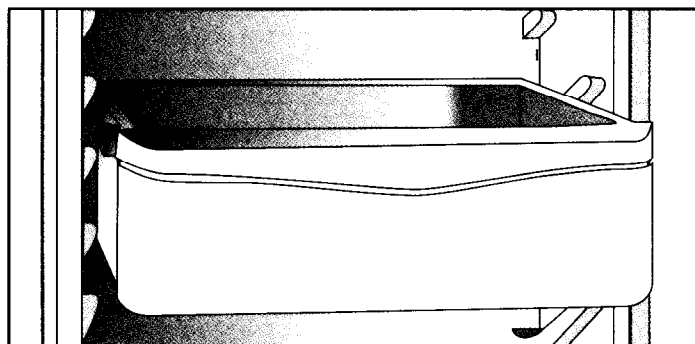

A **Shelf Tender** is located in one refrigerator door bin (certain models have two tenders). Shelf tenders secure bottles and other containers in their upright position and are easily adjusted by sliding sideways.

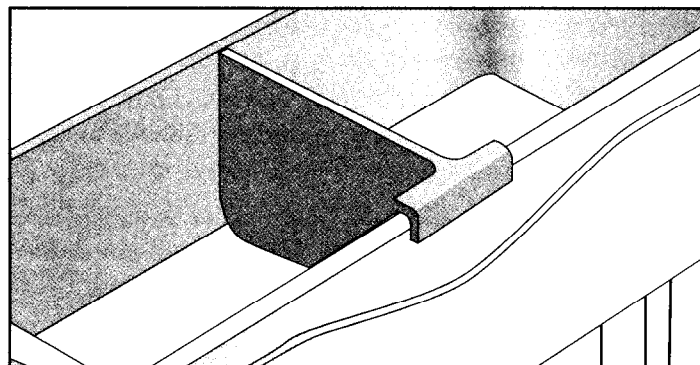

The **Tall Bottle Retainer** is designed to prevent tall bottles from tipping forward. It is easily adjusted by sliding from side to side.

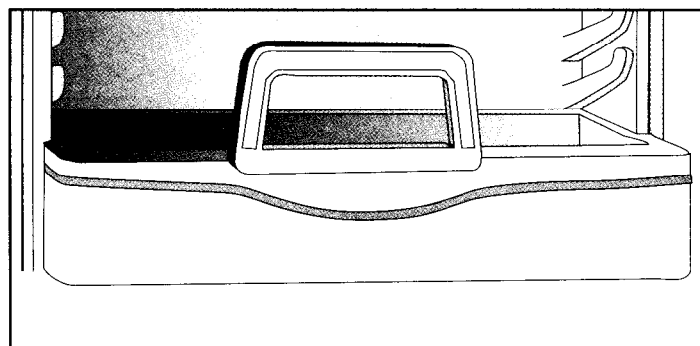

The **Tilt Out Refrigerator Door Bin** (certain models) is ideal for storing awkward containers such as liter bottles and bagged items. By tilting the bin outward, space is opened up to conveniently load or retrieve contents.

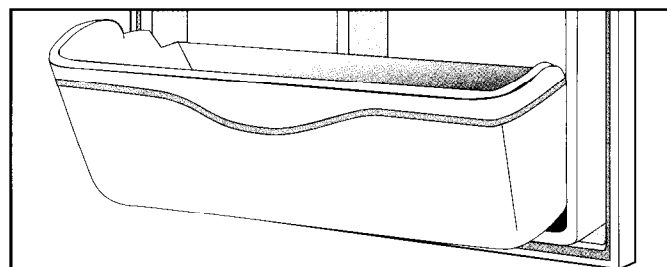



## Freezer Compartment

The freezer of the model you have chosen has either wire or glass shelves. The shelves rest on support rails which are molded into the wall of the freezer. Some models have freezer shelves that slide forward for easier access to the rear of the shelf.

To remove a freezer shelf:

- Empty the shelf of its contents & lift straight up.
- Tilt the shelf sideways & pull it straight out.

To replace the freezer shelf, reverse the removal procedure.

The freezer compartment also has one or more freezer baskets for food storage. These baskets slide out for more convenient access to the frozen foods. They rest and slide on support rails which are molded into the wall of the freezer.

To remove a freezer basket:

- Slide basket out until it stops.
- Depress tabs located at the rear of each side of the basket.
- Continue sliding the basket out.

To replace a freezer basket:

- Line the basket up to the appropriate support rails.
- Slide it into place.



## StairStep™ Freezer Baskets

Certain models feature StairStep™ baskets for the bottom two freezer baskets. These two baskets interact for total accessibility to their contents.

To use:

- Pull the lower basket forward to gain access to its contents. Continue pulling the lower basket to open the upper basket as well. Reverse the action to close both baskets.
- Pulling forward the upper basket provides access to its contents. The lower basket will also move forward but will not open.

To remove the baskets:

- Pull forward on the upper basket until it stops.
- Lift up slightly and continue pulling forward.
- The baskets are removed together.

To replace:

- Reverse the above procedure.

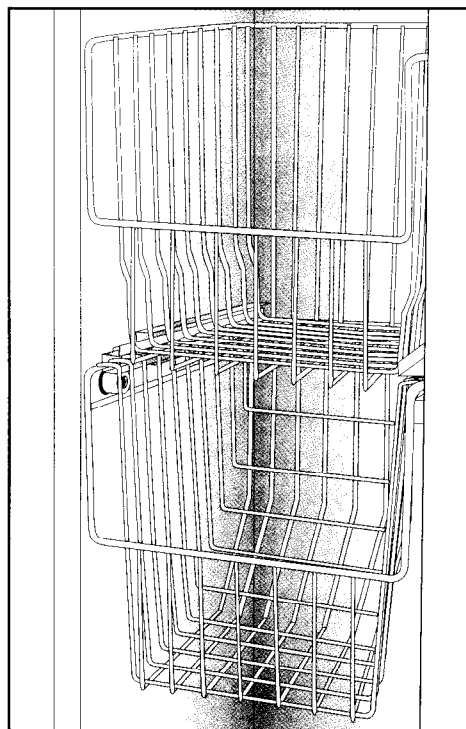
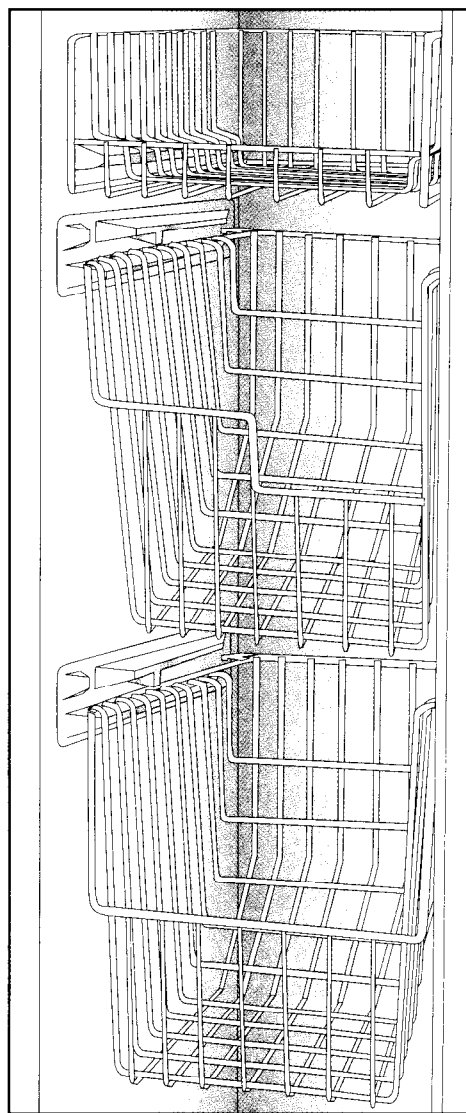

# 9 Interior Designs

---

## Drop Down Freezer Door Baskets

Two drop down freezer door baskets provide convenient storage for items that tend to shift or slide (such as bagged vegetables) when the door is opened and closed.

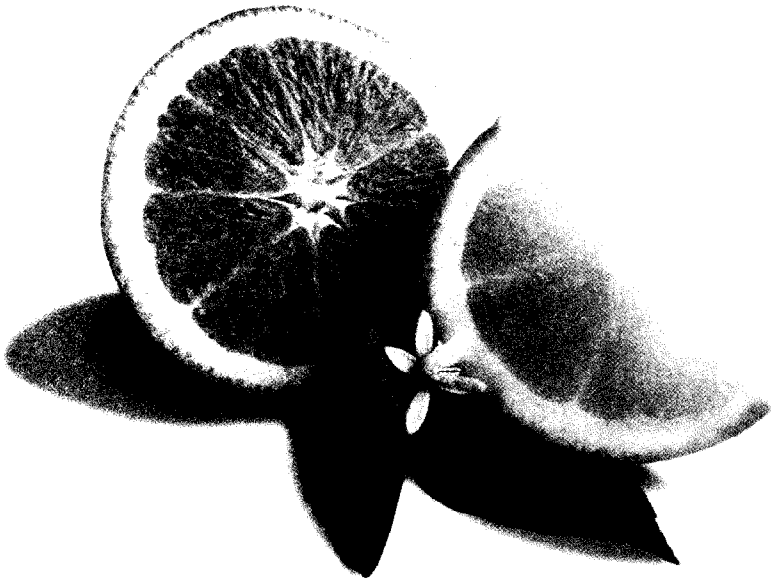
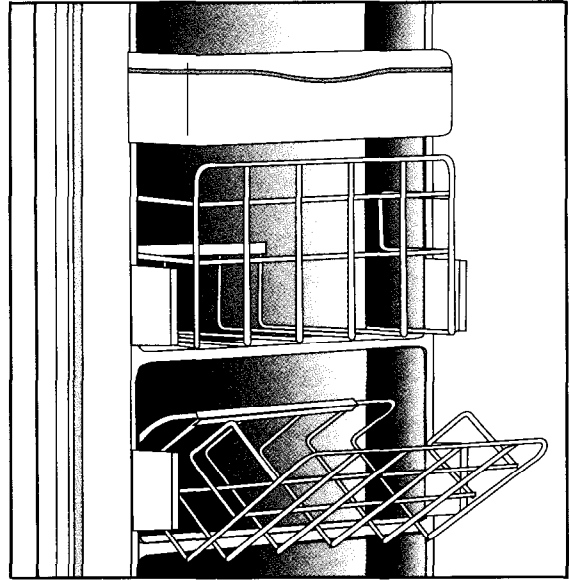

## Specialized Storage Areas

Your refrigerator has an **Adjusti-Temp™** meat storage drawer. This drawer is designed to provide a short term storage area for fresh meats, cheeses and luncheon meats.

The **Adjusti-Temp™ Drawer** is the top drawer in the fresh food compartment. The temperature control for this drawer is located on the shelf front above the drawer. Slide the control left or right to achieve the desired internal temperature of the drawer. The “cool” setting provides a temperature similar to that of the surrounding fresh food compartment. The “cold” setting provides a lower temperature within the drawer which is recommended when storing fresh meat, poultry or fish.

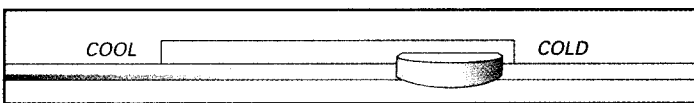

To remove this drawer for cleaning:

- pull the drawer out until it stops
- lift the drawer up slightly and pull it out

To replace the drawer:

- reverse above procedure

***For best results, keep this drawer closed tightly.***

The **Crispers** are ideal for storage of fruit and vegetables. They are equipped with an automatic humidity control system.

### Automatic Humidity Control

A fabric-like material\* covers small air vents in the shelf insert above the crispers.

This material controls the flow of moisture out of the crisper to provide the optimum environment for your food. If a food spill should occur on the air vent or fabric-like material, wipe with a clean, damp cloth.

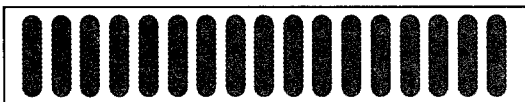

\*Maytag Automatic Humidity Control system features a unique, patented material called Shape Memory Polymer (SMP) that when laminated to fabric, becomes DIAPLEX. DIAPLEX is manufactured by Mitsubishi.

**DIAPLEX**  
The Intelligent Texture

To remove a crisper drawer for cleaning:

- pull out the crisper until it stops
- tilt the drawer front up and pull it out

To replace a crisper drawer:

- align the drawer in the tracks
- lift the drawer front and slide in

***For best results, keep the crispers tightly closed.***

The sealed cover of the top drawer serves as the lower refrigerator shelf.

To remove the cover:

- lift the front edge of the shelf
- pull the shelf straight out

To replace the cover:

- set the rear bars on the support
- push the shelf back until the front edge can be lowered into place

# 11 Interior Designs

## ChillKeeper™

Use the main compartment of the ChillKeeper™ (certain models) to quick chill items and to store your favorite cold drinks.

To open the compartment, grasp the opening on the right side of the compartment cover and swing to the left. The compartment will automatically latch when the compartment cover is gently closed. If the latching mechanism is accidentally dislocated, place the eraser end of a pencil next to the latch and apply gentle pressure to the right.

There is a control for the ChillKeeper™ located on the left wall of the fresh food compartment. The slide control allows customization of the temperature within this compartment. The “Cool” setting provides a more moderate temperature. Sliding the control to “Cold” will provide colder temperatures within the compartment.

The ChillKeeper™ shelf can be used to create a 2 tier storage area within the compartment. If unneeded, the shelf can be detached, inverted and snapped onto the upper-most tabs, out of the way. This creates a larger storage space within the compartment.

There is a utility drawer located at the bottom of the ChillKeeper™. The lock for this drawer is located on the left side of the drawer. To open the drawer, move the pin to the “Unlock” position and the drawer will slide open. To close, gently slide the drawer back in and move the pin into the “Lock” position.

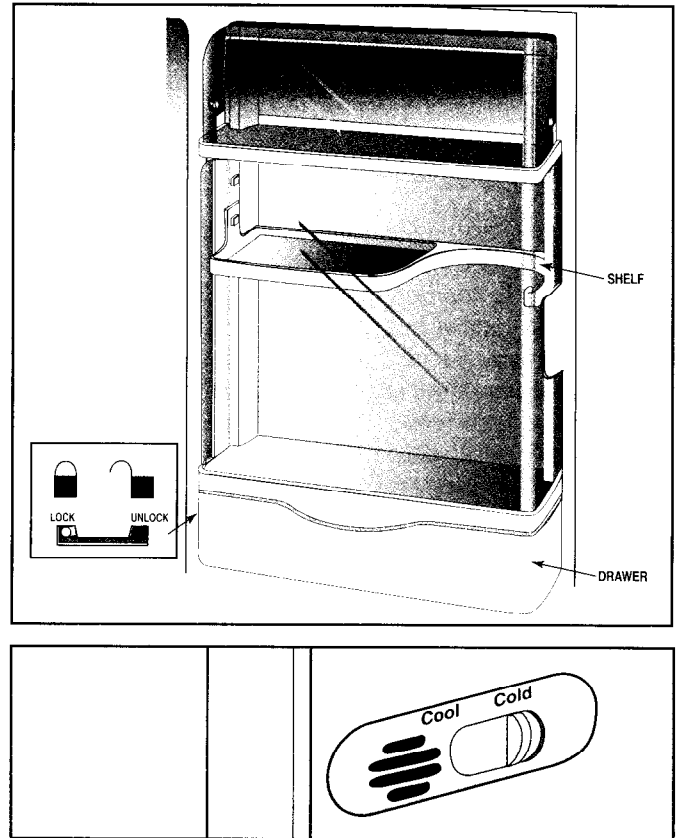

## Dairy Compartment

To use the roomy Dairy Compartment, simply raise the cover. Depending on which model you have chosen, this compartment may come equipped with a **Tender** to secure compartment contents in place or a **Butter Dish**.

Slide the **Tender** from side to side for desired placement.

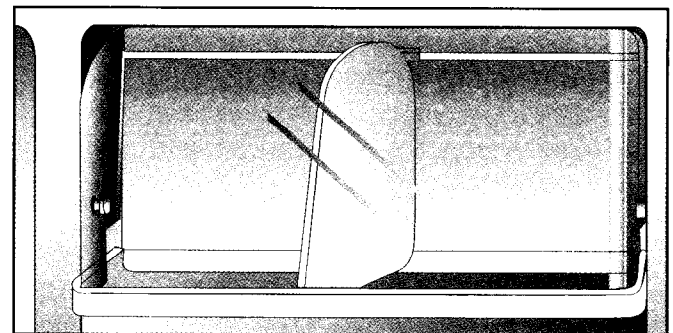

## Egg Caddy

The **Egg Caddy** (style may vary) holds a “dozen-plus” eggs. It can be removed to be washed or carried to a work area.

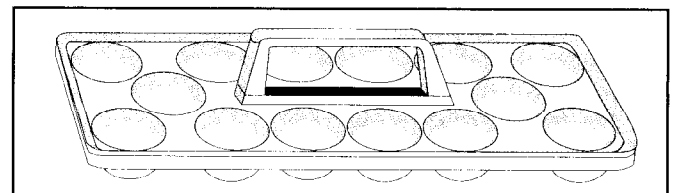

## Nondispenser Models

The freezer compartment of your refrigerator is equipped with ice cube trays and an ice storage bin. The bin is designed to stack neatly on top of the stacked ice cube trays. To release the ice cubes from a tray, hold the tray upside down over the bin and twist both ends.

Your refrigerator is automatic ice maker ready. The number for the ice maker kit you need appears on the data plate (see page 1).

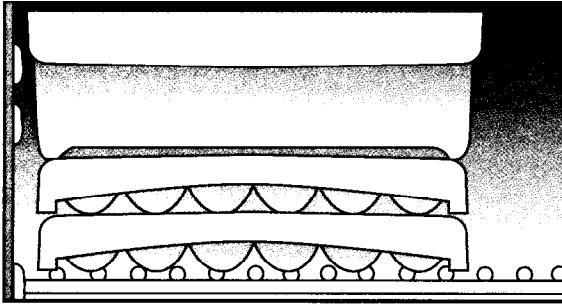

## Dispenser Models

### Automatic Ice Maker

After your refrigerator has been connected to the water supply, move the wire lever arm into the down position. This will start its operation. The ice maker will fill with water when the freezer reaches the proper temperature. It may be 8 to 12 hours before the ice maker furnishes any usable ice cubes.

Discard all the cubes from the first two or three batches made. These initial ice cubes may be irregularly shaped, discolored, or contain impurities from the new water supply piping.

When the ice cubes are ejected it is normal for several cubes to be joined together at the ends. They can easily be broken apart. The ice maker will continue to make ice until the supply of ice cubes raises the wire lever arm, shutting the ice maker off.

To manually stop the operation of the ice maker, move the wire lever arm into the up position.

Certain sounds may accompany the various cycles of the ice maker.

- buzzing of the water valve
- running of the water as the tray fills
- rattling of the ice cubes falling into an empty ice bin.

If the ice is not used frequently, the ice cubes will become cloudy, shrink, stick together and taste stale. Empty the ice storage bin periodically and wash it in lukewarm water. Be sure to dry the bin before replacing it or the ice cubes will stick to the metal auger.

To check the ice level or gain access to the ice bin, lift open the door on the ice bin.

To remove the bin, first turn off the ice maker. This is done by opening the door on the ice bin and moving the ice maker wire lever up to the "off" position. Then reach under the bin front and pull down on the back edge. After it snaps free, pull the bin straight forward. To replace the ice bin, align the bottom rails to the corresponding shelf grooves and push it straight back until it stops and latches. Make sure the tabs, at the back of the bin, that turn the spiral auger are positioned between the prongs from the auger motor. Turn the ice maker on by lowering the wire arm.

Beverages and foods should **not** be placed in the ice storage bin for quick chilling. These items can block the wire lever arm, causing the ice maker to malfunction.

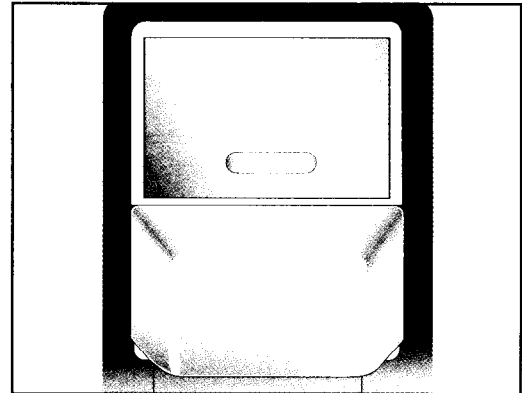

### For Your Safety

Do not place fingers or hands on the automatic ice making mechanism while the refrigerator is plugged in. This will help protect you from possible injury. It will also prevent interference with moving parts of the ejector mechanism and the heating element that releases the cubes.

Under certain rare circumstances, ice cubes may be discolored, usually appearing with a green-bluish hue. The cause of this unusual discoloration is apparently a combination of factors such as certain characteristics of local waters, household plumbing and the accumulation of copper salts in an inactive water supply line which feeds the ice maker.

Continued consumption of such discolored ice cubes may be injurious to health. If such discoloration is observed, discard the ice cubes and contact your dealer from whom the refrigerator was purchased.

# 13 Ice and Water Service

## Automatic Ice and Water Dispenser (certain models)

### Dispensing Water and Ice

To dispense ice or water, position a glass against the top portion of the actuator pad and press. Hold the glass high in the dispenser opening to avoid spills.

To stop dispensing, release the pressure on the actuator pad and hold the container in position momentarily to catch the last pieces of ice or the last drops of water. The ice delivery door will remain open for a short time. When it closes, a closing sound can be heard.

The control key pads are located on the dispenser control panel. To select the desired function, press the appropriate pad. When ice cubes, crushed ice or water are selected, a light above the selection glows.

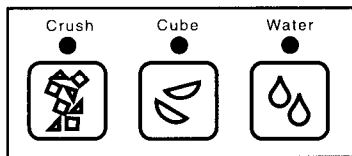

Water from the dispenser is not as cold as ice water. For colder water, simply add ice before dispensing the water. The first glass or two of water dispensed each time may be warmer than subsequent glasses. A full glass of water will be cooler than a partial glass. To prevent splashing, fill the glass with ice before adding water.

**NOTE:** When using the ice dispenser for the first time, discard the first two or three dozen cubes. When using the water dispenser for the first time, press the actuator pad for 10 minutes to bleed the air from the water line. Discard the first five to six glasses of water dispensed. This will insure pure and fresh water for drinking.

### Spill Tray

Do not pour water into the grille at the bottom of the dispenser area. This is a spill area, NOT a drain. Normal, small spills will evaporate. Larger spills should be wiped up with a soft cloth or sponge. The grille slides out for clean up. It is recommended to clean the spill area occasionally to prevent mineral deposits.

### Dispenser Light

When the actuator pad is pressed, the dispenser light automatically illuminates. To manually turn the light on, press the  pad.

To turn the light off, press the pad again.

### Dispenser Lock

To interrupt power to the water and ice dispenser so it cannot be used, press the  pad 3 times within 10 seconds.

An indicator light above the lock pad is illuminated when the dispenser is locked. Press the pad 3 times within 10 seconds again to unlock the ice and water service.

### Water Filter Change Reminder (select models)

This feature monitors the life of the PuriClean™ Filter. The light on the dispenser pad will illuminate after a filter has filtered for 12 months, or 416 gallons (whichever happens first). When the light illuminates, replace the filter and manually reset the control light.



**To reset the control light:** Press and hold the Dispenser Light and Lock key pads on the dispenser control panel for 3 seconds until the light flashes. At this point, release the keys and the control will be reset for another 12 months or 416 gallons.

**NOTE:** Water Filter Change Reminder light will operate even if filter bypass is in place.

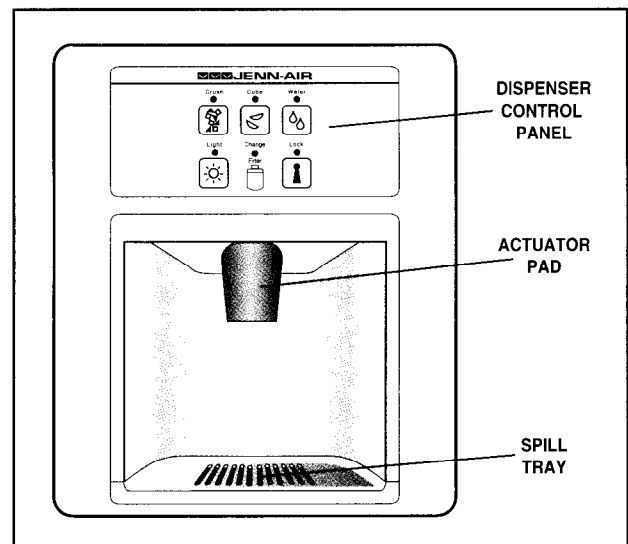

## Ice Dispensing Tips

- Some crushed ice may be dispensed even though cubed ice was selected. This happens occasionally when a few cubes are accidentally channeled into the crusher.
- Likewise, when changing from crushed ice to cubes, some crushed ice may be dispensed. This may also happen if irregular sized cubes or ice chips are in the storage bin.
- If the ice dispenser is not used frequently, ice cubes may clump together and may need to be broken apart or discarded.
- A slight pause may be noticed when dispensing crushed ice. This is normal because the ice is being channeled to

the crusher. Crushed ice pieces will vary in size and shape.

- Do not add ice to the storage bin which was not produced by your ice maker, it may not crush and/or dispense properly.
- Avoid operating the ice dispenser continuously for more than five minutes. Simply remove large quantities from the bin by hand.
- Avoid dispensing ice directly into fine china or delicate crystal. The pressure of pressing against the actuator pad and the ice dropping into the container can cause cracking or chipping of delicate items.

## Water Filter (select models)

The water filter mounts in the upper fresh food compartment, on the underside of the Twin Fresh™ control housing. **Change the filter cartridge every year**, or sooner, if the water flow to the dispenser or icemaker decidedly decreases, if an objectionable taste or odor returns or the water filter change reminder illuminates.

Your refrigerator was delivered from the factory with a filter bypass in place. The filter cartridge can be found packaged inside of the refrigerator. It can be easily installed without using any additional parts, screws or fasteners.

**Note:** The ice and water dispenser and the icemaker should not be operated unless either the filter bypass or a filter is in place.

## Special Notices

It is essential that operation, maintenance and filter replacement requirements be carried out as scheduled. This product is for cold water use only.

Do not use with water that is microbiologically unsafe, or of unknown quality without adequate disinfection before or after the system. Systems certified for cyst reduction may be used on disinfected water that may contain filterable cysts.

For your own knowledge and safety, it is recommended that your water quality be periodically tested. This information also identifies the optimal replacement filter choice for your refrigerator.

The contaminants or other substances removed or reduced by this water treatment system are not necessarily in your water.

The feed water connection must conform to applicable plumbing codes.

## Initial Filter Cartridge Installation

**Note:** Leave the refrigerator door open while removing and installing filters or plugs; this will prevent water from flowing through the system and running into the fresh food compartment.

1. Twist the cap of the filter bypass 1/4 turn counter-clockwise (as viewed from the bottom) so the ears on the plug can disengage. Remove the filter bypass from the filter head apparatus.
2. Carefully remove the filter from its packaging.
3. Apply the month sticker to the cartridge as a reminder to replace the filter within a year.
4. Remove the red cap from the filter.
5. Lubricate the O-ring with food grade vegetable oil.
6. Line up the cartridge ears so it can be inserted into the filter head. The unlocked symbol will line up with the indicator line that is molded into the light shield area. Rotate the cartridge into the head. Twist the cartridge 1/4 turn clockwise to lock it into place. You will feel a stop and the locked symbol should now be lined up with the indicator line.
7. Dispense water through the dispenser for 10 minutes.
8. Carefully check for leaks.

**Note:** A newly installed water filter cartridge may cause water to temporarily spurt from the dispenser

# 15 Water Filter

## Replacing the Filter Cartridge

**Note:** Leave the refrigerator door open while removing and installing filters or plugs; this will prevent water from flowing through the system and running into the fresh food compartment.

1. Twist the filter cartridge 1/4 turn counterclockwise (as viewed from the bottom) so that ears on the cartridge are able to disengage from the head. The unlocked symbol will be lined up with the indicator line that is molded into the light shield area. Twist gently until the cartridge is free from the head, but **DO NOT** pull. Avoid tipping the cartridge to prevent spillage. Dispose of the used cartridge.
2. Carefully remove the replacement filter from its packaging. (Read the label carefully to be sure you have the correct replacement filter cartridge).
3. Follow steps 3 through 8 under Initial Filter Cartridge Installation. (See page 14).

**Note:** A newly-installed water filter cartridge may cause water to temporarily spurt from the dispenser.

## Periods of Non-Use

If the refrigerator has been out of use for more than 2 weeks (ie: placed in storage or has been moved) the filter should be replaced when the refrigerator is put back into service.

## Replacement Filter Cartridges

For replacement filter cartridges or for service, contact your local dealer or Maytag Appliances Sales Company, Jenn-Air Customer Assistance, 1-800-688-1100:

## Replacement Filter Model Number:

UKF7002AXX - Taste, odor, chlorine, cysts, and lead

**Note:** Filter life may be affected by abnormal feed water conditions or unusual incidents such as hydrant flushes, reservoir turnover, or varying local water conditions.

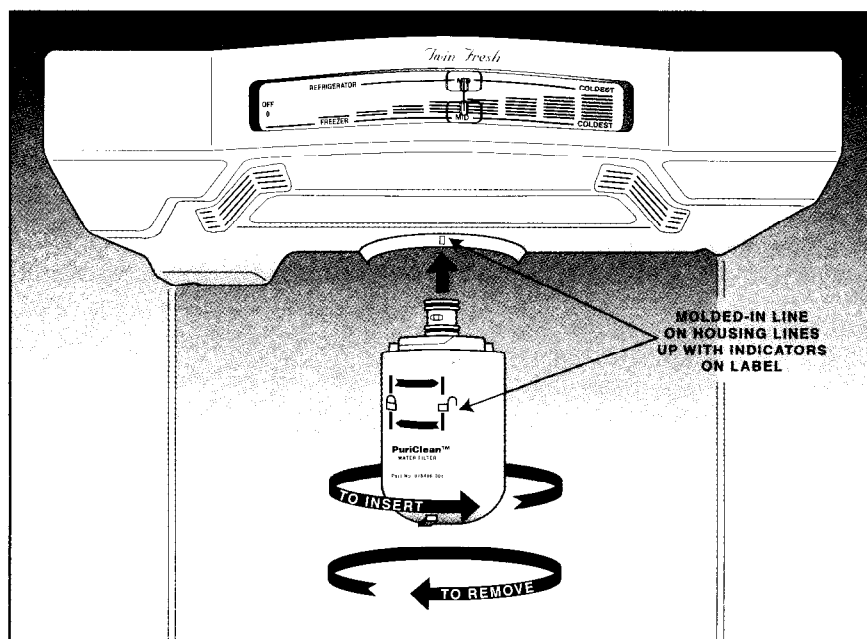



The PuriClean™ Water Filter is manufactured for Maytag Appliances by:

Cuno Incorporated  
 400 Research Parkway  
 Meriden, CT 06450

Rated Flow: .5 gpm (1.9 L)  
 Min. Op. Temp: 33° F (.6° C)  
 Max. Op. Temp: 100° F (38° C)  
 Min. Op. Press: 30 psi (207 KPa)  
 Max. Op. Press: 125psi (862 KPa)

The filter listed below has been tested and certified to NSF International under ANSI/NSF Standards 42 and 53 for the reduction of impurities as indicated:	
	<b>UKF7002AXX</b>
Taste/Odor	Yes
Chlorine Class 1 Std.42	Yes
Turbidity Std.53	Yes
Particulate Std. 42	Yes (Class I)
Cyst Std. 53	Yes
Lead Std. 53	Yes
Capacity	416 gal. (1574 L)
Function	Chemical/ Mechanical

See accompanying Product Data Sheet for further information on the filter.



# 17 Refrigerator Cleaning Chart

**⚠ CAUTION:** Disconnect the power cord before cleaning. Do not touch refrigerated surfaces with wet or damp hands. Damp objects stick to cold metal surfaces. Before cleaning the freezer, allow it to warm up. Allow glass shelves to warm up before immersing in warm water.

## Refrigerator Cleaning Chart

REFRIGERATOR EXTERIOR		
Part	Cleaning Agents	Tips and Precautions
Base grille	Soap and water Mild liquid sprays Vacuum cleaner attachment	
No Clean™ Commercial-Duty Condenser	Cleaning Brush (Part No. 20001017) Available from your dealer.	No need for cleaning unless environment is particularly greasy, dusty or there is significant pet traffic in the home.
Door handles	Soap and water Mild liquid sprays	
Painted metal surfaces: Cabinet, doors	Soap and water Mild liquid sprays	Dry with a clean, soft cloth. Do not wipe the refrigerator with a soiled dishwashing cloth or wet towel. These may leave residue that can scratch and weaken the paint. Do not use scouring pads, powdered cleansers, bleach or cleaners containing bleach. These products can scratch and erode the paint finish. Do not wax plastic or vinyl parts.
Stainless steel doors (certain models)	<b>Light cleaning:</b> mild detergent and water or a solution of white vinegar and water. <b>Moderate soil:</b> Bon Ami®. <b>Discoloration:</b> Cameo Stainless Steel Cleaner*.	Use a soft cloth or sponge. Always wipe with the grain of the stainless steel. Do not use chlorine bleach or any cleaning product that contains chlorine bleach. After cleaning, rinse and dry. To restore luster and remove streaks follow with Stainless Steel Magic Spray* (Jenn-Air model A912, Part No. 20000008).
REFRIGERATOR & FREEZER INTERIOR		
Door gasket	Baking soda and water Soap and water	Use 1-2 tablespoons baking soda per quart of water. Be sure to wring out excess water from sponge or cloth when cleaning around controls, lights, or electrical parts.
Glass shelves	Soap and water Glass cleaner Mild liquid sprays	<b>Allow the glass to warm up to room temperature before immersing in warm water.</b> Never use hot water.
Interior and door liner	Soap and water Baking soda and water	See above for baking soda solution. <b>DO NOT</b> use abrasive cleaners, concentrated detergents, bleaches, cleaning waxes, solvents or polish cleaners to clean the refrigerator interior.
Drawers, bins, egg cradle, etc.	Soap and water	<b>DO NOT</b> wash in an automatic dishwasher.
Automatic Humidity Control mesh/vent area	Water only	Wipe with a clean, damp cloth. Do not clean with any product containing chlorine bleach.

\*Brand names are the trademarks of the respective manufacturer.

## Cleaning Under the Refrigerator

Your refrigerator can be rolled out for cleaning the floor underneath. Raise the leveling feet if engaged (see page 3). Pull the refrigerator straight out from the wall.

## Vacations

If you will be gone for a month or less, leave the controls at the usual settings.

During longer absences:

- a) remove all food,
- b) shut off the ice maker (if installed) and the valve where you tapped into the water line to supply the refrigerator,
- c) disconnect the refrigerator from the electrical outlet,
- d) remove the filter cartridge (certain models) and install the filter bypass (see page 14-15). Dispose of the used

cartridge. A new cartridge can be installed when the refrigerator is put back in service.

**Note:** Disconnecting power to the refrigerator will suspend the 12 month countdown for the water filter change reminder (select models).

- e) clean and dry the refrigerator thoroughly,
- f) leave the doors open to prevent odors.

## Moving

When moving, follow steps a–f under Vacations. In addition, remove and carefully pack any items that are easily removable. Ship the refrigerator in an upright position with the doors taped shut.

## Replacing a Light Bulb

**CAUTION:** Disconnect the power cord before replacing light bulb(s). Wear gloves as protection against possible broken glass.

**Always use a standard 40 or 60 watt appliance bulb when replacing a fresh food or freezer compartment bulb.**

### Refrigerator

There are two light bulbs located at the top of the refrigerator compartment, on the underside of the Twin Fresh™ control housing.

To replace a lightbulb(s), remove the control cover from the control housing:

- grasp the control cover at the two rear “finger tabs”. These are located at the upper rear of the fresh food compartment, behind the light shields.
- pull down slightly to clear the retainer tabs and slide the cover forward until it is free.
- replace the bulb(s) with a 60-watt, standard base appliance bulb(s).
- After replacing the bulb(s), align the control cover on to the ribs on the control housing and slide it straight back until it snaps onto the retainer tabs.

On certain models, there is an additional light located behind the top drawer. To replace:

- remove the top drawer and cover as explained on page 10.
- carefully reach into the bulb cover and unscrew the lightbulb.
- replace the bulb with a 60-watt appliance bulb.

### Freezer

The freezer light is located on the back wall of the freezer compartment.

To replace:

- unhook the tabs on the top of the light shield by pressing in with the thumb on the center top of the light shield.
- pivot the shield down.
- unscrew the bulb when cool and replace it with a standard 40-watt appliance bulb.
- replace the bulb cover by pivoting it back into place and snapping the tabs into the appropriate slots.

### Dispenser Light (dispenser models only)

To replace:

- Locate the lightbulb in the dispenser area to the left of the actuator.
- Unscrew the used bulb and remove.
- Replace the bulb, using a 120V, 7-watt bulb.

# 19 Food Storage Tips

---

## Fresh Food Storage

- The fresh food compartment of a refrigerator should be kept between 34°F and 40°F with an optimum temperature of 37°F. To check the temperature, place an appliance thermometer in a glass of water and place in the center of the refrigerator. Check after 24 hours. If the temperature is above 40°F adjust the controls as explained on page 5.
- Avoid overcrowding the refrigerator shelves. This reduces the circulation of air around the food and results in uneven cooling.

## Fruit and Vegetables

- Store in the crisper drawers to help preserve the fruit and vegetable quality for longer time periods. (Refer to page 10).
- Sort fruits and vegetables before storage and use bruised or soft items first. Discard those showing signs of decay.
- Always wrap odorous foods such as onions and cabbage so the odor does not transfer to other foods.
- While vegetables need a certain amount of moisture to remain fresh, too much moisture can shorten storage times (especially lettuce). Drain vegetables well before storing.

## Meat and Cheese

- Raw meat and poultry should be wrapped securely so leakage and contamination of other foods or surfaces does not occur.
- Occasionally mold will develop on the surface of hard cheeses (Swiss, Cheddar, Parmesan). Cut off at least an inch around and below the moldy area. Keep your knife or instrument out of the mold itself. The remaining cheese will be safe and flavorful to eat. Do **NOT** try to save individual cheese slices, soft cheese, cottage cheese, cream, sour cream or yogurt when mold appears.

## Dairy Food

- Most dairy foods such as milk, yogurt, sour cream and cottage cheese have freshness dates on their cartons for appropriate length of storage. Store these foods in the original carton and refrigerate immediately after purchasing and each use.

## Frozen Food Storage

- The freezer compartment of a refrigerator should be kept at approximately 0°F or lower. To check the temperature, place an appliance thermometer between the frozen packages and check after 24 hours. If the temperature is above 0°F, adjust the control as described on page 5.
- A freezer operates more efficiently when it is at least two-thirds full.

## Packaging Foods for Freezing

- To minimize dehydration and quality deterioration use aluminum foil, freezer wrap, freezer bags or airtight containers. Force as much air out of the packages as possible and be sure they are tightly sealed. Trapped air can cause the food to dry out, change color and develop an off-flavor (freezer burn).
- Overwrap fresh meats and poultry with suitable freezer wrap prior to freezing.
- **Do not refreeze meat that has completely thawed.**

## Loading the Freezer

- Avoid adding too much warm food to the freezer at one time. This overloads the freezer, slows the rate of freezing and can raise the temperature of frozen foods.
- Leave space between the packages so cold air can circulate freely, allowing food to freeze as quickly as possible.
- Avoid storing hard-to-freeze foods such as ice cream and orange juice on the freezer door shelves. These foods are best stored in the freezer interior where the temperature varies less with door openings.

**Refer to the Food Storage Chart on page 20 for approximate storage times.**



**Food Storage Chart** (Storage times are approximate and may vary depending on type of packaging, storage temperature, and the quality of the food when purchased.)

<b>Foods</b>	<b>Refrigerator</b>	<b>Freezer</b>	<b>Storage Tips</b>
<b>DAIRY PRODUCTS</b>			
Butter	1 month	6-9 months	Wrap tightly or cover.
Milk & cream	1 week	Not recommended	Check carton date. Close tightly. Don't return unused portions to original container. Don't freeze cream unless whipped.
Cream cheese, cheese spread & cheese food	1-2 weeks	Not recommended	Wrap tightly.
Cottage cheese	3-5 days	Not recommended	Store in original carton. Check carton date.
Sour cream	10 days		
Hard cheese (Swiss, Cheddar & Parmesan)	1-2 months	4-6 months May become crumbly	Wrap tightly. Cut off any mold.
<b>EGGS</b>			
Eggs in the shell.	3 weeks	Not recommended	Refrigerate small ends down.
Leftover yolks or whites	2-4 days	9-12 months	For each cup of yolks to be frozen, add 1 tsp. sugar for use in sweet, or 1 tsp. salt for non-sweet dishes.
<b>FRUIT</b>			
Apples	1 month	8 months (cooked)	May also store unripe or hard apples at 60-70°F.
Bananas	2-4 days	6 months (whole/peeled)	Ripen at room temperature before refrigerating. Bananas & avocados darken when refrigerated.
Pears, plums, avocados	3-4 days	Not recommended	
Berries, cherries, apricots	2-3 days	6 months	
Grapes	3-5 days	1 month (whole)	
Citrus fruits	1-2 weeks	Not recommended	May also store at 60-70°F. If refrigerated, store uncovered.
Pineapples, cut	2-3 days	6-12 months	Will not ripen after purchase. Use quickly.
<b>VEGETABLES</b>			
Asparagus	1-2 days	8-10 months	Don't wash before refrigerating. Store in crisper.
Brussels sprouts, broccoli, cauliflower, green peas, lima beans, peppers	3-5 days	8-10 months	Wrap odorous foods. Leave peas in pods. Store in crisper.
Cabbage, celery	1-2 weeks	10-12 months	Wrap odorous foods & refrigerate in crisper.
Carrots, parsnips, beets, & turnips	7-10 days	8-10 months	Remove tops. Wrap odorous foods & refrigerate in the crisper.
Lettuce	7-10 days	Not recommended	Store in crisper.
<b>POULTRY &amp; FISH</b>			
Chicken and Turkey, whole	1-2 days	12 months	Keep in original packaging for refrigeration. When freezing longer than 2 weeks, overwrap with freezer wrap.
Chicken and Turkey, pieces	1-2 days	9 months	
Fish	1-2 days	2-6 months	
<b>MEATS</b>			
Bacon	7 days	1 month	
Beef or lamb, ground	1-2 days	3-4 months	Fresh meats can be kept in original packaging for refrigeration. Place in the Meat and Cheese Drawer. When freezing longer than 2 weeks, overwrap with freezer wrap.
Beef or lamb, roast & steak	3-5 days	6-9 months	
Ham, fully cooked, whole	7 days	1-2 months	
half	5 days	1-2 months	
slices	3 days	1-2 months	
Luncheon meat	3-5 days	1-2 months	Unopened, vacuum-packed luncheon meat may be kept up to 2 weeks in the Meat and Cheese Drawer.
Pork, roast	3-5 days	4-6 months	
Pork, chops	3-5 days	4 months	
Sausage, ground	1-2 days	1-2 months	
Sausage, smoked	7 days	1-2 months	
Veal	3-5 days	4-6 months	
Frankfurters	7 days	1 month	Processed meats should be tightly wrapped and stored in the Meat and Cheese Drawer.

Sources: United States Department of Agriculture; Food Marketing Institute; Cooperative Extension Service, Iowa State University

# Before You Call

## CHECK THESE POINTS IF YOUR REFRIGERATOR...

<b>Won't run</b>	<ul style="list-style-type: none"> <li>• the temperature control turned to "Off"</li> <li>• the power cord not plugged in</li> <li>• no power at the electrical outlet</li> <li>• the circuit breaker tripped or the house fuse blown</li> <li>• refrigerator is in automatic defrost</li> </ul>
<b>Runs too long/ too frequently</b>	<ul style="list-style-type: none"> <li>• modern refrigerators are larger and run colder, which requires more running time to provide more stable temperatures</li> <li>• prolonged door openings</li> <li>• the base grille blocked</li> <li>• too many door openings</li> <li>• the door not sealing (due to a package or a container holding door open)</li> </ul>
<b>Noisy operation</b>	<ul style="list-style-type: none"> <li>• the cabinet not level</li> <li>• a weak floor</li> </ul>
<b>Odor in cabinet</b>	<ul style="list-style-type: none"> <li>• odor producing foods should be covered or wrapped</li> <li>• the interior needs cleaning</li> </ul>
<b>Warm air from cabinet bottom</b>	<ul style="list-style-type: none"> <li>• normal air flow for condenser circulation</li> </ul>
<b>Cabinet vibrates</b>	<ul style="list-style-type: none"> <li>• the cabinet not level</li> <li>• a weak floor</li> </ul>
<b>Moisture on inside cabinet walls</b>	<ul style="list-style-type: none"> <li>• can occur during hot, humid weather with frequent or prolonged door openings</li> <li>• door not closed properly</li> </ul>
<b>Excessive moisture in crisper</b>	<ul style="list-style-type: none"> <li>• food not wrapped properly</li> <li>• hot, humid weather</li> </ul>
<b>Foods dry out (fresh or frozen)</b>	<ul style="list-style-type: none"> <li>• the packages not wrapped or sealed properly</li> <li>• the crisper not tightly closed</li> <li>• temperature control set too cold</li> </ul>
<b>Cabinet light not working</b>	<ul style="list-style-type: none"> <li>• the bulb burned out</li> <li>• no power at the outlet</li> </ul>
<b>Refrigerator compartment too warm</b>	<ul style="list-style-type: none"> <li>• the refrigerator control set too warm</li> <li>• prolonged door openings</li> </ul>
<b>Refrigerator compartment too cold</b>	<ul style="list-style-type: none"> <li>• the refrigerator control set too cold</li> </ul>
<b>Freezer compartment too warm</b>	<ul style="list-style-type: none"> <li>• the freezer control set too warm</li> <li>• prolonged door openings</li> </ul>
<b>Sizzling sound in freezer</b>	<ul style="list-style-type: none"> <li>• a normal sound caused by defrost water dripping on defrost mechanism</li> </ul>
<b>Visible glow in the freezer vents</b>	<ul style="list-style-type: none"> <li>• the appearance of a red glow or reflection is normal during the defrost cycle</li> </ul>
<b>Freezer not freezing properly</b>	<ul style="list-style-type: none"> <li>• products with high sugar content may not harden completely when frozen (ice cream, concentrated juice, etc.)</li> <li>• adjust freezer control to a colder setting</li> </ul>
<b>Water Filter Change Reminder light (select models) comes on when the filter bypass is in place</b>	<ul style="list-style-type: none"> <li>• This is normal. The control will count down 12 months or 416 gallons whether the filter or the filter bypass is in place. Reset the light (see pg. 13)</li> </ul>
<b>Ice cubes evaporate</b>	<ul style="list-style-type: none"> <li>• cold air moving over the ice cubes causes shrinkage, especially with limited usage. This is normal.</li> </ul>
<b>Automatic ice maker not operating</b>	<ul style="list-style-type: none"> <li>• the stop arm in OFF (up) position</li> <li>• the water supply turned off</li> <li>• the water pressure too low</li> <li>• the freezer too warm</li> </ul>
<b>Front cabinet surface warm to the touch</b>	<ul style="list-style-type: none"> <li>• Special design to limit condensation during periods of high humidity.</li> </ul>
<b>Ice dispenser not operating</b>	<ul style="list-style-type: none"> <li>• ice jam in the dispenser</li> <li>• ice maker not operating</li> <li>• lock switch on</li> </ul>
<b>Water dispenser not operating</b>	<ul style="list-style-type: none"> <li>• water supply turned off</li> <li>• water pressure too low</li> <li>• lock switch on</li> </ul>

Note: For further assistance contact Maytag Appliances Sales Company, Jenn-Air Customer Assistance: 1-800-688-1100

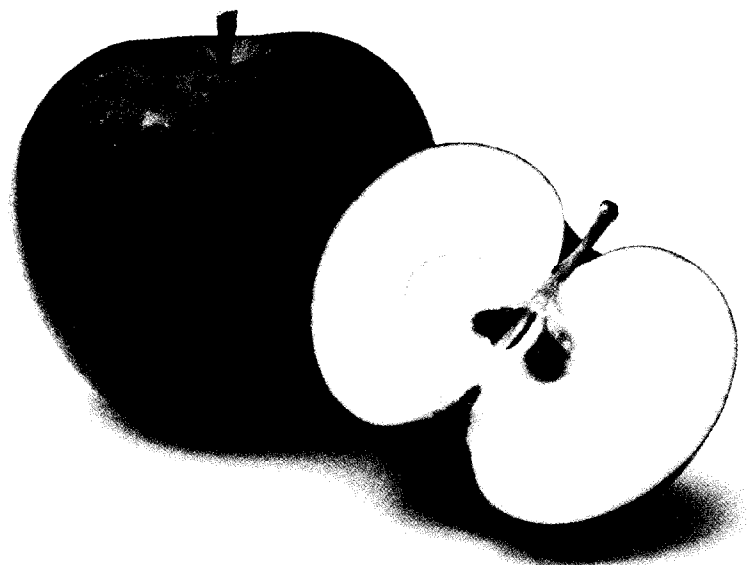

# 23 Refrigerator Warranty

## Full One Year Warranty

For **one (1) year** from the date of original retail purchase, any part which fails in normal home use will be repaired or replaced free of charge. Ice Maker – when purchased with the refrigerator and installed by the dealer the ice maker will be considered part of the refrigerator for warranty purposes.

## Limited Warranty — Major Refrigeration Components

### Second thru Fifth Year:

After the first year from the date of original retail purchase, through the end of the fifth year, Maytag Appliances will repair or replace, at its option, free of charge for parts and labor, any part of the sealed refrigeration system (consisting of the compressor, evaporator, condenser, drier and connecting tubing) and the cabinet liner (exclusive of the door liner) which fail in normal home use. Mileage and transportation charges, if required, shall be the responsibility of the owner.

## Limited Warranty — PuriClean™ Water Filter:

With regard to the water filter cartridge, Maytag Appliances will replace any part of the water filter cartridge which fails due to a defect in workmanship or materials, *for a period of Thirty Days from the date of original purchase*. This is a full 30 day warranty, and during this warranty period we will also provide free of charge, all labor and in-home service required to replace the defective part.

## Limited Warranty — Other Parts:

### Second Year:

Parts other than major refrigeration components which fail in normal home use during the second year following the date of original retail purchase will be repaired or provided free of charge for the part itself, with the owner paying all other costs, including labor, mileage and transportation.

**Please note:** The full warranty and the limited warranties apply when the refrigerator is located in the United States or Canada. Refrigerators located elsewhere are covered by the limited warranties only including parts that fail during the first year.

## LIMITATIONS OF LIABILITY

The warrantor shall not be liable for any incidental or consequential damages, including food loss. Some states do not allow the exclusion or limitation of consequential damages, so the above limitation or exclusion may not apply to you.

**The specific warranties expressed above are the ONLY warranties provided by the manufacturer. This warranty gives you specific legal rights, and you may also have other rights that vary from state to state.**

## To Receive Warranty Service

To locate an authorized service company in your area contact the Jenn-Air dealer from whom your appliance was purchased; or call Maytag Appliances Sales Company, Jenn-Air Customer Assistance at the number listed below. Should you not receive satisfactory warranty service, please call or write:

Maytag Appliances Sales Company  
Attn: CAIR® Center  
P.O. Box 2370  
Cleveland, TN 37320-2370  
**U.S. and CANADA 1-800-688-1100**  
**U.S. customers using TTY for deaf, hearing impaired or speech impaired, call 1-800-688-2080.**

**NOTE:** When writing about an unsolved service problem, please include the following information:

- (a) Your name, address and telephone number;
- (b) Model number, serial number, and revision number (found on the top front interior of the refrigerator compartment);
- (c) Name and address of your dealer and the date the appliance was bought;
- (d) A clear description of the problem you are having.
- (e) Proof of purchase (sales receipt).

## What Is Not Covered By These Warranties:

1. Conditions and damages resulting from any of the following:
  - a. Improper installation, delivery, or maintenance.
  - b. Any repair, modification, alteration or adjustment not authorized by the manufacturer or an authorized servicer.
  - c. Misuse, abuse, accidents, or unreasonable use.
  - d. Incorrect electric current, voltage or supply.
  - e. Improper setting of any control.
2. Warranties are void if the original serial numbers have been removed, altered, or cannot be readily determined.
3. Light bulbs.
4. Products purchased for commercial or industrial use.
5. The cost of service or service call to:
  - a. Correct installation errors.
  - b. Instruct the user on proper use of the product.
  - c. Transport the appliance to the servicer.
6. Consequential or incidental damages sustained by any person as a result of any breach of these warranties.

Some states do not allow the exclusion or limitation of consequential or incidental damages, so the above exclusion may not apply.

User's Guides, service manuals and parts catalogs are available from Maytag Appliances Sales Company, Maytag Customer Assistance.

**Jenn-Air • 403 West Fourth Street North • P.O. Box 39 • Newton, Iowa 50208**



## Free Manuals Download Website

<http://myh66.com>

<http://usermanuals.us>

<http://www.somanuals.com>

<http://www.4manuals.cc>

<http://www.manual-lib.com>

<http://www.404manual.com>

<http://www.luxmanual.com>

<http://aubethermostatmanual.com>

Golf course search by state

<http://golfingnear.com>

Email search by domain

<http://emailbydomain.com>

Auto manuals search

<http://auto.somanuals.com>

TV manuals search

<http://tv.somanuals.com>