

JENSEN®

How to Install and Operate the XA4150 Amplifier

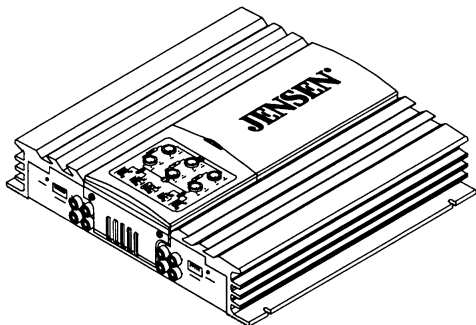

Welcome!

What you're holding in your hands is no ordinary owner's manual. We've tried to make the instructions in this book clear and easy to follow.

For your Jensen amplifier to work right, it must be installed correctly. This manual will show you how to install your new amplifier like a pro. It's a good idea to read all of these instructions before you begin the installation. Most installations are straightforward and can be handled by a do-it-yourselfer with the right tools, patience, and the ability to follow instructions. But, do-it-yourself installation isn't for everyone. If you still don't feel confident after reading this book, consider turning the installation job over to someone better suited to it.

Warranty Service

If your Jensen amplifier should ever require service, you will need to have the original dated receipt. If you ever need to return the unit for any reason, always include the receipt with the product.



Technical Assistance

For technical assistance with the operation or installation of the XA4150, call 1-800-323-0221.

Contents

Features	2
Installation	2
Before You Begin	2
Installation	2
Amplifier Location	2
Disconnect Battery	2
• Amplifier Installation Kit	2
Supplies and Tools Needed	3
Routing Wires	3
• Bigger is Better	3
Wiring	4
Power and Outputs	4
Power Terminal (BATT +12V)	4
Ground Terminal (GND)	4
Remote Terminal (RMT +12V)	4
Fuses	4
Inputs and Controls	5
Input Wiring	5
Pass Output	5
Power Light	5
Protect Light	5
Input Level Control	6
Bass Boost	6
Crossover	6
Speaker Wiring	7
Testing	9
Reconnect Battery	9
Test Power Wiring	9
Test Speaker Connections	9
• Dealing with Alternator Noise	9
• Installing in Trunk	10
• Crimp Connections	10
• Securing Wires	10
• Speaker and Power Wires	10
Troubleshooting	11
Specifications and Warranty	12

Features

The Jensen XA4150 power amplifier is a four-channel 600-watt total system power automotive amplifier. The XA4150 includes:

- RCA inputs
- High level inputs
- Continuously variable low pass or high pass crossover
- Bass boost feature
- Remote turn on/off
- Electronic protection circuitry to protect the amplifier from short circuit, DC offset and thermal overload
- Unique, super-efficient heat sink design
- **4 x 75 watts RMS per channel** (4 x 150 watts peak)
- 2 x 200 watts RMS bridged into a 4 ohm load

- Bridgeable design to direct full power to two speakers

Audio Amplifiers

Amplification offers two advantages:

- The XA4150 amplifier can make the sound of your receiver fuller and richer, even at low volume levels.
- Many automotive receivers provide four to 10 watts at maximum power. At 75 watts RMS per channel (200 watts bridged), the XA4150 can be played substantially louder, permitting the use of more powerful speakers.



Installation

Before You Begin Installation

Before you begin, you will need tools, supplies and adapters. It is best to make sure you have everything you need before you start. There is a list of supplies and tools on the next page.

Amplifier Location

Important

Allow air circulation around the amplifier.

The XA4150 amplifier's compact design allows greater flexibility in mounting. It can be mounted under a seat or in the trunk.

When selecting a location, remember that amplifiers generate heat. Select a location where air can circulate around the amplifier. Do not cover the XA4150 with carpets or enclose it behind interior trim panels. Do not mount the amplifier in an inverted or upside down configuration. Every installation will be a bit different based upon vehicle design. Check all locations and placements carefully before making any cuts or connections.

Disconnect Battery

Before you begin, always disconnect the battery negative terminal.

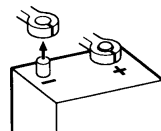

Important

If wiring connections are made wrong, the unit will not operate properly and it could be damaged. Follow the installation instructions carefully, or have the installation handled by an experienced technician.

Professional Tip

Amplifier Installation Kit

Your installation job will be much easier if you purchase an amplifier installation kit. These kits often include low-level RCA cables, extra large power and ground wires, a fuse or circuit breaker and connector for the battery.

Supplies and Tools Needed

Supplies:

- Speaker wire (12 gauge for subwoofers, 16-18 gauge for other speakers)
- Sheet metal type screws for mounting amplifier
- Electrical tape
- Solderless crimp connectors
- 1/2" thick plywood or particle board to mount amplifier on

Tools:

- Flat and Phillips screwdrivers
- Wire cutters
- Wire strippers
- Cordless or standard electric drill and drill bit set
- Crimping tool (if using solderless crimp connectors)
- 12-volt test light or digital multimeter
- Wire brush or scraper (to remove paint for a good ground connection to vehicle)
- Soldering iron and rosin core solder (if you're going to solder your connections)

Amplifier Installation Kit:

You will need an amplifier installation kit to install your amp properly because it contains all the wire and connectors that you will need to hook up your new amp right the first time. If you want to purchase these items separately you will need the following:

- 20-25 feet of 8 gauge wire
- 50 amp fuse or circuit breaker (to be hooked up at the battery)
- 20 feet of 18 gauge wire for the remote turn-on/power antenna lead
- RCA cable (for signal input from radio)
 - 20 feet for trunk installation
 - 12 feet for under-seat installation
- Two 8 gauge ring terminals (one for the battery connection and the other for the ground connection at the amp). You may need two additional ring terminals if you are using a circuit breaker at the battery.
- Two 8 gauge barrel connectors (you may need these depending on what type of fuse holder you have)
- Two 8 gauge spade terminals (to hook up power at the amp)
- Eight 12 gauge spade terminals for subwoofers or 16-18 gauge spade terminals for other speaker connections to amp
- One 18 gauge spade terminal for remote turn-on/power antenna lead

Routing Wires

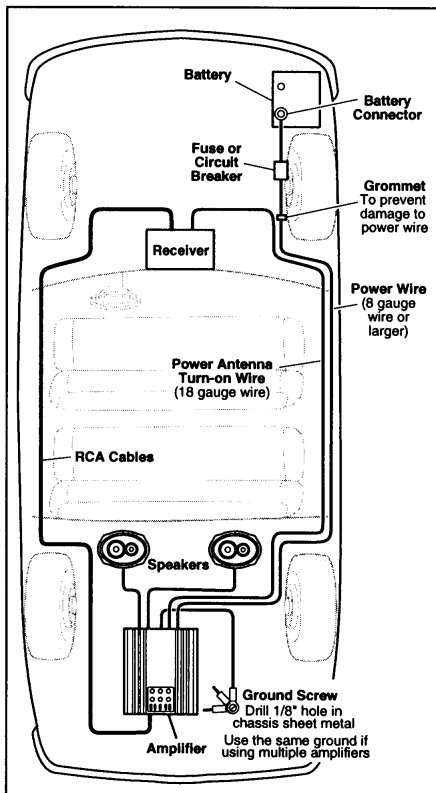

Professional Tip

Bigger is better

Stereo installation dealers sell extra thick power and speaker wires to ensure best sound. Look for 8 gauge power wire, especially if you have several amplifiers.

Wiring

Power and Outputs

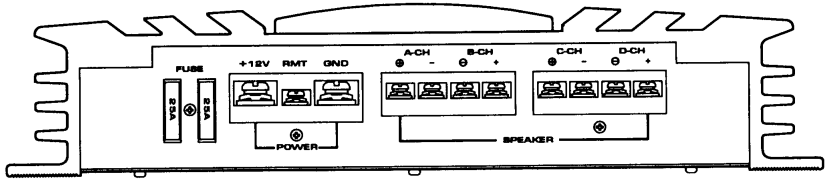

Power Terminal (BATT +12V)

Connect directly to the vehicle battery+ terminal with 8 gauge wire (minimum).

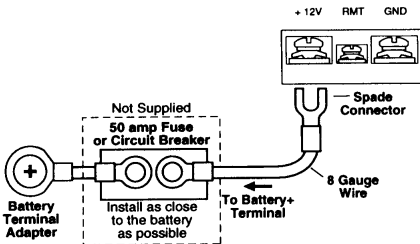

Remote Terminal (RMT +12V)

Connect the radio power antenna lead from the receiver to the amplifier remote (RMT) terminal. This turns the amplifier on whenever the receiver is turned on. If a power antenna lead is not available, connect this wire to the radio or accessory fuse.

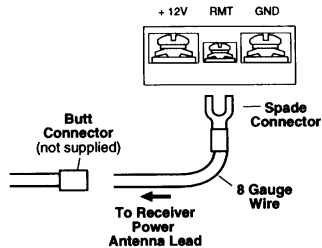

Ground Terminal (GND)

Connect to a good chassis ground. The ground connection should be to clean, unpainted metal to provide a good electrical connection.

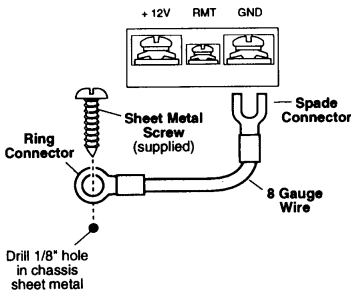

Fuses

Use only two 25 amp blade-type fuses.

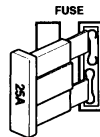

Inputs and Controls

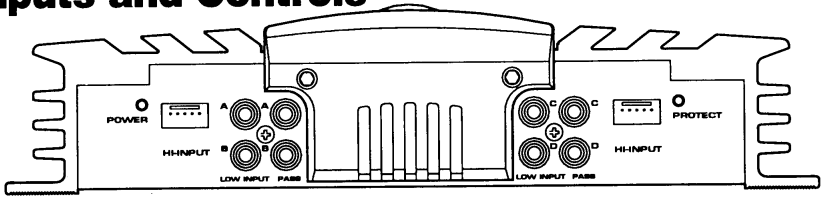

Input Wiring

Inputs may be high level (from the receiver's speaker) or low level (from special low level outputs). Low level input is preferred for best performance.

Important

Use only the low level or high level input, do not use both at one time.

Low Level Input

Use a pair of shielded stereo audio cables with RCA type jacks. Most trunk-mount amplifier installations require 20-foot RCA cables. Most under-seat and pickup truck installations use 12-foot cables.



Connect RCA cables from your receiver to the RCA input jacks on the amplifier.

High Level Input

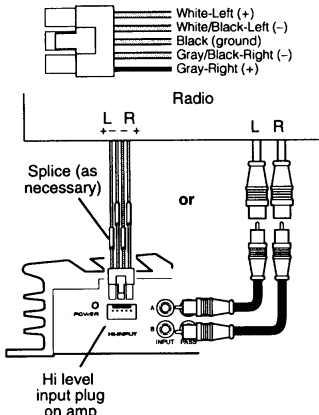
Connect left and right speaker wires coming from radio to high level input plug as shown.



Pass Output

-  Use pass through (PASS OUTPUT) connectors for adding other amplifiers.
-  PASS

Power Light

-  The power light comes on when 12 volt power is available at both the battery +12 volt and RMT wires.

Protect Light

-  The red protect light comes on when the amplifier shuts down from overheating or a short circuit (speaker failure).

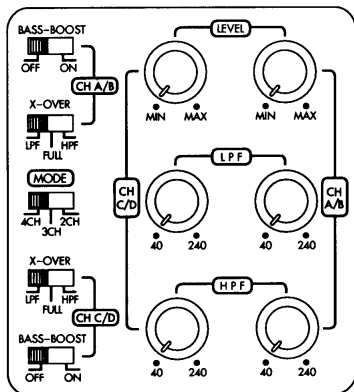

Input Level Control

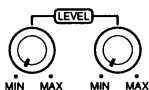

The input level control matches the output of your radio to the input of the amplifier. After the installation is complete, make sure the input level control on the amp is turned down all the way (counterclockwise or all the way to the left). Play a tape or CD (make sure bass and treble settings or EQ are flat too) and turn the volume up slowly until you just start to hear distortion. Now back the volume down just a bit. On the amp, slowly turn up the input level control (clockwise or to the right) until you just start to hear distortion and back it down a bit. Now your radio and amplifier levels are matched.

Bass Boost



BASS BOOST increases the volume of bass by up to 6 dB at 45Hz.

Crossover

Adjust the crossover to accommodate your chosen installation method.

- **L.P.F.**—(low pass filter) only bass tones go to speakers. Use with woofers or subwoofer.
- **FULL**—all tones go to speakers. Use with full-range speakers.
- **H.P.F.**—(high pass filter) blocks very low tones from the speakers. Use with 6" or smaller speakers.

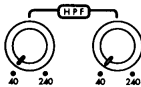
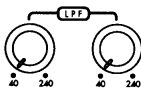

Use **L.P.F.** and **H.P.F.** to adjust from 40 to 240Hz.

When using your Jensen amplifier to run a subwoofer and two full-range speakers (known as Tri-mode or three channel operation) you will need to purchase separate high and low

pass crossovers from your local retailer. A pair of high pass crossovers for your full range speakers and a low pass filter for the subwoofer. This will allow the amplifier to work properly when installing it in Tri-mode. Failure to install these filters may damage your amplifier and/or your speakers.

Speaker Wiring

The XA4150 amplifier has inputs and outputs for four channels

4 Speakers

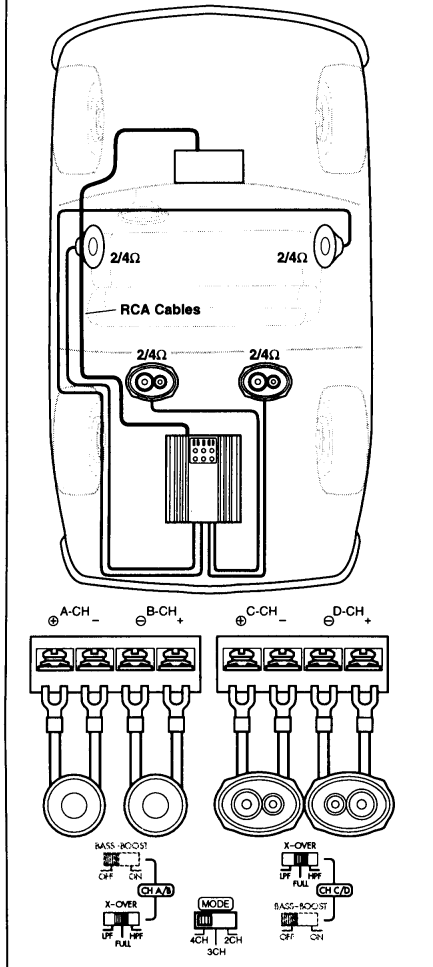

2 Subwoofers/Bridged Mono

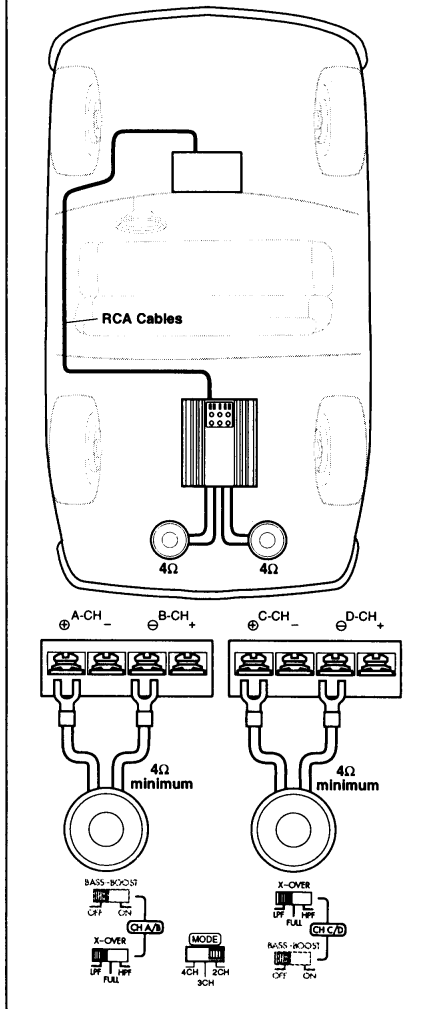

2 Speakers + Bridged Subwoofer

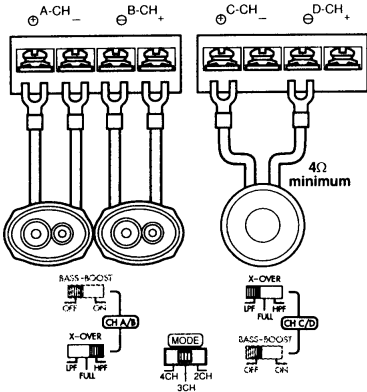
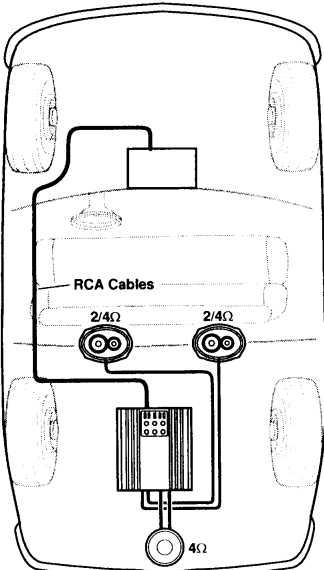

4 Speakers + 2 Subwoofers

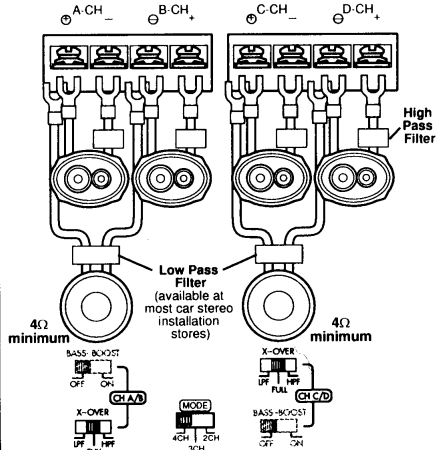
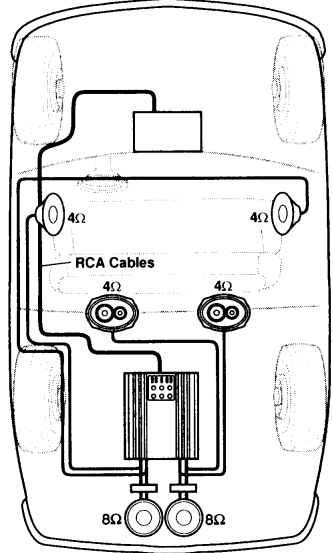

Important

When running a subwoofer and two full-range speakers together (Tri-mode operation), high and low pass filters must be used. Failure to install these filters will damage your amp and/or speakers.

Testing

Before you finish the installation, you should do the following tests to make sure the wiring is correct and everything is operating properly.

Reconnect Battery

When wiring is complete, reconnect the battery negative terminal.

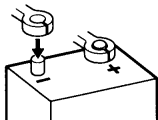

Test Power Wiring

1. Turn on the receiver but do not turn up the volume. The amplifier power light should come on. If not, check the RMT and +12V wires.
2. Turn up the receiver volume slightly. All speakers should operate. If not, check wiring connections at amplifier and speakers.

Test Speaker Connections

These tests make sure the speakers are connected right. If speakers don't play at all, one (or both) speaker wires may be disconnected. If the wrong speaker plays (you hear left speaker when you expect right speaker) make sure you connected the wires correctly.

Once everything is operating correctly, reassemble vehicle trim and dashboard.

Professional Tip

Dealing with Alternator Noise

The vehicle alternator can cause a "siren" sound in the speakers that changes with engine speed. To prevent alternator noise:

- Do not bundle RCA cables with speaker or power wires
- Do not run speaker wires parallel to power wires
- If you have more than one amplifier, connect all ground wires to the same screw
- Make sure all wires are as short as possible
- Make sure the receiver black wire has a good connection to the vehicle chassis ground

Professional Tip

Installing in Trunk

When installing the amplifier in the trunk, run the power wires along the same path as the other vehicle wiring. Many cars have insulated channels for wiring. You will have to remove the door sill trim and the carpet.

Professional Tip

Crimp Connections

Purchase crimp connectors and crimping tool. Connectors are color coded.

1. Strip 1/4 inch (6mm) of insulation from both wires.
2. Insert into connector.
3. Crimp tightly.

You can make permanent splices (using butt connectors) or select connectors that can be removed and reinstalled.

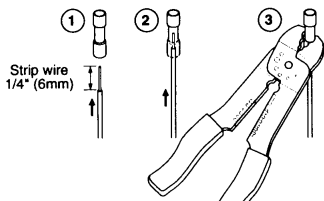

Professional Tip

Securing Wires

Be proud of your installation! Use wire ties to bundle wires together when possible. (But never bundle speaker wires and power wires together!)



Secure loose wires to the vehicle to make sure they don't rub or rattle.

Professional Tip

Speaker and Power Wires

Do not run speaker and power wires next to each other. Power wires can generate a "siren" sound in the speakers. Run speaker and power wires on opposite sides of the car.



Troubleshooting

Problem	Possible Cause	Corrective Action
Amplifier does not operate (power LED not on) when vehicle and radio are on	No power to +12V terminal	Repair wire or connections
	No power to remote wire with radio on	Check connections to radio with test light
	Fuse blown	Check fuse
Radio volume needs to be turned up too high for amp to work	Input level control (gain control) adjusted too low	Adjust input level control (gain control)
Radio volume is too sensitive	Input level control adjusted too high	Adjust input level control to lower setting
Sound from only one speaker	Defective speaker	Replace speaker
	Poor connections to speaker (wire)	Check connections
	Speaker wires shorting together	Separate speaker wires and insulate
	RCA input cable defective	Replace cable
Sound distorted	Input level control adjusted too high	Adjust input level control
Blows fuses	Speaker wires shorting together	Separate speaker wires and insulate
	Power wires hooked up incorrectly	Check power wire connections
	Speakers blown or defective	Check speakers
Alternator whine in outputs (vehicle ignition noise)	Radio has poor noise immunity	Disconnect audio inputs to amplifier – if noise disappears then the radio is at fault
	Improper ground connections	Make sure radio and amplifier are grounded to the same point
Loud pop in speakers when power is turned on or off	Remote wire (blue) not properly connected	Refer to page 4 for proper installation. If radio does not have a power antenna lead and you have connected the remote lead to an ignition source then you may get a "pop" in your speakers. This is not uncommon. You may have to put a switch in line with the remote lead to turn the amp on/off manually.
Protect light comes on/ amplifier shuts down	Amp is in thermal protection	Let amp cool down before attempting to turn back on (some installations may require a fan to keep the amp cool, especially if you are driving subwoofers with the amp)
	Faulty speaker connection and/or crossover	Check speakers and/or crossovers for loose or bad connections
	Low battery voltage	Make sure you are getting between 10.8-15.6 volts to the amplifier with a digital multimeter measured at the amplifier
	Speaker impedance less than 2 ohms per channel	If you are using 4 ohm speakers you cannot have more than two speakers wired in parallel per channel Amp will not operate into 2 ohms bridged
No output on channels	Speaker wires not connected to speakers properly	Refer to pages 5, 6 and 7 for proper installation
	Input hooked up incorrectly	
Can't find cause of problem		Contact Jensen Technical Assistance (1-800-323-0221)

Free Manuals Download Website

<http://myh66.com>

<http://usermanuals.us>

<http://www.somanuals.com>

<http://www.4manuals.cc>

<http://www.manual-lib.com>

<http://www.404manual.com>

<http://www.luxmanual.com>

<http://aubethermostatmanual.com>

Golf course search by state

<http://golfingnear.com>

Email search by domain

<http://emailbydomain.com>

Auto manuals search

<http://auto.somanuals.com>

TV manuals search

<http://tv.somanuals.com>