

Safety Precautions:

1. Ensure the plug is securely plugged into the main socket before operating the unit.
2. Ensure the Voltage on the main socket is the same as specified on the unit.
3. Use parts only manufactured by the unit manufacturers.
4. Ensure the battery is correctly installed before using the unit.

In case of the following emergencies, remove plug from the main socket immediately:

1. Plug or cables are damaged.
2. Any form of foreign objects dropped inside the enclosure.
3. Unit is being exposed to rain and/or water.
4. Unit unable to operate under normal operation.

Notices:

1. The changes or modifications not expressly approved by the party responsible for compliance could void the user's authority to operate the equipment.
2. To comply with the FCC RF exposure compliance requirements, no change to the antenna or the device is permitted. Any change to the antenna or the device could result in the device exceeding the RF exposure requirements and void user's authority to operate the device.

This device complies with part 15 of the FCC RULES. Operations is subject to the following two conditions:

- (1) This device may not cause harmful interference and
- (2) This device must accept any interference received, including interference that may cause undesirable operation.



CAUTION
RISK OF ELECTRIC SHOCK
DO NOT OPEN



The lightning flash with Arrowhead Symbol within an equilateral triangle is intended to alert the user to the presence of "uninsulated" "dangerous voltage" within the product's enclosure that may be of sufficient magnitude to constitute a risk of electric shock to persons.



The exclamation point within an equilateral triangle is intended to alert the user to the presence of important operating and maintenance (servicing) instructions in the literature accompanying the appliance.

CAUTION: TO REDUCE THE RISK OF ELECTRIC SHOCK, DO NOT REMOVE COVER (OR BACK). NO USER-SERVICEABLE PARTS INSIDE. REFER SERVICING TO QUALIFIED SERVICE PERSONNEL.

CONTENTS:

1. INTRODUCTION	
Overview	01
Product Specifications	02
Contents/Accessories	03
2. FRONT PANEL CONTROL	
Panel Control	04
Input/Output	04
3. REMOTE CONTROL FUNCTION	
Controls & Functions	05
4. INSTALLATION GUIDE	
When Connecting to a Coax Cable	06
Connecting to Other Equipment	07
Input (RCA) from other Equipment	07
Output (RCA) to Other AV Equipment	07
VGA Input	08
Connect Power	08
5. BASIC FUNCTIONS	
Power Signal	09
Mode(SOURCE)	09
Volume Setting	10
Channel Search	10
OSD Setting	10
Mute Setting	11
6. OSD SETTINGS	
TV Setting	12
AV1 Setting	14
AV2 Setting	15
DTV Setting	16
DTV Setting (Adjustment main-item)	17

CONTENTS:

DTV Setting (Brightness/Contrast/Saturation)	18
DTV Setting (Hue/SPDIF Output)	19
DTV Setting (Channel main-item)	20
DTV Setting (TV Source/Auto Program)	21
DTV Setting (Manual Program/Channel List)	22
DTV Setting (Favorite List)	23
DTV Setting (Closed Caption main-item/Caption)	24
DTV Setting (Service Type/options)	25
DTV Setting (V-chip main-item/V-Chip Lock)	26
DTV Setting (Parental Guide/MPAA Rating/Change PIN)	27
DTV Setting (Setup main-item)	28
DTV Setting (OSD Language/Time Zone)	29
DTV Setting (OSD Opacity/OSD Timeout/All Reset)	30
DTV Setting (System Info/Electronic Program Guide/ Audio Language/Video Freezing)	31
PC Adjust Setting	32
8. ANNEX A	
LCD Monitor Care & Cleaning Tips/Cleaning the LCD Monitor Cleaning the Enclosure	33
9. ANNEX B	
No Picture/Snowy Picture/Picture Flickers/No Sound/ Remote Control not Working/Unit will not power on w/front Power button	34
10. SPECIFICATIONS	35

1. INTRODUCTION:

Overview :

New technology in LCD monitors allows the enjoyment of a higher quality picture display and higher brightness; lighter in weight and slimmer body design, power saving capabilities and low radiation, giving you a safe, relaxing and environmental-friendly visual enjoyment.

Our product uses high quality original imported 15.4 inches 16:9 colored "Active Matrix TFT". The Active Matrix TFT high decoding capabilities enable display of complicated or high quality images, presenting a vivid visual reproduction and beautiful visual display. Incorporated with a user-friendly menu, allowing easy customization to user preferences.

The unit comes with built-in screen display controls when used with the remote control, allowing you to make changes to the settings. It even support the use of 2 channel wireless headphones, therefore you do not need to worry that the volume coming out from the monitor will disturb other people.



2. Product Specifications:

1. 15.4" Television / monitor for Mobile use
2. 12V DC Power
3. High Performance, 16:9 LCD Panel
4. High Brightness 500 nit
5. High contrast ratio 500:1
6. Ultra wide viewing angle 170 degrees
7. Front controls
8. Cable ready TV/DTV tuner
9. ATSC - HDTV Tuner
10. Closed Caption and V-Chip
11. High output speakers
10. Built in 2 Channel IR transmitter for optional wireless headphones
11. Wireless Night time viewable remote control included
12. Mounting bracket optional
13. Two auxiliary monitor inputs: One fixed NTSC composite, one selectable composite, S-Video or component (HDTV)

Contents/Accessories : (Please check the content of the Package.)

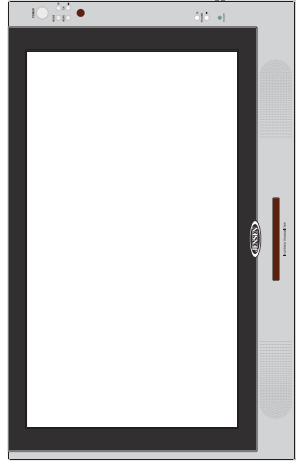

Monitor

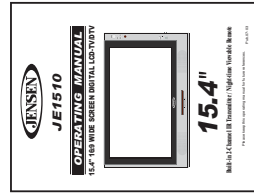

Operation Manual

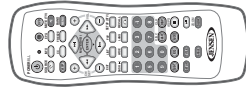

Remote Control



DC Power Harness 1



DC Power Harness 2



IR Transmitter Audio Input Harness



Antenna coax pigtail cable



Component Video Conversion Cable



Composite Video Conversion Cable

2.FRONT PANEL CONTROLS

PANEL CONTROL :

1. POWER : Power On/Off
2. MODE : Source Select
3. CHANNEL : Channel Select
4. MENU : Menu Setting
5. VOLUME ⊕ : Increase Volume
6. VOLUME ⊖ : Decrease Volume
7. SPEAKER : Loud Speaker
8. IR STEREO TRANSMITTER : For Wireless Headphone

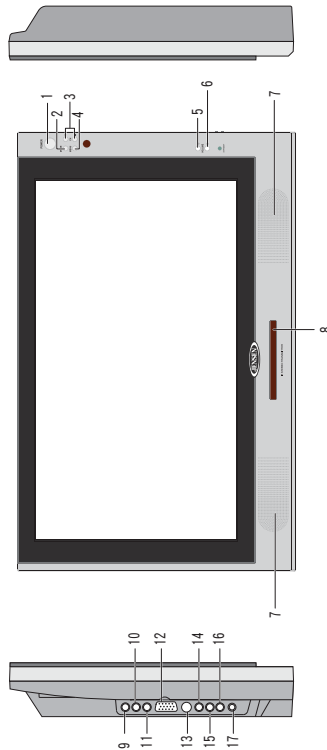

INPUT/OUTPUT :

9. AV Out 1 : RCA Video Output
10. AV Out 1 : RCA Left Audio Output
11. AV Out 1 : RCA Right Audio Output
12. VGA : VGA Input (Computer)
13. S-Video (AV) In 1 : S-Video Input /Component Input
14. AV In 2 : RCA Video Input
15. AV In 2 : RCA Left Audio Input
16. AV In 2 : RCA Right Audio Input
17. AV In 1 : AV 1 Audio Input
18. Antenna Input
19. Power Supply Socket
20. IR Transmitter (Channel 2) Audio Input (L/R)

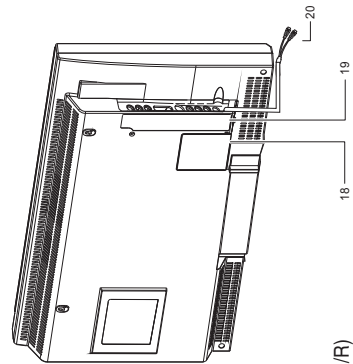

04

3. Remote Control Function :

(When using the remote control, point it towards the IR sensor.)

Battery Usage Caution:

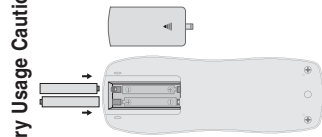

To prevent battery leakage which may result in bodily injury or damage to the remote :

1. Install all batteries correctly. ⊕ and ⊖ as marked on the remote control.
2. Do not mix batteries (OLD and NEW or CARBON and ALKALINE, etc.).
3. Remove batteries when the remote is not used for a long time.

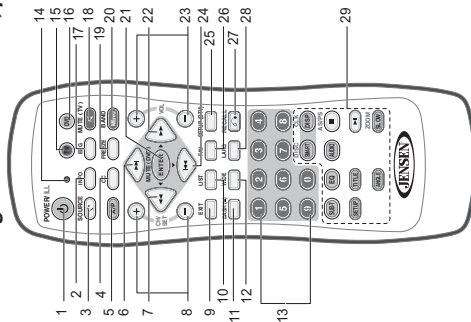

Note: 1. Some buttons on remote have three functions (for TV/DTV & DVD mode). When press the TV/DTV button, the remote will get into TV/DTV function mode, each time when press the TV/DTV function button, the LED will flash "RED" light. When in DVD Mode, each time when press the DVD function button, the LED will flash "GREEN" light.

2. Some of the buttons are designed for operate single disc DVD player. Please read the DVD manual to operate the DVD player.

TV Mode:

1. POWER : Power On/Off
2. SOURCE : Signal Button
5. AUTO PROGRAM : Channel Scanning
- 6./7./24./22. ▲/▼/▶/◀ :
Up, Down, Left, Right Button for setting
8. CH (+/-) : Channel Up/Channel Down
13. 1/2/3/4/5/6/7/8/9/0 : Numbers Button
14. LED : TV/DTV Mode --- Red Flash
: DVD Mode --- Green Flash
15. TV : TV Mode Selected
21. ENTER : Enter Button
23. VOLUME (+/-) : Volume Up/Volume Down
27. RECALL : Channel Return

DVD Mode:

6. NEXT TRACK (▶▶): Select Next Title/Chapter
7. FR (◀◀): FAST Reverse Play
16. DVD : DVD Mode Selected
22. FF (▶▶) : FAST Forward Play
20. MENU : DVD Root Menu
24. PREVIOUS TRACK (◀◀) : Select Previous Title/Chapter
29. DVD Button : Buttons only for DVD use

DTV (ATSC) Mode:

1. POWER : Power On/Off
2. INFO : Program information display
3. SOURCE : Signal Button
4. CC : Hoy key for closed caption function
5. AUTO PROGRAM : Channel Scanning
- 6./7./24./22. ▲/▼/▶/◀ :
Up, Down, Left, Right Button for setting
8. CH (+/-) : Channel Up/Channel Down
9. EXIT : Leave OSD function
10. LIST : Display the list of channels
11. DASH (-):Dash between major and minor number
12. WIDE : Full
13. 1/2/3/4/5/6/7/8/9/0 : Numbers Button
17. EPG : EPG function display
18. MUTE : Mute Button
19. FREEZE : Video image freeze / play
21. ENTER : Enter Button
23. VOLUME (+/-) : Volume Up/Volume Down
previous layer
25. SETUP (DTV) : Display OSE /Return to
previous layer
26. FAV : List all favorite programs
27. RECALL : Channel Return
28. LANG : Bilingual function

05

4. INSTALLATION GUIDE:

When Connecting to a Coax Cable:

Connect coax cable from your TV antenna or cable to coax pigtail on back of LCD TV.

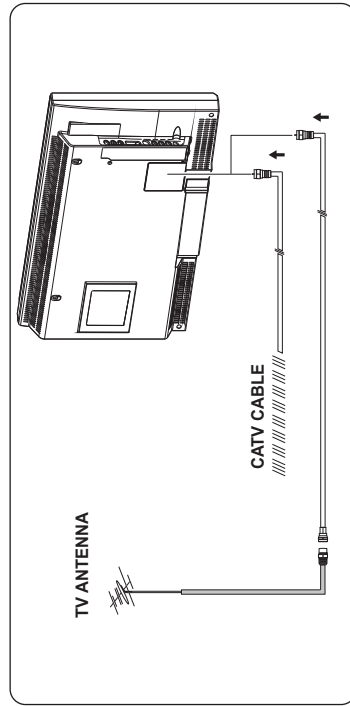

Connecting to Other Equipment (S-Video cable with optional)

1. This unit is able to support various input settings. You can connect your video recorder, amplifier, game console etc, to the unit, to enjoy high quality, digital audio-visual effect.
2. Connect AV equipment using S-Video. (photo.1)
3. Using the S-Video cable, connect your equipment to the S-Video/Component socket on the TV Side Input Panel.
4. Connect your AV cable to the equipment. (photo.2)

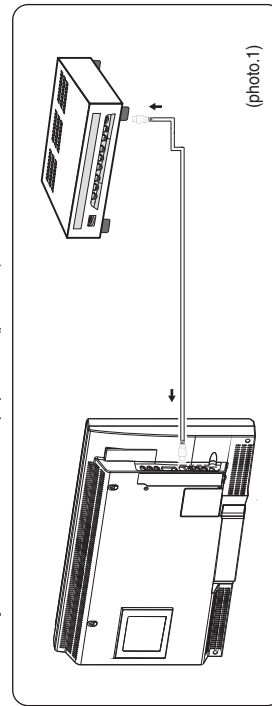

Noted: When connecting S-Video input, please set OSD (AV1 Select) to "S V" to view S-VIDEO source.

06

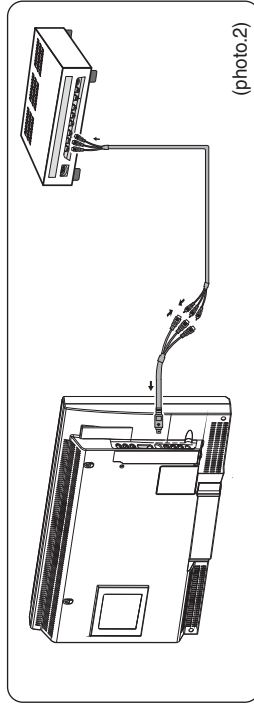

Noted: When connecting Component Video input, please set OSD (AV1 Select) to "CV" to view Component-Video source.

Input (RCA) from other Equipment:

Connect to the TV AV IN 2 socket.

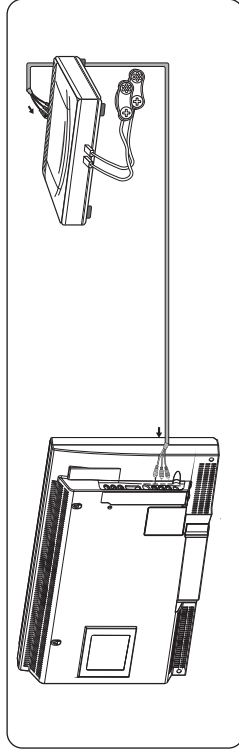

Noted: When connecting AV IN 2, please set OSD (AV1 Select) to "AV" to view AV IN 2 source.

Output (RCA) to other AV Equipment:

Output the AV Signal using the unit AV output socket.

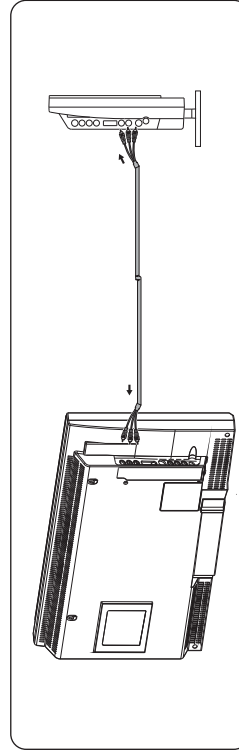

Noted: When connecting AV OUT 1, please set OSD (AV1 Select) to "AV" to view AV OUT 1 source.

07

*** VGA Input: (Optional VGA connection)**

This unit provides VGA (Computer) input connector.

1. Connect computer VGA output to the monitor VGA input.
2. To connect audio source, use audio cable to connect from computer audio output to VGA audio input.

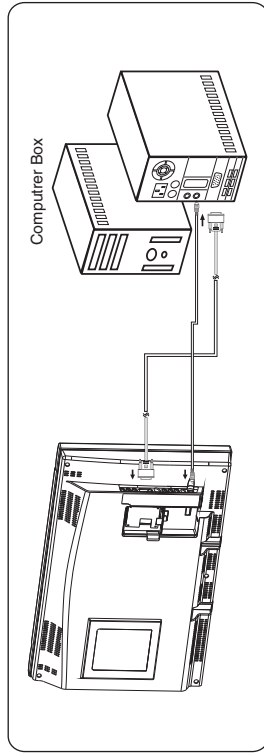

Noted: When connecting VGA input, please set OSD (AV1 Select) to "PC" to view VGA source.

Connect Power:

Connect to the power source using the power cable and adapter provided.

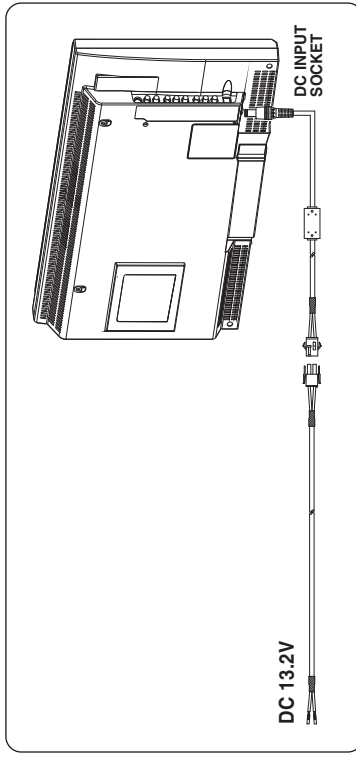

ATTENTION: Ensure the power supply is connected to the unit. When not using unit for a long period of time, remove DC input socket from the main power point.

5. Basic Functions :

*** POWER SIGNAL:**

When POWER indication LED on unit turns RED in color indicating power is connected.



*** MODE:**

1. Press the "Mode" button on the TV front panel or "SOURCE" button on remote control to select from the various mode settings.
2. The mode setting status will change each time the "Mode" or "SOURCE" button is pressed – "AV1/AV2/TV/DTV"

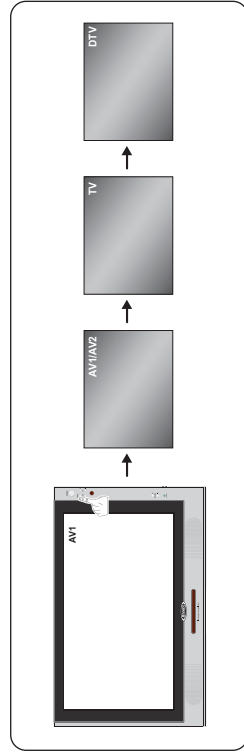

** Please make sure video source has been connected properly.

*** Volume Setting:**

1. Press "Volume +/-" (▲/▼) button on TV front control panel or remote control to adjust volume level.

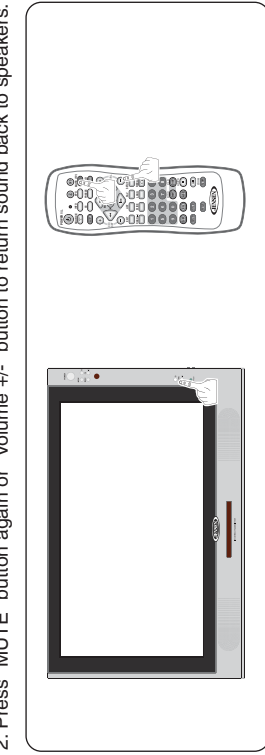
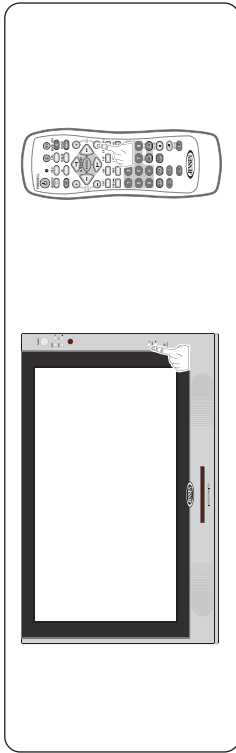

*** Mute:**

1. Press "MUTE" button on remote control to mute speakers. "MUTE" will display on screen.
2. Press "MUTE" button again or "Volume +/-" button to return sound back to speakers.

*** Channel Select:**

1. Press "Channel ▲/▼" button on remote control or TV Front Control Panel to change/select channels.
2. Press Number buttons on remote control to change/select channel directly.



*** OSD Menu Setting:**

This monitor provides an "OSD" setting, enables you to customize the setting for the monitor. Press "MENU" button on remote or front control panel to set OSD menu.

Note: Before adjusting settings, ensure all the video sources are in the correct mode.

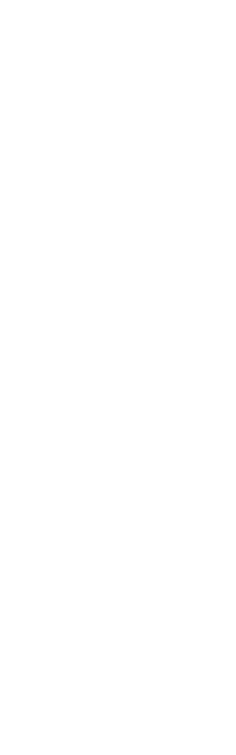

6. OSD Settings:

This TV provides an "OSD" setting that enables you to customize the monitor settings. Note: Before adjusting settings, ensure all the video sources are in the correct mode.

Management Setting :

Press "MENU" button, OSD menu will display on screen, press "SET" button to select "TV setting", and press "ENTER" button to enter management setting, then press "SET" button to select course settings. (Please see chart below.)

TV Setting :

Picture adjust was show yellowing bar to confirm your selection.

Audio Adjust

You can adjust the sound characteristics to your preference.

Input Select

To select the input signal "TV" mode by Main display of MODE button.

Zoom

The "Zoom" setup lets you select the internal FULL/NORMAL/14:9 or ZOOM.

AV1 Select

To select the input signal "AV" mode by AV1 Select of MODE button.

TV Setting :

Press "MENU" button, OSD menu will display on screen, press "SET" button to select "TV setting", and press "ENTER" button to enter TV setting, then press "SET" button to select course settings. (Please see chart below.)

MTS

Select "MTS" setup, and select STEREO/SAP/MONO to set speaker settings.

ANT/CATV

To select the input signal in IPC/HRC/CATV/ANT by TV Setting of MODE button.

Add/Erase

Menu or list operations are Add or Erase and the screen returns to the source screen.

Parental Control

To enable or disable captions or subtitles, select Parental Control and CAPTION.

Language

To change the on-screen display language, select OSD LANGUAGE.

6. OSD Settings:

This TV provides an "OSD" setting that enables you to customize the monitor settings. Note: Before adjusting settings, ensure all the video sources are in the correct mode.

Management Setting :

Press "MENU" button, OSD menu will display on screen, press "SET ▶/◀" button to select "AV1 setting", and press "ENTER" button to enter management setting, then press "SET▶/◀/▶/◀" select course settings. (Please see chart below)

AV1 Settings:

Picture adjust was show: yellow bar to confirm your selection.

You can adjust the sound characteristics to your preference.

To select the input signal "AV1" mode by Main display of MODE button.

The "Zoom" setup lets you select the internal FULL/NORMAL/14:9 or ZOOM.

To select the input signal "AV" mode by AV1 Select of MODE button.

To change the on-screen display language, select OSD LANGUAGE.

Menu or list operations are canceled and the screen returns to the source screen.

14

7. OSD Settings:

This TV provides an "OSD" setting that enables you to customize the monitor settings. Note: Before adjusting settings, ensure all the video sources are in the correct mode.

Management Setting :

Press "MENU" button, OSD menu will display on screen, press "SET ▶/◀" button to select "AV1 setting", and press "ENTER" button to enter management setting, then press "SET▶/◀/▶/◀" select course settings. (Please see chart below)

AV2 Settings:

Picture adjust was show: yellow bar to confirm your selection.

You can adjust the sound characteristics to your preference.

To select the input signal "AV2" mode by Main display of MODE button.

The "Zoom" setup lets you select the internal FULL/NORMAL/14:9 or ZOOM.

To select the input signal "AV" mode by AV1 Select of MODE button.

To change the on-screen display language, select OSD LANGUAGE.

Menu or list operations are canceled and the screen returns to the source screen.

15

6. OSD (DTV) Settings:

First time installation



OSD operation tip

There are five main items on the OSD menu and you can use ▲ / ▼ keys to select these main items. When you select specific main item, and then the related sub-items will be shown on monitor, please use ► keys and ▲ / ▼ keys to select sub-items. Almost all sub-items have sub-function; you can press **ENTER** key or ► key to enter specific sub-function, and then use

◀ / ► keys to switch sub- function. After your change, you can press **ENTER** key to see your setting or just press **MENU** key to return to sub-items OSD layer. Please refer to the following chapters in order so you can see how to operate our OSD menu.

16

OSD (DTV) Settings:

At this menu, you can adjust the level settings related to the picture on TV.

Sub-Item	Function description	Operation	Selection
Brightness:	To adjust the brightness level of picture on TV. (fig1.2)	► : increase the brightness level ◄ : decrease the brightness level	0 ~ 100
Contrast:	To adjust the contrast level of picture on TV. (fig1.3)	► : increase the contrast level ◄ : decrease the contrast level	0 ~ 100
Saturation:	To change the saturation level on TV. (fig1.4)	► : increase the saturation level ◄ : decrease the saturation level	0 ~ 100
Hue:	To change the tint level of picture on TV. (fig1.5)	► : increase the hue level ◄ : decrease the hue level	0 ~ 100
SPDIF Output:	To select digital audio output format. (fig1.6)	◄ / ► : functions select	Dolby / PCM / Off

Adjustment main-menu:

Using ► key and ▲ or ▼ key to select sub-items you want. Press **ENTER** key or ► key to enter its sub-function and press **MENU** key to return Adjustment main-menu.



17

OSD (DTV) Settings:

Brightness:

In this menu, you can adjust video brightness parameter from 0 to 100 which is increased / decreased at 1 with ◀ or ▶ key directly. The default number is 50.



Fig.1.2 Brightness menu

Contrast:

You can switch this sub-function with ◀ or ▶ key to adjust video contrast parameter from 0 to 100 increased / decreased at 1 directly. The default number is 50.

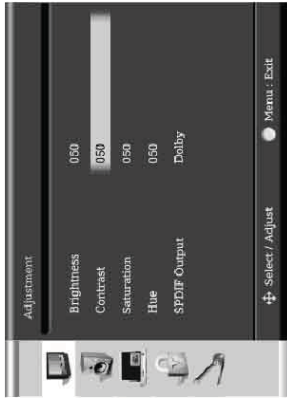

Fig.1.3 Contrast menu

Saturation:

The video saturation parameter can be adjusted from 0 to 100 and the level will be increased / decreased at 1 directly when you use ◀ or ▶ key. The default number is 50.



Fig.1.4 Saturation mode

OSD (DTV) Settings:

Hue:

The video hue parameter can be adjusted from 0 to 100 and the level will be increased / decreased at 1 directly when you use ◀ or ▶ key. The default number is 50.



Fig.1.5 Hue menu

SPDIF Output:

There are two kinds of digital audio output formats here to select. If your sound equipment supports digital audio output, you can select functions (Dolby / PCM) to perform with ◀ or ▶ key. Or mute works with Off function.



Fig.1.6 SPDIF Output menu

OSD (DTV) Settings:

At this menu , you can set TV system and scan the system you selected. (fig.2.1)

Sub-Item	Function description	Operation	Selection
TV Source:	To select the receiving mode of the TV source. (fig.2.2)	Enter key: to execute TV source function ◀ / ▶ : functions select	AIR/STD/HRC /IRC
Auto Program:	To select auto scan program mode here.(fig.2.3)	Enter key: to execute Auto Scan Function ◀ / ▶ : functions select	Digital
Manual Program:	To scan specific digital channel. (fig2.4)	▶ : increase the channel number ▶ : decrease the channel number Enter key: switch to the channel	AIR: CH 02-69 STD/HRC/IRC: CH 01-125
Channel List:	To show all digital channels system keeps. (fig.2.5)	▲ / ▼ : select the channel Enter key: switch to the channel FAV key: add in Favorite List	The listed channels
Favorite List:	To list the programs (DTV) you like. (fig.2.7)	▲ / ▼ : select the program Enter key : switch to the program	The programs Listed by user

Channel main -menu:

Using ▶ key and ▲ or ▼ key to select sub-items you want. Press ENTER key to the specific sub-function to switch and press MENU key to return Channel main-menu.(fig.2.1)



20

OSD (DTV) Settings:

TV Source:

You can select the receiving mode of the TV source (AIR / STD / HRC / IRC) with ENTER key and then the system will change the receiving frequency automatically according to your selection.



Fig.2.2 TV Source menu

Auto program:

By pressing the ENTER key or the SCAN key, the system will automatically program local stations into memory.



Fig.2.3 Auto program menu

OSD (DTV) Settings:

Manual program:

In this menu, you can select the channel from CH 02 ~ 69 in AIR (CH 01 ~ 125 in STD /HPC/IRC) with or key, and switch to the channel by pressing **ENTER** key. You also know the quality for the channel form SNR bar when you are selecting.

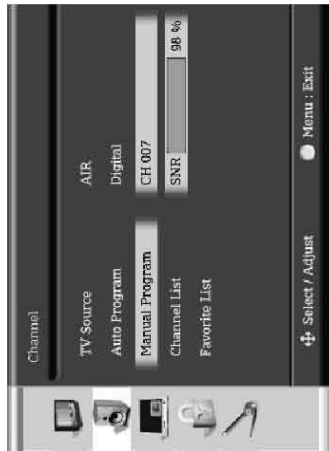

Fig.2.4 Manual program menu

Channel List:

In this menu, all of the programs are listed here and you can add the program you want to Favorite List as a favorite program by pressing **FAV** key. You may also use **▲** or **▼** key to switch to the program. It works with same function by pressing **LIST** key.

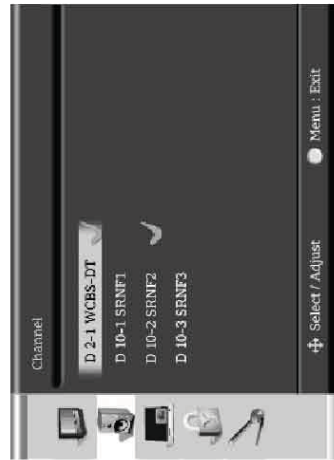

Fig.2.5 Channel List menu



Fig.2.6 Hot-key LIST

OSD (DTV) Settings:

Favorite List:

In this menu, you can see the favorite programs here which are selected in Channel List with **FAV** key (fig.2.5). You may also use **▲** or **▼** key to switch to the favorite programs; likewise you can show this function directly by pressing **FAV** key on remote.

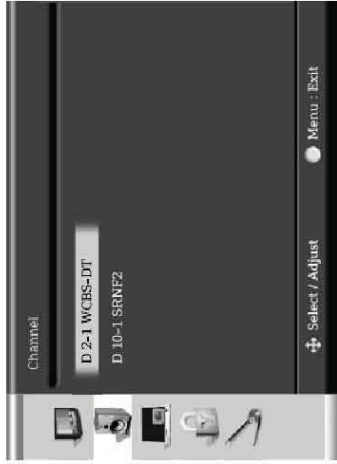

Fig.2.7 Favorite List menu



Fig.2.8 Hot-key FAV

OSD (DTV) Settings:

At this menu, you can set system options of digital closed caption. (fig3.1)

Sub-Item	Function description	Operation	Selection
Caption:	Set On/Off to switch on/off closed caption function. (fig3.2)	◀ / ▶ : functions select	On / Off / On-Mute
Service Type:	Digital closed caption (EIA-708/EIA-608) service selection. (fig3.3)	◀ / ▶ : functions select	Service1 ~ 6 CC1 ~ CC4
Options:	To select display options of digital closed caption (EIA-708 only). (fig3.4)	◀ / ▶ : functions select ▲ / ▼ : select the items in Options item	(fig3.5)



Closed Caption main-menu

There are three of sub-menu in this main-menu. Using ▶ key and ▲ or ▼ key to select sub-items you want. Press ENTER key or key to the sub-function to set function, or press ENTER key to return Closed Caption main-menu.



Fig.3.1 Closed Caption main-menu

Caption:

In this menu, you can select Close Caption display function with ◀ or ▶ key, and to activate it by pressing ENTER key. It includes one more On-Mute function. When system works at this mode, the system will show CC content when system mutes.

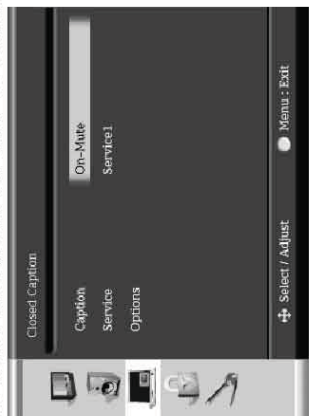

Fig.3.2 Caption menu

OSD (DTV) Settings:

Service Type:

If the program provides digital closed caption information, you can select Service1 ~ Service6 / CC1 ~ CC4 with ◀ or ▶ key and then Pressing ENTER key to activate.

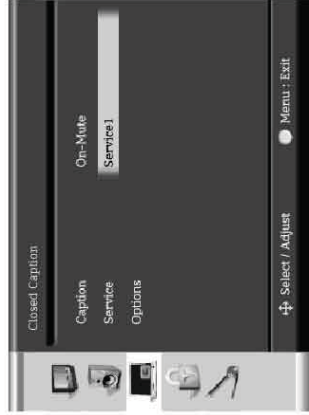

Fig.3.3 Service Type menu

Options:

I. In this menu, you can select the related items of Options item with ▲ or ▼ key. To press ENTER key or ▶ key to enter the sub-function to adjust specific functions for Closed Caption (EIA-708 only) or press MENU key to return Closed Caption main-menu.

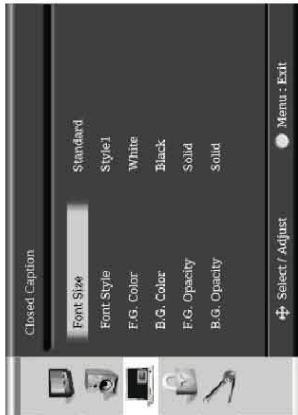

Fig.3.4 Options menu

II. You can select which functions you want with ◀ or ▶ key and then pressing ENTER key to execute the function, whereas SETUP(DTV) key both to return the Options item and to cancel the function you select.

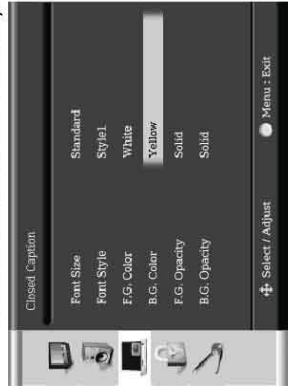

Fig.3.5 Options menu

Sub-Item of Options	Function
Font Size	Small / Standard / Large
Font Style	Style1 ~ Style7
F.G. Color	White / Black / Red Green / Blue / Cyan Yellow / Magenta
B.G. Color	White / Black / Red Green / Blue / Cyan Yellow / Magenta
F.G. Opacity	Solid / Transparent / Translucent
B.G. Opacity	Solid / Transparent / Translucent

OSD (DTV) Settings:

You have to input a correct PIN code before you can enter this item, and at this item, you can set system parameters of digital V-chip function. (fig4.1) (fig4.2)

Sub-Item	Function description	Operation	Selection
V-Chip Lock:	Enable / Disable V-Chip function. (fig4.3)	◀ / ▶ : functions select	On / Off
Parental Guide:	To set rating dimension of TV rating system. (fig4.4)	▲ / ▼ / ◀ / ▶ : select the choices for TV rating	TV-Y / TV-Y7 / TV-G / TV-PG / TV-14 / TV-MA
MPAA Rating:	To set rating dimension of movie rating system adopted by the Motion Picture Association of America. (fig4.5)	▲ / ▼ : select the choices for movie rating	N/A / G / PG / PG-13 / R / NC-17 / X
Change PIN:	To change system PIN code. (fig4.6)	Number key: input the PIN code	Number key(0~9)

V-chip main-menu:

Before enter to V-chip menu you will be requested to input a correct set of PIN code with number key (0 ~ 9) whose default system PIN code is "1234".

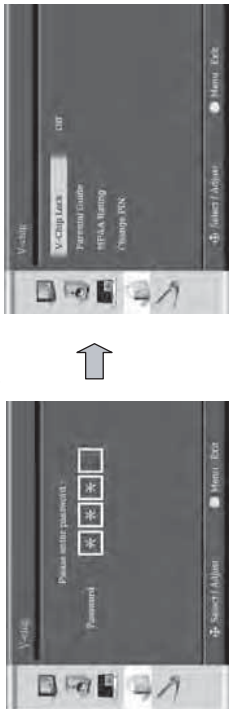

Fig.4.1 V-chip administration

Fig.4.2 V-chip main-menu

V-Chip Lock:

In this menu, you can set On/Off V-Chip channel blocking function with ◀ or ▶ key, ENTER key to execute.



Fig.4.3 V-chip Lock menu

OSD (DTV) Settings:

Parental Guide:

In this menu, you can set the program for TV rating in TV rating table to block with ▲, ▼, ◀ or ▶ key and then Press ENTER key to activate the function.

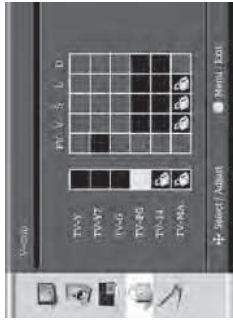

Fig.4.4 Parental Guide menu

MPAA Rating:

In this menu, you can set the program for movie rating which is listed in picture below to block with ▲ or ▼ key and then press ENTER key to activate.



Fig.4.5 MPAA Rating menu

Change PIN:

In this menu, you can change your PIN code with number key (0 ~ 9). It is necessary to input two times your new PIN code to confirm. It is invalid for the new PIN code to press MENU key during changing PIN code.



Fig.4.6 Change PIN menu

OSD (DTV) Settings:

This menu is for system operation setting, and the functions are as follows: **(fig5.1)**

Sub-item	Function description	Operation	Selection
OSD Language:	System provides three of OSD languages to select. (fig5.2)	◀ / ▶ : OSD language select	English / Spanish / French
Time Zone:	We provide 7 items for time zone selection. (fig5.3)	◀ / ▶ : the time zone select	Central / Mountain / Pacific / Alaska / Hawaii / Atlantic / Eastern
OSD Opacity:	To adjust the transparency of the OSD. (fig5.4)	◀ / ▶ : OSD Opacity select	0 ~ 100
OSD Timeout:	To adjust OSD timeout function. (fig5.5)	◀ / ▶ : OSD Timeout select	2sec / 4sec / 6sec
All Reset:	To reload system default setting. (fig5.6)	◀ / ▶ : select Yes or No	Yes / No
System Info.	System firmware version number.	—	—



Setup main-menu:

To select which sub-items you want with ▲ or ▼ key, press **ENTER** key or ▶ key to enter the sub-function to switch the functions and press **MENU** key to return back. **(fig5.1)**



Fig.5.1 Setup main-menu

OSD (DTV) Settings:

OSD Language:

In this menu, you can select OSD language with ◀ or ▶ key, and the system provides 3 languages (English / Spanish / French) to choose.

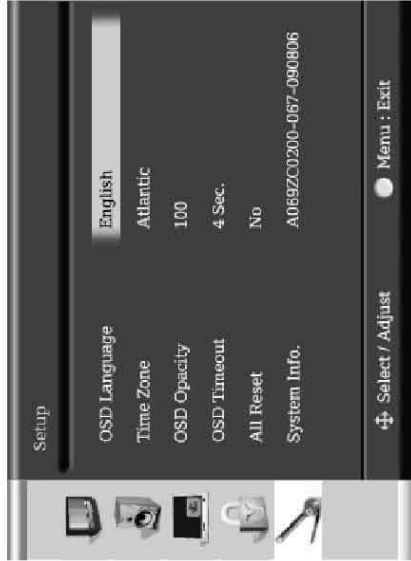

Fig.5.2 OSD Language menu

Time Zone:

In this menu, we provide 7 items for time zone (Central / Mountain / Pacific / Alaska / Hawaii / Atlantic / Eastern) to select with ◀ or ▶ and then press **ENTER** key to activate.



Fig.5.3 Time Zone menu

OSD (DTV) Settings:

OSD Opacity:

In this menu, the transparent level of OSD menu can be set by adjusting the Opacity parameter with ◀ or ▶ key directly.



Fig.5.4 OSD Opacity menu

OSD Timeout:

You can adjust the time (2sec/4sec/6sec) when the OSD menu appears on screen with ◀ or ▶ key and ENTER key.



Fig.5.5 OSD Timeout menu

All Reset:

Please use this function very carefully; the system will reload default setting if you execute this function with "Yes" selection.



Fig.5.6 All Reset menu

OSD (DTV) Settings:

Hot-key Introduction

System Info:

This information is for System firmware version.

Program Information:

This function is digital only. Press INFO key on the remote controller, and you can see digital information of the program you are watching, such as channel number, system date, video resolution, etc.



Electronic Program Guide (EPG):

EPG is one of the most important features of digital TV. You can get system time, current program name/time and program description from this function.



Audio Language:

If the program you are watching contains other language for audio, you can select and change the audio language with ▲ or ▼ key and ENTER key from current program by pressing LANG key.



Video Freezing:

Press FREEZE key on remote controller, then you will see the Icon below on the screen and system will freeze video on TV monitor. This is a useful function when you need more time to review some important information, like phone number, address, for example.



7. OSD Settings:

This TV provides an "OSD" setting that enables you to customize the monitor settings. Note: Before adjusting settings, ensure all the video sources are in the correct mode.

Management Setting :

Press "MENU" button, OSD menu will display on screen, press "SET" button to select "Management setting", and press "ENTER" button to enter management setting, then press "SET" button to select course settings. (Please see chart below.)

PC Settings:

The sequence of OSD menu screens for PC settings is as follows:

- Picture Adjust**: Brightness (50), Contrast (50), Gamma (50), V-Position (50), Clock (50), Auto Image (NO).
- Color Temp.**: Cool, Normal, Warm.
- Color**: Red, Green, Blue.
- Audio Adjust**: Volume (50), Bass (50), Treble (50), Balance (50), Speaker (ON), Mute (OFF).
- PIP Source**: TV, AV2.
- PIP Mode**: ON, OFF.
- PIP Setting**: PIP Mode, PIP Size, PIP H Position, PIP V Position.

OSD Settings:

Management Setting :

Press "MENU" button, OSD menu will display on screen, press "SET" button to select "Management setting", and press "ENTER" button to enter management setting, then press "SET" button to select course settings. (Please see chart below.)

The sequence of OSD menu screens for Management Settings is as follows:

- PIP Setting**: PIP Mode, PIP Size, PIP H Position, PIP V Position.
- Menu Setting**: OSD V Position, OSD H Position, OSD Timeout, Language, OSD Exit.
- Menu Setting**: Language (English, Italian, German, Spanish, French, Chinese).

8. ANNEX A:

LCD Monitor Care & Cleaning Tips:

To avoid possible shock hazard, be sure the LCD TV is turn off and unplugged from the main electrical outlet before cleaning.

Do not use any form of solvents on the LCD monitor.

Cleaning the LCD Monitor:

1. Use a soft, clean & dry cloth to gently wipe off the dust on the LCD monitor.
2. Use a clean cloth dampened with water to wipe off the dirt.
3. Do not exert force when cleaning the LCD monitor.

Cleaning the Enclosure:

1. Use a soft, clean & dry cloth to gently wipe off the dust on the LCD monitor.
2. Use a clean cloth dampened with water to wipe off the dirt.
3. Do not exert force when cleaning the LCD monitor.

9. ANNEX B:

Troubleshooting:

If the unit fails to operate normally, try solving the problems using the guide below. If the problem persists, switch off the unit and ask the dealer or customer services officer for assistance. Do not attempt to repair the defective unit yourself. Do not endanger yourself as high voltage is involved.

1. No Picture:

- Check that the power cord is plugged into the main socket and the power supply is turned on.
- Check the contrast and brightness setting.
- Check the Antenna connection to see if it is properly connected to the LCD-TV Input Terminal.
- Be sure you have selected the correct source mode.

2. Snowy Picture:

- Check to see if the Antenna is correctly connected.
- Check to see if the picture setting is correctly set.

3. Picture Flickers:

- Check that the power coming from the main socket is sufficient.
- Check that unit is not placed near speakers or magnetic objects.
- Check to see that the unit setting is correctly set.

4. No Sound:

- Check that mute function is off.
- Increase the volume.

5. Remote Control not Working:

- Check batteries are installed correctly, replaced if necessary.
- Aim the remote controller towards the unit remote sensor.

6. Unit will not power on w/ front Power button:

- Check the power is connected.
- Power indication LED on unit is red in color.

10. SPECIFICATIONS:

Panel Type	Active Matrix LCD-TFT
Display Size	15.4" (Diagonal)
Aspect Ratio	16:9
Resolution	102,4000 Pixel (1280x800)
Display Colors	16.7 M
Luminance	500 cd/m ²
Contrast Ratio	500 :1
View Angle	H:<100 degrees, V: 50 degrees
TV-System	NTSC / ATSC
Speakers	2 x 3W
Audio DAC	96 kHz/24-Bit Audio-D/A-Converter
Inputs	1x (S-Video)/Component/CVBS Input <Mini-DIN>, 1x VGA Input, 1x AV-IN (RCA)
Outputs	1x AV-OUT (RCA)
IR-Transmitter	Channel 1: 2.3Mhz/2.8Mhz, Effective Angle:45° Effective Range:12 Feet Channel 2: 3.2Mhz/3.8Mhz, Effective Angle:45°
REMOTE RANGE	Effective Range:12 Feet
OSD-Language	English, French, Dutch, Spanish, Chinese (DTV English, French, Spanish)
Accessories	Monitor,Operating Manual, Remote Control, Component Video Conversion Cable, DC Power Harness, Composite Video Conversion Cable, IR Transmitter Audio Input Harness Antenna Coax Pigtail Cable

Noted: All specifications are subjected to change without prior notification

Free Manuals Download Website

<http://myh66.com>

<http://usermanuals.us>

<http://www.somanuals.com>

<http://www.4manuals.cc>

<http://www.manual-lib.com>

<http://www.404manual.com>

<http://www.luxmanual.com>

<http://aubethermostatmanual.com>

Golf course search by state

<http://golfingnear.com>

Email search by domain

<http://emailbydomain.com>

Auto manuals search

<http://auto.somanuals.com>

TV manuals search

<http://tv.somanuals.com>