

JENSEN®

DOCKING MUSIC SYSTEM FOR
iPod® and iPhone™



OWNER'S MANUAL JiMS-198i

(iPod/iPhone Not Included)

PLEASE READ THIS OPERATING MANUAL COMPLETELY BEFORE
OPERATING THIS UNIT AND RETAIN THIS BOOKLET FOR FUTURE REFERENCE.



DEAR JENSEN® CUSTOMER

Selecting fine audio equipment such as the unit you've just purchased is only the start of your musical enjoyment. Now it's time to consider how you can maximize the fun and excitement your equipment offers. This manufacturer and the Electronic Industries Association's Consumer Electronics Group want you to get the most out of your equipment by playing it at a safe level. One that lets the sound come through loud and clear without annoying blaring or distortion and, most importantly, without affecting your sensitive hearing. Sound can be deceiving. Over time your hearing "comfort level" adapts to higher volumes of sound. So what sounds "normal" can actually be loud and harmful to your hearing. Guard against this by setting your equipment at a safe level BEFORE your hearing adapts.

To establish a safe level:

- Start your volume control at a low setting.
- Slowly increase the sound until you can hear it comfortably and clearly, and without distortion.



Once you have established a comfortable sound level:

- Set the dial and leave it there.
- Taking a minute to do this now will help to prevent hearing damage or loss in the future. After all, we want you listening for a lifetime.

We Want You Listening For a Lifetime:

Used wisely, your new sound equipment will provide a lifetime of fun and enjoyment. Since hearing damage from loud noise is often undetectable until it is too late, this manufacturer and the Electronic Industries Association's Consumer Electronics Group recommend you avoid prolonged exposure to excessive noise.

Customer's Record:

The serial number of this product is found on its bottom cover. You should note the serial number of this unit in the space provided as a permanent record of your purchase to aid in identification in the event of theft or loss.



Model Number: JIMS-198i



Serial Number: _____



IMPORTANT SAFETY INSTRUCTIONS

When used in the directed manner, this unit has been designed and manufactured to ensure your personal safety. However, improper use can result in potential electrical shock or fire hazards. Please read all safety and operating instructions carefully before installation and use, and keep these instructions handy for future reference. Take special note of all warnings listed in these instructions and on the unit.

- 
- 
1. Read these instructions
 2. Keep these instructions
 3. Heed all warnings.
 4. Follow all instructions.
 5. Do not use this apparatus near water.
 6. Clean only with dry cloth.
 7. Ventilation – Slots and openings in the cabinet are provided for ventilation and to ensure reliable operation of the product and to protect it from overheating, and these openings must not be blocked or covered. The openings should never be blocked by placing the product on a bed, sofa, rug, or other similar surface. This product should not be placed in a built-in installation such as a bookcase or rack unless proper ventilation is provided or the manufacturer's instructions have been adhered to.
 8. Do not install near any heat sources such as radiators, heat registers, stoves, or other apparatus (including amplifiers) that produce heat.
 9. Grounding or Polarization – This product may be equipped with a polarized alternating-current line plug (a plug having one blade wider than the other). This plug will fit into the power outlet only one way. This is a safety feature. If you are unable to insert the plug fully into the outlet, try reversing the plug. If the plug should still fail to fit, contact your electrician to replace your obsolete outlet. Do not defeat the safety purpose of the polarized plug.
 10. Protect the power cord from being walked on or pinched particularly at plugs, convenience receptacles, and the point where they exit from the apparatus.
 11. Only use attachments / accessories specified by the manufacturer.
 12. Unplug this apparatus during lightning storms or when unused for long periods of time.
 13. Refer all servicing to qualified service personnel. Servicing is required when the apparatus has been damaged in any way, such as power-supply cord or plug is damaged, liquid has been spilled or objects have fallen into the apparatus, the apparatus has been exposed to rain or moisture, does not operate normally, or has been dropped.
 14. This appliance shall not be exposed to dripping or splashing water and that no object filled with liquids such as vases shall be placed on the apparatus.

- 
- 
15. Use only with the cart, stand, tripod, bracket, or table specified by the manufacturer, or sold with the apparatus. When a cart is used, use caution when moving the cart/apparatus combination to avoid injury from tip-over.



16. The MAINS plug is used as the disconnect device, the disconnect device shall remain readily operable.
17. Battery pack or battery installed shall not be exposed to excessive heat such as sunshine, fire or the like.
18. Name plate is located on bottom of product.

IMPORTANT NOTES



Avoid installing the unit in locations described below:

- Places exposed to direct sunlight or close to heat radiating appliances such as electric heaters.
 - Dusty places.
 - Places subject to constant vibration.
 - Humid or moist places.
- 





COMPLIANCE WITH FCC REGULATIONS

This device complies with Part 15 of the FCC Rules. Operation is subject to the following two conditions:

- (1) this device may not cause harmful interference, and
- (2) this device must accept any interference received, including interference that may cause undesired operation

This equipment has been tested and found to comply with the limits for a Radio Receiver, pursuant to Part 15 of the FCC Rules. These limits are designed to provide reasonable protection against harmful interference in a residential installation. This equipment generates, uses and can radiate radio frequency energy and, if not installed and used in accordance with the instructions, may cause harmful interference to radio communications. However, there is no guarantee that interference will not occur in a particular installation. If this equipment does cause harmful interference to radio or television reception, which can be determined by turning the equipment off and on, the user is encouraged to try to correct the interference by one or more of the following measures:

- 
- 
- Reorient or relocate the receiving antenna.
 - Increase the separation between the equipment and receiver.
 - Connect the equipment into an outlet on a circuit different from that to which the receiver is connected.
 - Consult the dealer or an experienced radio technician for help.

Caution

Changes or modifications to this unit not expressly approved by the party responsible for compliance could void the user's authority to operate the equipment.



POWER SOURCE

AC-DC ADAPTOR CONNECTION

The unit is powered by an external AC - DC Power Adaptor with an output of 10V DC - 1400mA (included).



- (1) Firmly and securely plug the adaptor's AC plug into a household AC wall adaptor.
- (2) Insert the adaptor's DC output plug into the DC -IN jack on the back of the unit.

Operating this unit from any other power source may cause damage to the unit and will void your warranty.

BATTERY BACK - UP SYSTEM

The radio is also pre-loaded with 2 x "AA" batteries for the battery back-up and for the Auto Time Set clock system.

The Battery Back-up System ensures the clock and alarm settings will be retained during a power interruption or power outage (in order to preserve the battery life the Display will not light). All clock settings will be kept in memory, however, the clock time may require adjustment for exact accuracy once the power returns. If the batteries are not installed, the Display will blink "12:00" when the power is restored. This will indicate that you have to reset the time and alarm settings.





BATTERY INSTALLATION

1. Open the battery compartment door on the bottom of the cabinet.
2. Insert 2 "AA" size batteries into the battery compartment according to the polarity diagram engraved inside the compartment.
3. Replace the battery compartment Door.
IMPORTANT: Be sure that the batteries are installed correctly. Wrong polarity may damage the unit.
4. Alkaline-type batteries are recommended. For optimum performance, these batteries should be replaced after every year or when batteries become exhausted.
5. Old or leaking battery can cause damage to the unit and will void the warranty.
6. Use only the size and type of batteries specified.
7. Do not mix old and new batteries.
8. Do not mix alkaline, standard (carbon-zinc) or rechargeable (nickel-cadmium) batteries.
9. Do not try to recharge batteries not intended to be recharged; they can overheat, rupture and leak. (Follow battery manufacturer's directions).
10. Do not dispose of batteries in fire, batteries may leak or explode.



POWER FAILURE INDICATOR

If there are no batteries installed in the unit or if the batteries installed are weak or dead, the time and alarm settings will be lost if the AC power is interrupted. When the AC power is restored the display will blink "12:00". This indicates that the time displayed is incorrect and needs to be reset.

IMPORTANT:

After you reset the time, be sure to reset your alarm settings as well.

NOTE:

This unit is not magnetically shielded and may cause color distortion on the screen of some TVs or video monitors. To avoid this, you may need to move the unit further away from the TV or monitor if unnatural color shifts or image distortion occurs

LOCATION OF CONTROLS AND INDICATORS

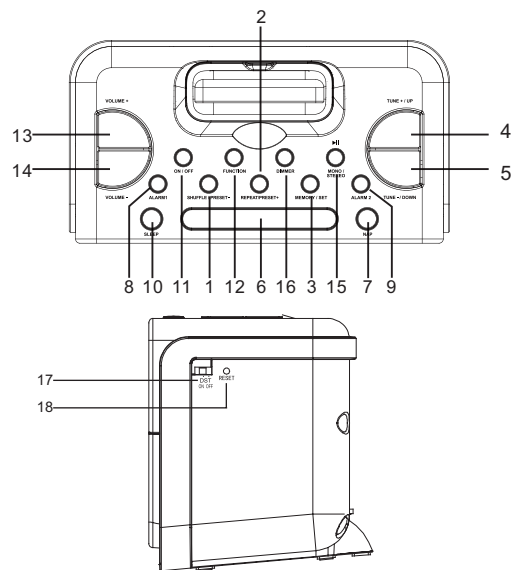

1. SHUFFLE / PRESET- BUTTON	10. SLEEP BUTTON
2. REPEAT / PRESET+ BUTTON	11. ON / OFF BUTTON
3. MEMORY / SET BUTTON	12. FUNCTION(FM / AM / iPod / AUX IN) BUTTON
4. TUNE+ / UP BUTTON	13. VOLUME + BUTTON
5. TUNE- / DOWN BUTTON	14. VOLUME - BUTTON
6. SNOOZE BUTTON	15. MONO / STEREO / PLAY / PAUSE BUTTON
7. NAP BUTTON	16. DIMMER BUTTON
8. ALARM 1 BUTTON	17. DAY LIGHT SAVING TIME SWITCH
9. ALARM 2 BUTTON	18. RESET BUTTON

LOCATION OF CONTROLS AND INDICATORS

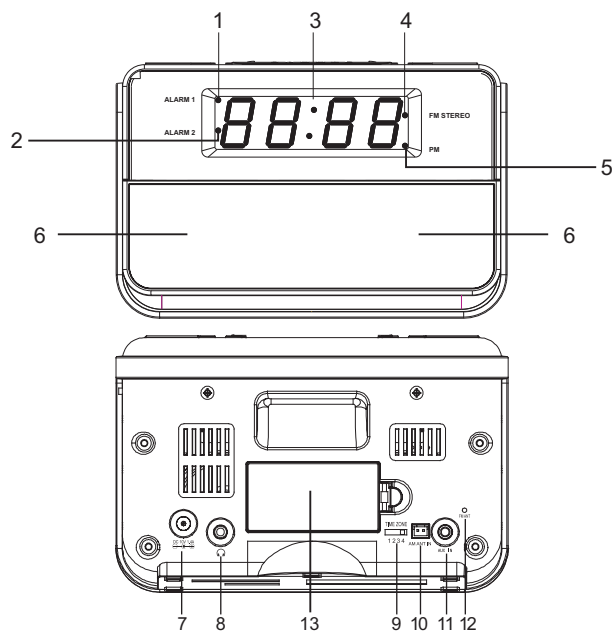

1. ALARM 1 INDICATOR	8. HEADPHONE OUTPUT JACK
2. ALARM 2 INDICATOR	9. TIME ZONE SWITCH
3. MULTI FUNCTION DISPLAY	10. AM LOOP ANTENNA JACK
4. FM STEREO INDICATOR	11. AUX IN JACK
5. FM CLOCK INDICATOR	12. FM ANTENNA
6. SPEAKER	13. BATTERY COMPARTMENT
7. DC INPUT JACK	

OPERATING INSTRUCTIONS

AUTO TIME SET

This unit features an Automatic Time Set system powered by 2 X "AA" batteries (3V DC) (Included), so you will not need to set the clock time when first plugged in. After the unit is plugged in, the LED display will show the time automatically. You will only need to set the correct time zone and daylight saving time for your area.

SETTING THE TIME ZONE

Change to your time zone area by sliding the TIME ZONE switch on the back of the unit to the appropriate time zone you live in. The default time zone is set to Eastern Standard Time (EST). Please refer to the time zone map below when setting the switch position on the back.

1. Eastern Standard Time (EST)
2. Central Standard Time (CST)
3. Mountain Standard Time (MST)
4. Pacific Standard Time (PST)

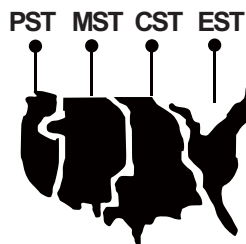

DAYLIGHT SAVING TIME

Slide the DST (Daylight Saving Time) switch on side of the unit to turn Daylight saving time on/off. The clock comes with DST in the ON position as the default. This setting is correct unless you live in Arizona or parts of Indiana where DST is not observed.

IMPORTANT: Do not change this setting unless you live in an area which does not observe the Daylight Saving time change.

NOTE: The batteries will become weak after time, so replace the batteries as needed. To avoid re-program the time and alarm settings, we recommend leaving the unit plugged in when changing the batteries.

SETTING THE CLOCK

In case the back-up batteries are accidentally removed. You will need to set the clock manually.

If the LED display is blinking

1. In standby mode, press the UP button to increase or press the DOWN button to decrease the minutes setting.
2. Press and hold the UP / DOWN button to fast forward/backward the clock setting.
3. Press the MEM/SET button to confirm the setting.

If the LED display is steady

1. In standby mode, press and hold MEMORY/SET button for 3 seconds, Time flashes on LED display when the time is AM, "PM" and time flashes on LED when time is PM.
2. Press the UP button to increase or press the DOWN button to decrease the minutes setting.
3. Press and hold the UP / DOWN button to fast forward/backward the clock setting.
4. Press the MEMORY/SET button again to confirm the setting.

NOTE:

There is a PM indicators located in the right-hand corner of the clock display. If it turns off, that means the time is AM. Be sure to observe the correct AM / PM time when setting the alarm to make sure the wake time is set correctly for AM or PM.

RADIO OPERATIONS

LISTENING TO RADIO

1. Press the power ON/OFF button to turn on the unit.
2. Press the FUNCTION button to select AM or FM radio mode. The AM or FM band radio frequency will appear on the display.
3. To manually tune the radio station, press the TUNE + or TUNE - button repeatedly.
4. To automatically scan to the next radio station with the strongest signal, press and hold the TUNE + or TUNE - button for 1-2 seconds until frequency readout on the display begins to scan and then release the button. The tuner will stop scanning when it receives the next strongest station signal.
5. Press the VOLUME+/VOLUME - button to adjust the volume to your desired listening level.
6. When you have finished listening, press the "ON/OFF" button to turn off the unit.



FM STEREO / MONO RECEPTION

1. This unit provides FM STEREO and FM MONO settings. In stereo mode, the unit will automatically switch to stereo when a FM stereo broadcast is received. The FM ST indicator turns on.
2. To receive a weak (noisy) FM station, press the MONO/STEREO button once to switch the FM mode to "MONO". The FM ST indicator turns off, the reception may be improved, but the sound is now monaural (MONO).

Note:

1. When listening to an FM program, fully extend the Wire Antenna to insure maximum tuner sensitivity.
2. The AM receiver uses an external AM loop antenna. If the AM reception is weak, slightly rotating or re-positioning the loop antenna will usually improve the AM reception.
3. Automatic tuning depends on the signal strength of the broadcasting station, so weak stations may be skipped. You can manually tune to find the weak stations if a station gets skipped. With strong signals, the tuner may stop before it reaches the actual broadcast frequency, so you may need to manually tune for the best reception.



PRESET MEMORY CHANNELS

1. Turn on the radio and press TUNE+ / TUNE- buttons to select the desired channel,
2. Press the MEMORY/SET button once, LED will flash, press PRESET+ / PRESET- button to select location P01 ~ P10 for setting the channel, press MEMORY/SET button to confirm.
3. Repeat steps 1 ~ 2 to set more channels. Both AM and FM stations can be pre-set (up to 10 channels).

RECALL PRESET MEMORY CHANNELS

In AM / FM radio mode, recall the pre-set channels by pressing the PRESET+ / PRESET - button.

LISTENING TO iPod AND iPhone

PLAYBACK

1. To play your iPod, insert the adaptor included with your iPod into the docking bay area.
To play your iPhone, insert the included adaptor into the docking bay area.
Your iPod / iPhone can now be docked by placing the connector on the bottom of the iPod / iPhone onto the connector in the docking bay.

Note: 1. Please be careful when docking the iPod / iPhone. Excessive force or pressure can damaging the 30-pin connector on iPod or on the docking system.
2. Use the right iPhone adaptor (2G or 3G) before plugging in your iPhone.

2. Press the power ON/OFF Button to turn on the unit.
3. Press the FUNCTION button to select " iPod " mode, "iPod" shows on LED display and the system will start playback automatically.
4. Press the PLAY/PAUSE button to pause or resume iPod playback.
5. Press the UP or DOWN button to skip to next or previous track.
6. Adjust volume control to the desire volume level.

Note: The volume level cannot be adjusted using the volume control on your iPod / iPhone after being docked.

7. To remove the iPod / iPhone from the unit, press and hold the PLAY/PAUSE ►|| button for five seconds to switch off the device and then gently remove of form the docking connector.

Note: 1. When playing your iPhone, playback will be suspended if there is an incoming call, the iPhone will ring. Touch the Answer icon on your iPhone once to pick up the call, touch the Speaker button once to answer the call in handsfree mode, press the End Call Icon when you have finished your call. Music will resume.
2. To enhance sound quality in handsfree mode, you should always use the dock adaptor when docking the iPhone.

CHARGING

When an iPod or iPhone is docked in the docking bay it will be charged in all function modes.

OTHER iPod / iPhone CONTROL FUNCTION KEYS

1. SHUFFLE : Press the "SHUFFLE/PRESET-" button to play music from your iPod or iPhone randomly.
2. REPEAT: Press the "REPEAT/PRESET+" button to repeat a single track or repeat all tracks from your iPod or iPhone.

Note: 1. To prevent damaging the dock connector, never twist the iPod / iPhone when inserting or removing it. Make sure the connector in the dock is lined up with the connector on the iPod before attaching.

2. Be careful not to knock over the iPod when it is inserted in the dock.

USING HEADPHONES (NOT INCLUDED)

Insert the plug of your headphones (not included) into the Headphone jack, on the back of the unit and you can now listen in private. When using headphones, the speakers will be disconnected automatically.

NOTE: READ THIS IMPORTANT INFORMATION BEFORE USING YOUR HEADPHONES

1. Avoid extended play at very high volume as it may impair your hearing.
2. If you experience ringing in your ears, reduce the volume or shut off your unit.
3. Keep the volume at a reasonable level even if your headset is an open-air type designed to allow you to hear outside sounds. Please note that excessively high volume may still block outside sounds.

ALARM OPERATIONS

SETTING THE WAKE UP TIME

This unit has Dual Alarm function. Each ALARM can be set to wake to RADIO, iPod / iPhone or ALARM. To set alarm time:

1. In standby mode, press and hold ALARM1 or ALARM2 button for 3 seconds to enter the ALARM setting mode, LED shows the default alarm time 12:00 AM and the ALARM1 or ALARM2 indicator flashing on the display.
2. Press UP / DOWN button to adjust minutes of you desired ALARM time. Press and hold the button for fast forward / backward setting the alarm time.
3. Press ALARM1 or ALARM2 button again to confirm the ALARM time setting.
4. Press ALARM1 or ALARM2 repeatedly to select wake to ALARM (**buZ**), RADIO (**rAd**), iPod / iPhone (**IPod**) or turn off the alarm.

CHECKING THE WAKE UP TIMES

To check the wake up time, simply press and hold the ALARM 1 or ALARM 2 button for 3 seconds. The display will change from current time to wake up time. Release the ALARM button, it will return to current time after 5 seconds.

WAKE TO RADIO

1. To select wake to radio mode, press the ALARM button you want to set repeatedly until the display shows "**rAd**".
2. Release the ALARM button and waiting about 3 seconds to confirm.

- NOTE:** The last radio station you listen to will be the same station you will wake to.
3. The radio will automatically turn on and the ALARM indicator will flash when the alarm time is reached. The volume starts softly and becomes gradually louder.
 4. The radio alarm will keep sounding for 60 minutes and then automatically shut off and resets for wake up at the same time the following day.
 5. To stop the alarm immediately, press the ON/OFF button once. The radio will stop but the alarm remains set and will turn on again at the same time the following day.
 6. To turn off the alarm completely, press the ALARM button repeatedly until the ALARM indicator turns off.

WAKE TO iPod or iPhone

1. To select wake to iPod or iPhone mode, in standby mode, dock your iPod / iPhone into the docking of the unit properly.
2. Press the ALARM button you want to set repeatedly until display shows "iPod".
3. Release ALARM button and waiting about 3 seconds to confirm.
4. The iPod / iPhone will automatically turn on and ALARM indicator flashing when alarm time is reached. It starts softly and becomes gradually louder.
5. The iPod / iPhone alarm will keep playing for 60 minutes and then automatically shut off until same time on the following day.
6. To stop the alarm immediately, press the ON/OFF button once. The radio will stop but the alarm remains set and will turn the unit on again at the same time on the following day.
7. To turn off the alarm completely, press the ALARM button repeatedly until ALARM indicator turns off.

NOTED: When "wake to iPod or iPhone" is selected but you iPod or iPhone has not been docked, the alarm source will be redirected to the Buzzer automatically when the alarm time is reached.

WAKE TO BUZZER

1. To select wake to ALARM mode, press the ALARM button repeatedly until the display shows "buZ".
2. Release the ALARM button and wait about 3 seconds to confirm the setting.
3. The buzzer alarm will automatically turn on and the ALARM indicator will flash when alarm time is reached. It starts softly and becomes gradually louder.
4. The buzzer alarm will keep sounding for 60 minutes and then automatically shut off and resets for wake up at the same time the following day.
5. To stop the alarm immediately, press the ON/OFF button once. The buzzer alarm will stop but the alarm remains set and will turn on again at the same time the following day.
6. To turn off the buzzer alarm completely, press the ALARM button repeatedly until ALARM indicator turns off.

NOTE: If the second alarm time is set to go off before the first alarm period (60 minutes) expires, first alarm will be turned off automatically when second alarm time is reached.



SNOOZE OPERATION

You may activate the SNOOZE function manually after the alarm sounds by pressing the SNOOZE button. The snooze time can be adjusted from 1 ~ 30 minutes. The default snooze time setting is 9 minutes.

SNOOZE TIME SETTING:

1. In standby mode, press and hold the SNOOZE for 3 seconds, the display shows current snooze time and flashes.
2. Press the UP / DOWN button to increase / decrease the snooze time.
3. Snooze function only effective in 59 minutes., the alarm will not sound after that period.

SNOOZE FUNCTION

1. When the ALARM sounds, press the SNOOZE button to temporarily pause the ALARM. The ALARM will come again after the pre-set SNOOZE time is reached.
2. Pressing the SNOOZE button will display the remaining SNOOZE time left.
3. Manual SNOOZE operation can be repeated again within alarm duration (59 mins). Actual buzzer duration will be 59 minutes minus SNOOZE time. E.g. after buzzing for 30 mins, 9 mins SNOOZE time selected, remaining buzzing duration will be 20 mins.



NAP OPERATION

You can set the alarm to go off for short catnaps up to two hours without disturbing the regular alarm settings. The NAP function will wake you up after a short preset period of time. You can set the NAP alarm time from 10 to 120 minutes.

1. Press the "NAP" button to enter NAP mode, the LED flashes showing "20", on the display. Press the NAP button to show 20-30-60-120-OFF (showing normal clock).
2. Press the UP/DOWN buttons to set exact NAP alarm time you desired between 10 ~ 120 minutes.
3. Wait for 3 seconds to confirm, NAP time will stop flashing and return to normal clock display.
4. When the countdown time has been reached, there will be a "beeping" alarm sound.
5. Press the snooze button to pause the NAP alarm. Alarm will sound again after snooze expired.
6. NAP will stop automatically after sounding for 60 minutes if the SNOOZE button is not pressed. Press the power ON/OFF button once if you want to cancel the NAP alarm immediately.

SLEEP TIEMR OPERATION

The Sleep Timer allows you to set the unit automatically power off after a selected sleep time duration is set. Sleep time function can be set from 1 minute to 120 minutes.

1. In unit power ON mode, press the SLEEP button to enter SLEEP setting. LED flashing and showing "90". Press the SLEEP button repeatedly, it shows 90-60-30-15-OFF (display showing normal clock) for selection.
2. Press the UP / DOWN buttons to select exact minutes you desired.
3. Wait for 3 seconds to confirm, sleep time will stop flashing and return to normal clock display. If sleep set successful, unit will automatically turns to standby mode when pre-set sleep timer expired.
4. Press the sleep button once to check remained sleep time if necessary during sleep timer count down.
5. To switch off the unit before the selected sleep time, press the power ON/OFF button once.

Note :

If you are falling asleep to music from an external device connected to the AUX input, the sleep timer will shut off the power to this system but it will not turn off the external device.

BACKLIGHT BRIGHTNESS OPERATION

Press the DIMMER button to adjust the LED display Hi / Lo brightness. The brightness default setting is Hi.

AUXILIARY INPUT

This unit provides an auxiliary audio signal input jack for connecting external audio devices like MP3 players, CD players and older, non-dockable iPods and listen to your external source through the speakers of this system.

1. Use an audio cable (not included) with one 3.5 mm stereo plug on each end of the cable.
2. Plug one end into the Aux-in jack on the main unit and the other end of the cable into the Line-out Jack or Headphone Jack of your external audio device.
3. Turn on the external audio device.
4. To select auxiliary audio input, press the FUNCTION button to select Aux In mode. LED display will show "AuH"
5. The volume level can now be controlled through the main unit. Operate all other functions on the auxiliary device as usual.

Note:

If you connected the Line Out Jack of your external device then you only need to adjust the volume control of this system. If you connected the Headphone Jack of your external device then you may need to adjust both the volume control of your external device and the volume control of this system to find the most desirable volume setting.

CARE AND MAINTAINANCE

- Do not subject the unit to excessive force, shock, dust or extreme temperature.
- Do not tamper the internal components of the unit.
- Clean your unit with a damp (never wet) cloth. Solvent or detergent should never be used.
- Avoid leaving your unit in direct sunlight or in hot, humid or dusty places.
- Keep your unit away from heating appliances and sources of electrical noise such as fluorescent lamps or motors.

Resetting the Unit

If the unit is subject to a power surge or electric shock, it is possible that the internal micro-controller may lock up and the unit will not respond to any commands from the top panel controls or remote control.

1. In this event, unplug and then reconnect the AC power plug into the wall outlet.
2. Use a straightened paper clip, toothpick or similar objects to press the RESET button located on the side of the main unit (see the below figure). The reset operation clears the system memory and all of your previous settings will be erased.

CAUTION: DO NOT USE SHARP, POINTED OBJECT TO PRESS THE RESET BUTTON. IT MAY DAMAGE THE RESET SWITCH INSIDE THE UNIT.

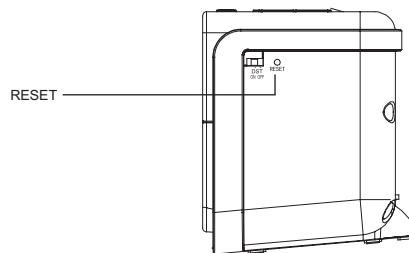

TROUBLESHOOTING GUIDE

Symptom	Possible Problem	Solution
The unit does not respond (no power)	AC Adaptor is not plugged into a wall outlet or the connector is not plugged into the power supply jack on the back of the unit.	Plug the AC adaptor into a wall outlet and plug the connector into the supply jack on the unit.
	Wall outlet is not functioning.	Plug another device into the same outlet to confirm the outlet is working.
	iPod / iPhone does not install properly.	Remove your iPod / iPhone from the dock and check for obstruction on the connectors in the dock and on your iPod/iPhone. Then reseat it in the dock.
iPod / iPhone does not respond to the speaker system	iPod / iPhone is not installed properly.	Remove your iPod / iPhone from the dock and check for obstruction on the connectors in the dock and on your iPod / iPhone. Then reseat it on the dock.
	Your iPod / iPhone is locked up.	Please make sure that your iPod/iPhone is working properly before docking into the unit. Please refer to your iPod / iPhone manual for details.
iPod / iPhone does not charge up	iPod / iPhone is not installed properly.	Remove your iPod / iPhone from the dock and check for obstruction on the connectors in the dock and on your iPod / iPhone. Then reseat it in the dock.
	iPod / iPhone is locked up/ frozen. iPod / iPhone battery has problem.	Please make sure your iPod / iPhone is working properly before docking into the unit. Please refer to your iPod® manual for details.
AM band is too noisy	The reception at the set location is poor.	Slightly rotate the AM loop antenna for the best reception.
Sound is distorted	Volume level is set too high.	Decrease the volume.
	Sound source is distorted.	If the iPod original sound source is of poor quality, distortion and noise are easily noticed with high-power speakers. Try a different audio source such as a music CD. If you are using an external sound source like older generation of iPod / iPhone, try reducing the output volume on the device itself. Also try turning bass boost OFF or change the EQ setting.
Unit gets warm after extended play at high volume	This is normal.	Turn the unit off for a period of time or lower volume.

Free Manuals Download Website

<http://myh66.com>

<http://usermanuals.us>

<http://www.somanuals.com>

<http://www.4manuals.cc>

<http://www.manual-lib.com>

<http://www.404manual.com>

<http://www.luxmanual.com>

<http://aubethermostatmanual.com>

Golf course search by state

<http://golfingnear.com>

Email search by domain

<http://emailbydomain.com>

Auto manuals search

<http://auto.somanuals.com>

TV manuals search

<http://tv.somanuals.com>