

**JENSEN**<sup>®</sup>

**banshee**<sup>™</sup>

**DOCKING SPEAKER STATION FOR iPod<sup>®</sup>**



**OWNER'S MANUAL  
JiSS-330**

**(iPod<sup>®</sup> Not Included)**

**PLEASE READ THIS OPERATING MANUAL COMPLETELY BEFORE OPERATING  
THIS UNIT AND RETAIN THIS BOOKLET FOR FUTURE REFERENCE**

JISS-330 US IB V.02

成書尺寸: 148.5 X 210mm

用8張210 x 297mm 合共32頁

80gms 書紙, bk+bk

2007.05.30

## TABLE OF CONTENTS

DEAR JENSEN® CUSTOMER .....	2
IMPORTANT SAFETY INSTRUCTIONS .....	3
COMPLIANCE WITH FCC REGULATIONS .....	4
PRODUCT FEATURES .....	4
INSTALLATION .....	5
LOCATION OF CONTROLS .....	5-6
iPod ADAPTORS .....	7
SYSTEM PLACEMENT .....	8
iPod DOCKING .....	9
DOCKING 1st AND 2nd GENERATION iPod nanos .....	10
VIDEO OUT FROM THE iPod .....	10
AUXILIARY INPUT .....	11
SUBWOOFER OUTPUT .....	12
CARE AND MAINTENANCE .....	12
TROUBLESHOOTING GUIDE .....	13
SPECIFICATIONS .....	14
SERVICE .....	14

iPod , iPod mini, iPod nano and iPod shuffle are trademarks of Apple Inc.,

## DEAR JENSEN® CUSTOMER

Selecting fine audio equipment such as the unit you've just purchased is only the start of your musical enjoyment. Now it's time to consider how you can maximize the fun and excitement your equipment offers. This manufacturer and the Electronic Industries Association's Consumer Electronics Group want you to get the most out of your equipment by playing it at a safe level. One that lets the sound come through loud and clear without annoying blaring or distortion and, most importantly, without affecting your sensitive hearing. Sound can be deceiving. Over time your hearing "comfort level" adapts to higher volumes of sound. So what sounds "normal" can actually be loud and harmful to your hearing. Guard against this by setting your equipment at a safe level BEFORE your hearing adapts.

### To establish a safe level:

- Start your volume control at a low setting.
- Slowly increase the sound until you can hear it comfortably and clearly, and without distortion.

### Once you have established a comfortable sound level:

- Set the dial and leave it there.

Taking a minute to do this now will help to prevent hearing damage or loss in the future. After all, we want you listening for a lifetime.

### We Want You Listening For a Lifetime

Used wisely, your new sound equipment will provide a lifetime of fun and enjoyment. Since hearing damage from loud noise is often undetectable until it is too late, this manufacturer and the Electronic Industries Association's Consumer Electronics Group recommend you avoid prolonged exposure to excessive noise.

### Customer's Record:

The serial number of this product is found on its bottom cover. You should note the serial number of this unit in the space provided as a permanent record of your purchase to aid in identification in the event of theft or loss.

Model Number: JiSS-330

Serial Number: \_\_\_\_\_

## IMPORTANT SAFETY INSTRUCTIONS

When used in the directed manner, this unit has been designed and manufactured to ensure your personal safety. However, improper use can result in potential electrical shock or fire hazards. Please read all safety and operating instructions carefully before installation and use, and keep these instructions handy for future reference. Take special note of all warnings listed in these instructions and on the unit.

### 1. Water and Moisture

The unit should not be used near water. For example: near a bathtub, washbowl, kitchen sink, laundry tub, swimming pool or in a set basement.

### 2. Ventilation

The unit should be situated so that its location or position does not interfere with its proper ventilation. For example, it should not be situated on a bed, sofa, rug or similar surface that may block the ventilation openings. Also, it should not be placed in a built-in installation, such as a bookcase or cabinet, which may impede the flow of air through the ventilation openings.

Minimum distances (10cm) around the apparatus for sufficient ventilation; the ventilation should not be impeded by covering the ventilation openings with items such as newspaper, table-cloths, curtains etc.

### 3. Heat and Flame

The unit should be situated away from heat sources such as radiators, heat registers, stoves or other appliances (including amplifiers) that produce heat.

No naked flame sources such as lighted candles should be placed on the apparatus.

### 4. Power Source

The unit should be connected to a power supply only of the type described in the operating instructions or as marked on the appliance.

### 5. Cleaning

The unit should be cleaned only as recommended. See the section "Care and Maintenance" of this manual for cleaning instructions.

### 6. Object and Liquid Entry

Care should be taken so that objects do not fall and liquids are not spilled into any openings or vents located on the product.

### 7. Attachments

Do not use attachments not recommended by the product manufacturer.

### 8. Lightning and Power Surge Protection

Unplug the unit from the wall outlet and disconnect the periods of time. This will prevent damage to the product due to lightning and power-line surges.

### 9. Overloading

Do not overload wall outlets, extension cords, or integral convenience receptacles as this can result in a risk of fire or electric shock.

### 10. Damage Requiring Service

This unit should be serviced by qualified service personnel when:

- A. The power supply cord or plug has been damaged.
- B. Objects have fallen into or liquid has been spilled into the enclosure.
- C. The unit has been exposed to rain.
- D. The unit has been dropped or the enclosure damaged.
- E. The unit exhibits a marked change in performance or does not operate normally.

### 11. Periods of Nonuse

If the unit is to be left unused for an extended period of time, such as a month or longer, the AC adaptor should be unplugged from the unit to prevent damage or corrosion.

### 12. Environment

Attention should be drawn to the environmental aspects of battery disposal; the use of apparatus in moderate climates.

### 13. Servicing

The user should not attempt to service the unit beyond those methods described in the user's operating instructions. Service methods not covered in the operating instructions should be referred to qualified service personnel.

## COMPLIANCE WITH FCC REGULATIONS

This device complies with Part 15 of the FCC Rules. Operation is subject to the following two conditions:  
 (1) This device may not cause harmful interference, and (2) this device must accept any interference received, including interference that may cause undesired operation.  
 In accordance with FCC requirements, changes or modifications to this unit not expressly approved by the party responsible for compliance could void the user's authority to operate the equipment.

### NOTE:

This equipment has been tested and found to comply with the limits for a Class B Digital Device, pursuant to Part 15 of the FCC Rules. These limits are designed to provide reasonable protection against harmful interference in a residential installation. This equipment generates, uses and can radiate radio frequency energy and, if not installed and used in accordance with the instructions, may cause harmful interference to radio communications. However, there is no guarantee that interference will not occur in a particular installation. If this equipment does cause harmful interference to radio or television reception, which can be determined by turning the equipment off and on, the user is encouraged to try to correct the interference by one or more of the following measures:

- Reorient or relocate the receiving antenna.
- Increase the separation between the equipment and receiver.
- Connect the equipment into an outlet on a circuit different from that to which the receiver is connected.
- Consult the dealer or an experienced radio/TV technician for assistance.

## PRODUCT FEATURES

JiSS-330 is a Docking Speaker Station for iPod which incorporates the following features :

- Player / Re-charger for iPod , iPod mini and iPod nano
- Interchangeable iPod Adaptors
- Video Line-out provides video signal output when iPod with video is docked
- Audio line-in for connecting other digital audio player
- Built-in 3 High Fidelity Speakers with surround sound effect.
- Subwoofer output signal is available for the connection of an external active(self-powered) subwoofer.

## INSTALLATION

### Remote Control battery

The battery compartment is located on the bottom of the Remote Control.

- (1) Remove the battery compartment door.
- (2) Follow the polarity diagram shown inside the compartment and install 2x "AAA" batteries (included).
- (3) Replace the battery compartment door.

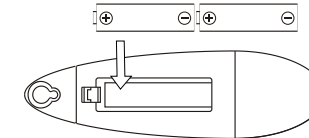

### WARNING:

- Be sure that the batteries are installed correctly. Wrong polarity may damage the Remote Control.
- Do not mix old and new batteries.
- Do not mix alkaline, standard (carbon-zinc) or rechargeable (nickel-cadmium) batteries.
- Only batteries of the same or equivalent type as recommend are to be used.
- If the Remote Control is not to be used for an extended period of time, remove the battery.
- Do not dispose of batteries in fire, batteries may explode or leak.

### AC Adaptor Connection

The unit is powered by an external AC Adaptor with an output of 15V DC , 1100 mA (included).

- (1) Firmly and securely plug the AC Adaptor into AC main outlet.
- (2) Insert the AC Adaptor output plug to the power input jack on the back of the unit.

## LOCATION OF CONTROLS

### Main Unit

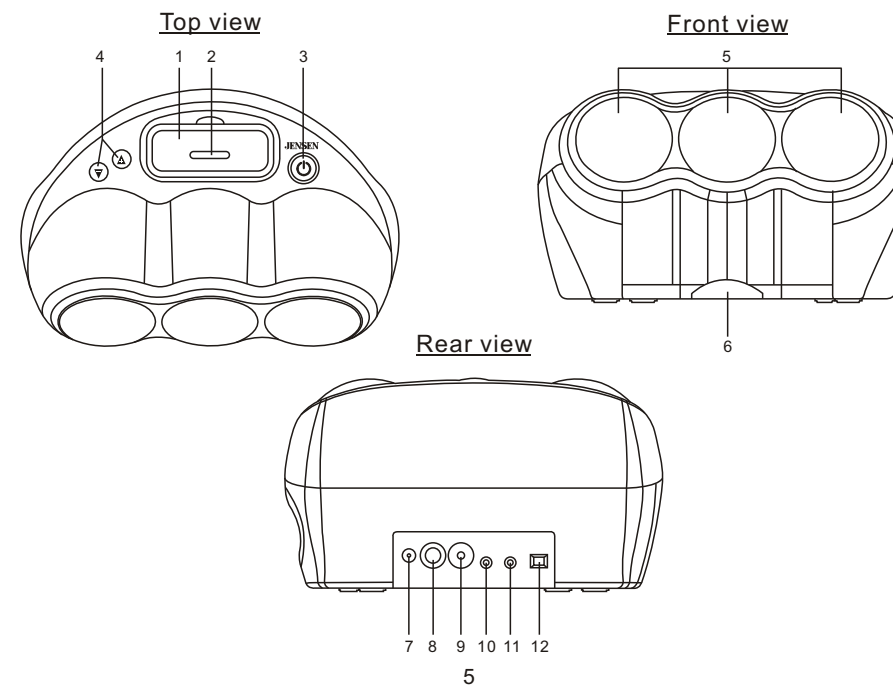



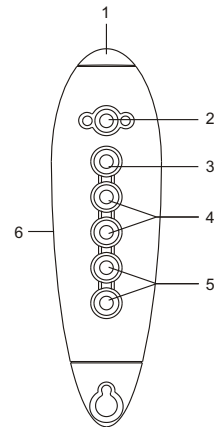

## LOCATION OF CONTROLS

1. iPod® docking bay
2. iPod® docking connector
3. ON/STANDBY  button ----- To turn the unit on or off.
4. VOLUME +/- button ----- Adjust volume level up or down.
5. Three Speakers
6. Remote Infrared Sensor
7. DC15V IN jack ----- For the connection of external DC power supply.
8. S-VIDEO Jack ----- S-Video signal output
9. RCA VIDEO Jack ----- Composite video signal output
10. Subwoofer Out ----- For the connection of external active(self-powered) Subwoofer.
11. AUX Input Jack ----- For the connection of external audio input source.
12. Audio Input Selector switch ----- Select iPod or Auxiliary input.

### Remote Control



1. Infra-red Transmitter
2. ON/STANDBY  button ----- To turn the unit on or off
3. iPod PLAY/PAUSE  button
4.  /  buttons ----- Skip iPod tracks Forward/Backward or perform high-speed search.
5. VOLUME +/- button ----- Adjust volume level up or down.
6. Battery Compartment ----- located on bottom of the Remote Control.

## iPod ADAPTORS

Please see below for the iPod Adaptor included in the package:

iPod Models	iPod Adaptor
Docking Cover	
iPod nano	
iPod mini	
3Gen iPod 10/15GB 4Gen iPod 20GB iPod Photo 20/30GB	
3Gen iPod 30/40GB 4Gen iPod 40GB	
iPod Photo 40/60GB	

NOTE: No adaptors are provided for iPod with video 30GB, 60GB and 80GB. Please use the adaptors included with these iPods at time of purchase. They will fit properly into the docking bay of this system.

## SYSTEM PLACEMENT

We recommend that you place the JiSS-330 properly on your desk, counter or table. The unit produces exceptional sound from any listening position in the room. However, the best quality sound and surround sound effects will be heard with the unit placed directly in front of you and facing you.

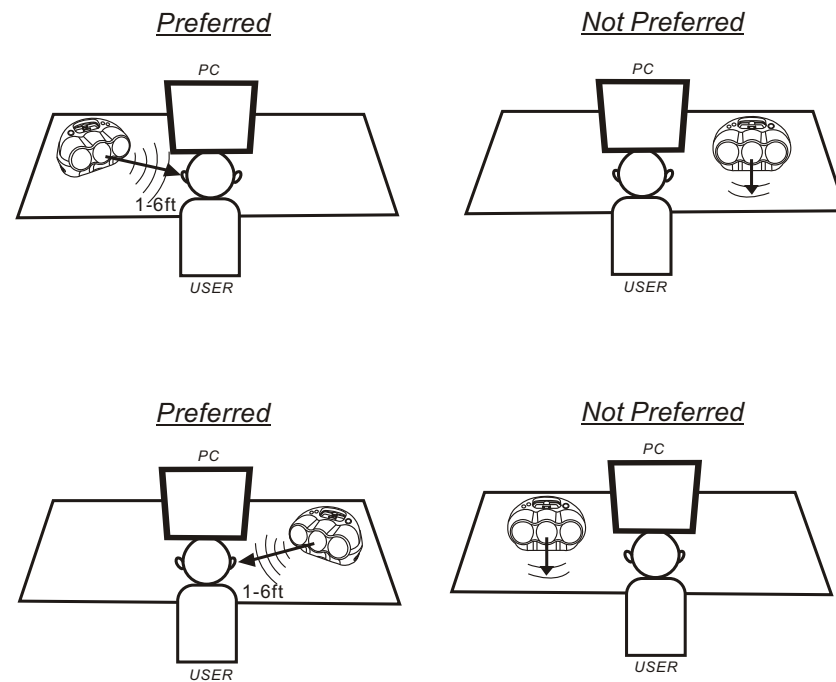

Refer to your iPod operation manual to adjust the "EQ" setting on your iPod. This will enhance the sound and also help adjust the sound to the room you are using it in.

## iPod DOCKING

This model includes adaptors for adopting different iPod models. If the docking bay will not be used for an extended period of time, it is recommended to use the "Dock Cover" insert to help protect the docking connector.

1. Select a suitable adaptor for your iPod and insert it into the docking bay.
2. Your iPod can now be docked by placing the connector on the bottom of the iPod directly over the dock connector located in the docking bay. Seat the iPod on the dock connector to assure a proper connection. For docking an iPod nano, slide the dock connector to the left and also see note on "DOCKING 1st AND 2nd GENERATION iPod nanos" section of this instruction manual. For other iPod models, slide the dock connector to the right (center position) and insert the iPod adaptor for the type of iPod you are using.
3. Insert your iPod with the connector facing down and positioned directly over the dock connector located in the docking bay. Seat the iPod on the dock connector to assure a proper connection.

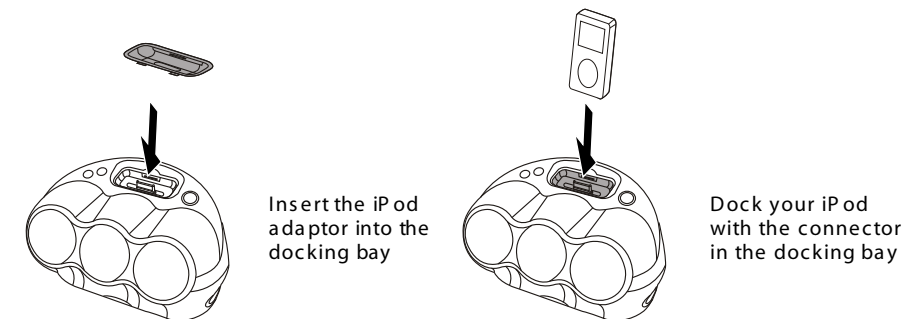
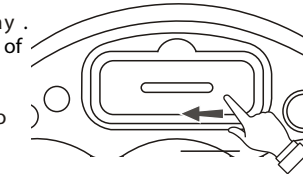

Note: When docking your iPod, please be careful to avoid damaging the 30-pin connectors located on the iPod and in the docking bay.

4. Slide the Audio Input Selector switch on the back of the unit to iPod position.
5. Press the ON/STANDBY button to turn On the main unit.
6. Press the PLAY / PAUSE button from the Remote Control to pause or resume iPod playback.
7. Adjust the sound level by pressing the VOLUME +/- buttons.
  - Note: The Volume level cannot be adjusted using the volume control on your iPod when docked.
8. The iPod charges even during playback.
9. To remove the iPod from the Docking bay, press and hold the PLAY / PAUSE button for three seconds to switch off the iPod. You can now gently remove it from the docking bay.

iPod playback control from remote control:

- Press the PLAY/PAUSE button to pause or resume the iPod playback;
- Press the iPod Skip/Search Forward or Backward button to skip to the next or previous song;
- Press and hold the iPod Skip/Search Forward or Backward button for fast-forwarding or fast-rewinding during playback.

## DOCKING 1<sup>st</sup> AND 2<sup>nd</sup> GENERATION iPod nanos

First install the iPod nano bracket into the JiSS-330 Bay.

**1<sup>st</sup> Generation iPod nano:** Align your 1<sup>st</sup> generation iPod nano to the LEFT side of the opening in the nano bracket (Figure 1). Make sure the connector on the bottom of the nano is positioned over the connector in the JiSS-330 dock prior to seating the nano. Carefully slide the nano down onto the connector in order to insure a secure connection.

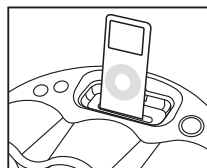

Figure 1

**2<sup>nd</sup> Generation iPod nano:** Align your 2<sup>nd</sup> generation iPod nano to the RIGHT side of the opening in the nano bracket (Figure 2). Make sure the connector on the bottom of the nano is positioned over the connector in the JiSS-330 dock prior to seating the nano. Carefully slide the nano down onto the connector in order to insure a secure connection.

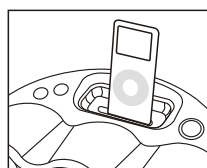

Figure 2

**Note:** Be careful not to damage the connector when docking the nano. Never use force when docking the nano onto the connector.

## VIDEO OUT FROM THE iPod

You are able to view videos and photos stored in your 5th Generation iPod on a larger television screen or monitor using the built-in Video Output jacks on the back of the unit.

Two video output jacks are available on the back of the unit.

- (1) S-VIDEO — S-Video signal.
- (2) RCA VIDEO — composite video signal (most common on standard televisions with video in).

### **Video Out (For 5th Generation iPods with video ONLY)**

1. You can connect this unit to a television or other video display that has S-video or composite video inputs.
2. Securely dock the iPod with video in the docking bay.
3. Connect the S-video cable (included) into the rear S-video jack or yellow RCA cable (included) to rear RCA video jack on the unit.
4. Connect the other end of the S-video or yellow RCA cable to VIDEO IN on your television or video display.
5. Slide the Audio Input Selector switch on the back of the unit to iPod position.
6. Select a movie from your iPod menu.
7. iPod: On the main menu choose video then select video setting.
8. iPod: Make sure the TV Out section is set to "ON".
9. iPod: Switch back to the movie library and play the movie of your choice.

### **For Photo view (For iPod with color display ONLY - excludes nano)**

1. Slide the Audio Input Selection switch on the back of the unit to iPod position.
2. Securely dock the iPod with color display.
3. iPod: At TV Out section, make sure it is set to "ON".
4. iPod: Go to Photo Library and then press play. The slideshow will play on your device.

**Note:** 1. The RCA Video input connector on a television is usually color coded yellow to match the color on the AV cable.  
2. When playing slideshows or videos, the audio will only playback through the speakers on this unit.

## AUXILIARY INPUT

This model provides an auxiliary audio signal input for connecting an external audio device. You may connect an audio cable with 3.5 mm stereo plug (included) to the **AUX IN** Jack located on the back of the unit. Connect the other end of the cable to the Line Out Jack or Headphone Jack of your MP3 player, CD player and other non-dockable iPods. You can now listen to your external source through the speakers of this system.

1. Connect an audio cable with 3.5 mm stereo plug to the **AUX IN** Jack located on the back of the unit.

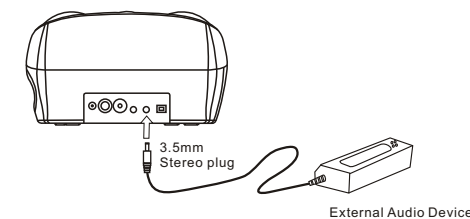

2. Slide the **Audio Input Selector** switch to **AUX IN** position.
3. Connect the other end of the cable to the Line Out Jack or Headphone Jack of your external audio device.
4. Turn on the external audio device.
5. The volume level can now be controlled using the main unit.  
Operate all other functions on the attached auxiliary device as your normally would.

### **Note:**

- (1) If your connected using the Line Out Jack of your external device, then you can only adjust the volume using the JiSS-330 control. If your connected using the Headphone Jack of your external device, then you may need to adjust both the volume controls (JiSS-330 and external device) to get the best volume level.
- (2) Press the **ON/STANDBY** button to turn off the unit when you finish listening.  
Don't forget to switch off the power of your external device as well.

## SUBWOOFER OUTPUT

This unit provides a separate subwoofer output jack for connecting an external active (self-powered) subwoofer speaker (not included). This will enhance and expand your sound by adding an extra deep rich bass channel to the unit. The Subwoofer Output Jack is located on the back of the unit.

## CARE AND MAINTENANCE

- Do not subject the unit to excessive force, shock, dust or extreme temperature.
- Do not tamper the internal components of the unit.
- Clean your unit with a damp (never wet) cloth. Solvent or detergent should never be used.
- Avoid leaving your unit in direct sunlight or in hot, humid or dusty places.
- Keep your unit away from heating appliances and sources of electrical noise such as fluorescent lamps or motors.

## TROUBLESHOOTING GUIDE

Symptom	Possible Problem	Solution
The unit does not respond (no power)	AC Adaptor is not plugged into a wall outlet or the output connector is not plugged into the <b>DC15V IN</b> jack on the back of the unit.	Plug the AC adaptor into a wall outlet and plug the output connector into the <b>DC15V IN</b> jack on the unit.
	Wall outlet is not functioning.	Plug another device into the same outlet to confirm the outlet is working.
iPod does not dock properly	Using no/wrong iPod Adaptor.	Make sure the dock insert is the proper fit for your iPod.
	iPod does not install properly.	Remove your iPod from the dock and check for obstruction on the connectors in the dock and on your iPod. Then reseat it in the dock.
iPod does not respond to the speaker system	iPod is not installed properly.	Remove your iPod from the dock and check for obstruction on the connectors in the dock and on your iPod. Then reseat it on the dock.
	Your iPod is locked up.	Please make sure that your iPod is working properly before docking into the unit. Please refer to your iPod manual for info on resetting the iPod.
	iPod mode is not selected.	Slide the <b>Audio Input Selection</b> switch at the back of the unit to iPod position.
iPod does not charge up	iPod is not installed properly.	Remove your iPod from the dock and check for obstruction on the connectors in the dock and on your iPod. Then reseat it in the dock.
	iPod is locked up/ frozen. iPod battery has problem.	Please make sure your iPod is working properly before docking into the unit. Please refer to your iPod manual for details on resetting.
Sound is distorted	Volume level is set too high.	Decrease the volume.
	Sound source is distorted.	If the iPod original sound source is of poor quality, distortion and noise are easily noticed with high-power speakers. Try a different audio source such as a music CD.  If you are using an external sound source like older generation of iPod, try reducing the output volume on the device itself. Also try turning bass boost OFF or change the EQ setting.
Unit gets warm after extended play at high volume	This is normal.	Turn the unit off for a period of time or lower volume.



## SPECIFICATIONS

### Power Requirement

Main unit  
DC input : DC 15V, 1100 mA

Remote Control 2x DC1.5V "AAA" (UM-4) Batteries

**Frequency Response** 100 - 16000Hz

**Total Power Output** 10Wmax

## SERVICE

Please refer to the instructions on the enclosed warranty card for returning your unit for service. When returning the unit, please remove batteries to prevent damage to the unit in transit and/or from possible leakage. We are not responsible for batteries returned with the product or for the cost of replacement.

Distributed by:  
SPECTRA Merchandising International, Inc.  
Chicago Industry Tech Park  
4230 North Normandy Avenue  
Chicago, IL 60634, U.S.A.

Please have model number ready, for Customer Service, call 1-800-777-5331.

\*The specification and external appearance of the set are subject to change without prior notice.\*

Printed in China

## Free Manuals Download Website

<http://myh66.com>

<http://usermanuals.us>

<http://www.somanuals.com>

<http://www.4manuals.cc>

<http://www.manual-lib.com>

<http://www.404manual.com>

<http://www.luxmanual.com>

<http://aubethermostatmanual.com>

Golf course search by state

<http://golfingnear.com>

Email search by domain

<http://emailbydomain.com>

Auto manuals search

<http://auto.somanuals.com>

TV manuals search

<http://tv.somanuals.com>