



OWNER'S MANUAL DC-1200A Dust Collector



JET EQUIPMENT & TOOLS, INC.
A WMH Company
www.jettools.com

P.O. BOX 1349
Auburn, WA 98071-1349
e-mail jet@jettools.com

Phone:253-351-6000
Fax: 1-800-274-6840
M-708634 04/01

This manual has been prepared for the owner and operators of JET'S DC-1200A. Its purpose, aside from machine operation, is to promote safety through the use of accepted correct operating and maintenance procedures. Completely read the safety and maintenance instructions before operating or servicing the machine. To obtain maximum life and efficiency from your Dust Collector, and to aid in using the machine safely, read this manual thoroughly and follow instructions carefully.

Warranty & Service

The JET Group warrants every product it sells. If one of our tools needs service or repair, one of our Authorized Repair Stations located throughout the United States can give you quick service.

In most cases, any one of these JET Group Repair Stations can authorize warranty repair, assist you in obtaining parts, or perform routine maintenance and major repair on your JET, Performax or Powermatic tools.

For the name of an Authorized Repair Station in your area, please call 1-800-274-6848.

More Information

Remember, the JET Group is consistently adding new products to the line. For complete, up-to-date product information, check with your local JET Group distributor.

JET Group Warranty

The JET Group (including Performax and Powermatic brands) makes every effort to assure that its products meet high quality and durability standards and warrants to the original retail consumer/purchaser of our products that each product be free from defects in materials and workmanship as follow: 1 YEAR LIMITED WARRANTY ON ALL PRODUCTS UNLESS SPECIFIED OTHERWISE. This Warranty does not apply to defects due directly or indirectly to misuse, abuse, negligence or accidents, normal wear-and-tear, repair or alterations outside our facilities, or to a lack of maintenance.

THE JET GROUP LIMITS ALL IMPLIED WARRANTIES TO THE PERIOD SPECIFIED ABOVE, FROM THE DATE THE PRODUCT WAS PURCHASED AT RETAIL. EXCEPT AS STATED HEREIN, ANY IMPLIED WARRANTIES OR MERCHANTABILITY AND FITNESS ARE EXCLUDED. SOME STATES DO NOT ALLOW LIMITATIONS ON HOW LONG THE IMPLIED WARRANTY LASTS, SO THE ABOVE LIMITATION MAY NOT APPLY TO YOU. THE JET GROUP SHALL IN NO EVENT BE LIABLE FOR DEATH, INJURIES TO PERSONS OR PROPERTY, OR FOR INCIDENTAL, CONTINGENT, SPECIAL, OR CONSEQUENTIAL DAMAGES ARISING FROM THE USE OF OUR PRODUCTS. SOME STATES DO NOT ALLOW THE EXCLUSION OR LIMITATION OF INCIDENTAL OR CONSEQUENTIAL DAMAGES, SO THE ABOVE LIMITATION OR EXCLUSION MAY NOT APPLY TO YOU.

To take advantage of this warranty, the product or part must be returned for examination, postage prepaid, to an Authorized Repair Station designated by our office. Proof of purchase date and an explanation of the complaint must accompany the merchandise. If our inspection discloses a defect, we will either repair or replace the product, or refund the purchase price if we cannot readily and quickly provide a repair or replacement, if you are willing to accept a refund. We will return repaired product or replacement at JET'S expense, but if it is determined there is no defect, or that the defect resulted from causes not within the scope of JET'S warranty, then the user must bear the cost of storing and returning the product. This warranty gives you specific legal rights; you may also have other rights which vary from state to state.

The JET Group sells through distributors only. Members of the JET Group reserve the right to effect at any time, without prior notice, those alterations to parts, fittings, and accessory equipment which they may deem necessary for any reason whatsoever.

WARNING

1. **Read and understand the entire contents of this manual before attempting assembly or operation. Do not use this machine until proper training and knowledge has been obtained.**
2. Do not leave Dust Collector when plugged in. Unplug from outlet when not in use and before servicing.
3. Do not use outdoors or on wet surfaces.
4. Do not allow to be used as a toy. Close attention is necessary when used near children.
5. Use only as described in this manual. Use only manufacturer's recommended attachments.
6. Do not use with damaged cord or plug. If Dust Collector is not working as it should, has been dropped, damaged, left outdoor, or dropped in water, return it to a service center.
7. Do not pull or carry by cord, use cord as a handle, close a door on cord, or pull cord around sharp edges or corners. Do not run Dust Collector over cord. Keep cord away from heated surfaces.
8. Do not unplug by pulling on cord. To unplug, grasp the plug, not the cord.
9. Do not handle plug or Dust Collector with wet hands.
10. Do not put any objects into the openings. Do not use with any opening blocked; keep free of dust, lint, hair, and anything that may reduce air flow.
11. Keep hair, loose clothing, fingers, and all parts of body away from opening and moving parts.
12. Do not pick up anything that is burning or smoking, such as cigarettes, matches, or hot ashes.
13. Do not use without dust bag and/or filters in place.
14. Turn off all controls before unplugging.
15. Use extra care when cleaning on stairs.
16. Do not use to pick up flammable or combustible liquids such as gasoline or use in areas where they may be present.
17. Do not operate without hose connected to the hose inlet. Hazardous moving parts inside. Unplug before removing hose inlet or inlet guard.
18. Some dust created by power sanding, sawing, grinding, drilling and other construction activities contains chemicals known to cause cancer, birth defects or other reproductive harm. Some examples of these chemicals are:
 - Lead from lead based paint
 - Crystalline silica from bricks and cement and other masonry products, and
 - Arsenic and chromium from chemically-treated lumber.
19. Your risk from those exposures varies, depending on how often you do this type of work. To reduce your exposure to these chemicals: work in a well ventilated area, and work with approved safety equipment, such as those dust masks that are specifically designed to filter out microscopic particles
20. Do not operate tool while under the influence of drugs, alcohol or any medication.
21. Make sure the extension cord is in good condition. When using an extension cord, be sure to use one heavy enough to carry the current your product will draw. An undersize cord will cause a drop in the line voltage resulting in loss of power and overheating. The table below shows the correct size to use depending on cord length and nameplate ampere rating. If in doubt, use the next heavier gauge. The smaller gauge number, the heavier the cord.

Cord Length

25'
50'
100'
150'

Cord Gauge

16 AWG
16 AWG
14 AWG
12 AWG

SAVE THESE INSTRUCTIONS

Specifications:**DC-1200A-1****DC-1200A-3**

Stock Number.....	708634	708635
Blower Wheel Diameter.....	12"	12"
Sound Rating at 3 feet.....	80-85 db	80-85 db
Hose Diameter.....	4" & 6"	4" & 6"
Air Flow (CFM)	1,200	1,200
Velocity at 4" (FPM).....	13,745	13,745
Static Pressure (inch of water)	11.44	11.44
Bag Diameter	20".....	20".....
Bag Length	31-1/2"	31-1/2"
Collector Bag Capacity (cu. ft.)	5.6.....	5.6.....
Overall Dimensions 30 Micron	37"L x 28"W x 79"H.....	37"L x 28"W x 79"H.....
Overall Dimensions 5 Micron	37"L x 28"W x 96"H.....	37"L x 28"W x 96"H.....
Motor (TEFC)	2 HP, 1Ph 230V only	2 HP, 3Ph 230V/460V.....
.....	Prewired 230V
Net Weight (approx.)	108 lbs.....	108 lbs.....

Table of Contents**Page**

Warranty	2
Warnings.....	3
Grounding Instructions.....	4
Specifications	4
Table of Contents	4
Unpacking DC-1200A	5
Contents of Shipping Carton	5
Tools Required for Assembly	5
Assembly.....	6-8
Electrical Connections	8
Turning the Machine On & Off	8
Maintenance.....	9
Parts Breakdown and Parts List	10-11
Wiring Diagrams.....	12

The specifications in this manual are given as general information and are not binding. JET Equipment & Tools reserves the right to effect, at any time and without prior notice, changes or alterations to parts, fittings, and accessory equipment deemed necessary for any reason whatsoever.

⚠ WARNING

**Read and understand the entire contents of this manual before attempting assembly or operation of the dust collector!
Failure to comply may cause serious injury!**

Unpacking

1. Finish removing all contents from the shipping carton.
2. Report any damage to your distributor.
3. Do not discard any shipping material until after the dust collector has been assembled and is running properly.



Contents of the Shipping Carton

- 1 Bag Hanger
- 1 Base
- 1 Plastic Cover
- 1 Hanger Bracket
- 1 Hose
- 1 Owner's Manual
- 1 Warranty Card
- 1 Motor/Fan Assembly
- 1 Collector Bag
- 1 Filter Bag
- 2 Hose Clamps
- 1 Retainer Strap
- 4 Casters
- 1 Inlet Cover & Hose Inlet
- 3 Support Legs
- 1 Bag of Assembly Hardware

1

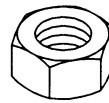

2

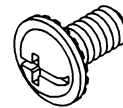

3

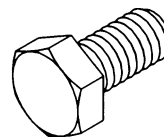

4

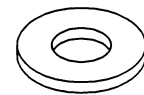

Tools Required for Assembly

2. 1/2" or 13mm Wrenches or sockets
1. 9/16" or 14mm Wrench or socket
1. #2 Cross Point Screw Driver

Assembly

1. Install four casters to the under side of the base as pictured in Fig. 1. Thread the hex nut (B, Fig. 1) onto the caster shaft. Then slide the lock washer (A, Fig. 1) over the caster shaft. Thread the caster shaft into the threaded hole on the underside of the base, turn until snug. Tighten the nut (B, Fig. 1) against the base with a 9/16" or 14mm wrench. This will give the caster proper clearance.

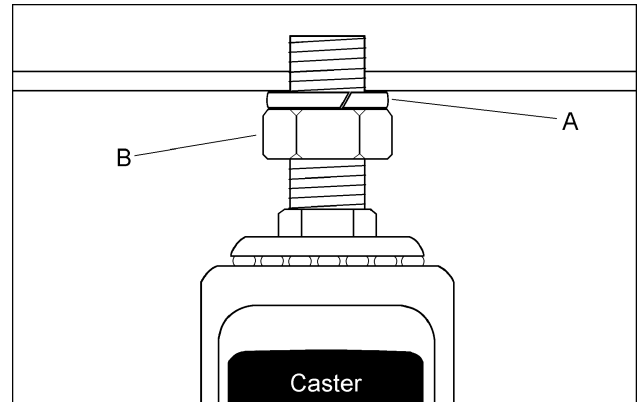

Fig. 1

2. Place the base with casters on the ground. Attach the motor and fan assembly (A, Fig. 2) to the base using four M8 x 16 hex cap bolts, four M8 flat washers (B, Fig. 2), and a 1/2" or 13mm wrench.

⚠ WARNING
The dust collector must be disconnected from the power source during assembly. Failure to comply may result in serious injury!

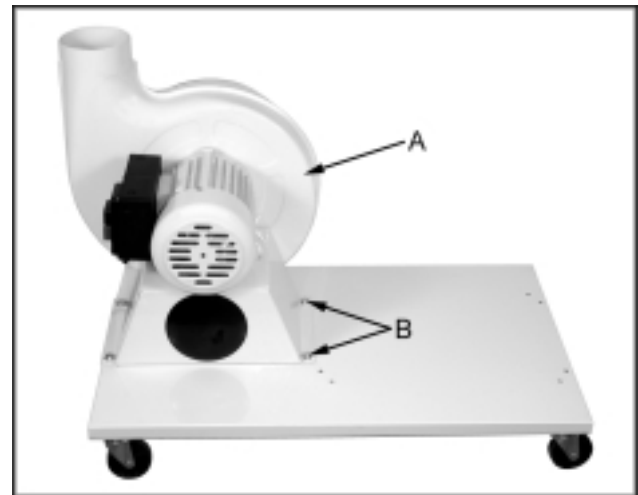

Fig. 2

3. Attach inlet guard (A, Fig. 3) to fan housing using eight M5 x 12 pan head screws (B, Fig. 3). Press the inlet ports onto the inlet guard until it snaps into place.

⚠ WARNING
To reduce the risk of injury from moving parts, always keep inlet ports covered with the caps provided, if they are not connected to a flexible hose. Failure to comply may result in serious injury!

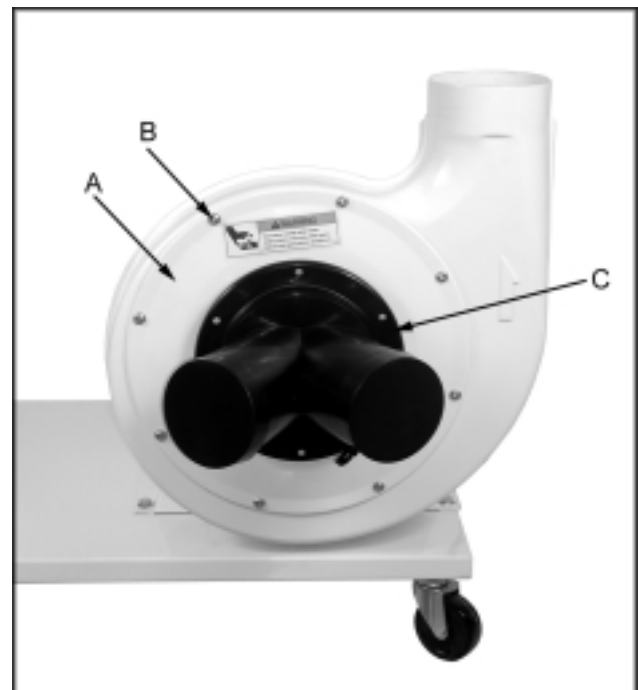

Fig. 3

4. Attach three support brackets (A, Fig. 4) to the base using six M8 x 16 hex cap bolts and six M8 flat washers (B, Fig. 4). Hand tighten only at this time.

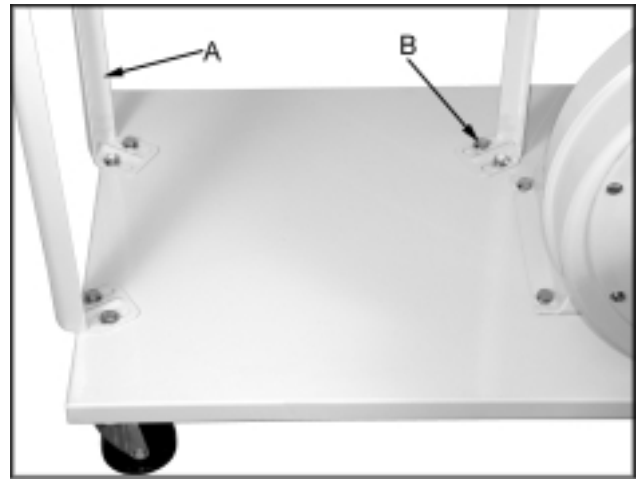

Fig. 4

5. Install the housing (A, Fig. 5) to two support brackets using four M8 x 16 hex cap bolts, eight M8 flat washers, and four M8 hex nuts (B, Fig.5). Be sure hose opening faces fan housing. Before attaching third support bracket place the hanger bracket (C, Fig.5) between the support bracket and the housing. Tighten all nuts and bolts at this time with a 1/2" or 13mm wrench.



Fig. 5

6. Attach the hose (A, Fig. 6) between the fan housing and the collector housing with two clamps (B, Fig. 6). Tighten the clamps to secure the hose.



Fig. 6

- Slide the bag hanger hook (A, Fig. 7) through the top loop of the filter bag. Insert the hanger into the hanger bracket. Thread the retainer strap (B, Fig. 7) through the loops on the filter bag (C, Fig.7), and fasten to the collector housing. The retainer strap should be tight enough to provide a good seal.
- Insert the ring (A, Fig. 8) of the collector bag into the bottom of the housing at an angle. Pull down on the bag to make sure it "seats" in the housing.

Electrical Connections

WARNING

All electrical connections must be done by a qualified electrician. All adjustments or repairs must be done with the dust collector disconnected from the power source, unplugged. Failure to comply may result in serious injury!

The DC-1200A-1 dust collector is rated at **230V Only**. The DC-1200A-3 is rated at 3 Phase 230V/460V, **Prewired 230V**.

If you want to run the DC-1200A-3 on 460V refer to the wiring diagram found on the inside of the switch box cover.

Before hooking up to the power source, make sure that the switch is in the off position.

Turning the Machine On & Off

Before hooking up to the power source, make sure that the switch is in the off position.

The dust collector can be turned on by pressing the start button found on the motor. Press the stop button to turn off the dust collector.



Fig. 7



Fig. 8

Maintenance

WARNING

Never perform maintenance on this machine before turning switch off and removing plug from power source, unplug. Failure to comply may cause serious injury!

Cleaning the Filter Bag

CAUTION

Wearing a particle mask/respirator for protection against fine dust particles during cleaning is highly recommended.

During first use and after cleaning, the filter bag may allow some dust to escape. This is normal and will stop after a short period of time.

Clean both the filter and collector bags frequently to keep the collector's performance at its optimum. To clean:

1. **Disconnect the machine from the power source.**
2. Unhook the filter bag from the hanger and shake the bag so that the majority of the dust falls into the collector bag.
3. Loosen the retaining strap, and remove the filter bag from the housing.
4. Turn the bag inside out and clean.
5. Turn the bag outside in and re-attach to the housing using the retainer strap to secure.

Removing the Collector Bag

1. **Disconnect the machine from the power source, unplug.**
2. Remove the collector bag by pushing the ring of the collector bag upwards and pulling the bag out at an angle.
3. Empty the contents into an appropriate container.
4. Turn the bag inside out and clean.
5. Turn the bag outside in and insert into the housing.

Use the proper type hose to connect the dust collector to the machine being operated. Dryer vent hose is not acceptable for this purpose. Contact your nearest JET distributor for the full line of JET Dust Collector Hoses and Accessories. Customize your installation and obtain maximum performance with JET's dust hoods, hoses, clamps, fittings, and blast gates. Accessories.

Motor

Make frequent inspections of the motor fan and blow out (with low pressure air hose) or vacuum any accumulation of foreign material in order to maintain normal motor ventilation.

Parts Breakdown

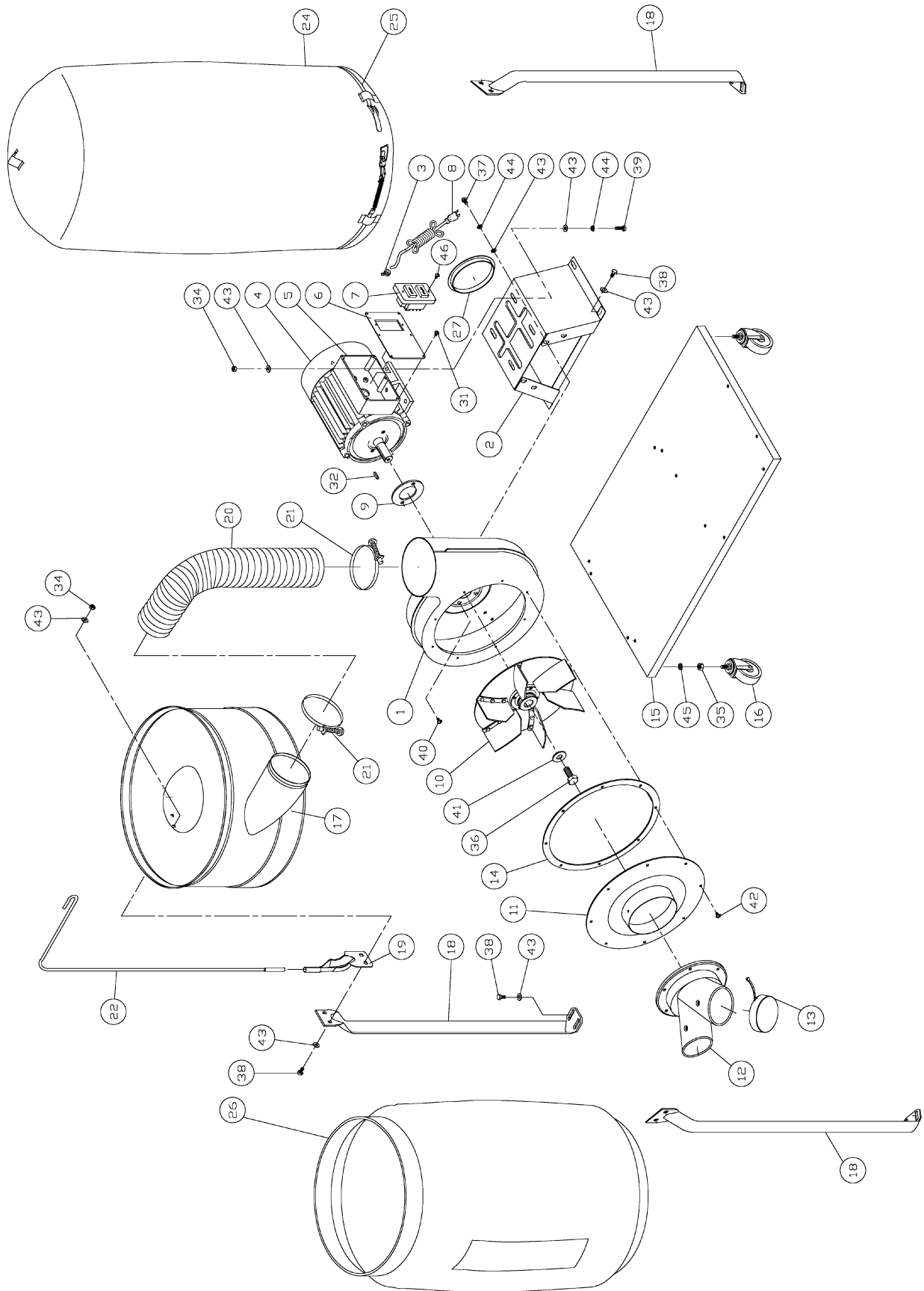

Parts List for the DC-1200A

Index No.	Part No.	Description	Size	Qty.
1	411035W	Impeller Housing		1
2	411026W	Motor Bracket		1
3	998621	Strain Relief		1
4	MA411003	Motor	2 HP, 1Ph	1
	MA411003-3	Motor	2 HP, 3 Ph	1
	DC1100-50W	Motor Fan Cover (not shown)		1
	MF411012	Motor Fan (not shown)		1
	CA003030	Running Capacitor (not shown)	30MFD, 300V	1
	CA020010	Starting Capacitor (not shown)	200MFD, 125V	1
5	411051	Switch Box		1
6	411053	Switch Plate		1
7	994542	Switch	1 Ph	1
	DC1900-23B	Switch	3 Ph	1
8	IC420002	Power Cord		1
9	420051	Motor Packing		1
10	AB411059	Impeller	12"	1
11	411036W	Inlet Guard		1
12	427028	Inlet Port	2 @ 4"	1
13	420203	Inlet Cap		2
14	430034	Inlet Flange Packing		1
15	411041W	Base		1
16	402036	Pivoting Caster		4
17	420012W	Housing		1
18	402004W	Support		3
19	523011W	Hanger Bracket		1
20	411009	Hose	5"x65(CM)	1
21	420010	Ring Clamp	5"	2
22	402040	Hanger	30 Micron Bag Hanger	1
	AB430039	Hanger	5 Micron Bag Hanger	1
24	708698	Filter Bag	30 Micron Bag	1
	708702	Filter Bag	5 Micon Bag	1
25	AB410012	Retainer Strap		1
26	708699A	Collection Bag		1
27	450038	Bracket Cap		1
31	ST039304	Tapping Screw	M3.5x12(AB)	6
32	KS050525	Key	5x5x25	1
34	TS-1540061	Nut	M8	10
35	TS-0561031	Nut	3/8"-16UNC	4
36	SH080402	Hex Head Bolt	M8x20 L.H	1
37	TS-1490011	Hex Head Bolt	M8x12	4
38	TS-1490021	Hex Head Bolt	M8x16	16
39	TS-1490041	Hex Head Bolt	M8x25	4
40	TS-1554041	Pan Head Bolt W/Flange	M6x12	2
41	TS-0680031	Flat Washer	M8	1
42	TS-1554041	Pan Head Bolt W/Flange	M6x12	8
43	TS-0680031	Flat Washer	M8	34
44	TS-0720081	Spring Washer	M8	8
45	TS-1551071	Spring Washer	M10	4
46	ST059304	Tapping Screw	M5x12	2
	DC1200-53	Grounding Label (not shown)		1
	DC1200-54	Direction Label (not shown)		1
	DC1200A-NP	Name Plate (not shown)		1
	DC1100-HP	Hardware Package (not shown)		1
	DC1200A-CS	Centrifugal Switch (not shown)		1
	DC1900-53	Warning Label (not shown)		1

Wiring Diagram For 3 Phase 230V/460V Dust Collector

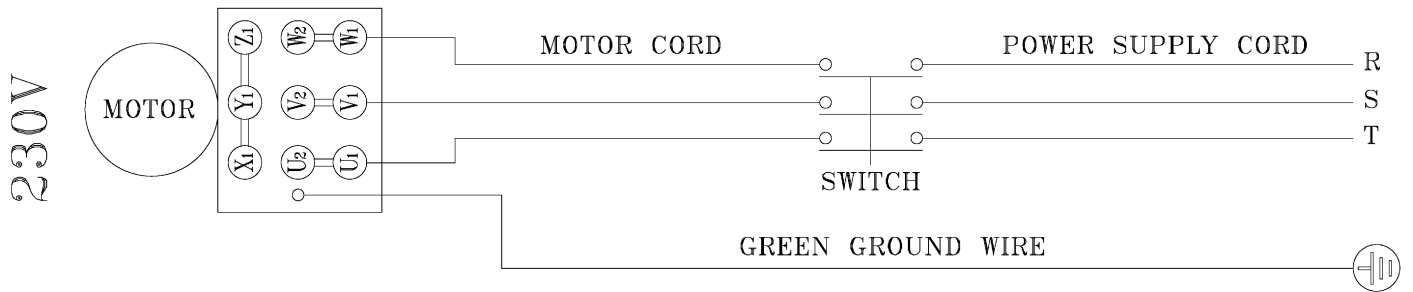
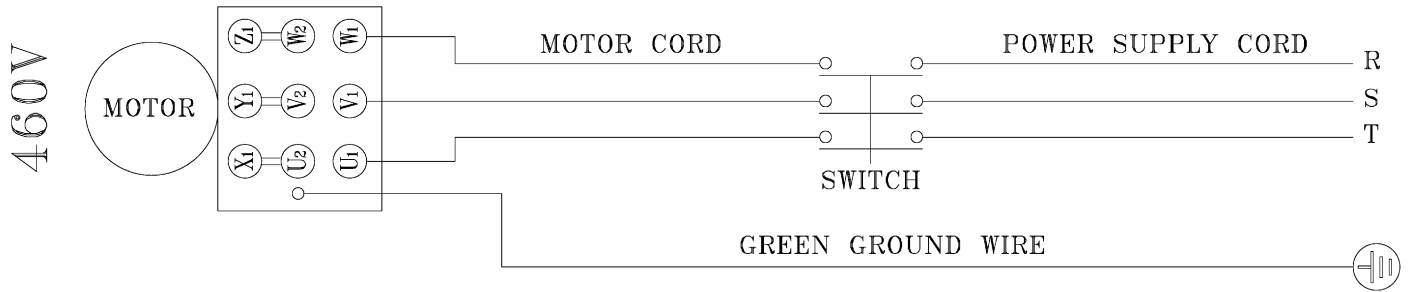

Wiring Diagram For Single Phase 230V Only Dust Collector

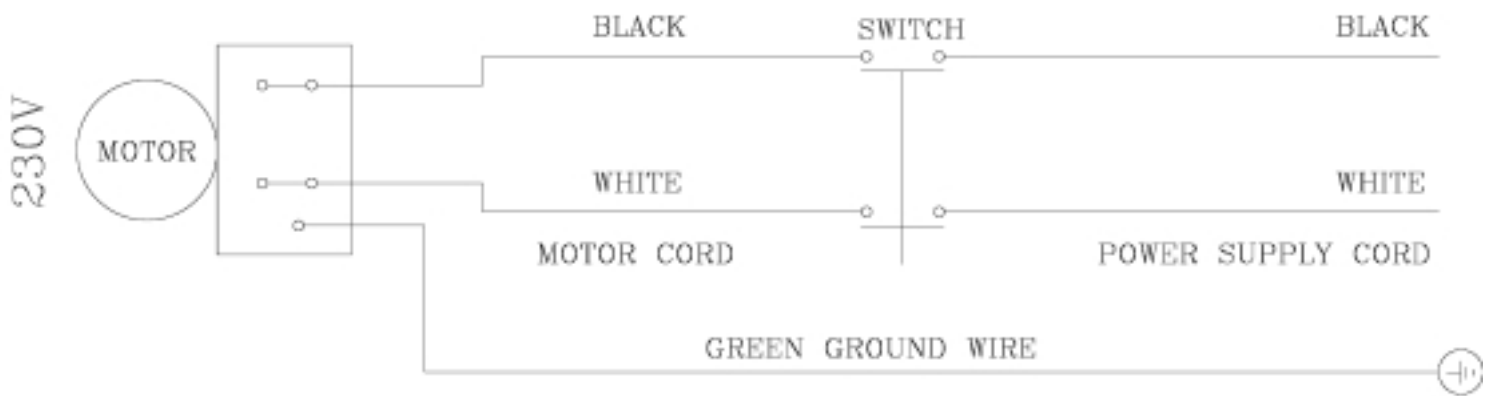

Free Manuals Download Website

<http://myh66.com>

<http://usermanuals.us>

<http://www.somanuals.com>

<http://www.4manuals.cc>

<http://www.manual-lib.com>

<http://www.404manual.com>

<http://www.luxmanual.com>

<http://aubethermostatmanual.com>

Golf course search by state

<http://golfingnear.com>

Email search by domain

<http://emailbydomain.com>

Auto manuals search

<http://auto.somanuals.com>

TV manuals search

<http://tv.somanuals.com>