



OWNER'S MANUAL DC-1200C Dust Collector



JET EQUIPMENT & TOOLS, INC.
A WMH Company
www.jettools.com

P.O. BOX 1349
Auburn, WA 98071-1349
e-mail jet@jettools.com

Phone:253-351-6000
Fax: 1-800-274-6840
M-708634C 1/02

This manual has been prepared for the owner and operators of JET'S DC-1200C. Its purpose, aside from machine operation, is to promote safety through the use of accepted correct operating and maintenance procedures. Completely read the safety and maintenance instructions before operating or servicing the machine. To obtain maximum life and efficiency from your Dust Collector, and to aid in using the machine safely, read this manual thoroughly and follow instructions carefully.

Warranty & Service

The JET Group warrants every product it sells. If one of our tools needs service or repair, one of our Authorized Repair Stations located throughout the United States can give you quick service.

In most cases, any one of these JET Group Repair Stations can authorize warranty repair, assist you in obtaining parts, or perform routine maintenance and major repair on your JET, Performax or Powermatic tools.

For the name of an Authorized Repair Station in your area, please call 1-800-274-6848.

More Information

Remember, the JET Group is consistently adding new products to the line. For complete, up-to-date product information, check with your local JET Group distributor.

JET Group Warranty

The JET Group (including Performax and Powermatic brands) makes every effort to assure that its products meet high quality and durability standards and warrants to the original retail consumer/purchaser of our products that each product be free from defects in materials and workmanship as follow: 1 YEAR LIMITED WARRANTY ON ALL PRODUCTS UNLESS SPECIFIED OTHERWISE. This Warranty does not apply to defects due directly or indirectly to misuse, abuse, negligence or accidents, normal wear-and-tear, repair or alterations outside our facilities, or to a lack of maintenance.

THE JET GROUP LIMITS ALL IMPLIED WARRANTIES TO THE PERIOD SPECIFIED ABOVE, FROM THE DATE THE PRODUCT WAS PURCHASED AT RETAIL. EXCEPT AS STATED HEREIN, ANY IMPLIED WARRANTIES OR MERCHANTABILITY AND FITNESS ARE EXCLUDED. SOME STATES DO NOT ALLOW LIMITATIONS ON HOW LONG THE IMPLIED WARRANTY LASTS, SO THE ABOVE LIMITATION MAY NOT APPLY TO YOU. THE JET GROUP SHALL IN NO EVENT BE LIABLE FOR DEATH, INJURIES TO PERSONS OR PROPERTY, OR FOR INCIDENTAL, CONTINGENT, SPECIAL, OR CONSEQUENTIAL DAMAGES ARISING FROM THE USE OF OUR PRODUCTS. SOME STATES DO NOT ALLOW THE EXCLUSION OR LIMITATION OF INCIDENTAL OR CONSEQUENTIAL DAMAGES, SO THE ABOVE LIMITATION OR EXCLUSION MAY NOT APPLY TO YOU.

To take advantage of this warranty, the product or part must be returned for examination, postage prepaid, to an Authorized Repair Station designated by our office. Proof of purchase date and an explanation of the complaint must accompany the merchandise. If our inspection discloses a defect, we will either repair or replace the product, or refund the purchase price if we cannot readily and quickly provide a repair or replacement, if you are willing to accept a refund. We will return repaired product or replacement at JET'S expense, but if it is determined there is no defect, or that the defect resulted from causes not within the scope of JET'S warranty, then the user must bear the cost of storing and returning the product. This warranty gives you specific legal rights; you may also have other rights which vary from state to state.

The JET Group sells through distributors only. Members of the JET Group reserve the right to effect at any time, without prior notice, those alterations to parts, fittings, and accessory equipment which they may deem necessary for any reason whatsoever.

WARNING

1. **Read and understand the entire contents of this manual before attempting assembly or operation. Do not use this machine until proper training and knowledge has been obtained.**
2. Do not leave Dust Collector when plugged in. Unplug from outlet when not in use and before servicing.
3. Do not use outdoors or on wet surfaces.
4. Do not allow to be used as a toy. Close attention is necessary when used near children.
5. Use only as described in this manual. Use only manufacturer's recommended attachments.
6. Do not use with damaged cord or plug. If Dust Collector is not working as it should, has been dropped, damaged, left outdoor, or dropped in water, return it to a service center.
7. Do not pull or carry by cord, use cord as a handle, close a door on cord, or pull cord around sharp edges or corners. Do not run Dust Collector over cord. Keep cord away from heated surfaces.
8. Do not unplug by pulling on cord. To unplug, grasp the plug, not the cord.
9. Do not handle plug or Dust Collector with wet hands.
10. Do not put any objects into the openings. Do not use with any opening blocked; keep free of dust, lint, hair, and anything that may reduce air flow.
11. Keep hair, loose clothing, fingers, and all parts of body away from opening and moving parts.
12. Do not pick up anything that is burning or smoking, such as cigarettes, matches, or hot ashes.
13. Do not use without dust bag and/or filters in place.
14. Turn off all controls before unplugging.
15. Do not use to pick up flammable or combustible liquids such as gasoline or use in areas where they may be present.
16. Do not operate without hose connected to the inlet ports or covered by an inlet cap. Hazardous moving parts inside. Unplug machine before removing inlet port, inlet cap, hose, or inlet guard.
17. Use the inlet caps to cover the inlet port openings that are not connected to hoses.
18. Some dust created by power sanding, sawing, grinding, drilling and other construction activities contains chemicals known to cause cancer, birth defects or other reproductive harm. Some examples of these chemicals are:
 - Lead from lead based paint
 - Crystalline silica from bricks and cement and other masonry products, and
 - Arsenic and chromium from chemically-treated lumber.
19. Your risk from those exposures varies, depending on how often you do this type of work. To reduce your exposure to these chemicals: work in a well ventilated area, and work with approved safety equipment, such as those dust masks that are specifically designed to filter out microscopic particles
20. Do not operate tool while under the influence of drugs, alcohol or any medication.
21. Make sure the extension cord is in good condition. When using an extension cord, be sure to use one heavy enough to carry the current your product will draw. An undersize cord will cause a drop in the line voltage resulting in loss of power and overheating. The table below shows the correct size to use depending on cord length and nameplate ampere rating. If in doubt, use the next heavier gauge. The smaller gauge number, the heavier the cord.
22. Do not use dust collector for anything except wood dust. Materials such as liquids, metal shavings, metal dust, screws, glass, plastic or rock can cause sparks and/or damage when coming into contact with any part of the dust collector.
23. Ground your dust collector along all plastic componets. The connection of bare 12 gauge copper wire on all plastic hoses, fittings and blast gates to all machines will help reduce the occurrence of static build up and discharge.

SAVE THESE INSTRUCTIONS

Specifications:

DC-1200C

Stock Number.....	708634C
Blower Wheel Diameter.....	12"
Sound Rating at 3 feet.....	80-85 db
Hose Diameter.....	4" & 6"
Air Flow (CFM).....	1,200
Velocity at 4" (FPM).....	13,745
Static Pressure (inch of water).....	11.44
Bag Diameter.....	20"
Bag Length.....	45 & 28"
Collector Bag Capacity (cu. ft.).....	5.6
Overall Dimensions 2 Micron	37"L x 28"W x 70-7/8"H
Motor (TEFC).....	.2 HP, 1Ph 230V only
Net Weight (approx.).....	125 lbs.

Table of Contents

Page

Warranty.....	2
Warnings.....	3
Specifications.....	4
Table of Contents.....	4
Unpacking DC-1900.....	5
Contents of Shipping Carton.....	5
Tools Required for Assembly.....	5
Assembly.....	6-8
Electrical Connections.....	9
Turning the Machine On & Off.....	9
Maintenance.....	9
Cleaning the Filter Bag.....	9
Removing the Collector Bag.....	9
Motor.....	9
Connecting the Dust collector to a Machine.....	9
Grounding the Dust Collection System.....	9
Parts Breakdown and Parts List.....	10-12
Wiring Diagrams.....	12

The specifications in this manual are given as general information and are not binding. JET Equipment & Tools reserves the right to effect, at any time and without prior notice, changes or alterations to parts, fittings, and accessory equipment deemed necessary for any reason whatsoever.

⚠ WARNING

**Read and understand the entire contents of this manual before attempting assembly or operation of the dust collector!
Failure to comply may cause serious injury!**

Unpacking

1. Remove all contents from the shipping carton.
2. Report any damage to your distributor.
3. Do not discard any shipping material until after the dust collector has been assembled and is running properly.

Contents of the Shipping Cartons

Canister Filter Box

1. Canister Filter
1. Handle
1. Bag of Hardware for Handles
 2. M10 Hex Nuts
 2. M10 Flat Washers
 1. M10 Lock Washer
 4. Knobs

DC-1200C

1. Base
1. Owner's Manual
1. Warranty Card
1. Motor/Fan Assembly
5. Collector Bags
 1. Snap Rings
 2. Ring Clamps
 4. Casters
 1. Inlet Port & Inlet Caps
3. Support Legs
 1. Housing
 1. Bag of Assembly Hardware
 16. M8 x 16 Hex Cap Bolts
 34. M8 Flat Washers
 8. M6 x 12 Pan Head Flange Bolts
 10. M8 Hex Nuts

Tools Required for Assembly

2. 13mm Wrenches or Sockets
 1. 14mm Wrench or Socket
 1. #2 Cross Point Screw Driver
 1. 17mm Wrench

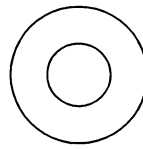

34) M8
Flat Washers

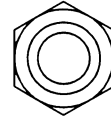

10) M8
Hex Nuts

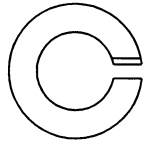

1) M10
Lock Washer

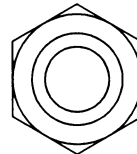

2) M10
Hex Nuts

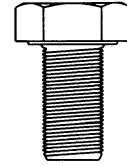

16) M8 x 16
Hex Cap Bolts

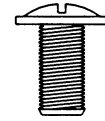

8) M6 x 12
Pan Head Flange Bolts

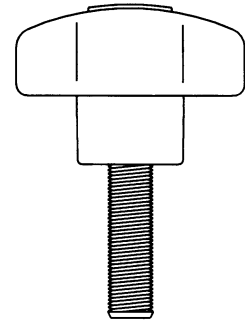

4) M6 x 20
Knobs

Assembly

1. Install *four* casters to the under side of the base as pictured in Fig. 1. Thread the hex nut (B, Fig. 1) onto the caster shaft. Then slide the lock washer (A, Fig. 1) over the caster shaft. Thread the caster shaft into the threaded hole on the underside of the base, turn until snug. Tighten the nut (B, Fig. 1) against the base with a 14mm wrench. This will give the caster proper clearance.

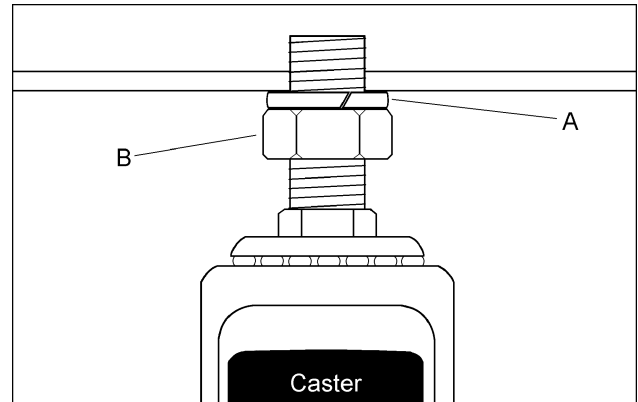

Fig. 1

2. Place the base with casters on the ground. Attach the motor and fan assembly (A, Fig. 2) to the base using *four* M8 x 16 hex cap bolts, *four* M8 flat washers (B, Fig. 2), and a 13mm wrench.

⚠ WARNING
The dust collector must be disconnected from the power source during assembly. Failure to comply may result in serious injury!

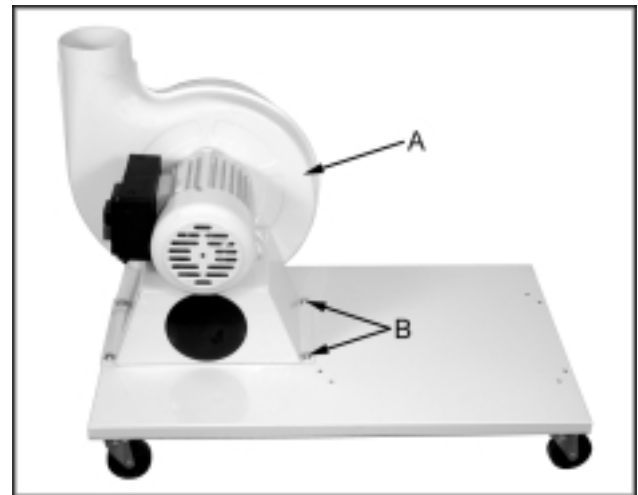

Fig. 2

3. Attach inlet guard (A, Fig. 3) to fan housing using *eight* M5 x 12 pan head screws (B, Fig. 3). Press the inlet port onto the inlet guard until it snaps into place.

⚠ WARNING
To reduce the risk of injury from moving parts, always keep inlet ports covered with the caps provided, if they are not connected to a flexible hose. Failure to comply may result in serious injury!

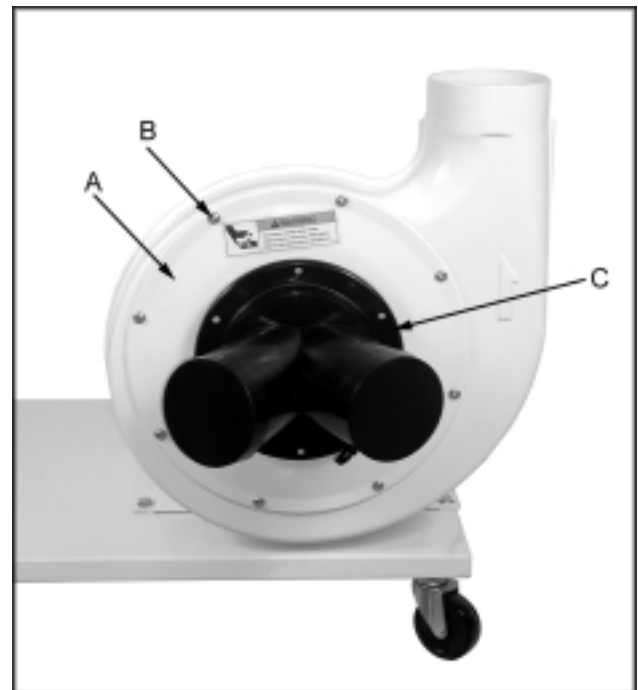

Fig. 3

4. Attach *three* support brackets (A, Fig. 4) to the base using *six* M8 x 16 hex cap bolts and *six* M8 flat washers (B, Fig. 4). Hand tighten only at this time.

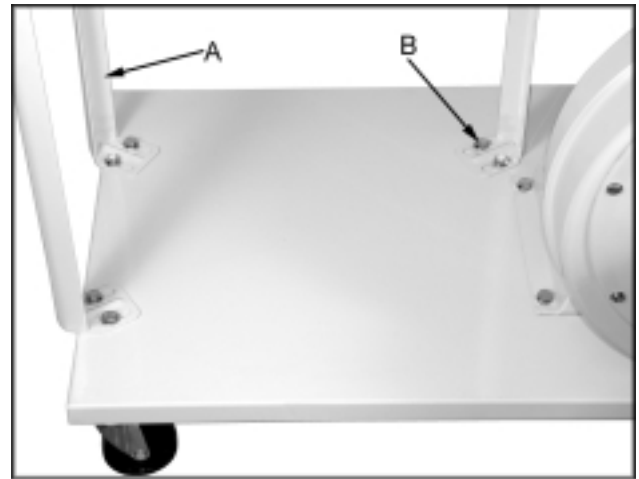

Fig. 4

5. Install the housing (A, Fig. 5) to *two* support brackets using *four* M8 x 16 hex cap bolts, *eight* M8 flat washers, and *four* M8 hex nuts (B, Fig.5). Be sure hose opening faces fan housing. Before attaching third support bracket place the hanger bracket (C, Fig.5) between the support bracket and the housing. Tighten all nuts and bolts at this time with a 13mm wrench.



Fig. 5

6. Attach the hose (A, Fig. 6) between the fan housing and the collector housing with *two* clamps (B, Fig. 6). Tighten the clamps to secure the hose.

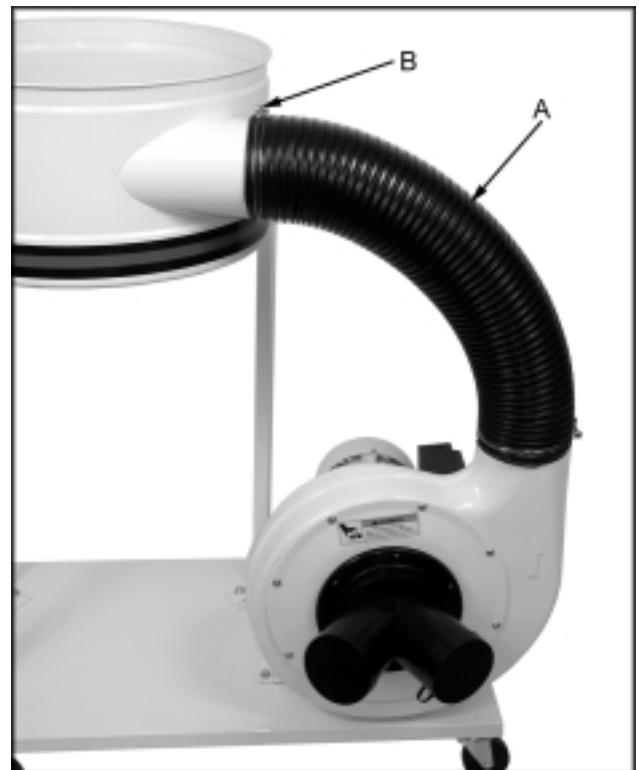

Fig. 6

- Place the ring over the top of the plastic bag and fold over the bag approximately three inches, Figure 7.



Fig. 7

- Insert the snap ring (A, Fig. 8) of the collector bag into the bottom of the housing at an angle.
- Pull down on the ring to make sure it "seats" in the housing.

Note: make sure the snap ring "snaps" into place in the housing, and also that the plastic bag hangs down approximately 3" so that there are no air leaks.



Fig. 8

- Mount the handle onto the canister filter with two M10 hex nuts, two M10 flat washers, and a M10 lock washer, see Figure 9.

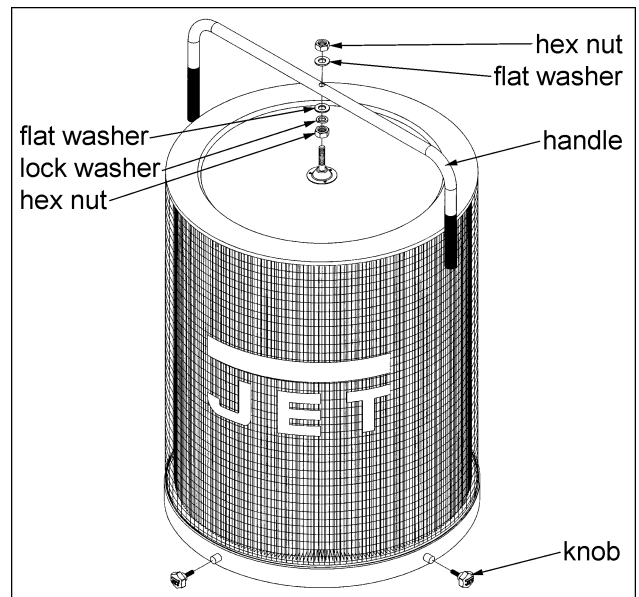

Fig. 9

Electrical Connections

WARNING

All electrical connections must be done by a qualified electrician. All adjustments or repairs must be done with the dust collector disconnected from the power source, unplugged. Failure to comply may result in serious injury!

The DC-1200C dust collector is rated at **230V Only** and is not supplied with a plug. Use a plug and outlet rated at least 20 amps. The circuit for the machine should also be protected by at least a 20 amp circuit breaker or fuse. Keep in mind that a circuit being used by other machines, tools, lights, heaters, etc. at the same time will add to the electrical load. A dedicated circuit to the dust collector will give you the best results since dust collectors are generally used at the same time other tools are running.

Before hooking up to the power source, make sure that the switch is in the off position.

Turning the Machine On & Off

Before hooking up to the power source, make sure that the switch is in the off position.

The dust collector can be turned on by pressing the start button mounted next to the motor. Press the stop button to turn off the dust collector.

Maintenance

WARNING

Never perform maintenance on this machine before turning switch off and removing plug from power source, unplug. Failure to comply may cause serious injury!

Cleaning the Filter

Clean both the filter and collector bag frequently to keep the collector's performance at its optimum.

To clean the filter turn the handle a couple rotations so the dust falls into the collector bag.

Removing the Collector Bag

CAUTION

Wearing a particle mask/respirator for protection against fine dust particles during cleaning is highly recommended.

1. **Disconnect the machine from the power source, unplug.**
2. Remove the collector bag by pushing the ring of the collector bag upwards at an angle and pulling the bag and snap ring out.
3. Empty the contents into an appropriate container.
4. See Page 8 for details on replacing the collector bags.

Motor

Make frequent inspections of the motor fan and blow out (with low pressure air hose) or vacuum any accumulation of foreign material in order to maintain normal motor ventilation.

Connecting the Dust collector to a Machine

Use the proper type hose to connect the dust collector to the machine being operated. Dryer vent hose is not acceptable for this purpose. Contact your nearest JET distributor for the full line of JET Dust Collector Hoses and Accessories. Customize your installation and obtain maximum performance with JET's dust hoods, hoses, clamps, fittings, and blast gates.

You can also purchase the JET *"Dust Collection Basics Video"* stock # JW1050V through your JET Distributor

Grounding the Dust Collection System

The dust collection system includes the dust collector and the hose, or duct work you use to connect the tools. The dust collector is grounded through the ground wire in the cord. The hose or duct work you use to connect the tool to the dust collector must also be grounded. To assist in grounding your system you can purchase the JET *"Dust Collector Grounding Kit"* stock # JW1053, and also the JET *"Dust Collection Basics Video"* stock # JW1050V through JET Distributors.

Parts Breakdown for DC-1200C Dust Collector w/Canister Filter

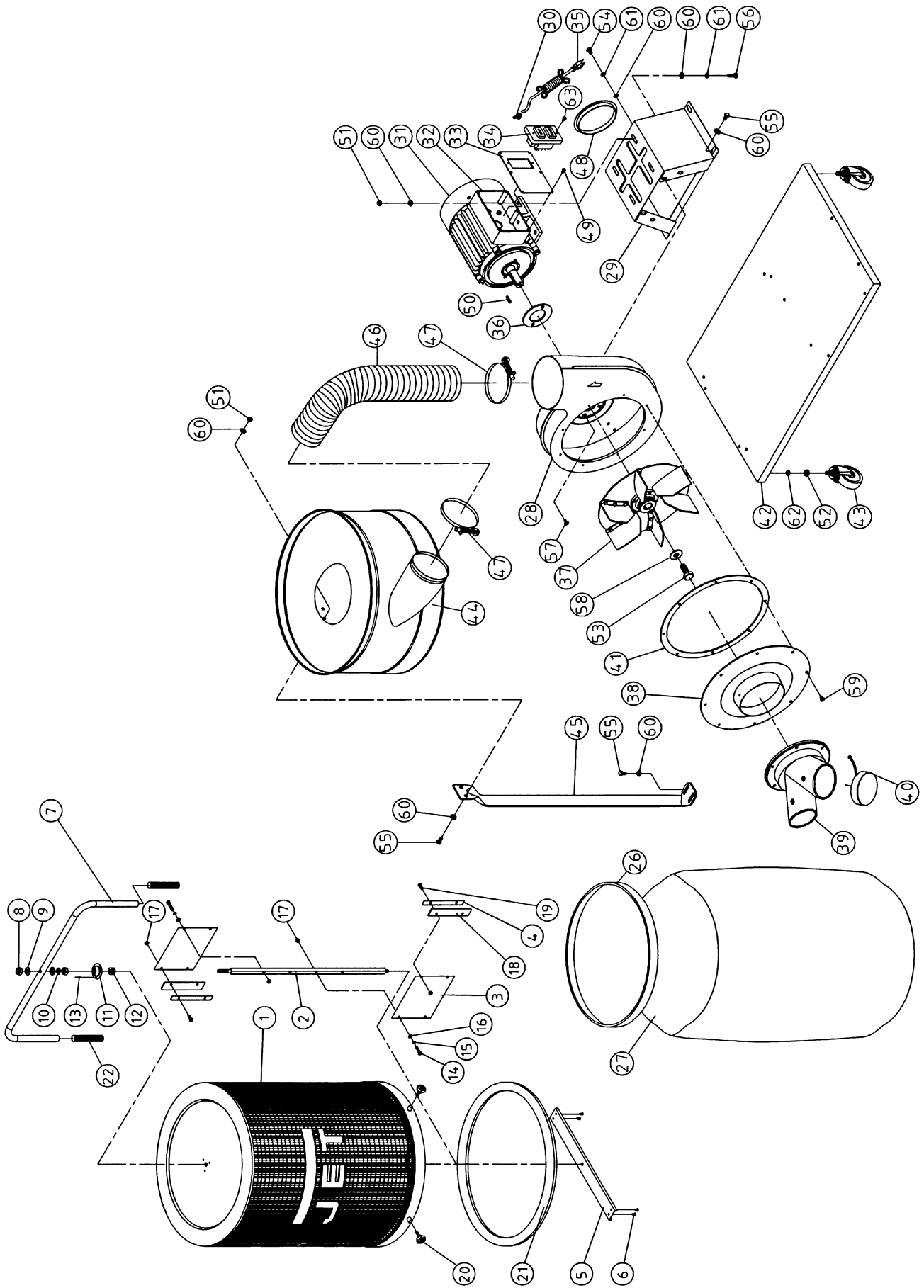

Parts List for the DC-1200C Dust Collector w/Canister Filter

Index No.	Part No.	Description	Size	Qty.
1	708739	Filter		1
2	331010	Shaft		1
3	331012	Scraper		2
4	331015	Plate		2
5	331009	Support		2
6	ST049200	Tapping Screw	M4x8	4
7	331050	Handle		1
8	NH101700	Nut	M10	2
9	WF102025	Flat Washer	M10	2
10	WS100000	Spring Washer	M10	1
11	331014	Bracket		1
12	150623	Pad		1
13	BR000052	Rivet		3
14	SH060400	Hex Head Bolt	M6x20	4
15	WS060000	Spring Washer	M6	4
16	WF061310	Flat Washer	M6	4
17	NH061000	Nut	M6	8
18	331017	Plate		2
19	SH069300	Hex Head Bolt	M6x12	4
20	331037	Knob	M6x20	4
21	331031	Pad		1
22	331051	Soft Grip Handle		2
26	331038	Snap Ring		1
27	998674-36	PVC Bag		5
28	411035W	Impeller Housing		1
29	411026W	Motor Bracket		1
30	998621	Strain Relief		1
31	MA411003	Motor	2 HP, 1Ph	1
	DC1100-50W	Motor Fan Cover (not shown)		1
	MF411012	Motor Fan (not shown)		1
	CA003030	Running Capacitor (not shown)	30MFD, 300V	1
	CA020010	Starting Capacitor (not shown)	200MFD, 125V	1
32	411051	Switch Box		1
33	411053	Switch Plate		1
34	994542	Switch	1 Ph	1
35	IC420002	Power Cord		1
36	420051	Motor Packing		1
37	AB411059	Impeller	12"	1
38	411036W	Inlet Guard		1
39	427028	Inlet Port	2 @ 4"	1
40	420203	Inlet Cap		2
41	430034	Inlet Flange Packing		1
42	411041W	Base		1
43	402036	Pivoting Caster		4
44	420012W	Housing		1
45	402004W	Support		3
46	411009	Hose		1
47	420010	Ring Clamp	5"	2
48	450038	Bracket Cap		1
49	ST039304	Tapping Screw	M3.5x12	6
50	KS050525	Key	5x5x25	1
51	TS-1540061	Nut	M8	10
52	TS-0561031	Nut	3/8"-16UNC	4

Index No.	Part No.	Description	Size	Qty.
53	TS-1490031	Hex Head Bolt	M8x20	1
54	TS-1490011	Hex Head Bolt	M8x12	4
55	TS-1490021	Hex Head Bolt	M8x16	16
56	TS-1490041	Hex Head Bolt	M8x25	4
57	TS-1554041	Pan Head Bolt W/Flange	M6x12	2
58	TS-0680031	Flat Washer	M8	1
59	TS-1554041	Pan Head Bolt W/Flange	M6x12	8
60	TS-0680031	Flat Washer	M8	34
61	TS-0720081	Spring Washer	M8	8
62	TS-1551071	Spring Washer	M10	4
63	ST059304	Tapping Screw	M5x12	2
	DC1200-53	Grounding Label (not shown)		1
	DC1200-54	Direction Label (not shown)		1
	DC1200A-NP	Name Plate (not shown)		1
	DC1100-HP	Hardware Package (not shown)		1
	DC1200A-CS	Centrifugal Switch (not shown)		1
	DC1900-53	Warning Label (not shown)		1

Wiring Diagram For Single Phase 230V Only Dust Collector

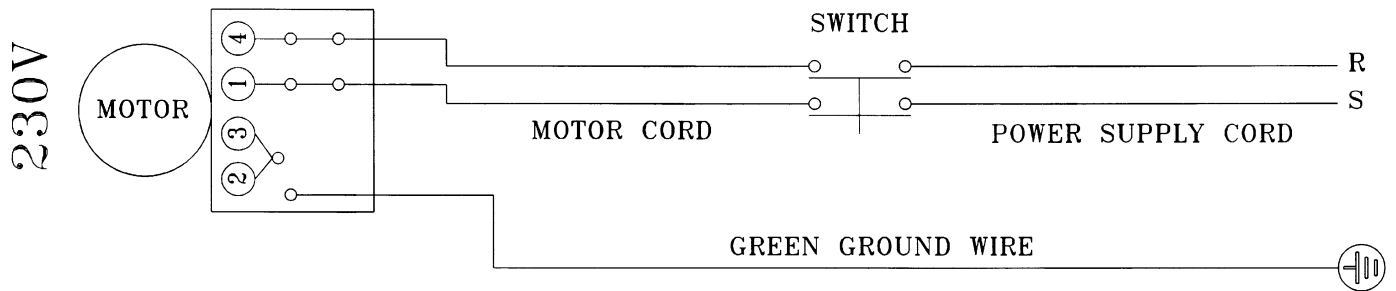

Free Manuals Download Website

<http://myh66.com>

<http://usermanuals.us>

<http://www.somanuals.com>

<http://www.4manuals.cc>

<http://www.manual-lib.com>

<http://www.404manual.com>

<http://www.luxmanual.com>

<http://aubethermostatmanual.com>

Golf course search by state

<http://golfingnear.com>

Email search by domain

<http://emailbydomain.com>

Auto manuals search

<http://auto.somanuals.com>

TV manuals search

<http://tv.somanuals.com>