



DCY

StarFire™ iTC and RTK

OPERATOR'S MANUAL StarFire iTC™ and RTK

OMPC20964 Issue J7 (ENGLISH)

CALIFORNIA
Proposition 65 Warning

Diesel engine exhaust and some of its constituents are known to the State of California to cause cancer, birth defects, and other reproductive harm.

If this product contains a gasoline engine:

 **WARNING**

The engine exhaust from this product contains chemicals known to the State of California to cause cancer, birth defects or other reproductive harm.

The State of California requires the above two warnings.

John Deere Ag Management Solutions
(This manual replaces **OMPC20677**)
European Version
Printed in Germany



OMPC20964

Contents

	Page		Page
Safety	05-1	SETUP-GPS-PAGE 1	25-4
StarFire iTC Receiver		Overview: SF2/RTK Activations, SF2	
StarFire iTC Receiver	10-1	Subscription	25-5
GS2 Display—StarFire iTC		QuickStart Setup	25-8
STARFIRE ITC softkey	15-1	TCM	
INFO tab	15-2	Setup	25-9
SETUP tab	15-4	On/Off	25-9
Correction Mode	15-5	Mount Direction	25-10
Correction Frequency	15-5	Calibrate Level	25-11
Mount Direction	15-5	Height	25-16
Fore/Aft	15-6	Fore/Aft	25-17
Height	15-7	Differential Correction Setup	25-18
QuickStart	15-7	Serial RS232 Output	25-19
Hours On After Shutdown	15-8	Hours On After Shutdown	25-20
TCM Calibration	15-8	INFO - GPS - PAGE 1	25-21
ACTIVATIONS tab	15-12	INFO - GPS - PAGE 2	25-23
SERIAL PORT tab	15-15	Data Log	25-24
NMEA Strings	15-16	INFO - GPS - PAGE 3	25-28
SATELLITE INFORMATION softkey	15-19	Satellite Tracking	25-29
Satellite Predictor	15-23	Original GreenStar Display—RTK	
DIAGNOSTIC softkey	15-24	Operating Mode	30-1
READINGS tab	15-25	Vehicle Repeater	30-3
DATA LOGS tab	15-26	Quick Survey Mode	30-4
Radio Self Test	15-33	Absolute Mode	30-5
StarFire Signal Monitoring System	15-34	Shared Base Station RTK Security	30-8
GS2 Display—RTK		Time Slot	30-12
RTK softkey	20-1	Network ID	30-13
Vehicle	20-3	Repeater	30-14
Vehicle Repeater	20-5	Operating Vehicle	30-15
Quick Survey Mode	20-6	RTK	
Absolute Base Mode	20-6	Info Pages	30-17
RTK Network Configuration	20-9	Info Pages	30-18
Shared Base Station RTK Security	20-11	RTK Base Station Setup	
Shared Base Station Security—Setup	20-12	Country Use Restrictions	35-1
RTK Vehicle Security Status	20-16	System Overview	35-2
Original GreenStar Display—StarFire iTC		Installation of the RTK radio and antenna	35-4
Auto-Update	25-1	Attaching RTK Harness	35-5
Manual Software Update	25-2	RTK Network Base Station Setup	35-6
StarFire Receiver	25-3	Multipathing	35-10

Continued on next page

All information, illustrations and specifications in this manual are based on the latest information available at the time of publication. The right is reserved to make changes at any time without notice.

COPYRIGHT © 2007
DEERE & COMPANY
Moline, Illinois
All rights reserved
A John Deere ILLUSTRATION® Manual

	Page
RTK using Straight, Curves or Circle	35-16
Example A	35-17
Operating Parameters	35-18
PDOP Definition	35-19
PDOP Operating Values.	35-21
StarFire Signal Monitoring System	35-23
Antenna Height.	35-25
Specific Tower Setup Information.	35-26
Utilizing Both The 91 m (300 ft) RTK Extension Harness And Low Loss Coax Cable	35-27
Utilizing The RTK Extension Harness.	35-28
Utilizing A Repeater	35-28
Utilizing Just Low Loss Coax Cable	35-29
Leaving The Radio And Receiver As A Single Unit	35-29
 Troubleshooting and Diagnostics	
Accessing GREENSTAR 2 Diagnostic Addresses.	40-1
Accessing Original GREENSTAR Display Fault Codes	40-3
STARFIRE iTC Diagnostic Addresses	40-4
Fault Codes—StarFire iTC	40-8
Diagnostic Trouble Codes—StarFire iTC	40-11
GreenStar Deluxe - Diagnostic Readings	40-13
 Specifications	
Unified Inch Bolt and Screw Torque Values	45-1
Metric Bolt and Screw Torque Values.	45-2
Declaration of Conformity	45-3
Safety Note Regarding the Subsequent Installation of Electrical and Electronic Appliances and/or Components	45-3

Safety

Recognize Safety Information

This is a safety-alert symbol. When you see this symbol on your machine or in this manual, be alert to the potential for personal injury.

Follow recommended precautions and safe operating practices.



DX,ALERT -19-29SEP98-1/1

T81389 -JUN-07DEC88

Understand Signal Words

A signal word—DANGER, WARNING, or CAUTION—is used with the safety-alert symbol. DANGER identifies the most serious hazards.

DANGER or WARNING safety signs are located near specific hazards. General precautions are listed on CAUTION safety signs. CAUTION also calls attention to safety messages in this manual.



▲ WARNING

▲ CAUTION

DX,SIGNAL -19-03MAR93-1/1

TS187 -19-30SEP88

Follow Safety Instructions

Carefully read all safety messages in this manual and on your machine safety signs. Keep safety signs in good condition. Replace missing or damaged safety signs. Be sure new equipment components and repair parts include the current safety signs. Replacement safety signs are available from your John Deere dealer.

Learn how to operate the machine and how to use controls properly. Do not let anyone operate without instruction.

Keep your machine in proper working condition. Unauthorized modifications to the machine may impair the function and/or safety and affect machine life.

If you do not understand any part of this manual and need assistance, contact your John Deere dealer.



DX,READ -19-03MAR93-1/1

TS201 -JUN-23AUG88

Prepare for Emergencies

Be prepared if a fire starts.

Keep a first aid kit and fire extinguisher handy.

Keep emergency numbers for doctors, ambulance service, hospital, and fire department near your telephone.

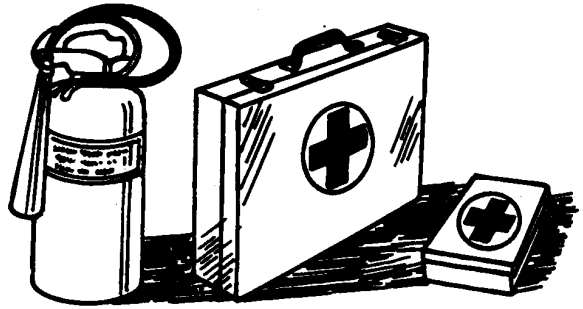

DX.FIRE2 -19-03MAR93-1/1

TS291 -UN-23AUG88

Practice Safe Maintenance

Understand service procedure before doing work. Keep area clean and dry.

Never lubricate, service, or adjust machine while it is moving. Keep hands, feet, and clothing from power-driven parts. Disengage all power and operate controls to relieve pressure. Lower equipment to the ground. Stop the engine. Remove the key. Allow machine to cool.

Securely support any machine elements that must be raised for service work.

Keep all parts in good condition and properly installed. Fix damage immediately. Replace worn or broken parts. Remove any buildup of grease, oil, or debris.

On self-propelled equipment, disconnect battery ground cable (-) before making adjustments on electrical systems or welding on machine.

On towed implements, disconnect wiring harnesses from tractor before servicing electrical system components or welding on machine.



DX.SERV -19-17FEB99-1/1

TS218 -UN-23AUG88

Install and Remove StarFire Receiver and Brackets Safely

When installing and removing the StarFire receiver, follow these guidelines to prevent potential injury from falling:

- Use an appropriate ladder or platform to easily access mounting location.
- Ensure sturdy and secure footholds and handholds.
- Avoid installing or removing receiver in wet or icy conditions.

The receiver mast used on implements is heavy and can be awkward to handle. If installing or removing a receiver mast on an implement, follow these guidelines:

- Use two people for mounting locations not accessible from the ground or a service platform.
- Use proper lifting techniques.
- Wear proper protective equipment.



PC10340 -UN-27SEP07

OUC6050,0000E4D -19-27SEP07-1/1

StarFire iTC Receiver

StarFire iTC Receiver

Receiver is located on cab of machine. It receives global positioning and differential correction signal through a single receiver and integrates signal for use with system.

Terrain Compensation Module (TCM) is integrated into receiver and is a navigational aid used with receiver to enhance vehicle position and course parameters that GPS provides. TCM corrects for vehicle dynamics such as roll on side-slopes, rough terrain or varying soil conditions.

OUC6050,0000C0C -19-18OCT07-1/4

StarFire iTC Mounting Instructions

1. Read "Install and Remove StarFire Receiver and Brackets Safely" in the Safety section.
2. Verify that vehicle side receiver bracket bar (A) is not bent inward or outward.

A—Bracket Bar

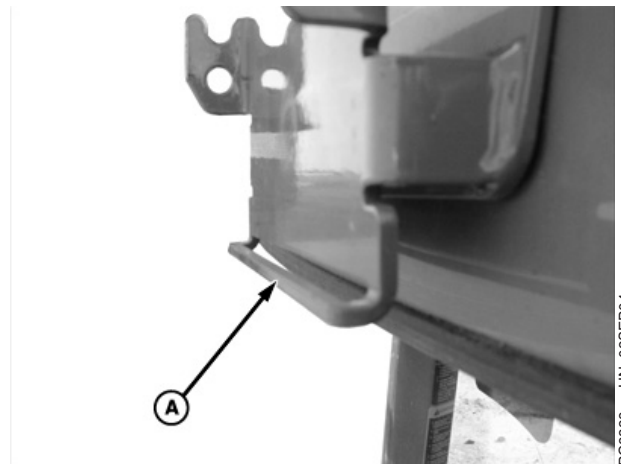

PC8928 -UN-02SEP04

Continued on next page

OUC6050,0000C0C -19-18OCT07-2/4

StarFire iTC Receiver



A—Mounting Peg

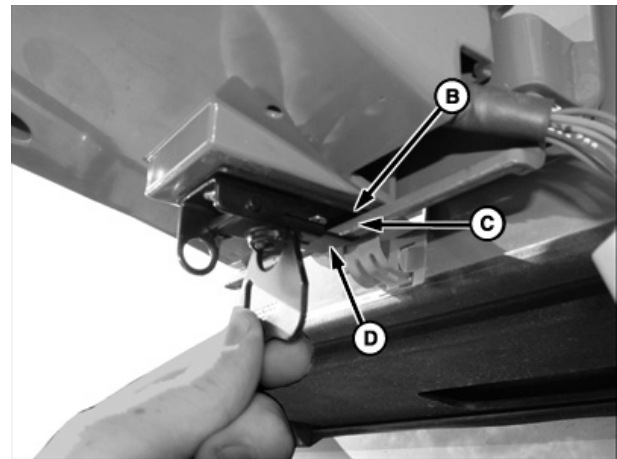

B—Metal Tab

C—Bracket Bar

D—Receiver Latch

3. Position StarFire iTC on bracket. Align mounting pegs (A) on receiver with notches in vehicle bracket. Ensure pegs are firmly seated in notches and metal tab (B) is above bracket bar (C).

4. Position receiver latch (D) around bracket bar. Turn latch handle to tighten latch around bracket bar. Bracket bar should compress slightly.

OUC6050,0000C0C -19-18OCT07-3/4

5. Fold latch handle upwards against receiver.



OUC6050,0000C0C -19-18OCT07-4/4

GS2 Display—StarFire iTC

STARFIRE ITC softkey

The STARFIRE ITC - MAIN screen contains four tabs:

INFO tab

SETUP tab

ACTIVATIONS tab

SERIAL PORT tab

NOTE: If StarFire iTC is hooked into the CAN Bus with an Original GreenStar display and either a GSD2100 or 2600, the StarFire iTC will always be displayed on the GSD2100 or 2600.

NOTE: If an Original StarFire receiver is hooked to a GSD2100 or 2600, the setup and information pages are displayed through Original GreenStar Monitor. MENU >> ORIGINAL GREENSTAR MONITOR. To view or change setup information, SETUP >> STARFIRE RECEIVER. To view GPS information INFO >> STARFIRE RECEIVER.

PC8663 -UN-05AUG05



MENU button

PC8659 -UN-05AUG05



STARFIRE ITC button

PC8680 -UN-05AUG05



STARFIRE ITC softkey

OUC6050,000223B -19-14NOV06-1/1

INFO tab

StarFire iTC - Main

StarFire iTC - Main—Info Tab

- A—Info tab
- B—Setup tab
- C—Activations tab
- D—Serial Port tab

- E—Position Mode
- F—Differential Mode
- G—Latitude
- H—Longitude

- I—Altitude
- J—GPS Course
- K—GPS Speed
- L—Accuracy

- M—GPS Signal
- N—Differential Signal
- O—Roll Angle
- P—Yaw Rate

The INFO tab shows information and status of incoming GPS and differential correction signals. No information on this screen can be changed. It is for viewing only:

- Position Mode: Indicates whether receiver is calculating a 3D position, 2D position, or no position (No Nav). It also shows status of differential signal: SF1 (StarFire 1 differential), SF2 (StarFire 2 differential).
- Differential Mode: Indicates status of GPS signal: 2-D (two dimensional with latitude and longitude of vehicle) or 3-D (three dimensional with altitude, latitude, and longitude of vehicle).
- Lat: Displays vehicle location latitude coordinates with respect to Equator (north or south).
- Lon: Displays vehicle location longitude coordinates with respect to Prim Meridian (east or west).

Continued on next page

OUC6050,000223C -19-14NOV06-1/2

NOTE: TOGGLE button allows operator to change the way latitude and longitude are displayed from degrees/minutes/seconds to decimal degrees.

- Altitude: displays height of receiver, measured from top of dome, in feet (meters) above sea level.
- GPS course: Displays direction of travel, in degrees relative to true north (zero degrees) as measured by receiver. Angle is measured in clockwise direction

NOTE: Course and speed normally show small speeds and various courses even when machine is not moving.

- GPS speed: displays ground speed of machine in miles per hour (kilometer per hour) as measured by receiver.
- GPS Accuracy Indicator (GPS AI): GPS AI gives indication of GPS position accuracy achieved by receiver, and is displayed as a percentage (0-100%)

When receiver is initially powered, GPS AI will display 0%. As receiver acquires satellites and calculates a position, GPS AI will increase as accuracy improves. Acceptable guidance performance for Parallel Tracking and AutoTrac is achieved when GPS AI displays 80% or greater. This may take up to 20 minutes. GPS accuracy is affected by many factors. If 80% accuracy or greater is not achieved within 25 minutes, consider the following possibilities:

- Unobstructed view of sky – trees, buildings, or other structures may block receiver from receiver signals from all available satellites.

- L1/L2 signal to noise ratio (SNR) – radio interference from 2-way radios or other sources may cause low SNR (check satellite button – Graph)
- Satellite position in sky – poor GPS satellite geometry can reduce accuracy (check satellite button – SkyPlot)
- Number of satellites above elevation mask – this is the total number of GPS satellites available to receiver that are above 7 degrees elevation mask (check satellite button – SkyPlot).
- Number of satellites in solution – this is total number of satellites that are being used by receiver to calculate a position (check satellite button– SkyPlot).
- GPS Signal Quality: Displays quality of signals being received from constellation of GPS satellites.
- Differential Signal Quality: Displays quality of differential correction signal being received by receiver.
- TCM (Terrain Compensation Module):
 - Roll Angle: Is both a graphical and numerical representation of amount of roll TCM is measuring, relative to calibrated zero degree reference. A positive roll angle means vehicle is rolled to right (depicts what horizon would look like from cab).
 - Yaw Rate: This gives a graphic representation and a numeric figure for amount of rotation TCM is measuring. Positive yaw rate means vehicle is turning to right.

SETUP tab

StarFire iTC - Main

StarFire iTC - Main—Setup tab

- | | | | |
|-------------------|--------------------------------|---------------------|----------------------------|
| A—Info tab | E—Correction Mode | H—Fore/Aft | K—Hours On After Shutdown |
| B—Setup tab | F—Default Correction Frequency | I—Height | L—TCM On/Off toggle button |
| C—Activations tab | G—Mount Direction | J—Enable QuickStart | M—TCM Calibration button |
| D—Serial Port tab | | | |

The SETUP tab allows for setup of the following:

- Correction Mode
- Correction Frequency
- Mount Direction
- Fore/Aft
- Height
- QuickStart

- Hours ON After Shutdown
- TCM Calibration

Differential correction is the process by which GPS accuracy is improved. (See OVERVIEW: SF1/SF2 Activations, SF2 Subscription under Activations section.)

Correction Mode

Contains available StarFire corrections that the receiver is licensed for. SF1 and OFF will always appear, however, SF2 will only appear with a valid SF2 license (See Activations section). RTK appears when a RTK mode is selected from RTK softkey.

NOTE: By selecting OFF, StarFire receiver will not receive SF1 or SF2 correction signals, but will receive WAAS/EGNOS correction signals.

OUO6050,000223E -19-14NOV06-1/1

Correction Frequency

This is the frequency that is used to receive differential correction signals. The default frequency is a view only field when default check box is checked. By de-selecting default check box a correction frequency can be manually entered.

IMPORTANT: DO NOT change default StarFire Correction Frequency unless instructed to do so by a John Deere Dealer or by John Deere AG Management Solutions.

OUO6050,000223F -19-14NOV06-1/1

Mount Direction

NOTE: Receivers attached to tractors, sprayer, and combines are typically in FORWARD position. Receivers attached to GATORS are typically in BACKWARD position.

Mounting direction options

- FORWARD
- BACKWARD

Mounting direction is direction receiver is facing.

Select desired mounting direction.

This setting defines mounting orientation of receiver. TCM uses this setting to determine correct direction of vehicle roll.

OUO6050,0002240 -19-14NOV06-1/1

Fore/Aft

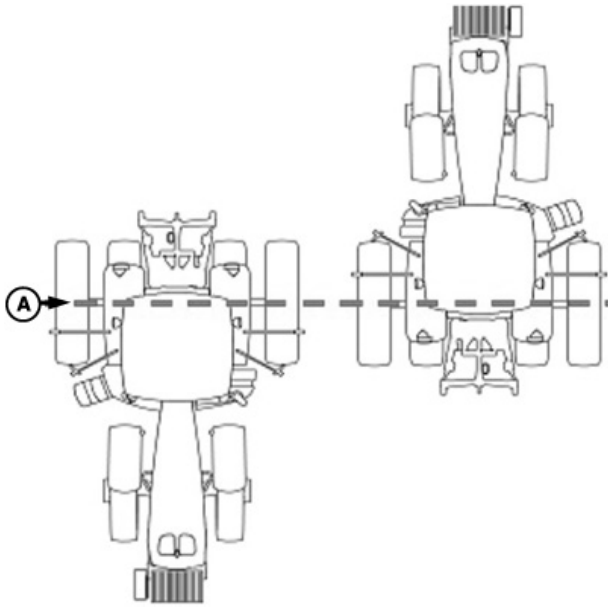

Floating Front Axle Vehicles

PC8278 -UN-22JUN04

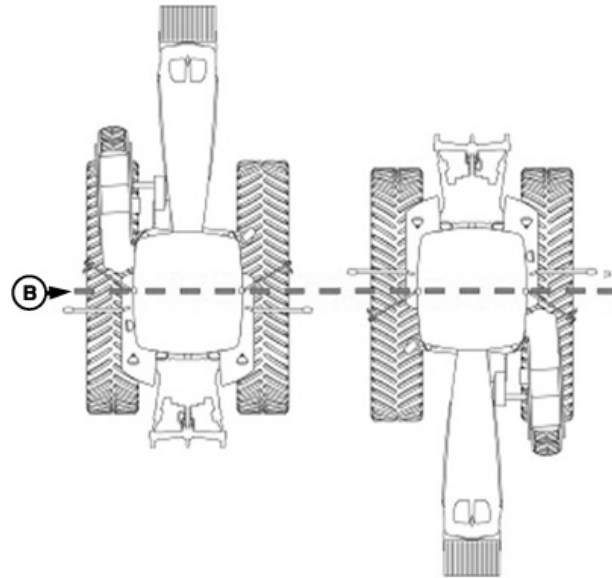

Fixed Axis Wheels or Tracks Vehicles

PC8277 -UN-01MAY06

A—Pivot Point—Floating Front Axle Vehicles-

B—Pivot Point—Fixed Axis Wheels or Tracks Vehicles

The fore/aft value is the distance that receiver is located from pivot point of tractor.

On some AutoTrac-equipped vehicles, fore/aft value will be automatically detected and entered during power up.

- Fore/Aft value is shown and input box is disabled – value has been automatically set and cannot be changed. The value shown may not be the exact distance that the receiver is located from pivot point of tractor, but the best Fore/Aft value for AutoTrac.
- Fore/Aft value is shown and input box is enabled – value must be entered manually.

To enter Fore/Aft value:

- Select FORE/AFT input box

- Enter value using numeric keypad

Recommended StarFire Fore/Aft values For John Deere Vehicles	
John Deere Vehicle	StarFire Fore/Aft cm (in.)
6000 Series Tractors	180 cm (71 in.)
7000 Series Tractors	210 cm (82.5 in.)
8000 Series Tractors	210 cm (82.5 in.)
8000T Series Tractors	51 cm (20 in.)
9000 Series Tractors	-51 cm (-20 in.)
9000T Series Tractors	51 cm (20 in.)
4700 Series Sprayers	280 cm (110 in.)
4900 Series Sprayers	460 cm (181 in.)
Combine	220 cm (87 in.)
Forage Harvester	157 cm (62 in.)

OUO6050,0002241 -19-25NOV06-1/1

Height

Height is measured from ground to top of StarFire Dome. Select input box and use numeric keypad to enter height.

IMPORTANT: Under or over compensation for vehicle roll angles will occur if height is incorrectly entered during setup.

Example: On a 10 degree slope with a StarFire height error of 30.5 cm (12 in.) will result in a position offset of 5 cm (2 in.) on ground).

Factory default setting is “126”. On some AutoTrac-equipped vehicles, height value will be automatically detected and entered during power up. Because this dimension is critical for proper operation of TCM and can vary due to vehicle configuration and tire sizes, operator should still measure actual distance

to be entered each time TCM is installed on a different vehicle.

NOTE: Use chart for example StarFire Height values.

Chart figures are approximate heights.

John Deere Vehicle	StarFire Height cm (in.)
6000 Series Tractors	280 cm (111 in.)
7000 Series Tractors	305 cm (120 in.)
8000 Series Tractors	320 cm (126 in.)
8000T Series Tractors	320 cm (126 in.)
9000 Series Tractors	361 cm (142 in.)
9000T Series Tractors	356 cm (140 in.)
4700 Series Sprayers	389 cm (153 in.)
4900 Series Sprayers	396 cm (156 in.)
Combine	396 cm (156 in.)

NOTE: Actual height may vary depending on tire size or inflation.

OUO6050,0002242 -19-14NOV06-1/1

QuickStart

Reduces amount of time required before full accuracy is achieved. If QuickStart is enabled (check box checked) and receiver has SF1 or SF2 when it is powered down a position is saved for future QuickStart. If power is restored to receiver within time period defined under Hours On After Shutdown, QuickStart won't be needed since receiver power was never disrupted. If duration has exceeded Hours On After Shutdown, QuickStart will be initiated. Saved

position will be used to bypass startup warm up period that is usually required. Receiver cannot move while this QuickStart is taking place. It may take up to 6 minutes for QuickStart to complete. User will be notified on screen when it is done.

To enable QuickStart mode select check box so that a check appears. To disable, select check box until check disappears.

OUO6050,0002243 -19-14NOV06-1/1

Hours On After Shutdown

Defines how long receiver remains powered up after ignition is turned off (0, 3, 6, 12, 24 hours). If ignition is turned on within number of hours defined, receiver will re-establish full SF1 or SF2 accuracy within a few seconds (assuming it had SF1 or SF2 when ignition was turned off).

Define desired number of hours by selecting drop-down box.

OUC6050.0002244 -19-14NOV06-1/1

TCM Calibration

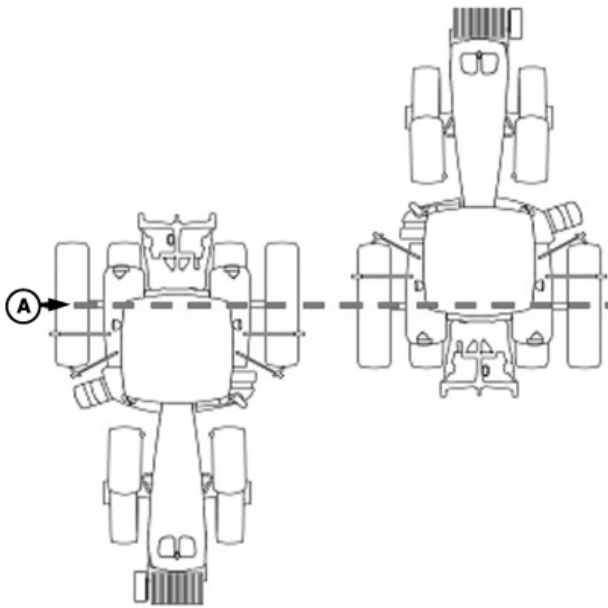

Floating Front Axle Vehicles

A—Rear Axle

PC8278 -UN-22JUN04

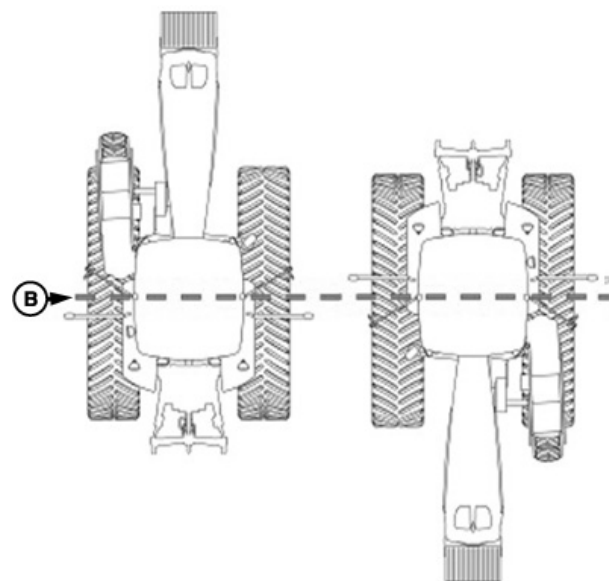

Fixed-Axis Wheels Or Tracks Vehicles

B—Vehicle Pivot Point

PC8277 -UN-01MAY06

TCM can be toggled ON or OFF by selecting TOGGLE button. When TCM is turned off, StarFire GPS message will not be corrected for vehicle dynamics or side slopes. TCM will default to ON when cycling power.

NOTE: TCM must be turned on for AutoTrac to activate.

TCM must be calibrated so receiver can determine zero degree roll angle.

Continued on next page

OUC6050.0002245 -19-14NOV06-1/4

NOTE: Calibrate receiver when it is attached or reattached to machine. Receiver does not require recalibration until removed from machine and reattached.

Positioning Machine during Calibration

IMPORTANT: When calibrating, it is important that TCM is at same angle when facing either direction. If roll angle is a positive 2 degrees when facing one direction, vehicle needs to be a negative 2 degrees when facing opposite direction. To position TCM at same angle it is important when turning vehicle around and facing other direction that tires are placed in correct location. Once vehicle is parked on a hard flat surface, note

location of tires on ground. When turning around use following instructions:

- **Floating Front Axle Vehicles (MFWD, ILS, TLS)—**put rear axle/wheels in same location when performing 2 point calibration. See above diagram for Floating Front Axle Vehicles.
- **Fixed-Axis Wheels Or Tracks Vehicles (Track Tractors, 47X0 and 49X0 Series Sprayers, 9000, And 9020 Series Wheel Tractors)—**Place all in same location when facing either direction. See above diagram for Fixed-Axis Wheels Or Tracks Vehicles.

Continued on next page

OUC6050,0002245 -19-14NOV06-2/4

Calibration Surface

IMPORTANT: Vehicle must be on a hard, flat level surface for calibration. If TCM is not calibrated on a level surface or TCM mounting angle is not level in relation to vehicle angle (StarFire mounting bracket or vehicle cab being slightly offset, uneven tire pressures from one side to other, etc.) operator may see offset during operation. This offset could look like a consistent skip (A) or overlap (B) in pass-to-pass operation. To eliminate offset, re-calibrate on a level surface, drive down a pass, turn around and drive down same pass in opposite direction. If vehicle does not follow same pass, measure offset distance and enter in implement offset. After initial calibration of TCM, it is not necessary to calibrate again unless TCM angle in relation to vehicle has changed. For example, tire pressure has been lowered on one side of vehicle causing vehicle angle in relation to ground to change.

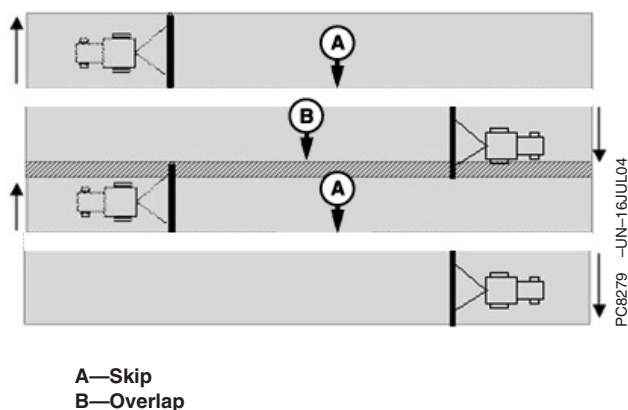

Calibration Procedure:

1. Press CALIBRATION button.
2. Park vehicle on a hard, level surface and come to a complete stop (cab is not rocking).
3. Press ENTER button.
4. Calibrating Status bar will appear. Once status reaches 100% it will automatically advance.
5. Turn vehicle 180 degrees to face opposite direction. Ensure that tires are in proper location for fixed or floating front axle and vehicle has come to a complete stop (cab is not rocking).
6. Press ENTER CALIBRATION button.
7. Calibrating Status bar will appear. Once status reaches 100% it will automatically advance.
8. Once finished, a calibration value will be displayed. 0 degree calibration value is the difference between factory calibration value and actual calibration value which was just determined.

Continued on next page

OUO6050,0002245 -19-14NOV06-3/4

9. Press ENTER button to return to SETUP tab.

OUO6050,0002245 -19-14NOV06-4/4

ACTIVATIONS tab

StarFire iTC - Main



Activations

SF1, SF2 Ready, RTK

Activation Code

SF2 License **Yes-Enabled**

SF2 End Date **10-01-2007**

StarFire SN **328578**

Activation / License Status Window

8:44 am

StarFire iTC - Main—Activations tab

- A—Info tab
- B—Setup tab
- C—Activations tab
- D—Serial Port tab
- E—Activation Code Enter button

ACTIVATIONS tab contains the following:

- Valid activations for receiver:
 - SF1 – activated on every StarFire iTC.
 - SF2 Ready – receiver has to be ordered SF2 Ready or an upgrade to SF2 ready from SF1 World Solution must be purchased.
 - RTK – activated with valid RTK activation (requires receiver to be SF2 Ready).
- SF2 License: Displays status of receiver’s SF2 License.
 - Yes-Enabled – A valid SF2 license exists and SF2 is the differential correction mode selected.
 - Yes-Disabled – A valid SF2 license exists, but SF2 is not the differential correction mode selected.
 - No – Appears when no valid SF2 license exists or SF2 license has expired.
- SF2 End Date: Displays date at which SF2 License will expire.
- StarFire SN: StarFire serial number

Continued on next page

OUO6050,0002246 –19–14NOV06–1/3

Activation Code

NOTE: Activation Codes are needed to obtain SF2 Ready and RTK Activations, and SF2 license subscription.

ENTER button is used to enter 24-digit codes for SF2 Ready and RTK Activations, SF2 license subscription and deactivation codes for transferring all StarFire activations and licenses mentioned above.

1. Upon selecting ENTER button an Activation Code box appears with three input boxes.

NOTE: If more than 8 digits are entered into an input box, "9999999" will appear. Reselect box and type only 8 digits into input box.

2. Select first input box labeled Digits 1-8 and enter first 8 digits of 24-digit code.
3. Select second input box labeled Digits 9-16 and enter second 8 digits of 24-digit code.
4. Select third input box labeled Digits 17-24 and enter last 8 digits of 24 digit code.
5. Press ENTER button.
6. If 24-digit code is valid and entered correctly a confirmation message will appear.

7. Deactivation Code input

This input will only appear when a deactivation code has been entered following procedure listed above. It will display 6-digit deactivation codes for SF2 License, SF2 Ready and RTK activations. These codes are needed when transferring the above mentioned activations or license to another receiver.

Activation/License Status Window

Displays messages when SF2 License has expired and provides user with option to use a Grace Period.

The screenshot shows a screen titled "Activation Code" with the instruction "Enter Activations". There are three input fields for "Digits 1-8", "Digits 9-16", and "Digits 17-24", each containing "00000000". Below the input fields are two buttons: "B" (Cancel) and "A" (Enter). The screen is labeled "Activation Code" at the bottom.

Activation Code

A—Enter button
B—Cancel button

PCS708 -JUN-10NOV06

Continued on next page

OUC6050,0002246 -19-14NOV06-2/3

NOTE: Three 24 hour Grace periods are available when current license expires. This is provided to allow sufficient time for operator to renew a license. Grace period signal will be SF2 differential correction signal.

Using a Grace Period

1. Select USE 1 button from status window
2. Select YES button

OUO6050.0002246 -19-14NOV06-3/3

SERIAL PORT tab

StarFire iTC - Main

StarFire iTC - Main—Serial Port tab

A—Info tab
B—Setup tab

C—Activations tab
D—Serial Port tab

E—Baud Rate
F—Output Rate

G—Messages

Configure RS232 and NMEA message information.

Rates:

- Define Baud Rate by selecting list input
 - Baud Rates: 4800, 9600, 19200, 38400

- Define output rate by toggling
 - 1Hz or 5Hz

Messages:

- Allows for output of 5 different NMEA strings:
 - GGA, GSA, RMC, VTG, and ZDA

NMEA Strings

NMEA String Data – Utilizing a third party GPS receiver or utilizing a StarFire iTC

National Marine Electronics Association (NMEA) has developed a specification that defines the interface between various pieces of electronic equipment.

One of the most important NMEA sentences include the GGA which provides the current Fix data, the RMC which provides the minimum GPS sentences information, and the GSA which provides the Satellite status data.

GGA - essential fix data which provide 3D location and accuracy data.

GGA STRING EXAMPLE:

```
$GPGGA,123519,4807.038,N,01131.000,E,
1,08,0.9,545.4,M,46.9,M,,*47
```

Where:

GGA	Global Positioning System Fix Data
123519	Fix taken at 12:35:19 UTC
4807.038,N	Latitude 48 deg 07.038' N
01131.000,E	Longitude 11 deg 31.000' E
1	Fix quality: 0 = invalid 1 = GPS fix (SPS) 2 = DGPS fix 3 = PPS fix 4 = Real Time Kinematic 5 = Float RTK 6 = estimated (dead reckoning) 7 = Manual input mode 8 = Simulation mode
08	Number of satellites being tracked
0.9	Horizontal dilution of position
545.4,M	Altitude, Meters, above mean sea level
46.9,M	Height of geoid (mean sea level) above WGS84

GSA - GPS DOP and active satellites. This sentence provides details on the nature of the satellite constellation fix. It includes the numbers of the satellites being used in the current solution and the DOP. DOP (dilution of precision) is an indication of the effect of satellite geometry on the accuracy of the fix. It is a unitless number where smaller is better. For 3D fixes using 4 satellites a 1.0 would be considered to be a perfect number, however for overdetermined solutions it is possible to see numbers below 1.0.

There are differences in the way the PRN's are presented which can effect the ability of some programs to display this data. For example, in the example shown below there are 5 satellites in the solution and the null fields are scattered indicating that the almanac would show satellites in the null positions that are not being used as part of this solution. Other receivers might output all of the satellites used at the beginning of the sentence with the null field all stacked up at the end. This difference accounts for some satellite display programs not always being able to display the satellites being tracked. Some units may show all satellites that have ephemeris data without regard to their use as part of the solution but this is non-standard.

GSA String Example

\$GPGSA,A,3,04,05,,09,12,,,24,,,,,2.5,1.3,2.1*39

Where:

GSA	Satellite status
A	Auto selection of 2D or 3D fix (M = manual)
3	3D fix - values include: 1 = no fix 2 = 2D fix 3 = 3D fix
04,05	PRNs of satellites used for fix (space for 12)
2.5	PDOP (dilution of precision)
1.3	Horizontal dilution of precision (HDOP)
2.1	Vertical dilution of precision (VDOP)
*39	the checksum data, always begins with *

RMC - NMEA has its own version of essential gps pvt (position, velocity, time) data. It is called RMC, The Recommended Minimum, which will look similar to:

RMC String Example

\$GPRMC,123519,A,4807.038,N,01131.000,

E,022.4,084.4,230394,003.1,W*6A

Where:

RMC	Recommended Minimum sentence C
123519	Fix taken at 12:35:19 UTC
A	Status A=active or V=Void.
4807.038,N	Latitude 48 deg 07.038' N
01131.000,E	Longitude 11 deg 31.000' E
022.4	Speed over the ground in knots
084.4	Track angle in degrees True
230394	Date - 23rd of March 1994
003.1,W	Magnetic Variation
*6A	The checksum data, always begins with *

VTG - Velocity made good. The gps receiver may use the LC prefix instead of GP if it is emulating Loran output.

VTG String Example

\$GPVTG,054.7,T,034.4,M,005.5,N,010.2,K*33

where:

VTG	Track made good and ground speed
054.7,T	True track made good (degrees)
034.4,M	Magnetic track made good
005.5,N	Ground speed, knots
010.2,K	Ground speed, Kilometers per hour
*33	Checksum

ZDA - Data and Time

ZDA String Example

\$GPZDA,hhmmss.ss,dd,mm,yyyy,xx,yy*CC

\$GPZDA,201530.00,04,07,2002,00,00*6E

where:

hhmmss	HrMinSec(UTC)
dd,mm,yyy	Day,Month,Year
xx	local zone hours -13..13
yy	local zone minutes 0..59
*CC	checksum

OOU6050,0000ED9 -19-07NOV07-4/4

SATELLITE INFORMATION softkey

Press: MENU button >> STARFIRE ITC button >> SATELLITE INFORMATION softkey.

The StarFire iTC - Satellite Information screen contains SKY PLOT and GRAPH tabs.

PC8663 -UN-05AUG05



MENU button

PC8659 -UN-05AUG05



STARFIRE ITC button

PC8682 -UN-05AUG05

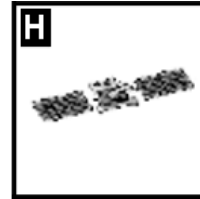

SATELLITE INFORMATION softkey

Continued on next page

OOU6050,0002248 -19-14NOV06-1/4

StarFire iTC - Satellites

A Sky Plot

B Graph

J

K Satellite Tracking

Sat ID	Position Elv	Azm	L1 SNR	L2 SNR	Status
3	46	122	48	40	OK rtk
7	24	52	49	36	OK rtk
13	63	303	52	40	OK rtk
16	46	50	51	39	OK rtk
19	27	152	47	37	OK rtk
20	11	205	45	34	OK rtk
23	73	184	52	44	OK rtk
25	11	96	43	33	OK rtk
27	31	292	47	39	OK rtk
8	5	280	37	21	Low
31	3	94	39	21	Low
w1	NA	NA	45	NA	Lock

C Satellites in Solution 9

F Corrections Age (sec) 1

D Satellites Above Elev Mask 9

G VDOP 1.2

E Satellites Tracked 11

H HDOP 1.2

I PDOP 1.7

8:45am

StarFire iTC - Satellites

- | | | | |
|--------------------------|-----------------------------------|-------------------|--------------------------|
| A—Sky Plot tab | D—Satellites Above Elevation Mask | F—Corrections Age | I—PDOP |
| B—Graph tab | E—Satellites Tracked | G—VDOP | J—Satellites on Sky Plot |
| C—Satellites in Solution | | H—HDOP | K—Satellite Tracking |

SKY PLOT tab

Illustrates where satellites are in relation to vehicles receiver. This allows operator to look at satellite geometry.

Reading Satellite Sky Plot

- Sky Plot is fixed so that North is always at top.
- Satellites are displayed as their satellite ID number that correspond to Satellite Tracking Chart located right of Sky Plot
 - Red – indicates satellite is in search mode
 - Blue – indicates satellite is being tracked

- Green – indicates satellite is OK (being used for corrections)
- Sky Plot consists of 3 concentric rings depicting 0, 30, and 60 degrees of elevation with directional crossbar intersection representing 90 degrees of elevation.
- Grey radial lines extending from center of Sky Plot represent azimuth. They are spaced 30 degrees apart and represent 30 and 60 degrees.
- Directional crossbar representing North, South, East, and West also represent azimuth at 0, 90, 180, and 270 degrees.
- W1 and W2 (WAAS/EGNOS) satellites and inmarsat satellites are not shown in Sky Plot.

Continued on next page

OOU6050,0002248 –19-14NOV06-2/4

Satellite Tracking Chart

- SAT ID – (Satellite Identification Number) Identification number for GPS Satellite.
- ELV – (Position Elevation) Elevation in degrees above horizon for GPS satellite position
- AZM – (Position Azimuth) Azimuth in degrees from true North for GPS satellite
- L1 SNR – (L1 Signal to Noise Ratio) Signal strength for L1 GPS signal (signal to noise ratio)
- L2 SNR – (L2 Signal to Noise Ratio) Signal strength for L2 GPS signal (signal to noise ratio)
- Status – (GPS Signal Status) Status of GPS signal
 - Search – searching for satellite signal
 - Track – tracking satellite signal and using it for positioning
 - OK – tracking satellite signal and using it for positioning
 - OK SF1 – Tracking satellite signal and using it for positioning with STARFIRE single frequency
 - OK SF2 – Tracking satellite signal and using it for positioning with STARFIRE dual frequency

Satellite Tracking Information

Satellite Tracking information is displayed at bottom of SKY PLOT and GRAPH tabs.

- Satellites in Solution – number of satellites used to compute position.
- Satellites Above Elevation Mask – total number of GPS satellites available to receiver that are above 7 degree elevation mask.
- Satellites Tracked – total number of GPS satellites tracked by receiver.
- Corrections Age (sec) – age of differential correction signal to GPS (normally less than 10 seconds)
- VDOP – Vertical Dilution of Precision
- HDOP – Horizontal Dilution of Precision
- PDOP – Positional Dilution of Precision is an indicator of GPS satellite geometry as viewed by receiver. A lower PDOP indicates better satellite geometry for calculating both horizontal and vertical position.

Continued on next page

OOU6050,0002248 -19-14NOV06-3/4

StarFire iTC - Satellites

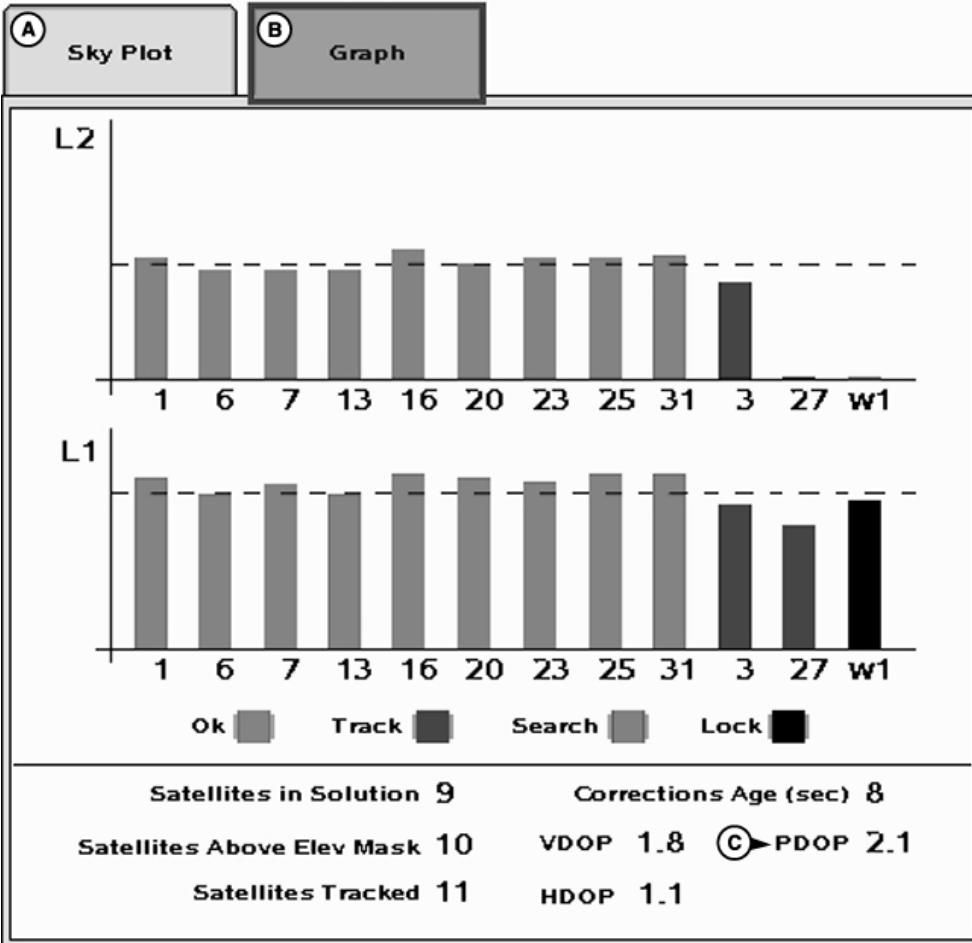

StarFire iTC - Satellites

A—SkyPlot

B—Graph

C—PDOP

Graph

A graph illustrating L1 and L2 SNR values.

- Bars are colored to satellites current status.
- SNR values (colored bar) should be above dashed line that runs horizontally across bar graph.

NOTE: ONLY GREEN bars are used in calculation of PDOP, VDOP, AND HDOP. SNR's are considered good if above dashed line.

Satellite Predictor

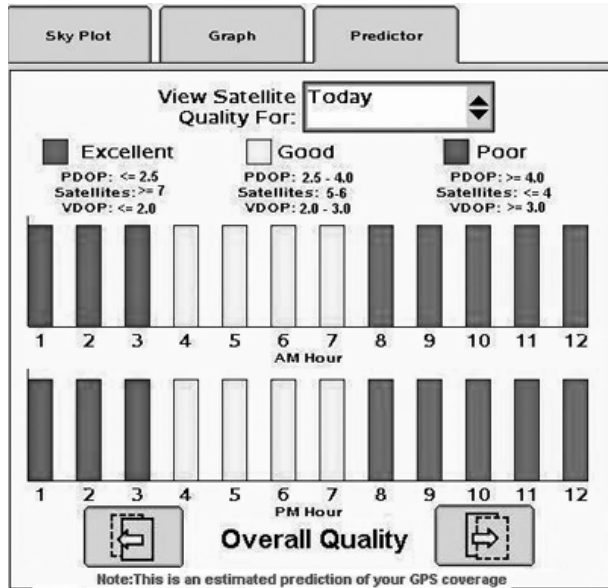

Quality

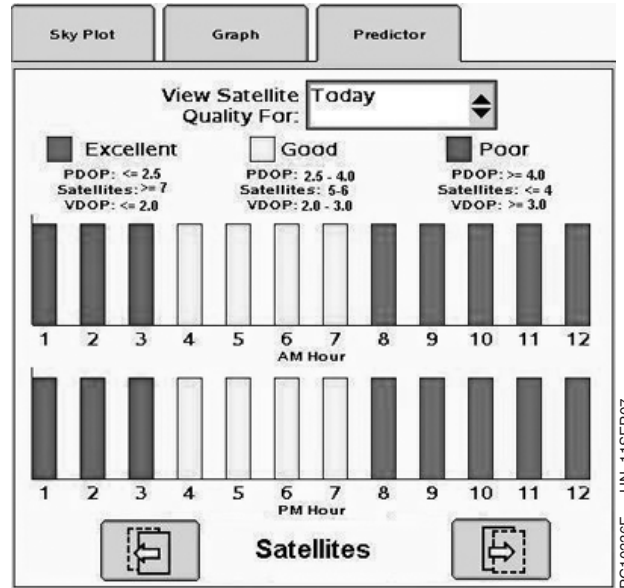

Sats

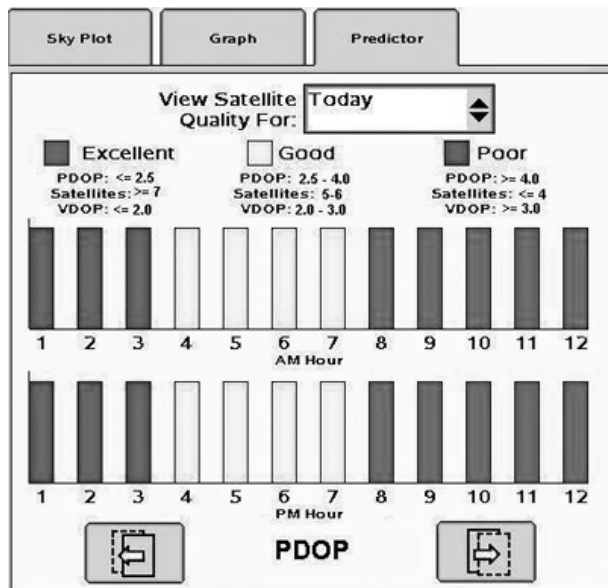

PDOP

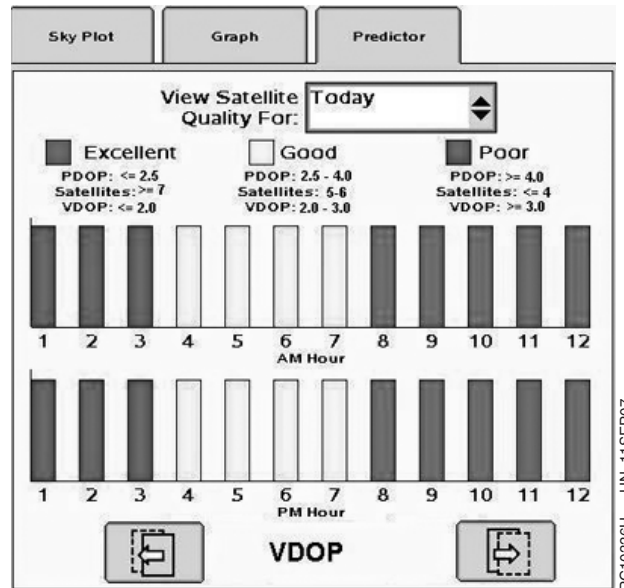

VDOP

NOTE: This is an estimated prediction of your GPS coverage

Satellite PREDICTOR will enable operator to plan out the day based upon the prediction of GPS accuracy. This only applies to the Color GS2 display.

Satellite PREDICTOR shows a prediction of GPS accuracy. for one day in the past, the current day, and one day in the future. The current location will be used for the prediction.

Continued on next page

OUC6050,0000DAE -19-18OCT07-1/2

Satellite PREDICTOR uses three colors to represent levels of GPS accuracy.

- Green = PDOP < =2.5 and VDOP < =2.0 with 7 or more satellites

- Yellow = PDOP between 2.5 and 4.0 and VDOP between 2.0 and 3.0 with 5 to 6 satellites
- Red = PDOP > =4.0 and VDOP > =3.0 or number of satellites is < 4

OOU6050,0000DAE -19-18OCT07-2/2

DIAGNOSTIC softkey

The StarFire iTC - Diagnostic screen contains three tabs:

READINGS tab

DATA LOGS tab

READINGS tab has detailed information about receiver.

- Unswitched voltage
- Switched voltage
- CAN High voltage (Vehicle Bus)
- CAN Low voltage (Vehicle Bus)
- Software Part Number
- Software Version Number
- Hardware Part Number
- Hardware Serial Number
- Receiver Hours (h)

The following reading will only appear when receiver has a RTK activation.

- RTK Software Number (RTK Radio Software Version)
- RTK Serial Number (RTK Radio Serial Number)
- RTK Status
- RTK Search Time (sec)
- RTK Satellites in Search (above 10 degrees elevation)

DATA LOGS tab has graphed GPS data, logged over the previous 60 minutes.

PC8663 -UN-05AUG05



MENU button

PC8659 -UN-05AUG05



STARFIRE ITC button

PC8683 -UN-05AUG05



DIAGNOSTIC softkey

OOU6050,0002249 -19-14NOV06-1/1



READINGS tab

StarFire iTC - Diagnostics

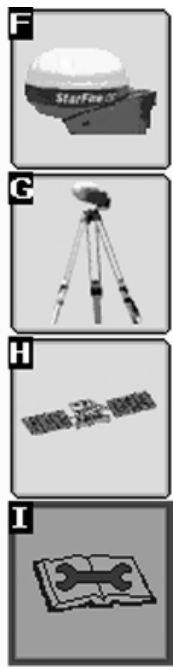
(A) Readings	(B) Data Logs	(C) Radio Self Test
(D) → Unswitched Voltage		13.06
(E) → Switched Voltage		13.32
(F) → CAN High Voltage		2.26
(G) → CAN Low Voltage		2.26
(H) → Software Part Number		PF373260F
(I) → Software Version Number		2.60F
(J) → Hardware Part Number		PF80860
(K) → Hardware Serial Number		328578
(L) → Receiver Hours (h)		799.4
(M) → RTK Software Version Number	2.32C 10-04-2006	
(N) → RTK Serial Number	PCSR09A233682	
(O) → RTK Status	Complete	
(P) → RTK Search Time (sec)	1	
(Q) → RTK Satellites in Search (above 10° elevation)	7	



8:45am

StarFire iTC - Diagnostics

- | | | | |
|--|---------------------------|-------------------------------|----------------------------|
| A—Readings tab | E—Switched Voltage | J—Hardware Part Number | N—RTK Serial Number |
| B—Data Logs tab | F—CAN High Voltage | K—Hardware Serial Number | O—RTK Status |
| C—Radio Self Test tab (North America Only) | G—CAN Low Voltage | L—Receiver Hours | P—RTK Search Time |
| D—Unswitched Voltage | H—Software Part Number | M—RTK Software Version Number | Q—RTK Satellites in Search |
| | I—Software Version Number | | |

DATA LOGS tab

StarFire iTC - Diagnostics

- A Readings
- B Data Logs
- C Radio Self Test

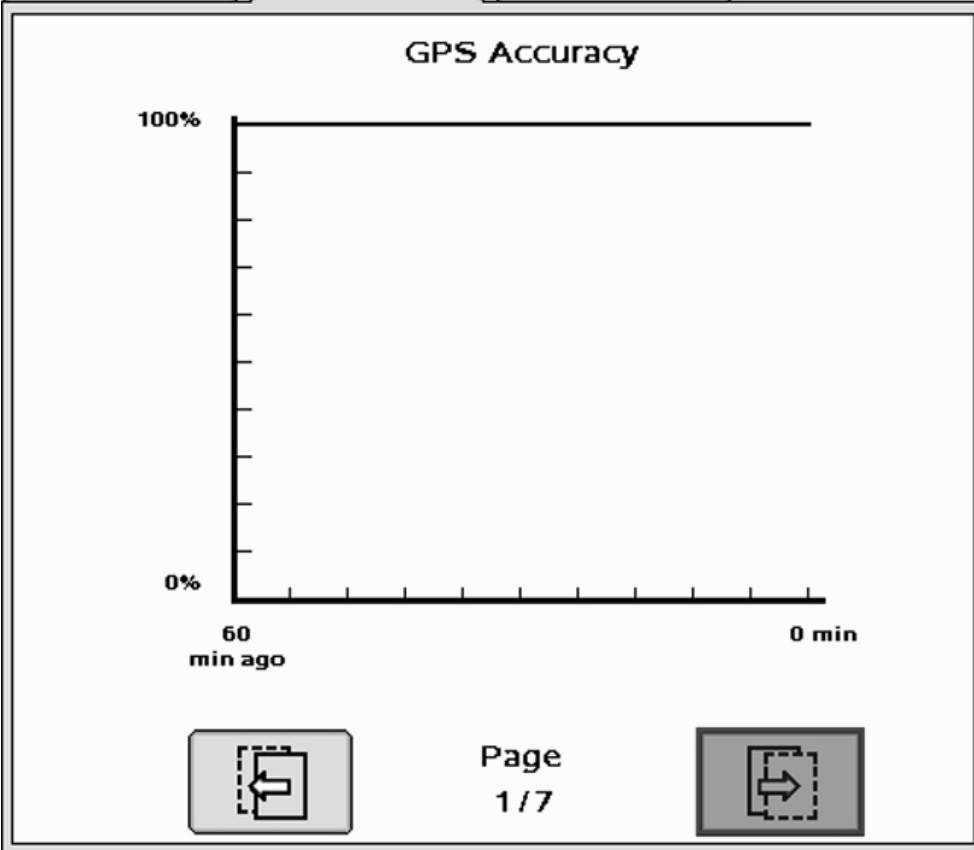

8:46am

StarFire iTC - Diagnostic

A—Readings tab

B—Data Logs tab

C—Radio Self Test tab

GPS Accuracy is a relative indication of overall differential GPS performance

Continued on next page

OUO6050,0000C1D -19-23SEP07-1/7

PC3568 -LIN-09NOV06

StarFire iTC - Diagnostics

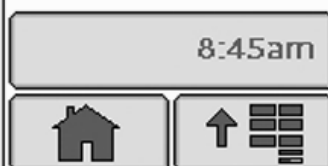
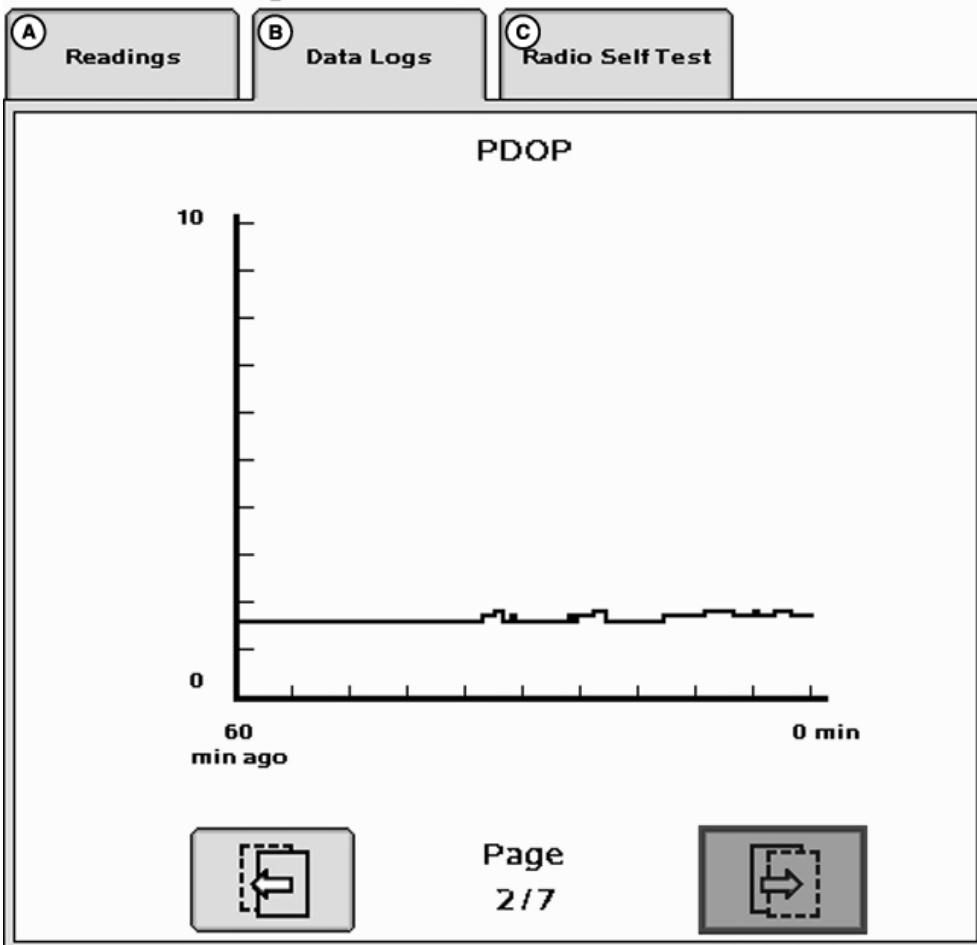

StarFire iTC - Diagnostic

A—Readings tab

B—Data Logs tab

C—Radio Self Test tab

PDOP (Position Dilution of Precision) is a combination of vertical and horizontal error (or three dimensional).

Lower PDOP is better. A value below 2 is considered optimal.

Continued on next page

OOU6050,0000C1D -19-23SEP07-2/7

StarFire iTC - Diagnostics

- A Readings
- B Data Logs
- C Radio Self Test

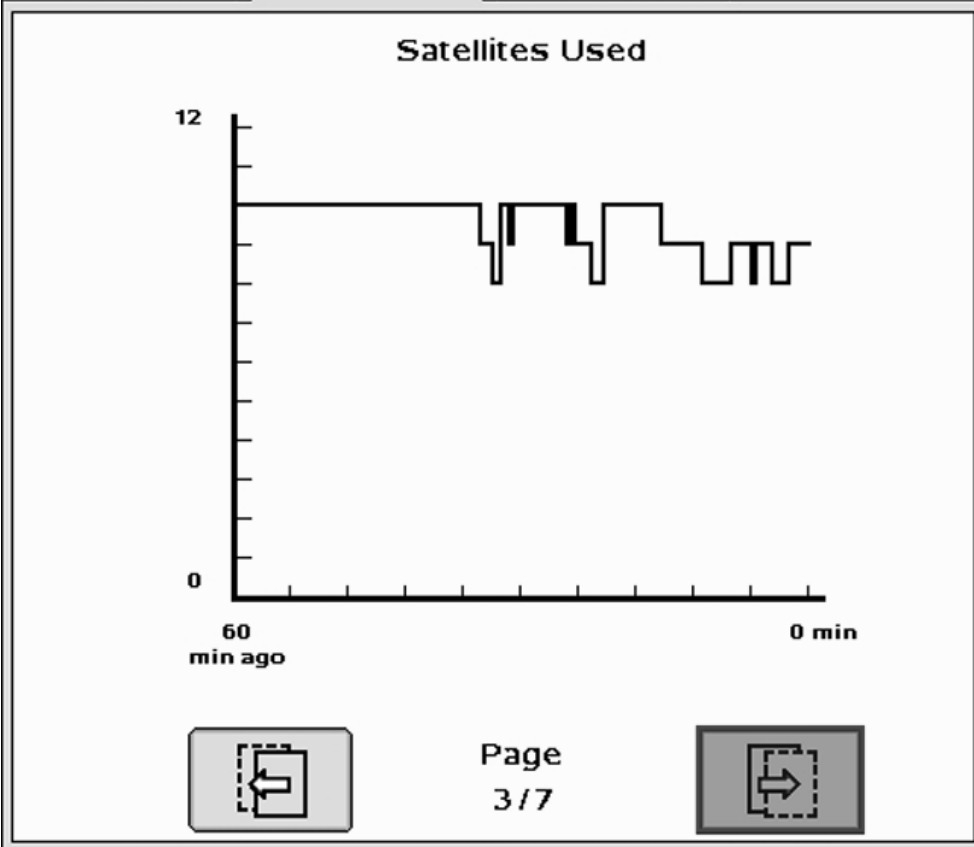

8:45am

StarFire iTC - Diagnostic

A—Readings tab

B—Data Logs tab

C—Radio Self Test tab

Satellites in Solution is the number of satellites that receiver is using in current position solution. Satellites are not used in solution until they get above 7 degrees elevation mask for EGNOS, SF1, or SF2 (10 degrees

for RTK), and satellites are used until they drop below 7 degrees elevation mask for EGNOS, SF1, SF2 or RTK.

Continued on next page

OUO6050,0000C1D -19-23SEP07-3/7

StarFire iTC - Diagnostics

A Readings

B Data Logs

C Radio Self Test

GPS Signal Quality

Page
4 / 7



8:45am

StarFire iTC - Diagnostic

A—Readings tab

B—Data Logs tab

C—Radio Self Test tab

GPS Signal Quality shows quality of signals being received from GPS satellites. Unlike GPS Accuracy

Indicator, Signal Quality doesn't include EGNOS, SF1, SF2 or amount of time signal is received.

Continued on next page

OOU6050,0000C1D -19-23SEP07-4/7

StarFire iTC - Diagnostics

A
Readings

B
Data Logs

C
Radio Self Test

Diff Signal Quality

Page
5/7

F

G

H

I

8:46am

StarFire iTC - Diagnostic

A—Readings tab

B—Data Logs tab

C—Radio Self Test tab

Differential Signal Quality is the strength of StarFire network signal (SF2 or SF1). Normal range is from 5 to 15, but maximum reading on indicator is 10.

Numerical value is displayed to right of indicator. Any value above 5 is normal.

Continued on next page OUO6050,0000C1D -19-23SEP07-5/7

PC8592 -LIN-08NOV06

StarFire iTC - Diagnostics

StarFire iTC - Diagnostic

A—Readings tab

B—Data Logs tab

C—Radio Self Test tab

Navigation Mode is represented as three different types; No Nav, 2D and 3D. This helps determine if GPS position has been dropped in last 60 minutes.

Continued on next page

OOU6050,0000C1D -19-23SEP07-6/7

PC9593 -UN-09NOV06

StarFire iTC - Diagnostics

- (A) Readings
- (B) Data Logs
- (C) Radio Self Test

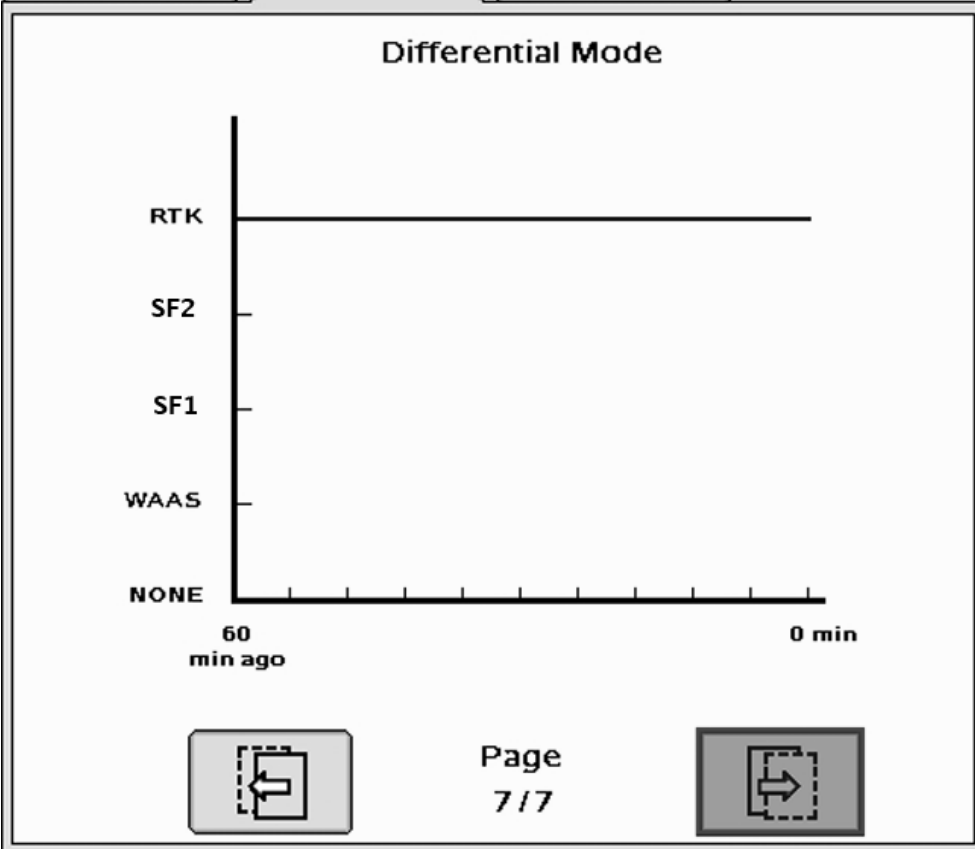
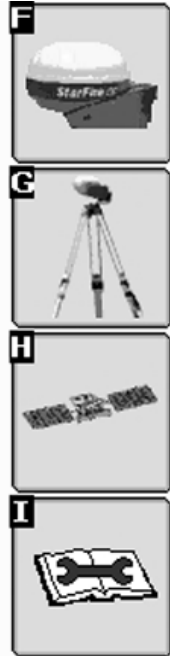

8:46am

🏠

↑

PC9594 - JUN-17-OCT07

StarFire iTC - Diagnostic

A—Readings tab

B—Data Logs tab

C—Radio Self Test tab

Differential Mode shows the level of differential signal that receiver has received over past 60 minutes. Level

of signal that was purchased on receiver will determine highest point on bar graph that operator will see.

OOU6050,0000C1D -19-23SEP07-7/7





Radio Self Test

StarFire iTC - Diagnostics

Radio Self Test

Start

(A)	Number of updates	5
(B)	Frequency(MHz)	869,4125
(C)	Serial Number	63342645
(D)	Part Number	JD3AS869
(E)	Software Version	3.21
(F)	Time Slot	1
(G)	Repeater Mode	OFF
(H)	NetWorkID	4006
(I)	Output Power(mW)	0
(J)	Signal level strength	0
(K)	Data Received	0



10:12

PC10386 -UN-06NOV07

StarFire iTC - Diagnostics

EU Radio Self Test Page STRING SHOWN - DESCRIPTION

- (A) **Number of updates** - Number of test cycles that the Self Test page has performed. During each cycle the test parameters are requested and updated from the radio.
- (B) **Frequency** - Radio Frequency (MHz)
- (C) **Serial Number** - Radio Serial Number
- (D) **Part Number** - Part number that identifies an RTK radio type: "JD3AS869" is a 869 MHz radio with 0.5 Watt power
- (E) **Software Version** - Radio Software Version
- (F) **Time Slot** - Radio Time Slot
- (G) **Repeater Mode** - ON indicates an RTK Vehicle operated in Vehicle Repeater Mode. OFF indicates an RTK vehicle operated in Vehicle Mode or a Base Station
- (H) **Network ID** - Network Identification (ID) for a system of RTK radios. The Network ID permits communication between a Base Station, Vehicle receivers and potential repeaters.

Radio Self Test in Progress

Radio Self Test in progress...
System is no longer in RTK mode.
Press END button to stop test.

(A)	Number of updates	2
(B)	Frequency(MHz)	869,4125
(C)	Serial Number	63342645
(D)	Part Number	JD3AS869
(E)	Software Version	3.21
(F)	Time Slot	1
(G)	Repeater Mode	OFF
(H)	NetWorkID	4006
(I)	Output Power(mW)	0
(J)	Signal level strength	0
(K)	Data Received	0

End

Radio Self Test

PC10387 -UN-06NOV07

Continued on next page

OJU06050,0000ED8 -19-06NOV07-1/2

- (I) **Output Power** - Radio Output Power (mW)
- (J) **Signal level strength** - Strength Level of signal detected by the radio. The signal level will range from 0 to 100 (-118 dBm to -55 dBm. Values greater than -55 dBm are reported as 100.).
- (K) **Data Received** - Percent of correction messages recognized by the vehicle from the base station or repeater.

OUC6050,0000ED8 -19-06NOV07-2/2

StarFire Signal Monitoring System

The GS2 alerts the operator when the current StarFire signal is not optimal for high accuracy operations. There are three levels of this warning system (Normal, Marginal, and Poor). The levels are determined both by the StarFire Receiver's PDOP value and the number of satellites being tracked. It is recommend that if the StarFire receiver is being used in high accuracy operations that care be taken when the StarFire Signal Monitoring system indicates that the current status is Marginal or Poor, as accuracy degradation may occur.

OUC6050,0000C1E -19-17OCT07-1/4

NOTE: Operating in RTK or RTK-X, both PDOP and "Number of Satellites" are used to determine the level of warning.

Operating at a signal level less than RTK (SF2, SF1, EGNOS, ect.) only PDOP will be used to determine the level of warning.

Normal

- Green Bar
- Normal Operating Range
- Acceptable range for high accuracy operations
- PDOP value: 0 - 3.5
- 6 or more satellites in solution

PC9387 -UN-17OCT06



Normal

Continued on next page

OUC6050,0000C1E -19-17OCT07-2/4

PC9388 -UN-17OCT07

Marginal

- Orange Bar with Permanent Caution Sign
- Marginal Operating Range
- Moderate risk of accuracy degradation - caution is advised
- PDOP value: 3.5 - 4.5
- 5 satellites in solution

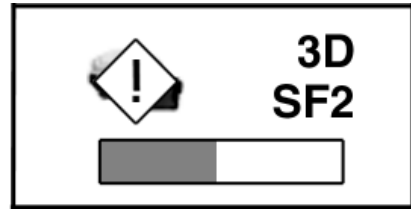

Marginal

OOU6050,0000C1E -19-17OCT07-3/4

PC10384 -UN-17OCT07

Poor

- Red Bar and Flashing Caution Sign
- Poor Operating Range
- Significant risk of accuracy degradation - high accuracy operations are not advised
- PDOP value greater than 4.6
- 4 satellites or less in solution

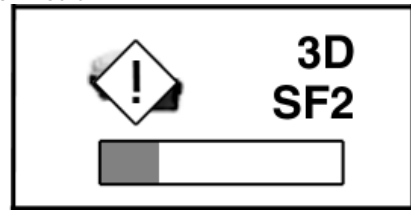

Poor

OOU6050,0000C1E -19-17OCT07-4/4

GS2 Display—RTK

RTK softkey

Allows for setup and display of RTK information

- Operating Mode
- RTK Network Configuration
- Base Station Data
- Radio Data

RTK can be operated in five modes

- Vehicle
- Vehicle Repeater
- Quick Survey Base
- Absolute Base
- OFF

IMPORTANT: Anytime the radio is reconfigured or changed, power must be cycled at the GPS receiver before continuing.

Vehicle Mode Select for receiver on vehicle.

Vehicle Repeater Mode Allows for the vehicle to accept and repeat RTK corrections.

Quick Survey Base Mode Select if exact location of guidance tracks do not need to be stored for future applications. If Quick Survey Base Mode is used to establish rows or paths that will be used at a later date, location or Track 0 must be stored using Current Track 0 in Guidance Setup – Set Track 0. When Track 0 is recalled, a one-time use of Shift Track feature will be needed to align vehicle on previous tracks. See Setup Quick Survey Base Mode section.

PC8663 –UN–05AUG05



MENU button

PC8659 –UN–05AUG05



STARFIRE ITC button

PC8681 –UN–05AUG05



RTK softkey

Continued on next page

OJ06050,0000C1F –19–18OCT07–1/2

Absolute Survey Base Mode Select if exact location of guidance tracks need to be stored for future guidance applications without relying on visual reference for track position to align using Shift Track feature. Track 0 must be stored using Current Track 0 in Guidance Setup – Set Track 0 in order to follow previously used tracks. Absolute Base Mode requires 24-hour self survey to be conducted on location before first use. After survey is completed, base station will then transmit corrections. If base station is moved to another position and then returned to original surveyed position, it is very important that base station is mounted in exact same position. Any difference between original surveyed position and mounted position will result in offset of corrected position. For this reason, it is important to mount receiver to a fixed position like a building or post mounted in concrete.

OFF Mode This mode disables all RTK functionality in receiver. RTK Operating Mode must be OFF for normal SF1 or SF2 operation on SF2-licensed receiver.

Vehicle

StarFire iTC - RTK

Operating Mode

Vehicle A

RTK Network Configuration

B **Radio Channel**
1 - 14 3

C **Network ID**
1 - 4000 760

D **Radio/ Repeater**
Configure

Base Station Data

Status E OK

Sat. Corrections F 9

Location # G Absolute 2

Distance (mi) H 0.00

Direction (°) I 116

Base Battery (V) J 13.1

K **Radio Data**

L **Data received (%)** 100

M **Noise Level** 35

N

Radio Connection O

Base Repeater P

Q



8:45am



StarFire - RTK

A—Operating Mode Vehicle
B—Radio Channel

C—Network ID

D—Radio/Repeater

E—Status

IMPORTANT: Base station receiver and vehicle receiver must be setup before operating RTK. See RTK Setup sections.

When vehicle receiver is powered-up, No GPS, No Diff will be displayed on Guidance View or home page screen until an initial position is determined. When base station transmits correction signal, 3D RTK will be displayed.

NOTE: Check that base station, vehicle, and repeater have same Frequency, Network ID and Time Slot.

Press: MENU button >> STARFIRE iTC button >> RTK softkey >> OPERATING MODE drop down box >> VEHICLE

Continued on next page

OUO6050,0000C20 -19-17OCT07-1/2

NOTE: If communication loss is *WITHIN* first hour of base station operation, *Extend Mode* will provide RTK accuracy for two minutes.

Communication loss *AFTER* first hour of base station operation, *Extend Mode* will provide RTK accuracy for 15 minutes.

Extend Mode (RTK-X)

If communication between base station and vehicle radio is lost for more than 10 seconds, vehicle receiver will automatically switch to Extend Mode and will maintain RTK accuracy for a period of time. If base station has been powered for less than one hour, Extend Mode will be available for 2 minutes. If base station receiver has been powered for more than one hour, 15 minutes of Extend Mode will be available. If base station communication is not re-established after Extend period, receiver will default to EGNOS, or NO DIFF where EGNOS is not available. To re-establish communication move vehicle to a location where line of sight to base station can be established.

Base Station Data (Information)

NOTE: Information that will be displayed when in *Quick Survey Base* or *Absolute Base Mode*.

Operator can view the following:

- Status
 - OK – Base Station is transmitting correction.
 - No Stored Base – 24 hour self survey is required for current location.
 - Initializing – Receiver is initializing radio, acquiring GPS signal.
 - Self Survey – 24 hour self survey in progress.
- Sat. Corrections – Indicates number of GPS satellites for which base station is transmitting correction.
- Distance – Difference between base station location (known position) and location indicated by uncorrected GPS. Displayed in miles (kilometers).

- Direction – Direction from base station location (known position) to location indicated by uncorrected GPS. Displayed in degrees with true North as 0 degrees.
- Base Battery – Base Station voltage. Displayed in volts.

Vehicle Mode – Base Station Data

NOTE: Information that will be displayed when in *Vehicle Mode*.

- Status
 - OK – Base Station is transmitting correction.
 - No Stored Base – 24 hour self survey is required for current location.
 - Initializing – Receiver is initializing radio, acquiring GPS signal.
 - Self Survey – 24 hour self survey in progress.
 - No Signal – Vehicle RTK radio is not receiving signal from base station.
- Sat. Corrections – Indicates number of GPS satellites for which base station is transmitting correction.
- Distance – Difference from base station to vehicle receiver. Displayed in miles (kilometers).
- Direction – Direction in degrees to base station. Displayed in degrees with true North as 0 degrees.
- Base Battery – Base Station voltage. Displayed in volts.

Radio Data and Connection

- Signal Level – Level of signal which is detected at radio. Press Refresh button to refresh signal level.
- Data Received (%) – Percent of received correction to vehicle from base station.

Indicates source of correction. If there is no correction, this will toggle between base and repeater. There is also a TOGGLE button for manual toggle between two sources.

Vehicle Repeater

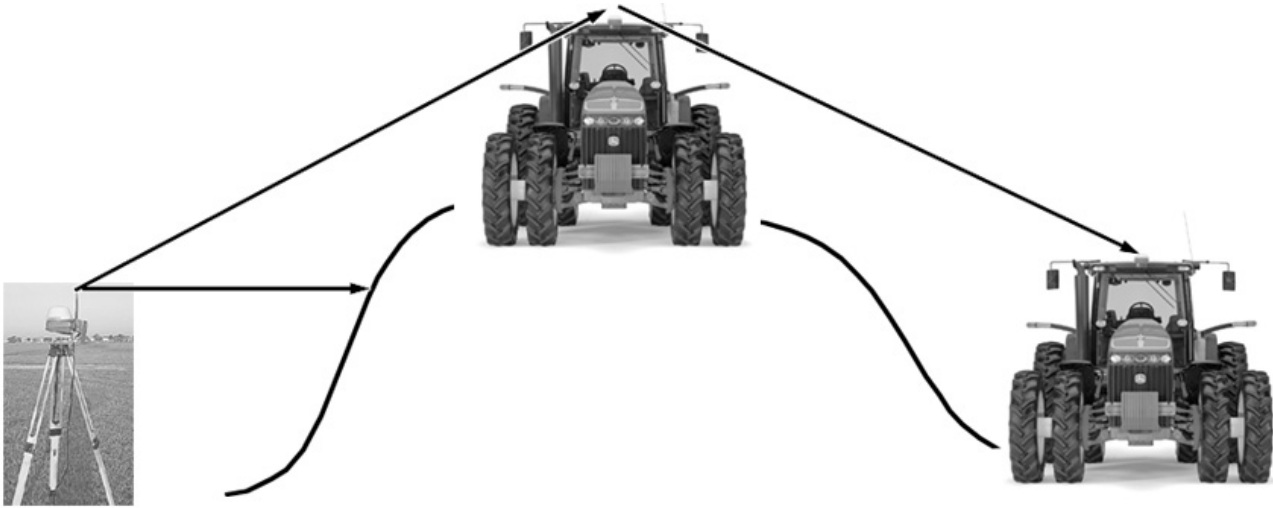

PC9148 - UN-20APE06

Press: MENU button >> StarFire iTC button >> RTK Softkey

Select "Vehicle Repeater" from Operating Mode list box.

In this mode the RTK vehicle radio not only receives messages but also rebroadcasts them (similar to a RTK repeater) to other RTK vehicles in close proximity.

NOTE: Vehicle Repeater is identical to the Vehicle mode with the addition of having the radio rebroadcast the RTK messages.

The Vehicle Repeater mode allows an RTK vehicle to function normally as an RTK vehicle while also

transmitting the base correction signal to another RTK vehicle that does not have line-of-sight to the base station.

The 'Vehicle Repeater' needs to be between the base station and the 'Vehicle'. The 'Vehicle Repeater' must be able to communicate with the base station. The 'Vehicle' must then have either line of sight communication to the base station or 'Vehicle Repeater'.

IMPORTANT: There should be only ONE Vehicle Repeater or Repeater in the same vicinity with the same Network ID. Therefore, a repeater cannot be used in a "daisy chain," repeating the signal from one repeater to another.

OOU6050,0000DAC -19-23SEP07-1/1

Quick Survey Mode

NOTE: Display is not required after base station receiver has been configured to operate in Quick Survey Mode and RTK Radio Frequency, Network ID and Time Slot have been set.

Connect display to base station

Press: MENU button >> STARFIRE ITC button >> RTK softkey

Select Quick Survey Base from Operating Mode list box.

NOTE: Quick Survey Base Mode allows base station to broadcast corrections after receiver calculates GPS position.

If power is removed from base station (but not moved) power can be restored and same base station position will be used for corrections. If previously used Track 0 is recalled, Shift Track may not be needed.

If power is removed and base station is moved a new position will be calculated when power is restored. If previously used Track 0 is recalled, Shift Track will have to be used to center Track 0 on previous vehicle track.

OOU6050,0002251 -19-19NOV06-1/1

Absolute Base Mode

IMPORTANT: Absolute Base Mode requires base receiver to be mounted in a rigid position. Tripod is not recommended.

NOTE: Display is not required after base station receiver has been configured to operate in Absolute Survey Base Mode and RTK Radio Frequency, Network ID and Time Slot have been set.

Connect Display to Base Station

Press: MENU >> STARFIRE ITC button >> RTK softkey

Select Absolute Base from Operating Mode drop-down box.

A 24-hour survey has to be performed and saved to a RTK Base Location (1-200). See Edit Stored Base Station Section.

Continued on next page

OOU6050,0000C23 -19-18OCT07-1/3

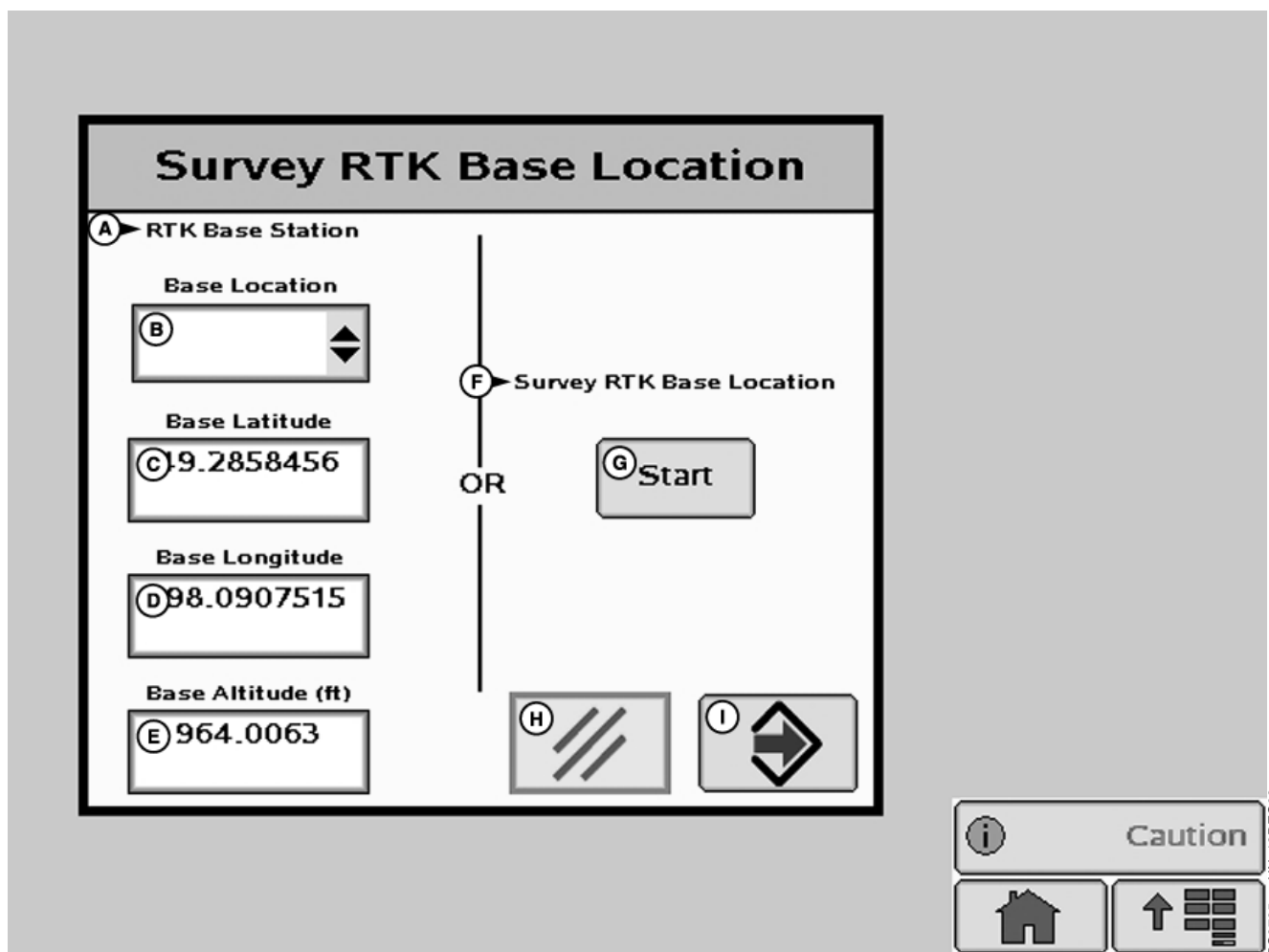

Survey RTK Base Location

A—RTK Base Station
B—Base Location
C—Base Latitude

D—Base Longitude
E—Base Altitude

F—Survey RTK Base Location
G—Start

H—Cancel
I—Enter

NOTE: Enter unique location number each time base station is moved to new mounting location (i.e. location 1 = West 40, location 2 = Farm Shop).
Edit Stored RTK Base: Allows operator to setup Absolute Base Station Locations and conduct 24-hour survey or enter in known location coordinates. **Unknown Coordinates:** Press START button located under Edit Stored RTK Base.

After (24 hour) self survey is complete, base station coordinates will automatically be stored and associated with base location number (1 -

20). Verify base station coordinates, Press START button located under Edit Stored RTK Base while in Absolute Base operating mode and choose base location from base location drop-down box.

Start 24 hour Self Survey

1. Press START button located under Survey RTK Base Location.
2. Select Storage location from drop-down box (1 - 20)
3. Press START button (Starts 24 hour survey)

NOTE: Display can be removed while survey is in progress.

After 24 hour survey is complete, base station will automatically store surveyed coordinates and begin transmitting corrections.

IMPORTANT: Manually record coordinates and elevation and store in safe location. These coordinates may be used to enter previously surveyed base station location into different receiver.

NOTE: Absolute Base Mode, coordinates may be manually entered, if known from previous survey. See Known Location section below.

Known Location

Press START button located under Edit Stored RTK Base.

1. Select desired Base Location from drop-down box (1-20)
2. Select Base Latitude – enter value (deg)
3. Select Base Longitude – enter value (deg)
4. Select Base Altitude – enter value (ft)
5. Press ENTER button

RTK Network Configuration

IMPORTANT: Anytime the radio is reconfigured or changed, power must be cycled at the GPS receiver before continuing.

Time Slot - RTK

NOTE: 10 Time Slots are available. The default time slot is 1.

Check that base station, vehicle, and repeater have same Frequency, Network ID and Time Slot.

Press input box and enter value (1 - 10)

The time slot may be changed if other RTK systems are operating in area interference is causing decreased base station communication performance.

Network ID – RTK

NOTE: 4001 network ID's are available, default ID is 1.

Check that base station, vehicle, and repeater have same Frequency, Network ID and Time Slot.

Press input box and enter value (1 - 4000)

Network ID for base station and vehicle receiver must match. If more than one base station with same Network ID numbers are within range, vehicle may lock on to either one of the base stations. To prevent this from happening, be sure to use unique network ID.

Repeater – RTK

NOTE: Radio can be configured to act separately as repeater. A repeater is required if obstructions (i.e. trees, hills, etc) exist between base station and vehicle(s).

A repeater consists of

- Radio (configured as a repeater)
- Harness
- Mounting Bracket
- 12 volt Power Source

To configure radio as repeater:

Press: MENU button >> STARFIRE ITC button >> RTK softkey

Select RTK Operating Mode (Vehicle, Quick Survey Base or Absolute Base)

NOTE: A radio can be configured as a repeater from any RTK Operating Mode.

1. Disconnect original radio from receiver
2. Connect radio to be configured to receiver RTK harness.
3. Check that the radio serial number and software version are displayed.
4. Check that base station, vehicle, and repeater have same Frequency, Network ID and Time Slot.
5. Press START button located under Configure Repeater Radio
6. Radio will configure as repeater
7. Disconnect repeater radio from receiver and wiring harness
8. Reconnect original radio

OUC6050,0000C24 -19-18OCT07-2/2

Shared Base Station RTK Security

Shared Base Station (SBS) RTK Security is security from unwanted users accessing a SBS RTK Network. This security feature keeps unauthorized RTK vehicles from accessing RTK corrections from the base station by granting access to only those RTK vehicles on an access list.

Compatibility

Base Station This security feature will only be available on StarFire iTC base stations. It will not work on original StarFire receivers being used as base stations.

RTK Vehicle It is compatible with original StarFire and StarFire iTC receivers being used as RTK vehicles.

Locating RTK Vehicle StarFire iTC Serial Number
Software Versions Original StarFire Receiver –

requires software version of 7.50x or greater. StarFire iTC Receiver – requires software version of 2.50x or greater.

Theory of Operation

The SBS RTK Network operator will enter into the base station the serial numbers of RTK vehicle receivers that are allowed to access the RTK corrections from that base station. RTK vehicle serial numbers can be added and removed at any time with an original GreenStar Display. Only those rover serial numbers that are on the access list on the base station receiver will be allowed to access the RTK corrections from the base station.

OUC06050.0002254 –19–25NOV06–1/1

Shared Base Station Security—Setup

StarFire iTC - Shared Base Station Security

(A) RAL Setup

(B) Rover Access List

1: 300071	26:	51:	76:
2: 300058	27:	52:	77:
3: 300020	28:	53:	78:
4: 300065	29:	54:	79:
5: 300036	30:	55:	80:
6: 300095	31:	56:	81:
7: 300052	32:	57:	82:
8: 300041	33:	58:	83:
9: 300046	34:	59:	84:
10: 300016	35:	60:	85:
11: 300091	36:	61:	86:
12: 300075	37:	62:	87:
13:	38:	63:	88:
14:	39:	64:	89:
15:	40:	65:	90:
16:	41:	66:	91:
17:	42:	67:	92:
18:	43:	68:	93:
19:	44:	69:	94:
20:	45:	70:	95:
21:	46:	71:	96:
22:	47:	72:	97:
23:	48:	73:	98:
24:	49:	74:	99:
25:	50:	75:	

(F) Network Status

(H) Secure

(I) Public

4:42pm

StarFire iTC - Shared Base Station Security

A—Rover Access List Setup
 B—Rover Access List
 C—Access List

D—Delete Rover
 E—Delete List

F—Network Status
 G—Toggle Button

H—Secure
 I—Public

Network ID must be set between 4000 - 4096 to setup and use SBS RTK security. When the network ID has been set between 4001 - 4096, the SBS RTK Security softkey will appear. Select this softkey to setup SBS RTK Security.

The SBS RTK Network operator will enter into the base station the serial numbers of RTK vehicle receivers that are allowed to access the RTK corrections from that base station. RTK vehicle serial numbers can be added and removed at any time. Only those rover serial numbers that are on the access list

on the base station receiver will be allowed to access the RTK corrections from the base station.

The StarFire iTC - Shared Base Station Security screen displays the RTK vehicle receiver serial number and location it is stored. Only the serial numbers on the RAL will be able to receive RTK corrections from the base station when RTK Network is in SECURE mode.

Access List button (C) allows operator to input the serial number of a receiver into the Access List.

Continued on next page

OUO6050,0002255 -19-25NOV06-1/7

Delete Rover button (D) allows operator to remove a receiver from the Access List.

Delete List button (E) allows operator to clear all inputted receiver serial numbers from the Access List.

SBS Security can be operated in a Public or Secure mode.

- Public – This mode does not restrict RTK vehicles from receiving RTK corrections as long as they have

the same Network ID and Frequency as the base station. This mode can be used when conducting a RTK demo for potential customers or field days.

- Secure – This mode restricts RTK vehicles from receiving RTK corrections if their serial numbers are not entered into the RAL

Network Status (F) can be toggle between secure status (H) and public status (I) using button (G).

OUG06050,0002255 –19–25NOV06–2/7

Edit Rover Access List

1. Press Access List button on StarFire iTC - Shared Base Station Security screen.
2. Enter a rover number from the Rover Access List in the entry box.

A—Rover Number (1-99)



Edit Rover Access List — Page 1

Continued on next page

OUG06050,0002255 –19–25NOV06–3/7

3. Enter the serial number of the vehicle receiver to be added to the Rover Access List in the entry box (A).

NOTE: The six digit hardware serial number can be found on StarFire iTC - Activations tab. Go to the display in RTK vehicle and press MENU >> StarFire iTC >> Activations tab.

4. Press Enter button (B) to put receiver on the Rover Access List.
5. Press Cancel button (C) to return to Rover Access List without adding receiver to list.

A—Serial Number
 B—Enter button
 C—Cancel button

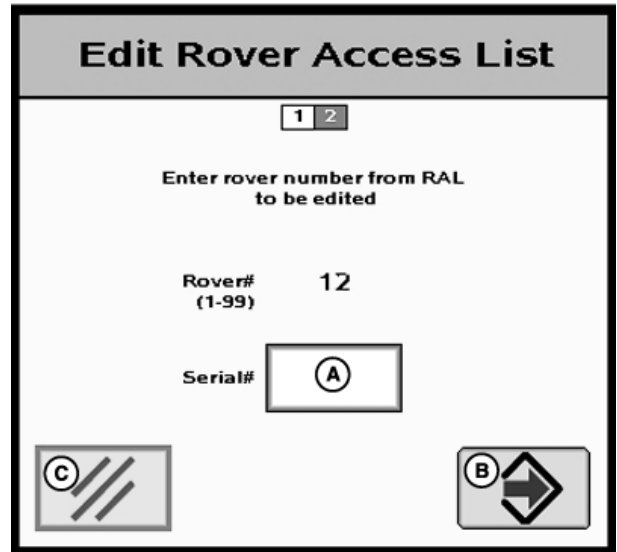

Edit Rover Access List — Page 2

OOU6050,0002255 -19-25NOV06-4/7

If the serial number is already entered on the Rover Access List, "Serial Number Already Exists." will appear on the screen.

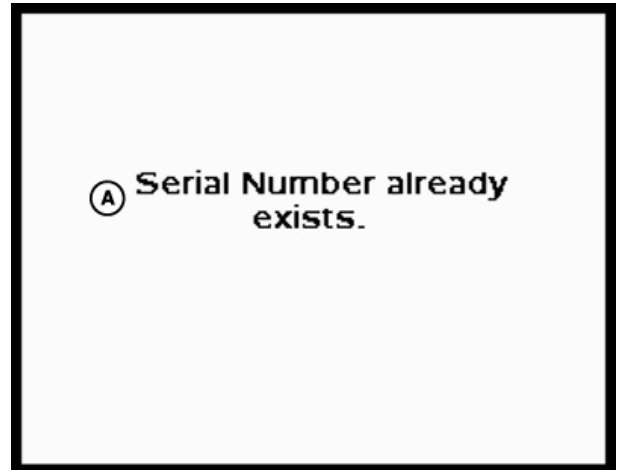

Duplicate Serial Number

Continued on next page

OOU6050,0002255 -19-25NOV06-5/7

RTK vehicle serial numbers can be deleted individually or the entire list can be deleted.

Deleting individual entries:

1. Press Delete Rover button on StarFire iTC - Shared Base Station Security screen.
2. Enter rover number to be deleted from the list.
3. Press Delete button (C) to delete the rover from the list.

NOTE: Once a RTK vehicle serial number has been deleted from the RAL, it will take approximately 18 minutes before the RTK vehicle will not longer be able to operate off of that base station. During this time the vehicle will transition into RTK extend.

NOTE: Verify RAL has been deleted by viewing RAL list .

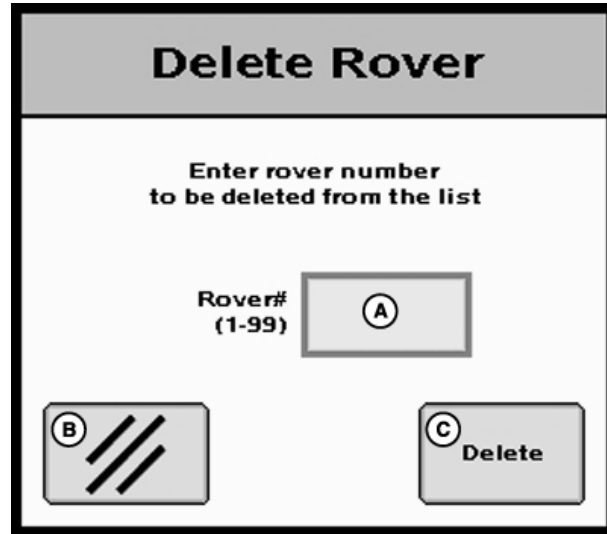

Delete Rover

- A—Rover Number (1-99)
- B—Cancel button
- C—Delete button

PC9703 -UN-10NOV06

OOU6050.0002255 -19-25NOV06-6/7

Deleting All Entries:

1. Press Delete List button on StarFire iTC - Shared Base Station Security screen.
2. Press Yes button (C) to delete all receivers from the list..

NOTE: Press No button (B) to return to StarFire iTC - Shared Base Station Security screen without deleting all the receivers from the list.



Delete Rover Access List

- A—Are you sure you want to delete entire Rover Access List?
- B—No
- C—Yes

PC9704 -UN-10NOV06

OOU6050.0002255 -19-25NOV06-7/7

RTK Vehicle Security Status

The RTK Vehicle (when operating off of a Secure Network ID) will exist in one of the three following RTK authorization states: Unknown, Authorized, or Not Authorized.

Unknown – The RTK Vehicle StarFire upon power up is in an “unknown” RTK authorization state. It will exist in this state until communication with the base station is established. No message will be displayed in cell G of the GreenStar Monitor.

Authorized – On power-up of a RTK Vehicle StarFire that is properly configured and on the authorization list, the message “RTK Network: Authorized” will be displayed in cell G as soon as it establishes communication with the secure RTK base station and it determines that it is authorized to receive RTK corrections.

Unauthorized – On power-up of a RTK Vehicle StarFire that is properly configured, but the serial number has not been entered into the base station RAL, the message “RTK Network: Not Authorized” will be displayed in cell G as soon as it establishes communication with the secure RTK base station and it determines that it is not authorized to receive RTK corrections.

Original GreenStar Display—StarFire iTC

Auto-Update

NOTE: To acquire latest version of software visit www.StellarSupport.com or contact your John Deere dealer.

When KeyCard is installed in mobile processor and power is ON, system will check version of software on mobile processor, display, and receiver. If KeyCard contains a more recent version of software, system will ask if operator wants to update with most recent version. Follow on screen procedures to update software. (See Automatic Software Load).

- A—License/Activate License Left (days)
- B—Quick Start Setup
- C—TCM Setup
- D—Diff Correction Setup
- E—Serial RS232 Output
- F—Hours ON after Shutdown
- G—

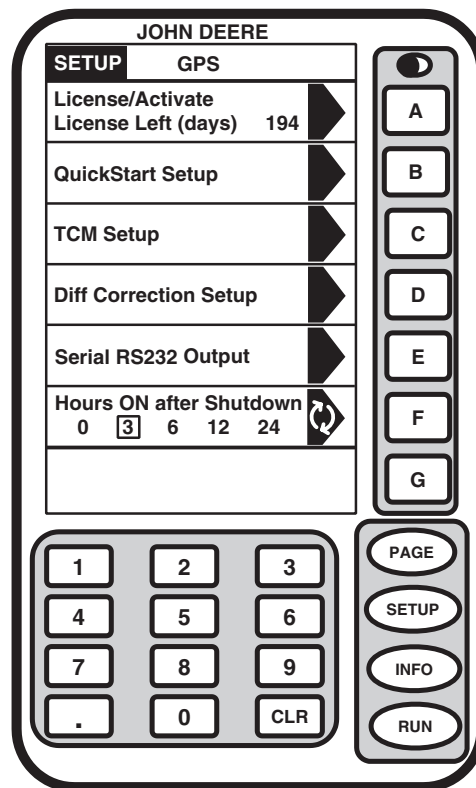

ORIGINAL GREENSTAR DISPLAY

PC9570 -UN-06NOV06

OUE6050,0002257 -19-14NOV06-1/1

Manual Software Update

NOTE: Whenever new or revised software programs are available, it will be necessary to load new software to system.

Use this procedure if automatic software load does not work.

To acquire latest version of software, visit www.stellarsupport.com or contact your John Deere dealer.

1. Install KeyCard containing new software in top slot of mobile processor.
2. Turn ignition key to RUN position.

NOTE: To cancel new software load press G.

3. **Press:** SETUP >> KEYCARD

Press letter button next to desired selection on SETUP - PRODUCTS screen.

4. Wait until WARNING PROGRAMMING screen appears and follow directions on screen.

DO NOT REMOVE PC CARD

DO NOT REMOVE POWER

5. Press letter button next to OK.
6. You may proceed as usual.

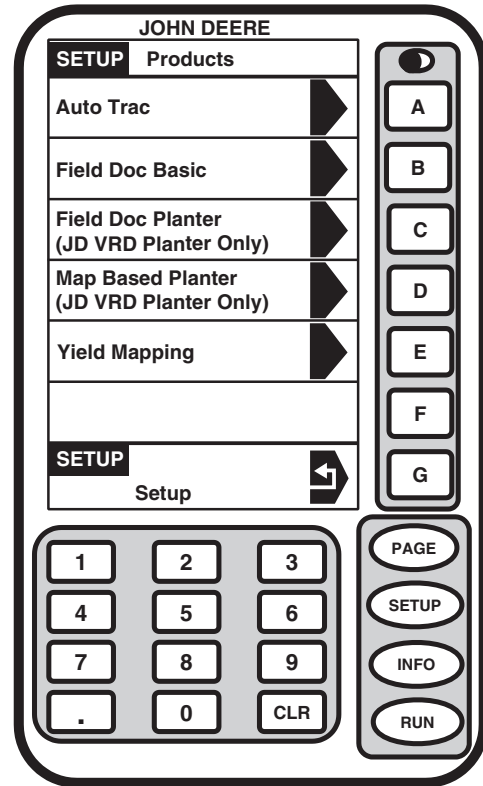

SETUP - PRODUCTS

- A—Auto Track
- B—Field Doc Basic
- C—Field Doc Planter
- D—Map Based Planter
- E—Yield Mapping
- F—
- G—Setup Return

PC9659 -UN-06NOV06

OUC6050,0002258 -19-14NOV06-1/1

StarFire Receiver

IMPORTANT: If a SF2 correction signal is being used, accuracy of system may continue to increase after SF2 is verified on screen. There may be a slight shift in position between two modes. If machine was receiving SF2 when it was shut down, warm-up period will not occur unless it has been shut down for longer that time specified for HOURS ON AFTER SHUTDOWN.

IMPORTANT: The first time StarFire iTC is powered up, it may take up to 15 minutes for receiver to acquire updated GPS almanac.

OUO6050.0002259 -19-14NOV06-1/1

SETUP-GPS-PAGE 1

Screen: SETUP - GPS

Press: SETUP >> STARFIRE RECEIVER

The following items can be setup in SETUP - GPS

- License/Activate
- QuickStart Setup
- TCM Setup
- Differential Correction Setup
- Hours on after shutdown

Press corresponding button to access option being changed.

- A—License/Activate License Left (days)
- B—Quick Start Setup
- C—TCM Setup
- D—Diff Correction Setup
- E—Serial RS232 Output
- F—Hours ON after Shutdown
- G—

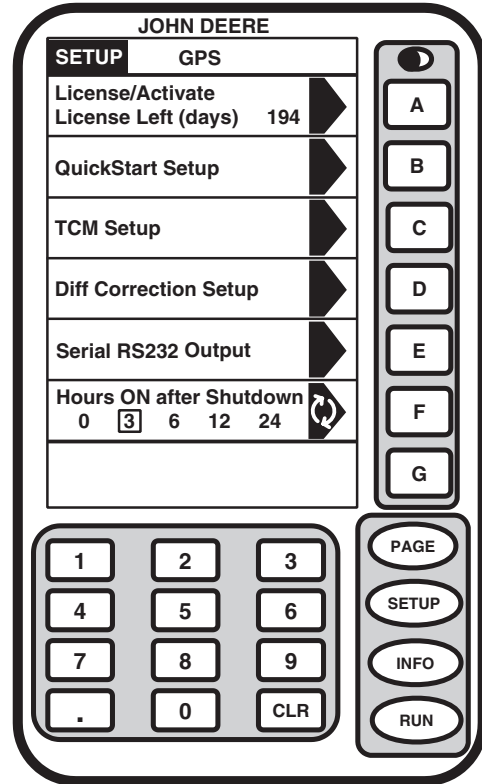

SETUP - GPS

PC9570 -UN-06NOV06

OUC6050,000225A -19-14NOV06-1/1

**Overview:
SF2/RTK Activations,
SF2 Subscription**

StarFire iTC is offered in 2 configurations: SF1 World Solution and SF2 Ready.

SF1 World Solution: SF1 is a no-charge satellite-based differential correction signal offered exclusively by John Deere, delivering accuracy adequate for non row crop applications. SF1 StarFire iTC can be upgraded to SF2-Ready by visiting your John Deere dealer, calling Customer Care Center, or visiting StellarSupport and purchasing SF2 Ready activation.

NOTE: Serial port GPS information (NMEA) is only outputted for SF1 when connected to a GreenStar system.

SF2 Ready: SF2 is a +/- 10 cm (4 in.) pass to pass differential correction signal provided exclusively by John Deere. While StarFire iTC can be ordered SF2 Ready, SF2 Ready activation must be obtained by visiting www.StellarSupport.com (COMAR order number and receiver serial number are needed) and manually entered into receiver. Once activation has been entered, SF2 license can be purchased for either a 3, 6, 12, 24, or 36 month period.

NOTE: StarFire iTC must be SF2 Ready prior to upgrading receiver to RTK.

RTK: RTK is the highest accuracy correction signal. It requires use of a local base station and radio communication equipment. Each receiver used in the RTK system must be activated for RTK. This activation exists for the life of the receiver and can be transferred.

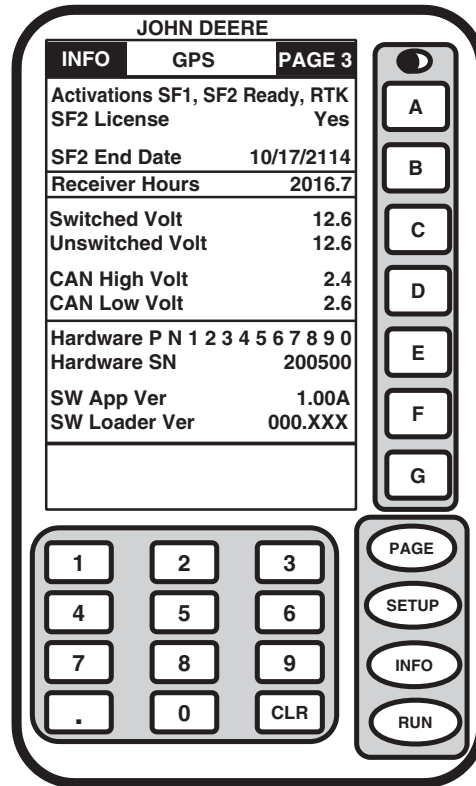

INFO - GPS - PAGE 3

- A—Activations SF1, SF2 Ready, TRK SF2 License
- B—SF2 End Date
- Receiver Hours
- C—Switched Volt
- Unswitched Volt
- D—CAN High Volt
- CAN Low Volt
- E—Hardware Part Number
- Hardware Serial Number
- F—Software Application Version
- Software Loader Version
- G—

PC9573 -JUN-06NOV06

Continued on next page

OUO6050,000225B -19-19NOV06-1/3

Obtaining and Entering SF2 or RTK activation and SF2 license

NOTE: Receiver serial number is required to obtain SF2 Ready or RTK activation codes. SF2 Ready and RTK also require corresponding COMAR order number if purchased from your John Deere dealer.

1. **Press:** INFO >> STARFIRE RECEIVER >> PAGE >> PAGE

Locate serial number (Hardware SN).

NOTE: A 24-digit activation code will be provided by www.StellarSupport.com or Customer Care Center, either through postal service or E-mail.

For RTK customers only: RTK activation is purchased as part of each RTK base station and vehicle bundle. To obtain 24 digit RTK activation code, visit StellarSupport.com and provide COMAR order number for RTK system and receiver serial numbers.

2. Login to www.stellarsupport.com to obtain activation code.

Continued on next page

OUC6050,000225B -19-19NOV06-2/3

NOTE: Enter 24 digit activation code number in three cells that have eight zero digits.

3. Screen: SETUP - STARFIRE LICENSE

Press: SETUP >> STARFIRE RECEIVER >> LICENSE/ACTIVATE

Press letter button next to DIGITS 1—8 and enter first eight digits of activation code. Press letter button next to DIGITS 1—8 again to enter value.

4. Press letter button next to DIGITS 9—16 and enter second eight digits of activation code. Press letter button next to DIGITS 9—16 again to enter value.

5. Press letter button next to DIGITS 17—24 and enter last eight digits of activation code. Press letter button next to DIGITS 17—24 again to enter value.

6. Press letter button next to SUBMIT.

7. Press letter button next to SETUP to return or SETUP button to continue setup operations.

License Expired Warning

NOTE: Three 24 hour grace periods are available when current license expires. This is provided to allow sufficient time for customer to renew a license. Grace period signal will be SF 2 differential correction signal.

If license expires while operating or since last operated, a warning screen will appear.

Warning screen can be cleared by pressing letter button next to CONTINUE or a grace period can be activated by pressing letter button next to USE 1 if needed.

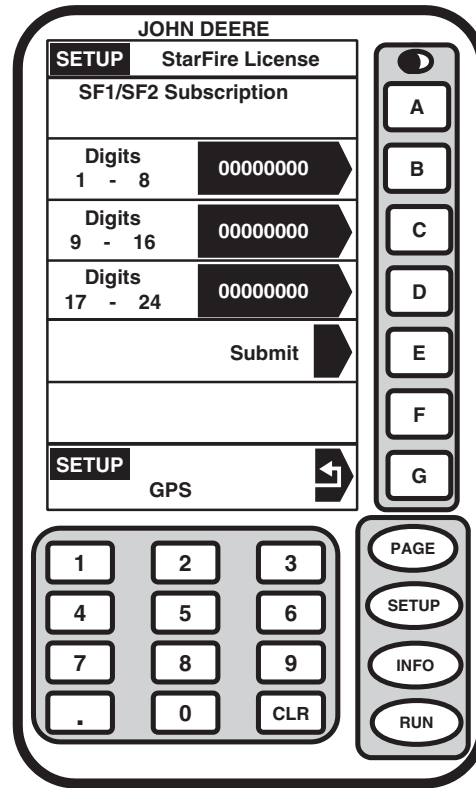

SETUP - STARFIRE LICENSE

- A—SF1/SF2 Subscription
- B—Digits 1-8
- C—Digits 9-16
- D—Digits 17-24
- E—Submit
- F—
- G—Return to GPS

PC9567 -UN-06NOV06

OUO6050,000225B -19-19NOV06-3/3

QuickStart Setup

Screen: SETUP - GPS

Press: SETUP >> STARFIRE RECEIVER >>
QUICKSTART SETUP

QuickStart reduces amount of time required before full accuracy is achieved. If QuickStart is activated (automatic mode) and receiver has SF2 when it is powered down, a position is saved for future QuickStart. If power is restored to receiver within time period defined under HOURS ON AFTER SHUTDOWN, QuickStart won't be needed since receiver power was never disrupted. If duration has exceeded HOURS ON AFTER SHUTDOWN, QuickStart will be initiated. Saved position will be used to bypass startup warm up period that is usually required. Receiver cannot move while this QuickStart is taking place. It may take up 6 minutes for QuickStart to complete. User will be notified on screen when it's done.

To activate automatic mode Press letter button next to QUICKSTART MODE to toggle between AUTOMATIC and OFF.

- A—StarFire Receiver QuickStart Setup
- B—QuickStart Mode, Automatic, Off
- C—
- D—
- E—
- F—
- G—Return to GPS Setup

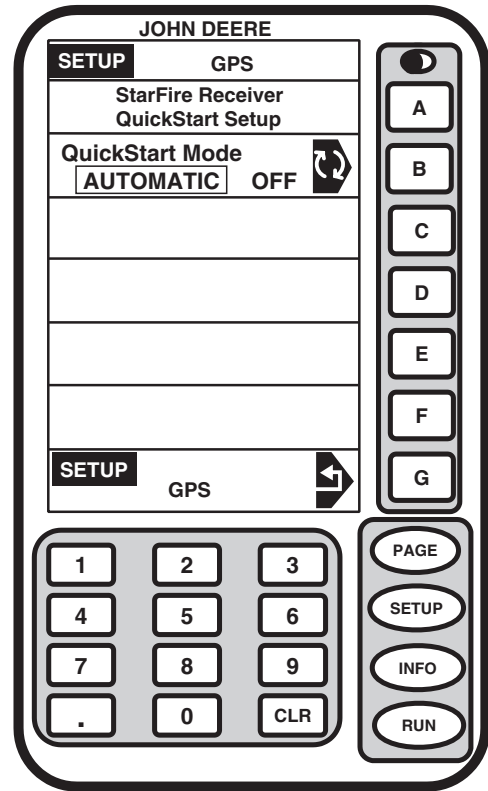

SETUP - GPS

PC9561 -JUN-06/NOV06

OU06050,000225C -19-14NOV06-1/1

Setup—TCM

Screen: SETUP - TCM

Press: SETUP >> STARFIRE RECEIVER >> TCM
SETUP

This screen allows operator to:

- Turn TCM ON/OFF
- Calibrate TCM for zero degree roll angle
- Manually insert height of receiver
- Manually insert fore/aft
- Change mounting direction of receiver

- A—TCM ON, OFF
 B—Calibrate TCM
 C—StarFire Height
 D—StarFire Fore/Aft
 E—StarFire Mount Direction, Backward, Foreward
 F—
 G—Return to Setup

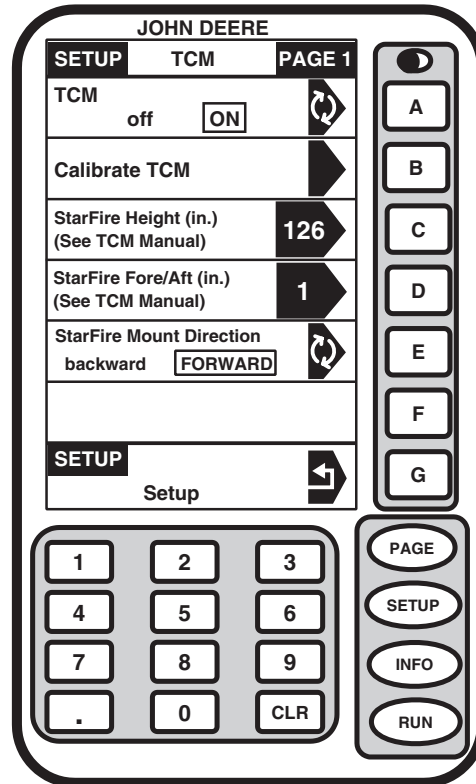

SETUP - TCM

PC9560 -JUN-06NOV06

OUO6050,000225D -19-14NOV06-1/1

ON/OFF—TCM

NOTE: There is no indication on Run Pages if TCM is ON or OFF.

TCM will default to ON when cycling power.

Press letter button A to toggle between ON and OFF selection will appear boxed and in capital letters.

When TCM is turned off, StarFire GPS messages will not be corrected for vehicle dynamics or side slopes.

OUO6050,000225E -19-14NOV06-1/1

Mounting Direction—TCM

NOTE: Receivers attached to tractors, sprayers, and combines are typically in FORWARD position.

Receivers attached to GATORS are typically in BACKWARD position.

Mounting direction is direction receiver is facing.

This setting defines mounting orientation of receiver. TCM uses this setting to determine correct direction of vehicle roll.

A StarFire receiver that extends forward from attaching bracket in direction of vehicle travel is in **FORWARD** mounting direction.

A StarFire receiver that extends backward from attaching bracket away from direction of vehicle travel is in **BACKWARD** mounting direction.

Desired selection will appear boxed and in capital letters.

Press letter button next to STARFIRE MOUNT DIRECTION and select desired mounting direction, backward or forward.

Calibrate Level—TCM

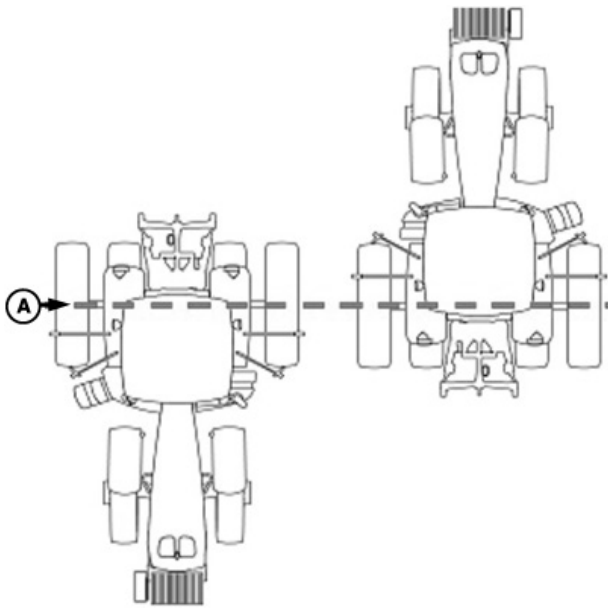

Floating Front Axle Vehicles

A—Rear Axle

PC8278 -UN-22JUN04

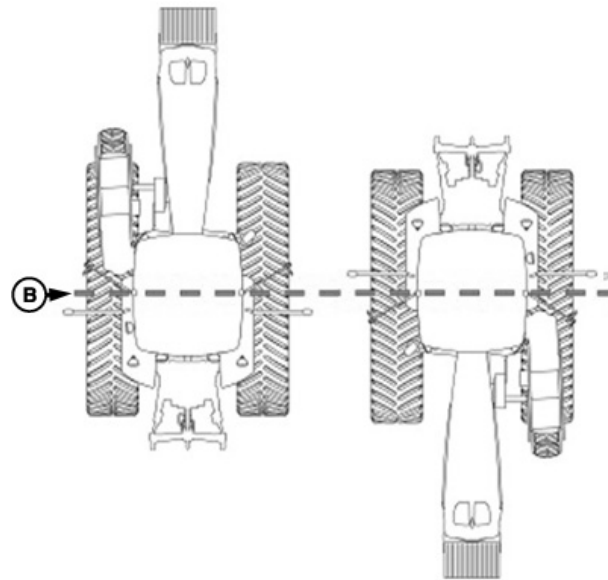

Fixed-Axis Wheels Or Tracks Vehicles

B—Vehicle Pivot Point

PC8277 -UN-01MAY06

NOTE: Calibrate receiver when it is attached or reattached to machine. Receiver does not require recalibration until removed from machine and reattached.

Positioning Machine during Calibration

IMPORTANT: When calibrating, it is important that TCM is at same angle when facing either direction. If roll angle is a positive 2° when facing one direction, vehicle needs to be a negative 2° when facing opposite direction. To position TCM at same angle it is important when turning vehicle around and facing other direction that tires are placed in correct location. Once vehicle is parked on a hard flat surface, note

location of tires on ground. When turning around use following instructions:

- **Floating Front Axle Vehicles (MFWD, ILS, TLS)**—put rear axle/wheels in same location when performing 2 point calibration. See above diagram for Floating Front Axle Vehicles.
- **Fixed-Axis Wheels Or Tracks Vehicles (Track Tractors, 9000 and 9020 Series Wheel Tractors, 4700 and 4900 Series Sprayers,)**—Place all in same location when facing either direction. See above diagram for Fixed-Axis Wheels Or Tracks Vehicles.

Continued on next page

OUC6050,0002260 -19-14NOV06-1/5

Calibration Surface

IMPORTANT: Vehicle must be on a hard, flat level surface for calibration. If TCM is not calibrated on a level surface or TCM mounting angle is not level in relation to vehicle angle (StarFire mounting bracket or vehicle cab being slightly offset, uneven tire pressures from one side to other, etc.) operator may see offset during operation. This offset could look like a consistent skip (A) or overlap (B) in pass-to-pass operation. To eliminate offset, re-calibrate on a level surface, drive down a pass, turn around and drive down same pass in opposite direction. If vehicle does not follow same pass, measure offset distance and enter in implement offset in **SETUP - TRACKING - PAGE 2**. See implement offset section. After initial calibration of TCM, it is not necessary to calibrate again unless TCM angle in relation to vehicle has changed. For example, tire pressure has been lowered on one side of vehicle causing vehicle angle in relation to ground to change.

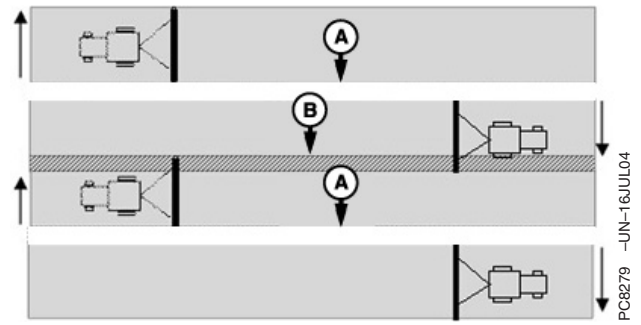

A—Skip
B—Overlap

Continued on next page

OOU6050,0002260 -19-14NOV06-2/5

Screen: SETUP - TCM

Press: SETUP >> STARFIRE RECEIVER >> TCM
SETUP >> CALIBRATE LEVEL

1. Once vehicle is on a hard, level surface and has come to a complete stop (cab is not rocking), Press letter button next to CONTINUE.

- A—
- B—Park Vehicle on level surface.
- C—Press Continue to calibrate the TCM
- D—
- E—
- F—Continue
- G—Cancel

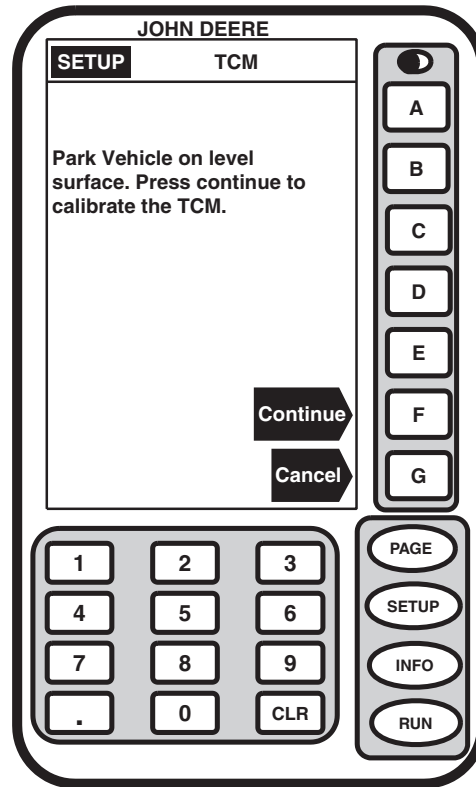

SETUP - TCM

PC9568 -JUN-06/NOV06

Continued on next page

OUC6050.0002260 -19-14NOV06-3/5

NOTE: While calibrating, TCM will provide a warning if it detects vehicle roll angle is greater than 10° relative to internal axis of TCM. If vehicle is on a level surface and yet warning is displayed, check mounting orientation of TCM and verify it is aligned within 10° of vehicle axis.

2. Turn vehicle 180° to face opposite direction. Ensure that tires are in proper location for fixed or floating front axle.
3. Ensure vehicle has come to a complete stop (cab is not rocking) and Press letter button next to CONTINUE.

- A—
- B—Position Vehicle in the opposite direction at the same location.
- C—Press continue when ready.
- D—
- E—
- F—Continue
- G—Cancel

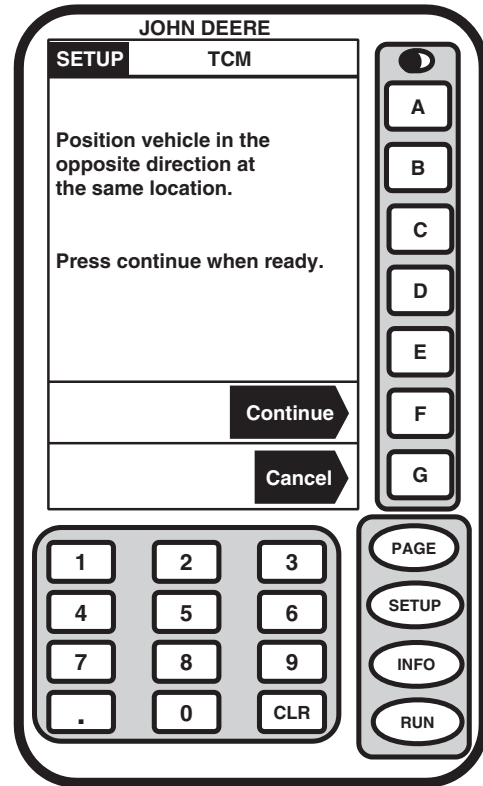

TCM calibration complete

PC9563 -UN-06NOV06

Continued on next page

OUC6050,0002260 -19-14NOV06-4/5

4. Press letter button next to OK.

5. Once finished, a calibration value will be displayed.
The 0° calibration value is the difference between the factory calibration value and actual calibration value which was just determined.

- A—
- B—
- C—
- D—TCM calibration complete.
- E—0 degree Calibration Value
- F—
- G—OK

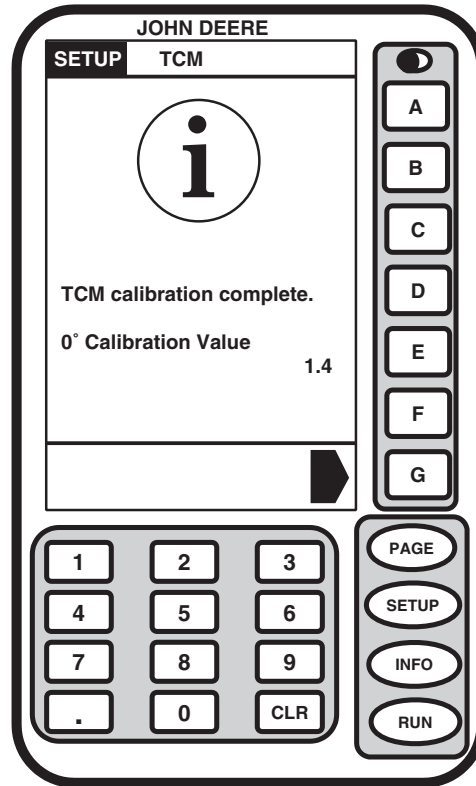

Setup - TCM

PC9564 -UN-06NOV06

OUO6050,0002260 -19-14NOV06-5/5

Height—TCM

IMPORTANT: Under or over compensation for vehicle roll angles will occur if height is incorrectly entered during setup (i.e. on a 10° slope with a StarFire height error of 12 inches will result in a position offset of 2 inches on ground).

Factory default setting is “126”. On some AutoTrac-equipped vehicles, height value will be automatically detected and entered during power up. Because this dimension is critical for proper operation of TCM and can vary due to vehicle configuration and tire sizes, operator should still measure actual distance to be entered each time TCM is installed on a different vehicle.

Height is measured from ground to top of StarFire Dome.

NOTE: Use chart for example StarFire Height values.

Press letter button next to STARFIRE HEIGHT and enter height using numeric keypad.

Press letter button next to STARFIRE HEIGHT again to save number.

NOTE: Chart figures are approximate heights.

John Deere Vehicle	StarFire Height cm (in.)
6000 Series Tractors	280 cm (111 in.)
7000 Series Tractors	305 cm (120 in.)
8000 Series Tractors	320 cm (126 in.)
8000T Series Tractors	320 cm (126 in.)
9000 Series Tractors	361 cm (142 in.)
9000T Series Tractors	356 cm (140 in.)
4700 Series Sprayers	389 cm (153 in.)
4900 Series Sprayers	396 cm (156 in.)
Combine	396 cm (156 in.)

Fore/Aft—TCM

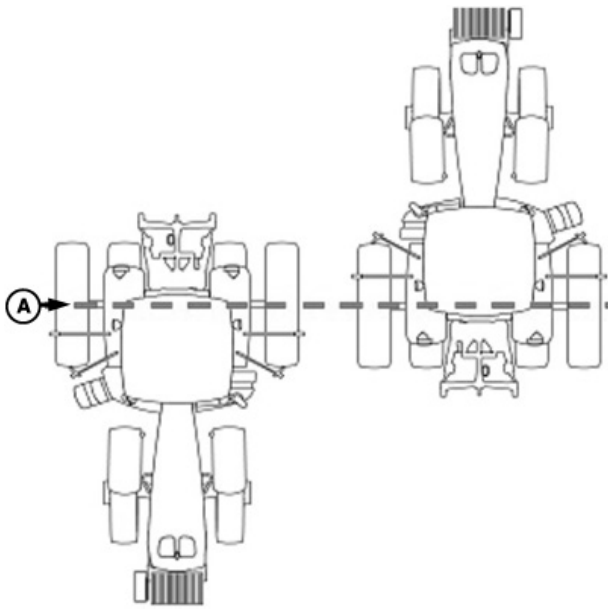

PC8278 -UN-22JUN04

Floating Front Axle Vehicles

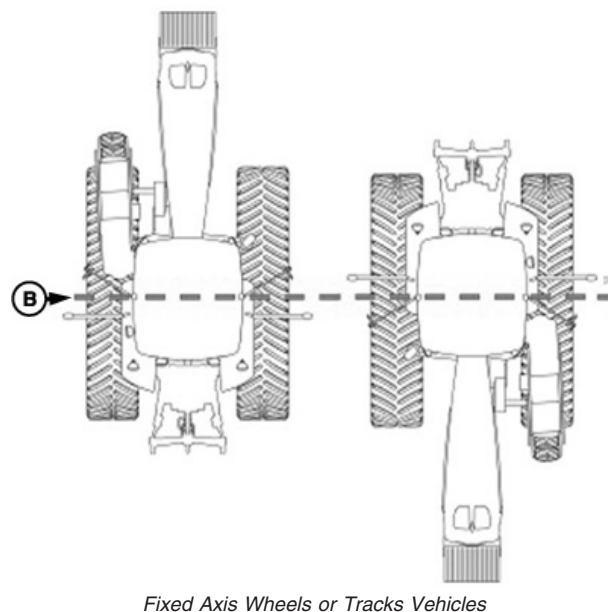

PC8277 -UN-01MAY06

Fixed Axis Wheels or Tracks Vehicles

A—Pivot Point—Floating Front Axle Vehicles-

B—Pivot Point—Fixed Axis Wheels or Tracks Vehicles

TCM Fore/Aft value is distance that receiver is located from pivot point of tractor.

On some AutoTrac-equipped vehicles, fore/aft value will be automatically detected and entered during power up.

- Fore/Aft value is shown **without** black text box—Automatically detected and cannot be changed. The value shown may not be the exact distance that the receiver is located from pivot point of tractor, but the best value for AutoTrac.
- Fore/Aft value is shown **with** black text box—Must be entered manually.

Perform following procedure to select and manually enter value. Use chart to select StarFire Fore/Aft values if necessary.

If using TCM for Parallel Tracking on a vehicle not listed in chart, then enter "1" for fore/aft setting.

Press letter button next to STARFIRE FORE/AFT and enter value using numeric keypad.

Press letter button next to STARFIRE FORE/AFT again to save entered value.

Recommended StarFire Fore/Aft values For John Deere Vehicles	
John Deere Vehicle	StarFire Fore/Aft cm (in.)
6000 Series Tractors	180 cm (71 in.)
7000 Series Tractors	210 cm (82.5 in.)
8000 Series Tractors	210 cm (82.5 in.)
8000T Series Tractors	51 cm (20 in.)
9000 Series Tractors	-51 cm (-20 in.)
9000T Series Tractors	51 cm (20 in.)
4700 Series Sprayers	280 cm (110 in.)
4900 Series Sprayers	460 cm (181 in.)
Combine	220 cm (87 in.)
Forage Harvester	157 cm (62 in.)

Differential Correction Setup

Differential correction is the process by which GPS accuracy is improved. (See OVERVIEW: SF1/SF2 ACTIVATIONS, SF2 SUBSCRIPTION in this section.)

Screen: SETUP - DIFF CORRECTION

Press: SETUP >> STARFIRE RECEIVER >> DIFF CORRECTION SETUP

(See RTK section for RTK Setup.)

IMPORTANT: DO NOT change default StarFire Correction Frequency unless instructed to do so by your John Deere Dealer or by John Deere Ag Management Solutions.

NOTE: Some information will only appear when receiver has a license.

Press letter button next to STARFIRE CORRECT FREQ to toggle between DEFAULT and BELOW.

When STARFIRE CORRECT FREQ is set to BELOW—press letter button next to FREQ (MHz) then input a frequency.

Press letter button next to STARFIRE CORRECTION to toggle between OFF, SF1, and SF2. If toggled to OFF, StarFire will not receive SF1 or SF2 correction signals. If receiver does not have a valid SF2 license then SF2 will not appear on screen.

Press letter button next to WAAS CORRECTION to toggle between OFF and ON. If toggled to OFF, StarFire will not receive WAAS correction signals.

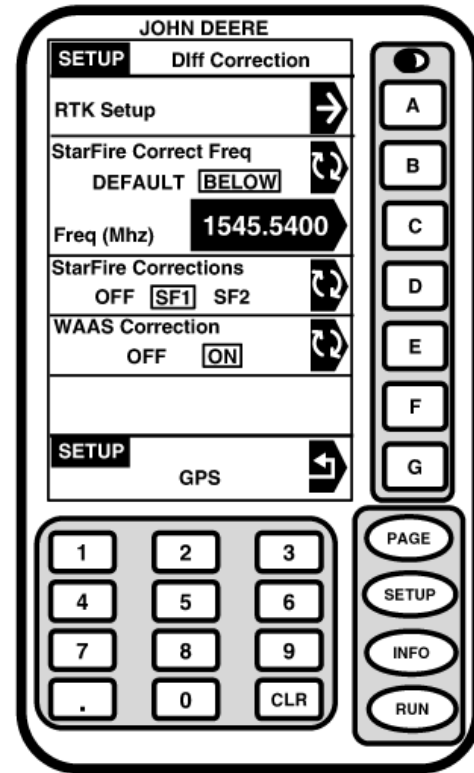

SETUP - DIFF CORRECTION

- A—RTK Setup
- B—StarFire Correction Frequency, Default, Below
- C—Frequency
- D—StarFire Corrections, Off, SF1 SF2
- E—WAAS Correction, Off, On
- F—
- G—Return to GPS Setup

PC9735 -JUN-19NOV06

OOU6050,0002263 -19-14NOV06-1/1

Serial RS232 Output

Screen: SETUP - SERIAL PORT

Press: SETUP >> STARFIRE RECEIVER >> SERIAL RS232 OUTPUT

NOTE: NMEA serial port data is outputted for SF1 only when connected to a GreenStar system. NMEA serial port data is always outputted for SF2 and RTK.

These settings are only for NMEA serial port messages for communication with non-GREENSTAR systems.

Serial port baud output rates are: 4800, 9600, 19200 and 38400.

The following items can be setup in SETUP - SERIAL PORT screen:

- Serial Port Baud Rate
- Serial Port Output Rate
- GGA Port Message
- GSA Port Message
- RMC Port Message
- VTG Port Message
- ZDA Port Message

Press letter button next to desired cell, toggle to desired selection.

Serial Port Output Rate

NOTE: Serial port settings do not affect GreenStar applications.

Press letter button next to SERIAL PORT OUTPUT RATE to toggle/select from 1 to 5 Hz.

Serial Port Messages

Press letter button next to SERIAL PORT MESSAGE to toggle/select between ON and OFF.

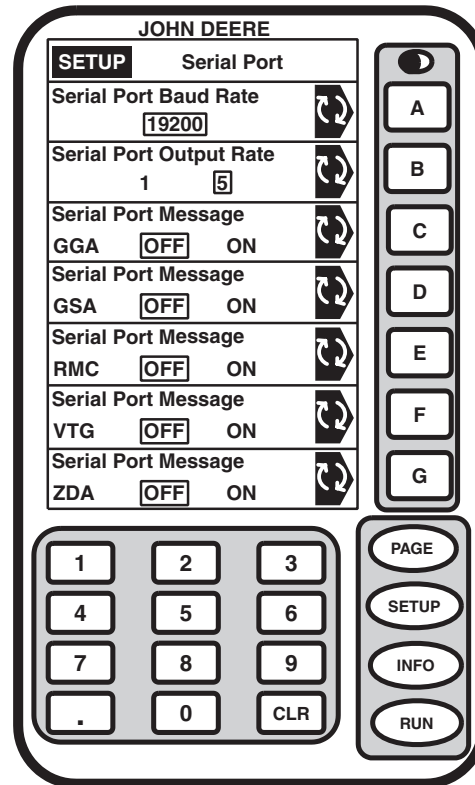

SETUP - SERIAL PORT

- A—Serial Port Baud Rate
- B—Serial Port Output Rate, 1, 5
- C—Serial Port Message, GGA, OFF, ON
- D—Serial Port Message, GSA, OFF, ON
- E—Serial Port Message, RMC, OFF, ON
- F—Serial Port Message, VTG, OFF, ON
- G—Serial Port Message, ZDA, OFF, ON

FC9569 -JUN-06/NOV06

Hours On After Shutdown

Screen: SETUP - GPS

Press: SETUP >> STARFIRE RECEIVER

Button next to HOURS ON AFTER SHUTDOWN defines how long receiver remains powered after ignition is turned off (0, 3, 6, 12 or 24 hours). If ignition is turned on within number of hours defined, receiver will re-establish full SF2 accuracy within a few seconds (assuming it had SF2 when ignition was turned off).

Operator can select amount time in hours system will stay on. Press letter button next to HOURS ON AFTER SHUTDOWN to toggle between settings. Setting from factory is 3 hours.

- A—License/Activate License Left (days)
- B—Quick Start Setup
- C—TCM Setup
- D—Diff Correction Setup
- E—Serial RS232 Output
- F—Hours ON after Shutdown
- G—

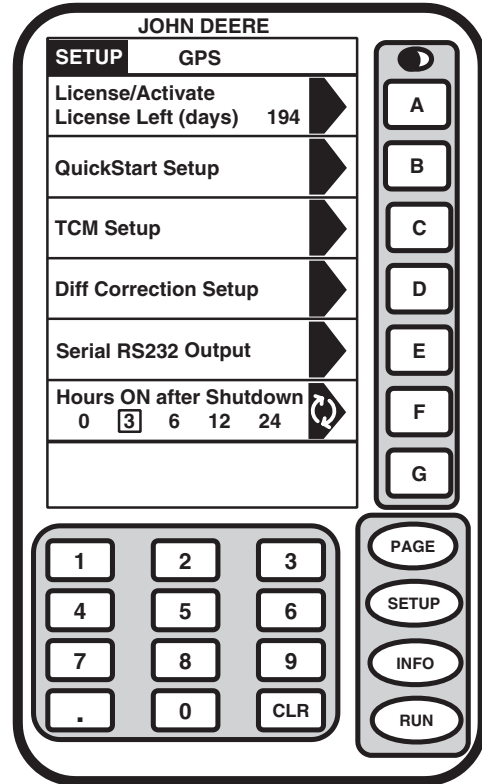

SETUP - GPS

PC9570 -JN-06NOV06

OUO6050,0002265 -19-14NOV06-1/1

INFO - GPS - PAGE 1**Screen:** INFO - GPS - PAGE 1**Press:** INFO >> STARFIRE RECEIVER

This screen shows information and status of incoming GPS and differential correction signals. No information on this screen can be changed. It is for viewing only.

Date and Time: This cell shows date and time for Greenwich Mean time.

Lat: This cell displays vehicle location latitude coordinates with respect to Equator (north or south).

Lon: This cell shows vehicle location longitude coordinates with respect to Prime Meridian (east or west).

NOTE: Toggle button allows operator to change the way latitude and longitude are displayed between degrees, minutes, seconds and decimal degrees.

Altitude: This cell shows height of receiver, measured from top of dome, in meters (feet) above sea level.

GPS Course: This cell displays direction of travel, in degrees, relative to true north (zero degrees) as measured by receiver. Angle is measured in clockwise direction.

NOTE: Course and speed normally show small speeds and various courses even when machine is not moving.

GPS Speed: This cell shows ground speed of machine in kilometers per hour (mile per hour) as measured by receiver.

Position Mode: This cell indicates whether receiver is calculating a 3D position, 2D position, or no position (no nav). It also shows status of differential signal: SF 1 (StarFire 1 differential), SF 2 (StarFire 2 differential).

Differential Mode: This cell shows status of GPS signal: 2-D (two dimensional with latitude and longitude of vehicle) or 3-D (three dimensional with altitude, latitude, and longitude of vehicle).

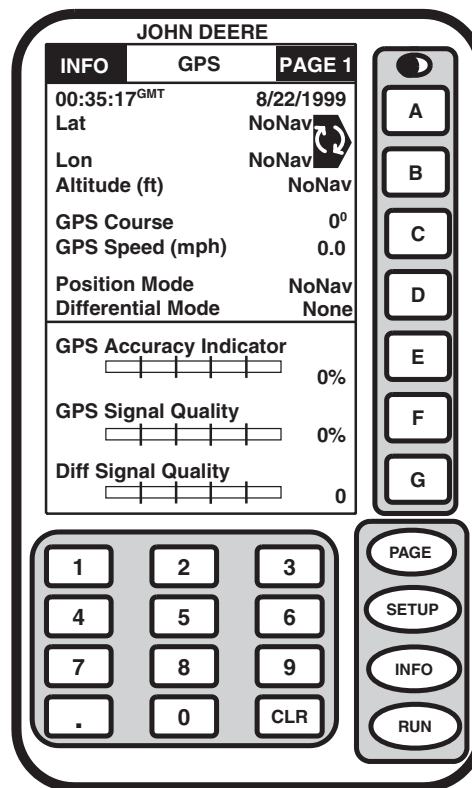

INFO - GPS - PAGE 1

- A—Latitude
- B—Longitude
- Altitude
- C—GPS Course
- GPS Speed
- D—Position Mode
- Differential Mode
- E—GPS Accuracy Indicator
- F—GPS Signal Quality
- G—Differential Signal Quality

PC9576 - JUN-06/NOV06

Continued on next page

OUO6050,0002266 -19-14NOV06-1/2

GPS Accuracy Indicator: StarFire iTC includes GPS Accuracy Indicator (GPS AI). GPS AI gives indication of GPS position accuracy achieved by receiver, and is displayed as a percentage (0-100%). GPS AI is displayed on RUN Page of Parallel Tracking (Figure 1), AutoTrac, and Field Doc and INFO – GPS – Page 1 (Figure 2).

When receiver is initially powered, GPS AI will display 0%. As receiver acquires satellites and calculates a position, GPS AI will increase as accuracy improves. Acceptable guidance performance for Parallel Tracking and AutoTrac is achieved when GPS AI displays 80% or greater. This may take up to 20 minutes. GPS accuracy is affected by many factors. If 80% accuracy or greater is not achieved within 25 minutes, consider following possibilities:

- Unobstructed view of sky – trees, buildings, or other structures may block receiver from receiving signals from all available satellites
- L1/L2 signal to noise ratio (SNR) – radio interference from 2-way radios or other sources may cause low SNR
- Satellite position in sky – poor GPS satellite geometry can reduce accuracy
- Number of satellites above elevation mask – this is total number of GPS satellites available to your receiver that are above 7° elevation mask
- Number of satellites in solution – this is total number of satellites that are being used by receiver to calculate a position

GPS Signal Quality: This cell shows quality of signals being received from constellation of GPS satellites.

Differential Signal Quality: This cell shows quality of differential correction signal being received by receiver.

INFO - GPS - PAGE 2

Screen: INFO - GPS - PAGE 2

Press: INFO >> STARFIRE RECEIVER >> PAGE

Diagnostic Trouble Codes: (See DIAGNOSTIC TROUBLE CODES in Troubleshooting section.)

Data Log: Three data log pages consist of graphs showing GPS information for up to previous 60 minutes. Graphs can be used to show user any variation that has occurred in last 60 minutes.

Freq (MHz): This cell shows frequency of differential correction signal that receiver is set to receive.

Corrections Age (SEC): This cell shows age of differential correction signal to GPS (normally less than 10 seconds).

Sats Above Elev Mask: This is total number of GPS satellites available to your receiver that are above 7° elevation mask.

Satellites Tracked: This is total number of GPS satellites tracked by your receiver.

Satellites in Solution: This cell shows number of satellites actively used to compute position.

PDOP: PDOP (Position Dilution of Precision) is an indicator of GPS satellite geometry as viewed by receiver. A lower PDOP indicates better satellite geometry for calculating both a horizontal and vertical position.

Roll Angle: Is both graphical and numerical representation of amount of roll TCM is measuring, relative to calibrated zero degree reference. A positive roll angle means vehicle is rolled to right.

Yaw Rate: This gives a graphic representation and a numeric figure for amount of rotation TCM is measuring. Positive yaw rate means vehicle is turning to right.

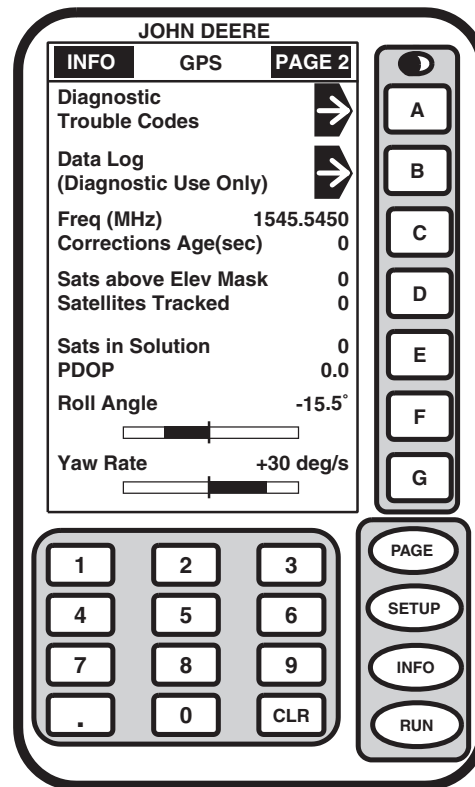

INFO - GPS - PAGE 2

A—Diagnostic Trouble Codes
 B—Data Log (Diagnostic Use Only)
 C—Frequency
 Corrections Age
 D—Satellites above Elevation Mask
 Satellites Tracked
 E—Satellites in Solution
 PDOP
 F—Roll Angle
 G—Yaw Rate

FC9566 -UN-06NOV06

Data Log

Screen: INFO - GPS - PAGE 2

Press: INFO >> STARFIRE RECEIVER >> PAGE

Press letter button next to DATA LOG to access three data log pages. These pages consist of graphs showing GPS information for up to previous 60 minutes. Graphs can be used to show user any variation that has occurred in last 60 minutes.

- A—Diagnostic Trouble Codes
- B—Data Log (Diagnostic Use Only)
- C—Frequency Corrections Age
- D—Satellites above Elevation Mask Satellites Tracked
- E—Satellites in Solution PDOP
- F—Roll Angle
- G—Yaw Rate

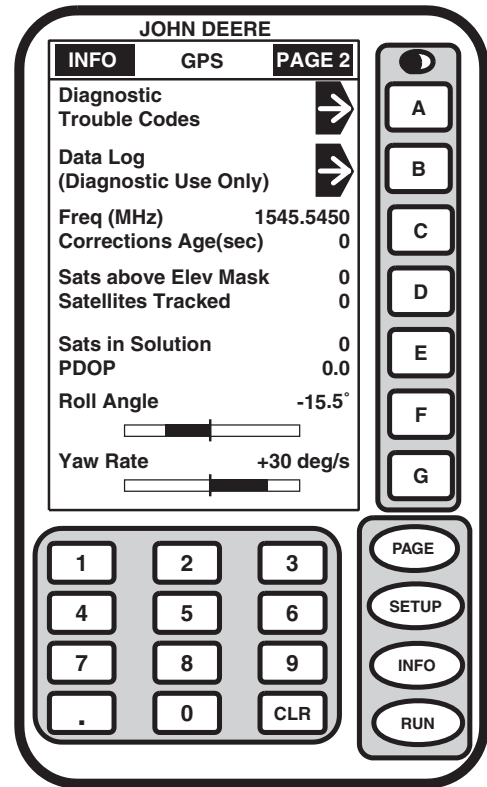

INFO - GPS - PAGE 2

PC9566 -UN-06NOV06

Continued on next page

OUC6050,0000C39 -19-17OCT07-1/4

INFO - DATA LOG - PAGE 1

Screen: INFO - DATA LOG - PAGE 1

Press: INFO >> STARFIRE RECEIVER >> PAGE >> DATA LOG

GPS Accuracy Indicator: GPS Accuracy Indicator is a relative indication of overall differential GPS performance.

GPS Signal Quality: GPS signal quality shows quality of signals being received from GPS satellites. Unlike GPS Accuracy Indicator, Signal Quality doesn't include EGNOS, SF1, SF2, or amount of time signal is received.

Differential Signal Quality: Differential signal quality is strength of StarFire network signal (SF2 or SF1). Normal range is from 5 to 15, but maximum reading on indicator is 10. Numerical value is displayed to right of indicator. Any value above 5 is normal.

- A—GPS Accuracy Indicator
- B—
- C—GPS Signal Quality
- D—
- E—Differential Signal Quality
- F—
- G—Return to GPS Info

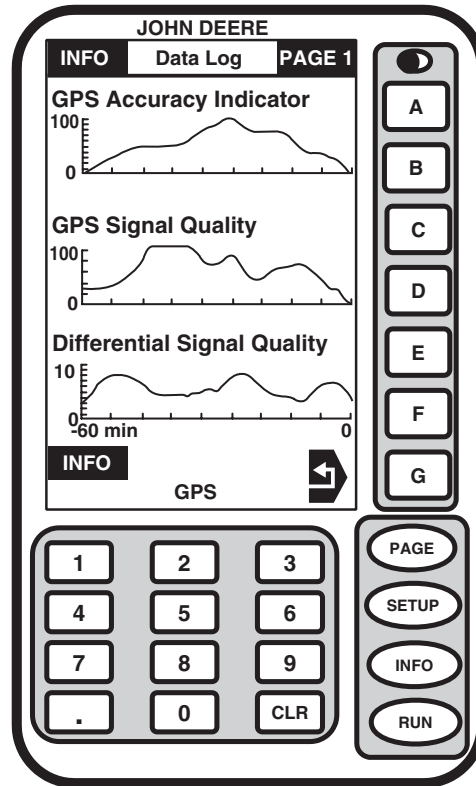

INFO - DATA LOG - PAGE 1

PC9571 -JUN-06NOV06

Continued on next page

OUO6050,0000C39 -19-17OCT07-2/4

INFO - DATA LOG - PAGE 2

Screen: INFO - DATA LOG - PAGE 2

Press: INFO >> STARFIRE RECEIVER >> PAGE >> DATA LOG >> PAGE

PDOP: (Position Dilution Of Precision) is a combination of vertical and horizontal error (or three dimensional). Lower PDOP is better. A value below 2 is considered optimal.

Satellites in Solution: Number of satellites that receiver is using in current position solution. Maximum is 12. Satellites in solution are not tracked until they get above 7° elevation mask.

- A—PDOP
- B—
- C—
- D—Satellites Used
- E—
- F—
- G—Return to GPS Info

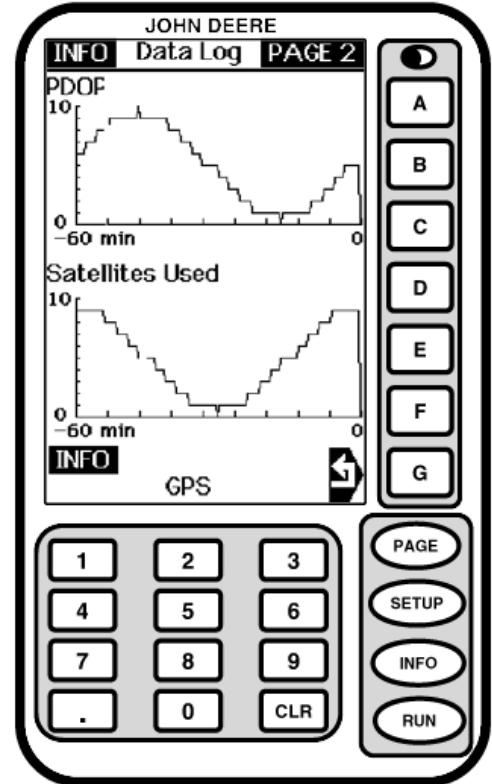

INFO - DATA LOG - PAGE 2

PC9587 -UN-06NOV06

Continued on next page

OUC6050,0000C39 -19-17OCT07-3/4

INFO - DATA LOG - PAGE 3

Screen: INFO - DATA LOG - PAGE 3

Press: INFO >> STARFIRE RECEIVER >> PAGE >> DATA LOG >> PAGE >> PAGE

Position Mode: Position mode is represented as three different types; No Nav, 2D and 3D. This helps determine if GPS position has been dropped in last 60 minutes.

Differential Mode: This shows level of differential signal that you have been receiving over past 60 minutes. Level of signal that you purchased on your receiver will determine highest point on bar graph that you will see.

- RK - RTK
- RG - current SF2
- WT - original SF2
- WS - EGNOS
- NO - none

- A—Navigation Mode
- B—
- C—
- D—Differential Mode
- E—
- F—
- G—Return to GPS Info

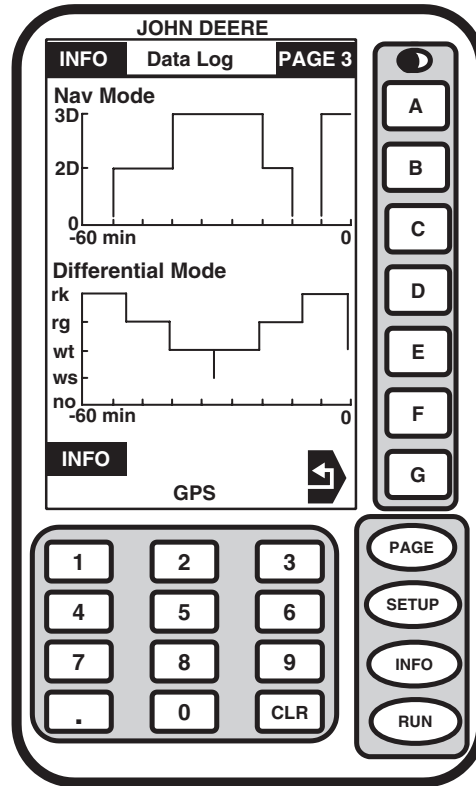

INFO - DATA LOG - PAGE 3

PC9572 -JUN-06NOV06

OUO6050,0000C39 -19-17OCT07-4/4

INFO - GPS - PAGE 3

Screen: INFO- GPS - PAGE 3

Press: INFO >> STARFIRE RECEIVER >> PAGE >> PAGE

This page shows detailed information about receiver. This information will help troubleshoot receiver if a problem occurs.

Activations: Activations displays all activation codes that have been entered into receiver. SF1, SF2, and/or RTK. Visit www.StellarSupport.com for additional activations.

SF2 License: If receiver currently has active SF2 license, YES will be displayed. If not, NO will be displayed.

SF2 End Date: Date SF2 license will expire.

Receiver Hours: This cell displays number of hours on receiver.

Serial Number: This cell shows receiver serial number. This is required to obtain a StarFire signal license.

Hardware Version: This cell shows part number of receiver.

Software Version: This cell displays version of software being used by receiver.

NOTE: To acquire the latest version of software, visit www.stellarsupport.com or contact your John Deere dealer.

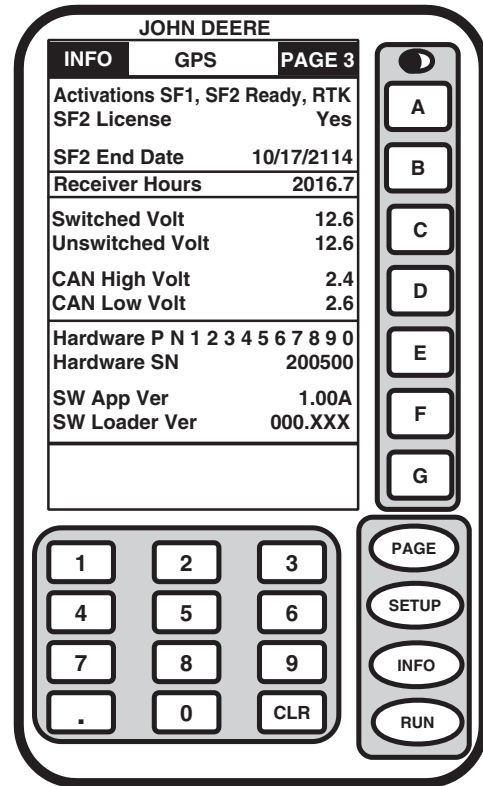

INFO - GPS - PAGE 3

- A—Activations SF1, SF2 Ready, TRK SF2 License
- B—SF2 End Date Receiver Hours
- C—Switched Volt Unswitched Volt
- D—CAN High Volt CAN Low Volt
- E—Hardware Part Number Hardware Serial Number
- F—Software Application Version Software Loader Version
- G—

PC9573 -UN-06NOV06

OOU06050,0002269 -19-14NOV06-1/1

Satellite Tracking

Screen: INFO- GPS - PAGE 4

Press: INFO >> STARFIRE RECEIVER >> PAGE >> PAGE >> PAGE

This page shows satellites being tracked by GPS receiver and associated information.

SAT ID: (Satellite Identification Number): Identification number for GPS satellite

ELV: (Position Elevation): Elevation in degrees above horizon for GPS satellite position

AZM: (Position Azimuth): Azimuth in degrees from true North for GPS satellite

L1 SNR: (L1 Signal to Noise Ratio): Signal strength for L1 GPS signal (signal to noise ratio)

L2 SNR: (L2 Signal to Noise Ratio): Signal strength for L2 GPS signal (signal to noise ratio)

Status: (GPS Signal Status): Status of GPS signal

- **Search:** searching for satellite signal
- **Track:** tracking satellite signal and using it for positioning
- **OK:** tracking satellite signal and using it for positioning
- **OK SF1:** tracking satellite signal and using it for positioning with STARFIRE signal frequency
- **OK SF2:** tracking satellite signal and using it for positioning with STARFIRE dual frequency

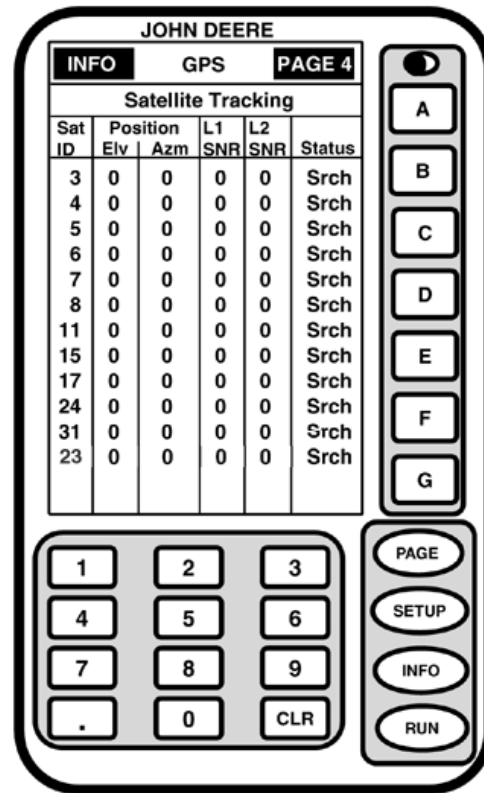

INFO - GPS - PAGE 4

- A—Satellite Tracking
- B—Satellite ID, Elevation, Azimuth, L1 SNR, L2 SNR, Status
- C—
- D—
- E—
- F—
- G—

PC9585 -JUN-06NOV06

OUC6050,000226A -19-14NOV06-1/1

Original GreenStar Display—RTK

Operating Mode

IMPORTANT: Before starting SETUP procedures, enter RTK activation number, see Enter RTK Activation section.

NOTE: Radio can function in four different modes:

- Vehicle
- Quick Survey Base Mode
- Absolute Base Mode
- Off

Check that base station, vehicle, and repeater have same Frequency, Network ID and Time Slot.

Screen: SETUP - RTK

Press: SETUP >> STARFIRE RECEIVER >> DIFF CORRECTION SETUP >> RTK SETUP

Press letter button next to RTK OPERATION MODE and toggle to desired selection.

Suggested Base Station Mode For Operation	
Quick Survey Base Mode	Absolute Base Mode
Custom Operations	Drip Tape
Tillage	Strip Till
Broad-acre Seeding	Controlled Traffic
	Row Crop

Vehicle Mode: Select for receiver on vehicle.

Vehicle Repeater Mode: This mode should only be used in situations where multiple RTK vehicles are operating in the same field and due to the terrain, line-of-sight is obstructed between one of the vehicles and the base station.

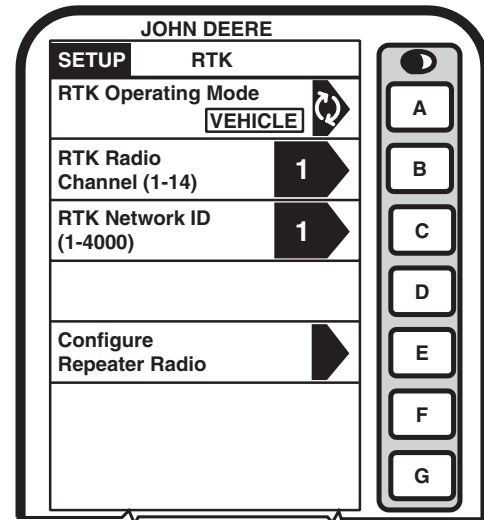

SETUP - RTK

- A—RTK Operating Mode
- B—RTK Radio Channel
- C—RTK Network ID
- D—
- E—Configure Repeater Radio
- F—
- G—

PC9577 -UN-06NOV06

Continued on next page

OJ06050,0000C3C -19-17OCT07-1/2

Quick Survey Base Mode: Select if exact location of guidance tracks do not need to be stored for future applications. If Quick Survey Base Mode is used to establish rows or paths that will be used at a later date, location of Track 0 must be saved using Current Field setting in Tracking Setup (see AutoTrac Operator's Manual). When Current Field is recalled, a one-time use of Shift Track feature will be needed to align vehicle on previous tracks. See Setup Quick Survey Base Mode section.

Absolute Survey Base Mode: Select if exact location of guidance tracks need to be stored for future guidance applications without relying on visual reference for track position to align using Shift Track feature. Track 0 must be stored using Current Field in Tracking Setup in order to follow previously used tracks. Absolute Base Mode requires 24-hour self survey to be conducted on location before first use. After survey is completed, base station will then transmit corrections. If base station is moved to another position and then returned to original surveyed position, it is very important that base station is mounted in exact same position. Any difference between original surveyed position and mounted position will result in offset of corrected position. For this reason, it is important to mount receiver to a fixed position like building or post mounted in concrete.

OFF Mode: This mode disables all RTK functionality in receiver. RTK Operating Mode must be OFF for normal SF2 operation on SF2-licensed receiver.

Vehicle Repeater

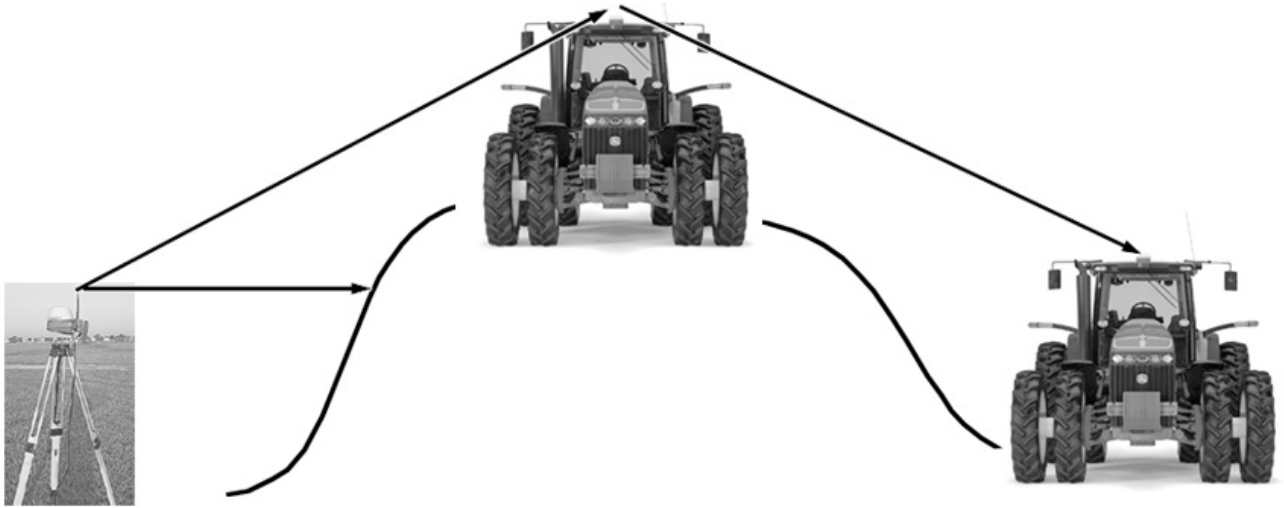

Press: SETUP button >> StarFire iTC >> Differential Correction Setup (D) >> RTK Setup (A)

Toggle (A) button next to RTK Operating Mode until "VEHICLE REPEATER" appears in the cell.

In this mode the RTK vehicle radio not only receives messages but also rebroadcasts them (similar to a RTK repeater) to other RTK vehicles in close proximity.

NOTE: Vehicle Repeater is identical to the Vehicle mode with the addition of having the radio rebroadcast the RTK messages.

The Vehicle Repeater mode allows an RTK vehicle to function normally as an RTK vehicle while also

transmitting the base correction signal to another RTK vehicle that does not have line-of-sight to the base station.

The 'Vehicle Repeater' needs to be between the base station and the 'Vehicle'. The 'Vehicle Repeater' must be able to communicate with the base station. The 'Vehicle' must then have either line of sight communication to the base station or 'Vehicle Repeater'.

IMPORTANT: There should be only ONE Vehicle Repeater or Repeater in the same vicinity with the same Network ID.

OUC6050,0000C3D -19-24SEP07-1/1

PC9148 -UN-20APE06

Quick Survey Mode

NOTE: Display is not required after base station receiver has been configured to operate in Quick Survey Base Mode and RTK Frequency, Radio Channel/Network ID have been set.

Check that base station, vehicle, and repeater have same Frequency, Network ID and Time Slot.

Connect display to base station.

Screen: SETUP - RTK

Press: SETUP >> STARFIRE RECEIVER >> DIFF CORRECTION SETUP >> RTK SETUP

NOTE: Quick Survey Base Mode allows base station to broadcast corrections after receiver calculates GPS position.

If power is removed from base station (but not moved) power can be restored and same base station position will be used for corrections. If previously used Track 0 is recalled in Parallel Tracking/Auto Trac no Shift Track will be needed.

If power is removed and base station is moved, a new position will be calculated when power is restored. If previously used Track 0 is recalled in Parallel Tracking/Auto Trac, use Shift Track. (See AutoTrac Operator's Manual for Shift Track procedures.)

Press letter button next to RTK OPERATING MODE and toggle to QUICK SURVEY BASE MODE.

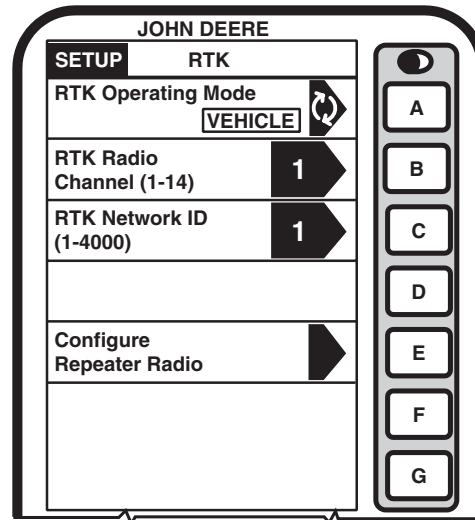

SETUP - RTK

- A—RTK Operating Mode
- B—RTK Radio Channel
- C—RTK Network ID
- D—
- E—Configure Repeater Radio
- F—
- G—

PC9578 -UN-06NOV06

OUC6050,0000C3E -19-17OCT07-1/1

Absolute Mode

IMPORTANT: Absolute Base Mode requires base receiver to be mounted in a rigid position. Tripod is not recommended.

NOTE: Display is not required after base station receiver has been configured to operate in Absolute Survey Base Mode and RTK Radio Channel/Network ID have been set.

Connect display to base station.

Screen: SETUP - RTK

Press: SETUP >> STARFIRE RECEIVER >> DIFF CORRECTION SETUP >> RTK SETUP

Press letter button next to RTK OPERATING MODE and toggle to ABSOLUTE SURVEY BASE MODE.

- A—RTK Operating Mode
- B—RTK Radio Channel
- C—RTK Network ID
- D—Configure Repeater Radio
- E—Edit Stored RTK Base Locations
- F—
- G—

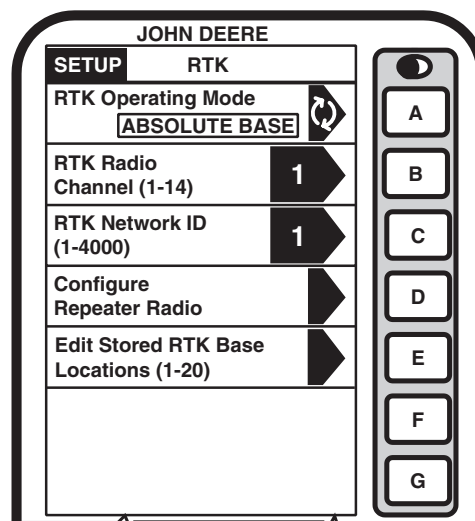

SETUP - RTK

PC9579 -UN-06NOV06

Continued on next page

OUC6050,000226E -19-14NOV06-1/4

Press letter button next to EDIT STORED RTK BASE LOCATION (1-20) and SETUP - RTK screen will be displayed.

NOTE: Enter unique location number each time base station is moved to new mounting location (i.e. location 1 = West 40, Field location 2 = North 80, Field location 3 = Farm shop).

Press letter button next to EDIT STORED RTK BASE LOCATION (1-20) and enter desired location number.

- A—Edit Stored RTK Base Locations
- B—Base Latitude
- C—Base Longitude
- D—Base Altitude
- E—CLR for Negative
- F—Survey RTK Base Location
- G—Return to GPS Setup

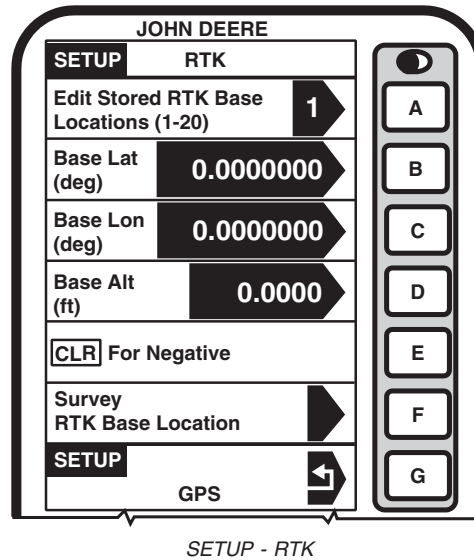

PC9580 -UN-06NOV06

OUO6050,000226E -19-14NOV06-2/4

Not known coordinates: Press letter button next to SURVEY RTK BASE LOCATION.

- A—Edit Stored RTK Base Locations
- B—Base Latitude
- C—Base Longitude
- D—Base Altitude
- E—CLR for Negative
- F—Survey RTK Base Location
- G—Return to GPS Setup

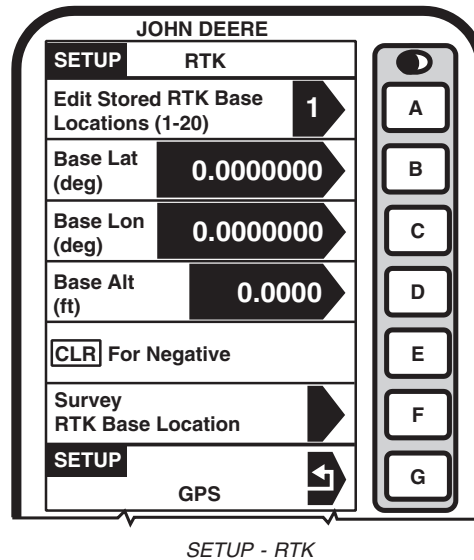

PC9580 -UN-06NOV06

Continued on next page

OUO6050,000226E -19-14NOV06-3/4

NOTE: After (24 hour) self survey is complete, base station coordinates will automatically be stored and associated with base location number (1-20). Verify base station coordinates, see RTK INFO Pages.

Press letter button next to START SELF SURVEY.
Display can be removed while survey is in progress.

After 24 hour survey is complete, base station will automatically store surveyed coordinates and begin transmitting corrections. Manually record coordinates and elevation and store in safe location. These coordinates may be used to enter previously surveyed base station location into different receiver.

NOTE: Absolute Base Mode, coordinates may be manually entered, if known from previous survey.

Known Location: Press letter button next to BASE (LATITUDE, LONGITUDE AND ALTITUDE) and enter values for;

- Base Lat (deg)
- Base Lon (deg)
- Base Alt (ft)

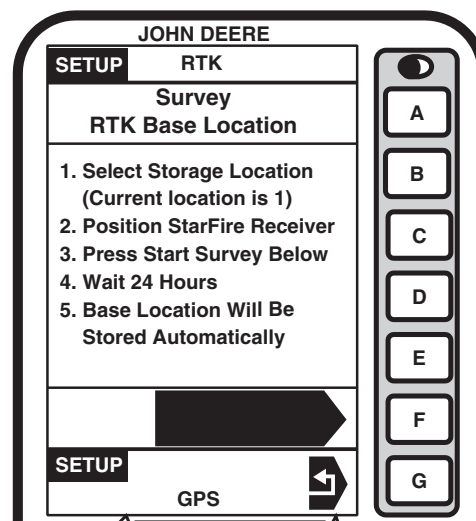

Setup - RTK

- A—Survey, RTK Base Location
- B—Locate Storage Location
- C—Position StarFire Receiver
Press Start Survey Below
- D—Wait 24 hours
- E—Base Location will be Stored Automatically
- F—Start Self Survey
- G—Return to GPS Setup

PC9581 -UN-06NOV06

Shared Base Station RTK Security

SBS RTK Security is security from unwanted users accessing a SBS RTK Network. This security feature keeps unauthorized RTK vehicles from accessing RTK corrections from the base station by granting access to only those RTK vehicles on an access list.

Compatibility

Base Station This security feature will only be available on StarFire iTC base stations. It will not work on original StarFire receivers being used as base stations. All setup has to be performed with an Original GreenStar Display.

RTK Vehicle It is compatible with original StarFire and StarFire iTC receivers being used as RTK vehicles. Setup can be performed with an Original GreenStar Display or a GSD 2100 or 2600.

Software Versions Original StarFire Receiver – requires software version of 7.50x or greater. StarFire iTC Receiver – requires software version of 2.50x or greater.

Theory of Operation

The SBS RTK Network operator will enter into the base station the serial numbers of RTK vehicle receivers that are allowed to access the RTK corrections from that base station. RTK vehicle serial numbers can be added and removed at any time with an original GreenStar Display. Only those rover serial numbers that are on the access list on the base station receiver will be allowed to access the RTK corrections from the base station.

Base Station Setup (Original GreenStar Display Only)

Screen: SETUP – RTK

Press: SETUP >> STARFIRE iTC >> DIFF CORRECTION SETUP >> RTK SETUP

NOTE: RTK base station must be operating in either Quick Survey Base or Absolute Base Mode.

Enter a RTK Network ID between 4001 – 4090 (secure Network ID range) in cell “C”.

RTK SECURE NETWORK will appear in cell “F”. Select letter button “F”

Entering RTK vehicle (rover) serial numbers

Press letter button next to ROVER # (1-99) and enter desired location number to store the RTK vehicle receiver serial number. There are 99 slots available.

Press letter button next to ROVER HARDWARE SN and enter serial number of RTK vehicle StarFire receiver.

NOTE: Original GreenStar Display - The six digit hardware serial number can be found on INFO – GPS – PAGE 3. Go to display in RTK vehicle: Press INFO >> STARFIRE iTC >> press PAGE button until you reach PAGE 3.

NOTE: GreenStar 2100/2600 Display – The six digit hardware serial number can be found on STARFIRE iTC - ACTIVATIONS tab. Go to display in RTK vehicle: Press MENU >> STARFIRE iTC >> ACTIVATIONS tab.

Rover Access List (RAL)

Screen: SETUP – RAL

Press: SETUP >> STARFIRE iTC >> DIFF CORRECTION SETUP >> RTK SETUP >> RTK SECURE NETWORK >> DISPLAY AUTHORIZED LIST.

This displays the RTK vehicle receiver serial number and location it is stored. Only the serial numbers on the RAL will be able to receive RTK corrections from the base station when RTK Network is in SECURE mode (see Security Mode section below).

Press PAGE button to view subsequent pages of the RAL.

RTK Network Operating Mode

Screen: SETUP - RTK

Press: SETUP >> STARFIRE iTC >> DIFF CORRECTION SETUP >> RTK SETUP >> RTK SECURE NETWORK >> RTK NETWORK IS CURRENTLY.

SBS Security can be operated in a Public or Secure mode.

- Public – This mode does not restrict RTK vehicles from receiving RTK corrections as long as they have the same Network ID as the base station. This mode can be used when conducting a RTK demo for potential customers or field days.
- Secure – This mode restricts RTK vehicles from receiving RTK corrections if their serial numbers are not entered into the RAL

Deleting RAL

Screen: SETUP – RTK

Press: SETUP >> STARFIRE iTC >> DIFF CORRECTION SETUP >> RTK SETUP >> RTK SECURE NETWORK >> DELETE ENTIRE LIST

RTK vehicle serial numbers can be deleted individually or the entire list can be deleted.

Deleting individual entries:

Press letter button next to ROVER # (1-99). Enter the vehicle receiver stored number that will be deleted (1-99).

Press letter button next to ROVER HARDWARE SN. Enter a non-zero number (example: "1") in place of the serial number. The serial number has been removed from the RAL.

NOTE: Once a RTK vehicle serial number has been deleted from the RAL, it will take approximately 18 minutes before the RTK vehicle will not longer be able to operate off of that base station. During this time the vehicle will transition into RTK extend.

Deleting entire list

Press letter button next to DELETE ENTIRE LIST.

Press letter button next to SUBMIT. It will change to DELETED once the RAL has been deleted.

*NOTE: Verify RAL has been deleted by viewing RAL list
(See Rover Access List section above).*

RTK Vehicle Setup

Original GreenStar Display

Screen: SETUP – RTK StarFire iTC

Press: SETUP >> STARFIRE iTC >> DIFF
CORRECTION SETUP >> RTK SETUP >> VEHICLE

Original StarFire

Press: SETUP >> STARFIRE RECEIVER >> DIFF
CORRECTION SETUP >> RTK SETUP >> VEHICLE

*NOTE: RTK vehicle can be operated in either Vehicle or
Vehicle Repeater Mode.*

Enter the same RTK Network ID that the base station is
configured too.

RTK Vehicle Security Status

The RTK Vehicle (when operating off of a Secure Network
ID) will exist in one of the three following RTK
authorization states: Unknown, Authorized, or Not
Authorized.

These states are displayed in one or more of the following
locations depending on display and receiver used:
(Displayed on INFO – GPS – PAGE 3 (StarFire iTC) or
PAGE 5 (Original StarFire) or Cell G on GSD or on Cell G
of the Original GreenStar Monitor on a GS2 display).

Unknown – The RTK Vehicle StarFire upon power up is
in an “unknown” RTK authorization state. It will exist in
this state until communication with the base station is
established. No message will be displayed in cell G of the
GreenStar Display.

Authorized – On power-up of a RTK Vehicle StarFire that
is properly configured and on the authorization list , the
message “RTK Network: Authorized” will be displayed in
cell G as soon as it establishes communication with the
secure RTK base station and it determines that it is
authorized to receive RTK corrections.

Unauthorized – On power-up of a RTK Vehicle StarFire that is properly configured, but the serial number has not been entered into the base station RAL, the message “RTK Network: Not Authorized” will be displayed in cell G as soon as it establishes communication with the secure RTK base station and it determines that it is not authorized to receiver RTK corrections.

OUC6050,0000C40 –19–23SEP07–5/5

Time Slot

NOTE: 10 time slots are available. The default time slot is 1.

Check that base station, vehicle, and repeater have same Frequency, Network ID and Time Slot.

Screen: SETUP - RTK

Press: SETUP >> STARFIRE RECEIVER >> DIFF CORRECTION SETUP >> RTK SETUP

The time slot may be changed if other RTK systems are operating in area and interference is causing decreased base station communication performance.

- A—RTK Operating Mode
- B—RTK Time Slot
- C—RTK Network ID
- D—
- E—Radio and Repeater Configuration
- F—
- G—Return to Differential Corrections Setup

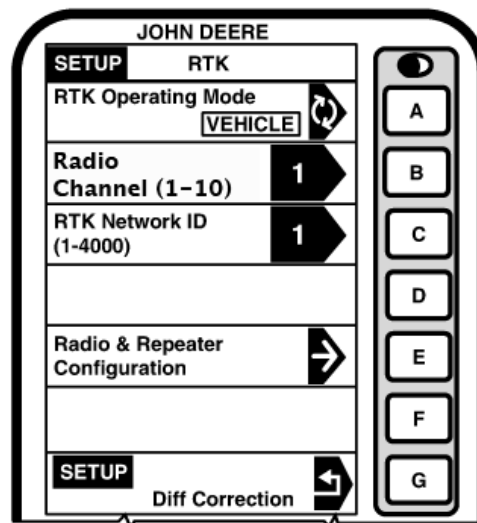

PC8736 –UN–17OCT07

OUC6050,0000C41 –19–06NOV07–1/1

Network ID

NOTE: 4000 network ID's are available, default ID is 1.

Check that base station, vehicle, and repeater have same Frequency, Network ID and Time Slot.

Screen: SETUP - RTK

Press: SETUP >> STARFIRE RECEIVER >> DIFF CORRECTION SETUP >> RTK SETUP

Network ID for base station and vehicle receiver must match. If more than one base station with same Network ID numbers are within range, vehicle may lock on to either one of base stations. To prevent this from happening, be sure to use unique network ID.

- A—RTK Operating Mode
- B—RTK Time Slot
- C—RTK Network ID
- D—
- E—Radio and Repeater Configuration
- F—
- G—Return to Differential Corrections Setup

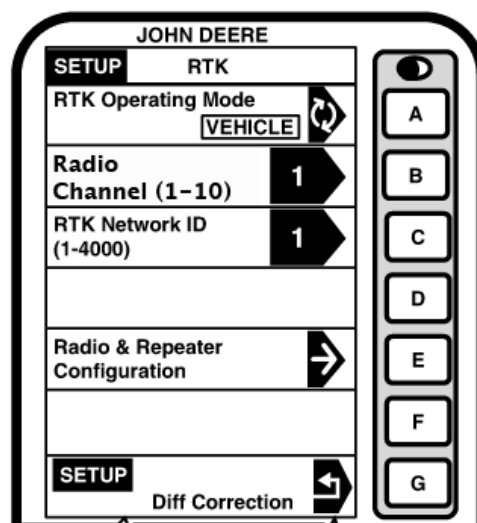

SETUP - RTK

PC9736 -UN-17OCT07

OUC6050,0000C42 -19-18OCT07-1/1

Repeater

NOTE: The radio can be configured to act separately as repeater. A repeater is required if obstructions (i.e. trees, hills, etc.) exist between base station and vehicle(s).

A repeater consists of:

- Radio (configured as a repeater)
- Harness
- Mounting Bracket
- 12 Volt Power Source

To configure radio as repeater:

Screen: SETUP - RTK

Press: SETUP >> STARFIRE RECEIVER >> DIFF CORRECTION SETUP >> RTK SETUP

1. Connect radio to receiver RTK harness.
2. Check that receiver has GPS position calculated.
3. Check that base station, vehicle, and repeater have same Frequency, Network ID and Time Slot.
4. Press letter button next to CONFIGURE REPEATER RADIO.
5. Radio will configure as repeater.
6. Disconnect repeater from receiver and wiring harness.
7. Reconnect original radio.

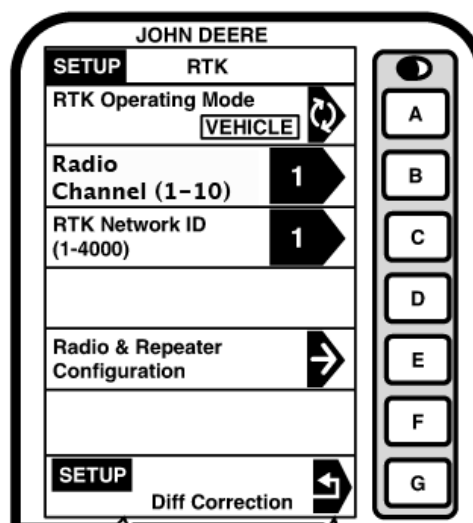

SETUP - RTK

- A—RTK Operating Mode
- B—RTK Time Slot
- C—RTK Network ID
- D—
- E—Radio and Repeater Configuration
- F—
- G—Return to Differential Corrections Setup

PC9736 -UN-17OCT07

OUO6050.0002272 -19-25NOV06-1/1

Operating Vehicle

IMPORTANT: The base station receiver and vehicle receiver must be setup before operating RTK. See Setup sections for setup procedures.

When vehicle receiver is powered-up, No GPS, No Diff will be displayed on RUN - TRACKING - PAGE screen until an initial position is determined. When base station transmits correction signal, 3D RTK will be displayed on RUN - TRACKING - PAGE screen.

- A—
- B—
- C—
- D—
- E—Track Number, Error
- F—
- G—3D RTK, Shift Track, Mark Point

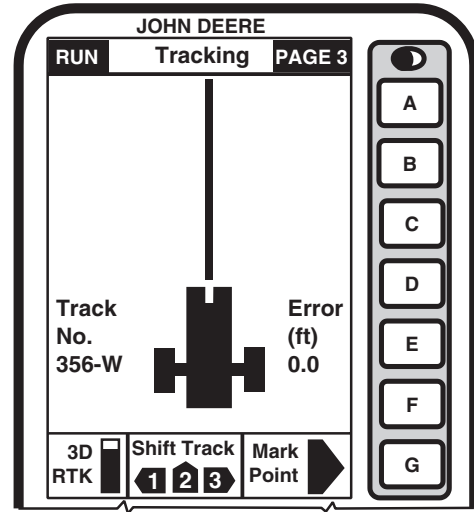

RUN - Tracking - PAGE 3

PC9562 -UN-06NOV06

Continued on next page

OUC6050,0000C44 -19-17OCT07-1/2

NOTE: If communication loss is *WITHIN* first hour of base station operation, Extend Mode will provide RTK accuracy for two minutes.

Communication loss *AFTER* first hour of base station operation, Extend Mode will provide RTK accuracy for 15 minutes.

Extend Mode (RTK-X): If communication between base station and vehicle radio is lost for more than 10 seconds, vehicle receiver will automatically switch to Extend Mode and will maintain RTK accuracy for a period of time. If base station has been powered for less than one hour, Extend Mode will be available for 2 minutes. If base station receiver has been powered for more than one hour, 15 minutes of Extend Mode will be available. If base station communication is not re-established after Extend period, receiver will default to EGNOS, or NO DIFF where EGNOS is not available.

NOTE: Check that base station, vehicle, and repeater have same Frequency, Network ID and Time Slot.

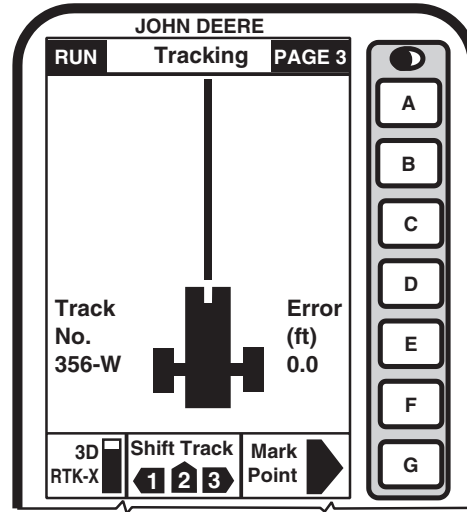

RUN - Tracking - PAGE 3

- A—
- B—
- C—
- D—
- E—Track Number, Error
- F—
- G—3D RTK, Shift Track, Mark Point

PC9565 -UN-06NOV06

OUO6050,0000C44 -19-17OCT07-2/2

INFO Pages, Base Station

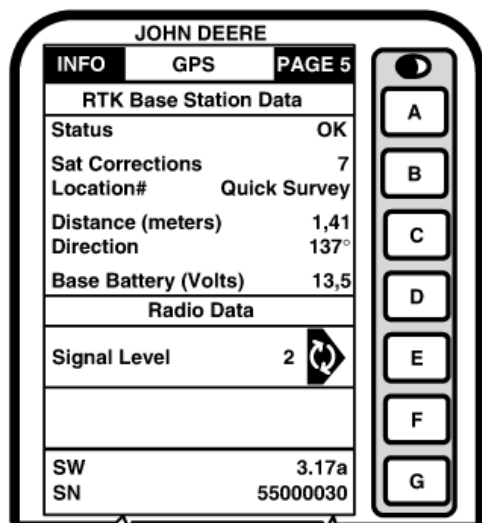

Quick Survey

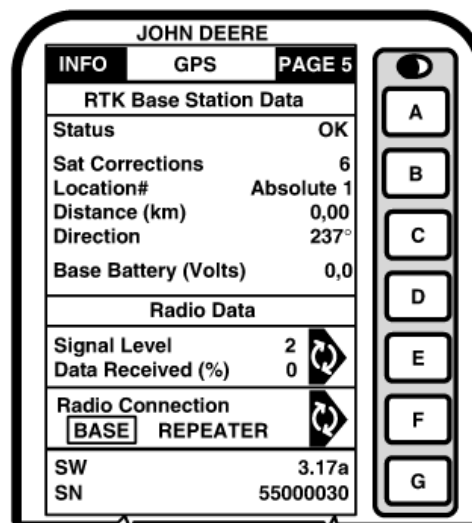

Absolute Survey

A—RTK Base Station Data Status
B—Satellite Corrections Location Number

C—Distance Direction
D—Base Battery
Radio Data

E—Signal Level Data Received
F—Radio Connection

G—Software Version Serial Number

Screen: INFO - GPS - PAGE 5

This screen allows operator to view:

- **Status**
 - OK - Base Station is transmitting correction.
 - No Stored Base - 24 hour self survey is required for current location.
 - Initializing - Receiver is initializing radio, acquiring GPS signal.
 - Self Survey - 24 hour self survey in progress.
- **Sat Corrections** - Indicates number of GPS satellites for which base station is transmitting correction.
- **Distance** - Difference between base station location (known position) and location indicated by uncorrected GPS.
- **Direction** - Direction from base station location (known position) to location indicated by uncorrected GPS.
- **Base Battery (volts)** - Base Station voltage.

- **Signal Level** - Level of signal that is detected at radio. The signal level will range from 0 to 100 (-180 dBm to -80 dBm or above). Press E button to refresh signal level.

NOTE: For Data Received (%): Value less than 100 % indicates an obstruction between base station radio and vehicle radio.

If percent of received correction is 0, and signal level is high, check for potential radio interference sources such as two-way radios, radio towers, etc.

- **Data Received (%)** - Percent of received correction to base station from vehicle.
- **Radio Connection** - Indicates source of correction. If there is no connection, this will toggle between base and repeater.
- **SW** - Version of radio software
- **SN** - Serial number of radio connected to receiver.

INFO Pages, Vehicle

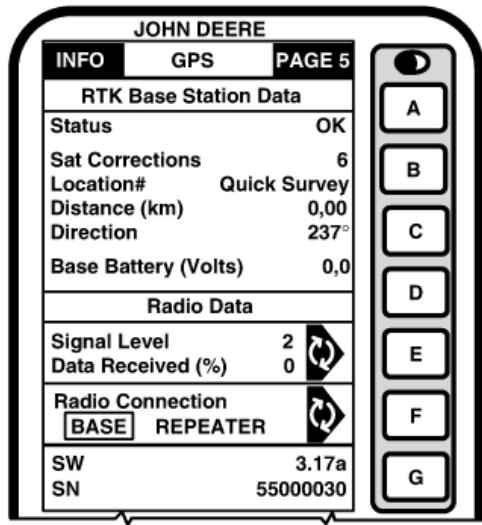

PC9739 -UN-19NOV06

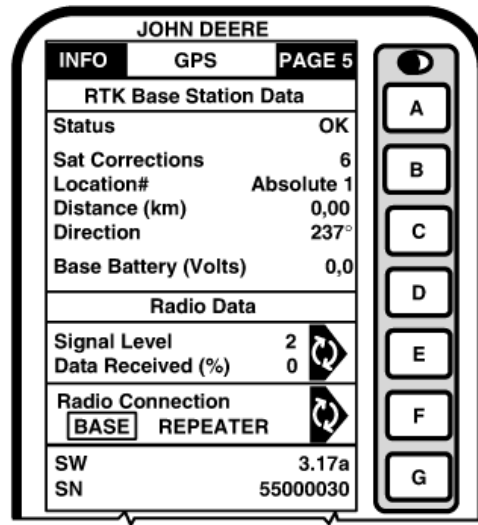

PC9738 -UN-19NOV06

Absolute Survey

- A—RTK Base Station Data Status
- B—Satellite Corrections Location Number
- C—Distance Direction
- D—Base Battery
- E—Signal Level Data Received
- F—Radio Connection
- G—Software Version Serial Number

Screen: INFO - GPS - PAGE 5

This screen allows operator to view:

- **Status**
 - OK - Base Station is transmitting correction.
 - No Stored Base - 24 hour self survey is required for current location.
 - Initializing - Receiver is initializing radio, acquiring GPS signal.
 - Self Survey - 24 hour self survey in progress at base station.
 - No Signal - Vehicle radio is not receiving signal from base station.
- **Sat Corrections** - Indicates number of GPS satellites for which base station is transmitting correction.
- **Distance** - Distance from base station to vehicle receiver.
- **Direction** - Direction in degrees to base station.
- **Base Battery (volts)** - Base Station voltage.
- **Signal Level** - Level of signal that is detected at radio. The signal level will range from 0 to 100 (-118

dBm to -55 dBm. Values greater than -55 dBm are reported as 100.). Press E button to refresh signal level.

NOTE: For Data Received (%): Value less than 100 % indicates an obstruction between base station radio and vehicle radio.

If percent of received correction is 0, and signal level is high, check for potential radio interference sources such as two-way radios, radio towers, etc.

If percent of received correction is 0, and signal level is low, check for potential obstructions of line of sight conditions such as hills, buildings, trees, etc.

- **Data Received (%)** - Percent of received correction to vehicle from base station.
- **Radio Connection** - Indicates source of correction. If there is no connection, this will toggle between base and repeater.

Continued on next page

OUC6050,0000C46 -19-08NOV07-1/2

Original GreenStar Display—RTK

- **SW** - Version of radio software.

- **SN** - Serial number of radio connected to receiver.

OJ06050,0000C46 -19-08NOV07-2/2

RTK Base Station Setup

Country Use Restrictions

The John Deere SF 869 MHz RTK Radio Modem is designed to operate on frequency ranges, the exact use of which differs from one region and/or country to another. The user of the radio modem must take care that the said device is not operated without permission of the local authorities on frequencies other than those specifically reserved and intended for use without a specific permit. The John Deere SF 869 MHz RTK Radio Modem is designed to operate in the following countries listed below on the license free frequency band of 869.400 – 869.650 MHz (not incorporating the band 869.300 – 869.400 MHz) according to recommendation CEPT/ERC/REC 70-03. This recommendation has been drawn up by the European Radio communications Committee (ERC) under CEPT.

NOTE: The CEPT regulates effectively radiated power output (ERP) from the radio at 27 dBm (=500 mW). The usage of an antenna other than the one supplied might lead to violation of the above license free regulation.

Countries:

- Austria, AT
- Belgium, BE
- Czech Republic, CZ
- Estonia, EE
- Finland, FI
- France, FR

- Germany, DE
- Hungary, HU
- Iceland, IS
- Ireland, IE
- Luxembourg, LU
- Malta, MT
- Netherlands, NL
- Norway, NO
- Portugal, PT
- Slovakia, SK
- Slovenia, SI
- Spain, ES
- Sweden, SE
- Switzerland, CH
- United Kingdom, GB

IMPORTANT: Please contact your local radio authorities for country specific regulations and licensing

NOTE: Codes of the countries follow the ISO 3166-1 Alpha-2 standard

For Portugal, Italy and Lithuania a licence is required.

For Lithuania, the power is limited to 5 mW.

For Poland the frequencies are not allowed.

OUO6050.0002353 -19-19NOV06-1/1

System Overview

The StarFire™ RTK system consists of a local base station placed in a field or mounted on a structure that transmits high accuracy corrections to the vehicle StarFire™ receiver using RTK radios. The StarFire™ receiver on the RTK-equipped vehicle must have a direct line of sight with the base station in order to receive the RTK signal.

Performance of the RTK system is related to the operating distance from the base station. When operating beyond 20 km (12 miles), degraded accuracy will occur and it may take longer to initially acquire the RTK signal.

A repeater, which is simply an RTK radio supplied with 12 volts of power, can be used to receive the base station signal and establish a new line of sight point. However, performance limitations can still be expected if trying to use the repeater to transmit the RTK signal to a vehicle that is farther than 20 km (12 miles) away from the base station.

OJ06050,0000EDA -19-08NOV07-1/4

Receiver—On Vehicle

Position receiver with integrated RTK radio module is located on top of machine. Position receiver receives global positioning and differential correction signal through a single receiver and integrates signal for use with system.

The receiver has a dedicated operating mode (Vehicle Mode). Refer to “Operating Mode—RTK” in “StarFire iTC” Section for setup of the receiver on vehicle.

IMPORTANT: The antenna must be installed before the radio module is powered ON.

Avoid water intrusion by keeping the antenna attached whenever possible.

Removing the antenna while transmitting may damage the radio module.



ZX1038873

ZX1038873 -UN-06FEB06

Continued on next page

OJ06050,0000EDA -19-08NOV07-2/4

Receiver—On Base Station

The base station is the most critical part of an RTK system. During installation, care must be taken to ensure the base has problem-free operation. There are two issues that are responsible for most problems with a base station: **Shading and Multipathing**. If a base station experiences one of these problems, it could be detrimental to your RTK operation. Although it may not be possible to locate a base station in an ideal location, this guide is aimed at helping to define the best option available.

Base station operating mode can be either Absolute Survey Base Mode or Quick survey Base Mode. Refer to “Operating Mode—RTK” in “StarFire iTC” Section for setup of the receiver on base station.

Refer to “Base Station Operation and Setup” in “StarFire iTC” Section for proper use and setup of the base station.



OUO6050,0000EDA -19-08NOV07-3/4

Repeater Radio

The radio can be configured to act separately as a repeater. A repeater is required if obstructions (i.e. trees, hills, etc.) exist between the base station and vehicle(s) or if base station is too far away from the vehicles.

A repeater consists of:

- Radio (configured as a repeater)
- Harness
- Mounting Bracket
- 12 Volt Power Source
- Tripod or wall mount cradle

IMPORTANT: A repeater can only be used to repeat a signal from a base station to a vehicle. Therefore, a repeater cannot be used in a "daisy chain," repeating the signal from one repeater to another.

Refer to “Repeater—RTK” in “StarFire iTC” Section to properly configure radio as repeater.



OUO6050,0000EDA -19-08NOV07-4/4

Installation of the RTK radio and antenna

Once you have installed the base station receiver, installing the radio in a location to best maximize the output, can be a challenge. Below are four options currently available through John Deere.

- Leave the RTK radio in its original configuration attached directly behind the base station receiver.
- Use a repeater as part of the base station. Install a radio with the base station receiver. Then install a Repeater radio, available through whole goods or parts, in an elevated location. The base station will then send the RTK data to the repeater and the repeater will then transmit that data out to the vehicle on the network. This will eliminate other repeaters in the system.
- Use PF80821 extension harness (92 m; 300 foot in length), moving the radio from the back of the base station receiver to an elevated position, and running the harness in between.

NOTE: It is important to use the PF80821 harness and grounding wire properly according to the installation instructions. This harness has built in protection for both your radio and receiver for unwanted static electricity developed on the harness.

- Attach the RTK radio in a secured location and run coaxial cable between the radio and the antenna.

IMPORTANT: The antenna must be installed before the radio module is powered ON.

Avoid water intrusion by keeping the antenna attached whenever possible.

Removing the antenna while transmitting may damage the radio module.

IMPORTANT: If using a coaxial cable between the radio and the antenna, you need to use the lowest-loss cable available or you may suffer RTK radio link range issues.

NOTE: When using this option, it may be necessary to install a higher-gain antenna to compensate for loss.

Always mount the radio antenna vertically to make sure that the RTK signal is radiating outwards. If the antenna is at an angle, it may cause the data received at the vehicle to be lower than expected.

Attaching RTK Harness



PC8570 -UN-14JUL05

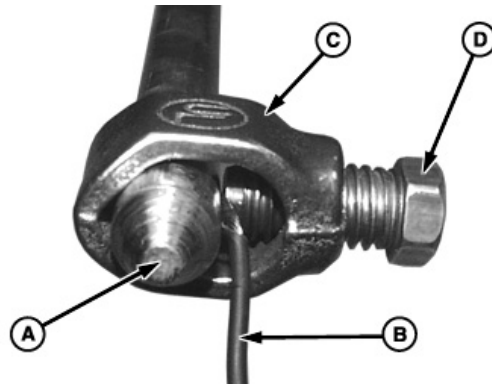

PC8568 -UN-14JUL05

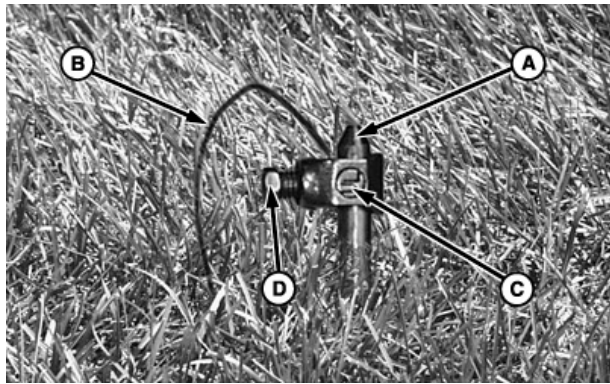

PC8571 -UN-14JUL05

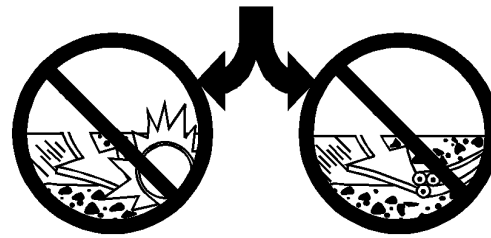

PC8569 -UN-14JUL05

A—Rod

B—Grounding Wire

C—Collar

D—Screw

CAUTION: Avoid serious injury or death to you or others. Contact your local utility companies to determine the location of gas, electric, or water lines. Placement of grounding rod must be a safe distance away from pipelines and cables.

IMPORTANT: Carefully choose location of rod so that it is away from paths where it could damage equipment or be damaged by equipment.

DO NOT route RTK Extension harness along any other power sources. Keep harness at least 2m (6 ft) away from any other AC power lines.

1. Attach harness between radio and receiver.

2. Carefully determine placement of rod (A) a safe distance away from pipelines and cables. Drive into ground leaving one end above surface.
3. Route grounding wire (B) from harness to rod. Grounding wire may be extended if necessary to reach rod.
4. Remove insulation from end of grounding wire.
5. Place collar (C) over end of rod.
6. Place grounding wire between rod and screw (D).
7. Tighten screw.
8. Restrain harness to supporting structures as necessary to keep them away from equipment, damage, and to reduce wire strain.

RTK Network Base Station Setup



A—7° Off the Horizon (Mask)

Installing and operation of the Base Station Receiver.

The base station is the most critical part of the RTK operation, so setting up a base station correctly is vital to the operation of the RTK system. If the Base Station Receiver is setup in a questionable location, the receiver could have two separate issues; Shading and Multipathing

Shading:

In order to insure proper operation of a RTK base station, the GPS Receiver must have a clear view of

the sky in all directions above 7 degrees off the horizon. Both the base receiver and the vehicle receiver will use any satellites that are above 7 degrees off the horizon. If a base station receiver can't use a satellite above 7 degrees, then all vehicles operating on that base station also can't use that blocked satellite. This is call "Shading" of the base station. If enough of this occurs your RTK system could be inaccurate. Many things can cause shading such as buildings, towers, poles and grain legs.

Continued on next page

OUC6050,0002276 -19-14NOV06-1/4

PC8734 -JUN-01SEP05

RTK Base Station Setup



A—Receiver

NOTE: The closer the receiver is to the tower, the more it will be shaded.

In the pictures above, the base stations are shaded by the surrounding objects.

Picture on the left—the towers in the background and the pole behind the receiver will block GPS satellites as they pass behind it.

Picture on the right—the base station will be shaded by both the grain tubes and bins on the right.

Continued on next page

OUC6050.0002276 -19-14NOV06-2/4

RTK Base Station Setup



PC8736 -UN-01SEP05

A—Receiver

This receiver could be affected by both Multipathing and by shading. All the grain legs in the picture will shade the receiver from satellites.

Continued on next page

OOU6050,0002276 -19-14NOV06-3/4

RTK Base Station Setup



A—Receiver

In the pictures above, both receivers will experience shading.

Picture on the left—Shaded by the tower

Picture on the right—Shaded by the pole.

The receiver on the right will have more shading issues than the receiver on the left because the pole is right up against the receiver shading a large portion of the sky. The receiver on the left has been moved further away from the tower to reduce shading issues.

OUO6050,0002276 -19-14NOV06-4/4

Multipathing

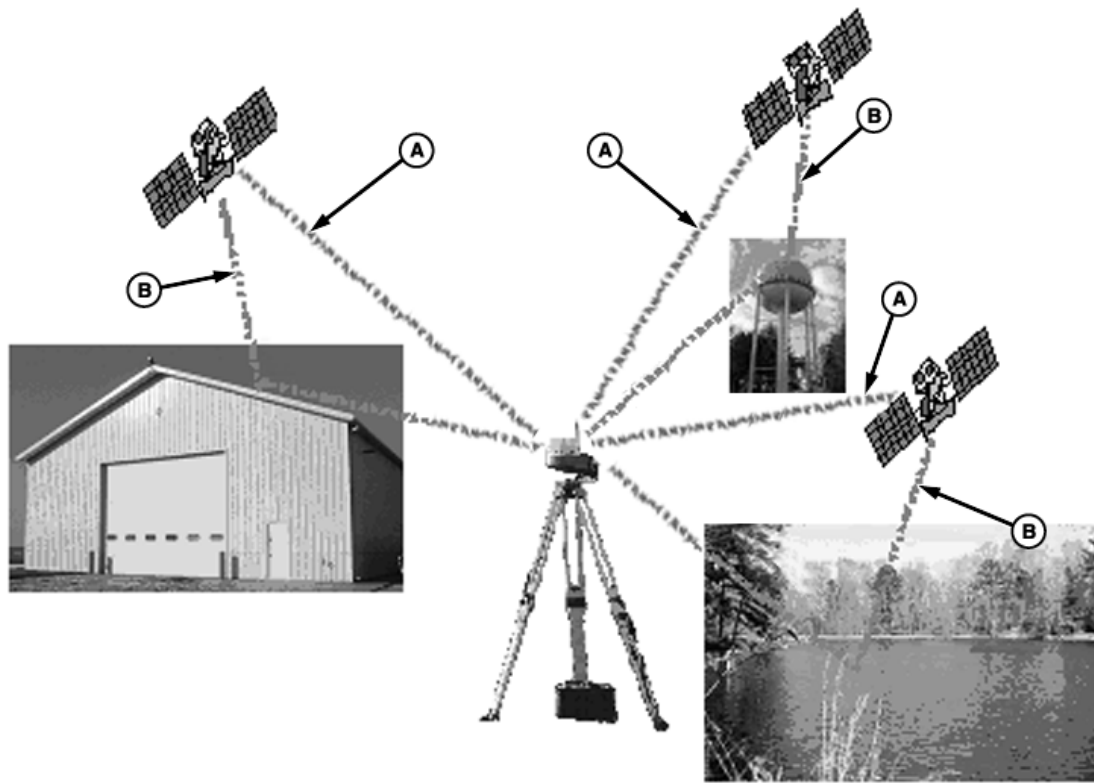

PC8738 -UN-13SEP05

A—Good Sources

B—Multipath Sources

Before explaining how to protect against Multipathing, let's discuss exactly what Multipathing is: Each satellite sends down time coded messages for any receiver to pick up. If a receiver sees multiple time coded messages from the same satellite, it determines there is a problem with the satellite and discontinues using that satellite until it determines the problem is corrected. This could take up to minutes before the situation corrects itself. The following are some examples of what causes multipath.

- Metal roofs
- Center pivots

- Water towers
- Pickup trucks
- Grain bins
- Bodies of water

In the following pictures, we have provided illustrations to help show how Multipathing occurs. The time coded signal from the GPS satellite is being beamed down in all directions, so if the same time coded signal is reflected off of an object back towards a receiver, the receiver will see the same message many times. If this occurs, you could see A/B line jumps while operating in the field

Continued on next page

OUC6050,0002277 -19-27NOV06-1/6

RTK Base Station Setup



Even though the multipath signal may be reflected in below the 7 degree elevation mask, the receiver may still use this message because the time coded message tell the receiver that the satellite position is above 7 degrees (i.e. Sat 1; Elev. 35 degrees, Azimuth 255 degrees).



Both the roof of the car and the building are causing multipath to occur at the base station receiver. The signals is bounce along the car or building and enter the receiver at a slight delay from when the direct satellite message is received.

Continued on next page

OOU6050.0002277 -19-27NOV06-2/6

RTK Base Station Setup

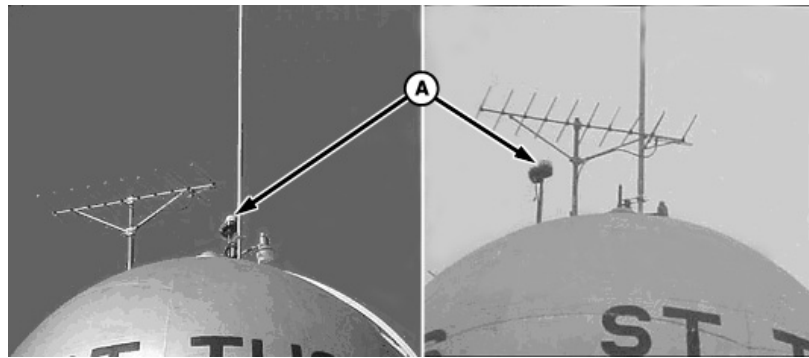

A—Receiver

Picture on the Left: The base station, with receiver attached 1 foot off the top of the tower, was being affected by multipath from the dome of the water tower. The vehicle receiver running off this base station experienced different symptoms:

- Two vehicles would be operating at the same time. One vehicle would go from RTK into RTK-X and see a line jump of up to 6 inches for a couple of minutes, while the other vehicle would be operating without incident.
- At a later time, the situation would reverse, and the vehicle without incident earlier would go into RTK-X

and experience a line jump, while the other vehicle wouldn't.

The reason the vehicles behaved differently was because each vehicle may have been using a different set of satellites at a given time due to shading and vehicle location.

Picture on the Right: Base station was elevated 5 feet off the top of the tower. Raising the receiver greatly reduced the multipath effects observed on this RTK system.

Continued on next page

OOU6050,0002277 -19-27NOV06-3/6

RTK Base Station Setup

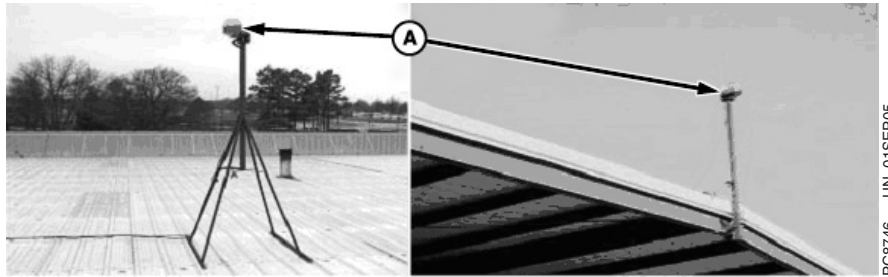

A—Receiver

To reduce both multipathing and shading, elevate the base station receiver above any structure to which it is attached. For best results, two meters or more from the highest point of the structure is recommended. The higher the better, but you must also ensure that the base station receiver is attached solidly so there is no movement of the receiver. Movement of the base

station receiver will result in the same movement in your vehicle. The two base stations shown above are examples of good base station locations, because the trees are below the 7 degrees elevation mask and the roof is not made of metal which helps to reduce multipathing.

Continued on next page

OOU6050.0002277 -19-27NOV06-4/6

RTK Base Station Setup

When setting up a tower network, ensure that the receiver (A) is 9.1 m (30 ft) away from the base of the tower (B) to protect your system from multipath.

A—Receiver
B—Tower

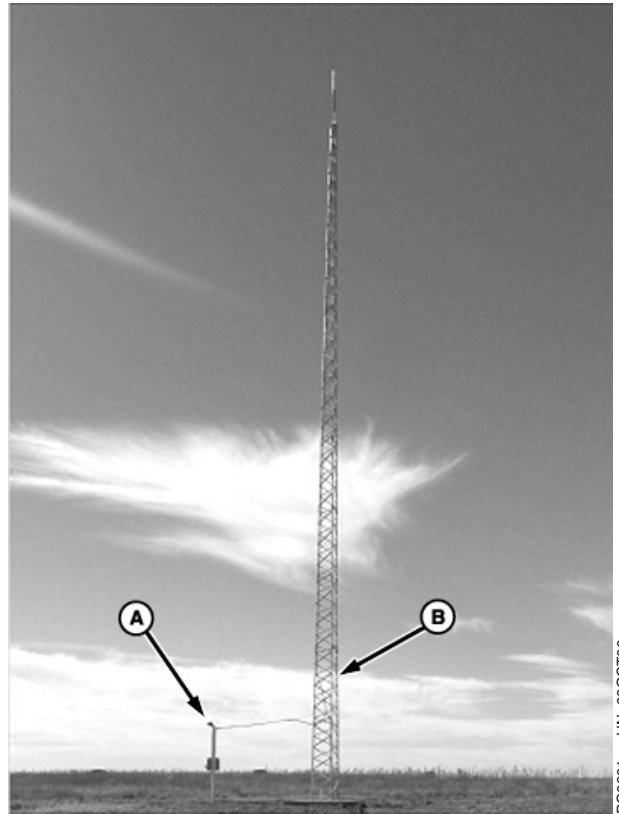

PC93891 -JUN-23OCT06

Continued on next page

OOU6050,0002277 -19-27NOV06-5/6

RTK Base Station Setup

When installing a receiver (A) on a shed, grain leg, water tower, or other tall structure, ensure the receiver is 2 m (6 ft) above the peak of the structure. This placement will help prevent multipathing of the receiver.

A—Receiver



PC9392 -UN-23OCT06

OOU6050.0002277 -19-27NOV06-6/6

RTK using Straight, Curves or Circle

RTK Base Station Network Areas Utilizing Straight, Curves or Circle AutoTrac

Symptoms:

- Customer changes base stations and/or fields and the vehicle does not align to the previous track or bed.
- Customer utilizes multiple base stations for the same field and does not see the desired AB line repeatability among vehicles or field passes.

NOTE: When the term AB line is used, it also encompasses Circle track and Curve track lines.

Solution:

RTK is designed to provide repeatability pass after pass and from season to season. This repeatability is a function of the Base Station location and it's correlation to a field specific AB line driven by the vehicle.

AB lines and field operations must be linked to the specific base station that they were originally created with. Every AB line in the field is created while utilizing a specific RTK base station. Every pass in that field for a particular season or set of beds must utilize the same original base station and location that was used to create that specific AB line(s).

OUC6050,0002278 -19-25NOV06-1/1

Example A

As you see in the picture, Field A (A) has 3 base stations located within a 9.7 km (6 miles) radius of the field. Although 3 base stations could be used to operate vehicles within this field, one base station must be selected to perform all field operations for that season and assigned/created AB lines. In this instance, the customer selected base station # 1 as it was centrally located to other farms.

This means that when AB lines are being created, all vehicles and operations for that cropping season **MUST** use the same base station and location. Also, if AB lines were set up during subsequent seasons, the same original base station that was utilized in subsequent seasons must be used again at the same base location.

AB lines must be assigned and associated to a specific base station in order to achieve absolute accuracy and repeatability. This absolute accuracy and repeatability is obtained during the base stations 24 hour absolute survey.

Any time a base station is used to perform a field operation and it **IS NOT** the base station that was used to create that original AB line, errors will exist in the AB line position. These errors will vary from location to location, but may be as much as 3 to 5 inches off.

A recommended practice is to assign every field to a specific base station. This will ensure that every operation performed in that field, including AB line creation, is utilizing the most accurate and repeatable correction signal possible.

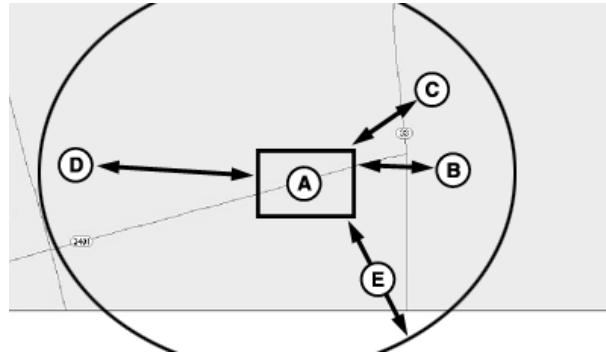

- A—Field A
- B—Base Station 1 — 6.4 km (4 miles)
- C—Base Station 2 — 4.8 km (3 miles)
- D—Base Station 3 — 4.8 km (3 miles)
- E—9.7 km (6 miles) radius

PC9394 -UN-30OCT06

Operating Parameters

StarFire iTC or Gen II Receiver Operating Parameters for ALL AutoTrac, SF1, SF2, and RTK

Several factors can attribute to a less than optimal performance of the GPS receiver, whether it is operating in SF1, SF2 or RTK mode. Any lack of performance while operating in RTK mode will display symptoms sooner than operating with SF1 and SF2. RTK operations require higher precision and many applications are in preexisting tracks, so the operator will notice unsatisfactory performance sooner by visually comparing against the previous tracks.

When operating with RTK, there are always 2 critical components that come into play:

1. Base Station Setup and any possible obstructions
2. Vehicle Setup and any possible obstructions

RTK vehicle operation is directly affected by the quality of the base station location and setup, not just vehicle GPS receiver interferences. The base station is feeding satellite correction information to the vehicle (rovers) at all times. If any of the GPS signals being received at the base station are distorted or corrupted in any way, that incorrect information will in turn be fed directly to the vehicle (rover) leading to a loss in accuracy and repeatability.

PDOP Definition

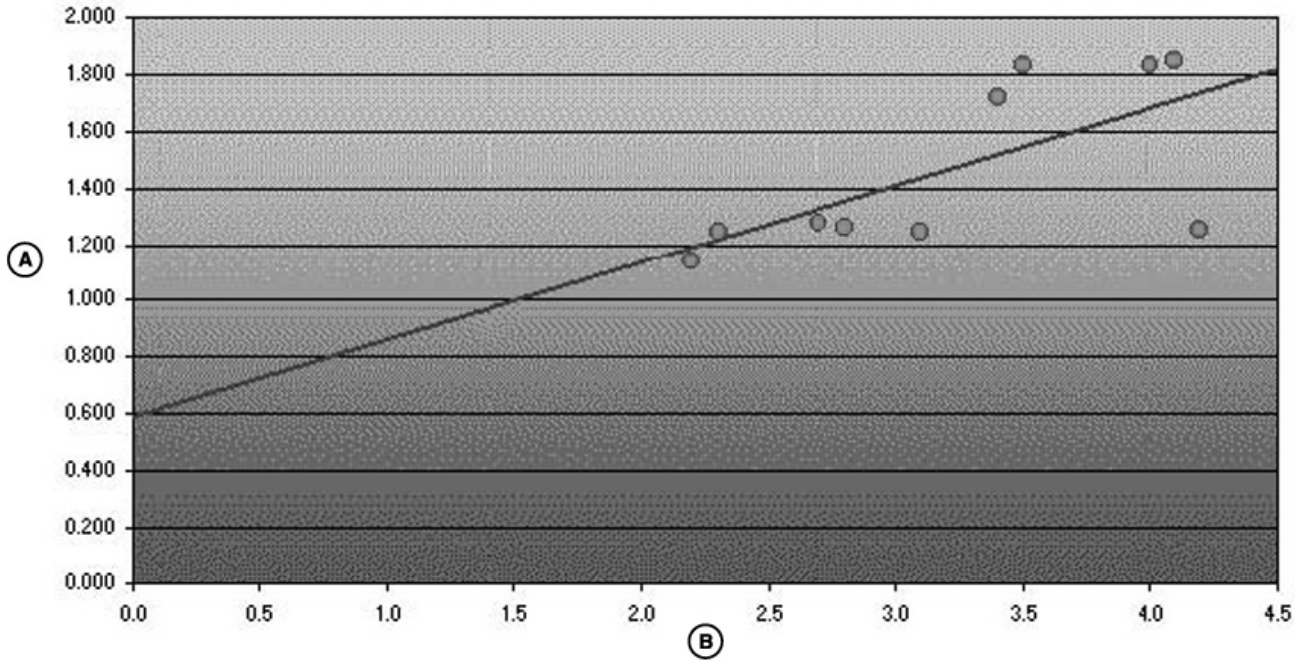

A—Horizontal Precision (m)

B—Maximum PDOP Value

The Position Dilution of Precision (PDOP) is likely one of the most critical GPS AutoTrac values to monitor. As the PDOP value increases, both the horizontal and vertical precision (guidance accuracy) of your data points decreases.

To help illustrate this relationship, please review the graph, which plots the PDOP value against the horizontal precision points collected on and around the University of Montana campus. Ten locations were collected to serve as ground control points to register

an April 4, 1999 aerial photograph of the University area. You can see that as the PDOP value climbs from a minimum of 1.15 to a maximum of approximately 4.5, the horizontal precision and accuracy decreases from about 1.15 meters to about 1.9 meters. PDOP values below 7 are generally required to collect data at a 1 meter accuracy range (as determined by the PDOP mask set on your data logger) and any value below 3.5 is considered in-range for AutoTrac applications.

Continued on next page

OOU6050,000227B -19-14NOV06-1/2

RTK Base Station Setup

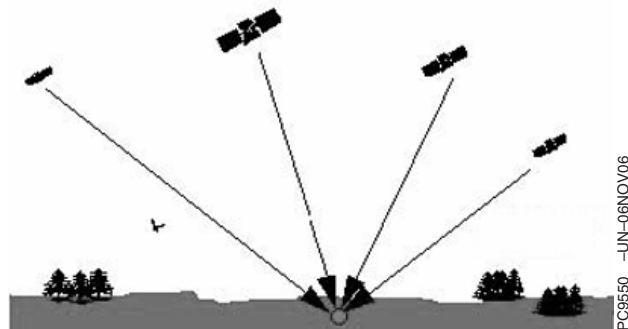

GOOD

Keep in mind that PDOP (Position Dilution of Precision) is the measure of the geometrical strength of the GPS satellite configuration. As a general rule, any PDOP value below 3.5 is acceptable to use while operating AutoTrac but, the lower the number, the more precise the steering accuracy will be.

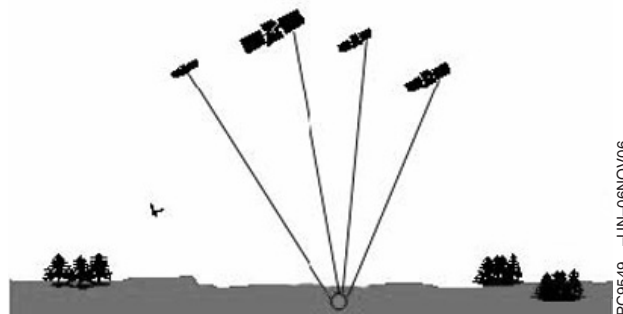

BAD

During vehicle operation, the PDOP can be viewed under the StarFire information pages in both the Original GreenStar Display and GS2 Display

OOU6050,000227B -19-14NOV06-2/2

PDOP Operating Values

StarFire iTC - Satellites

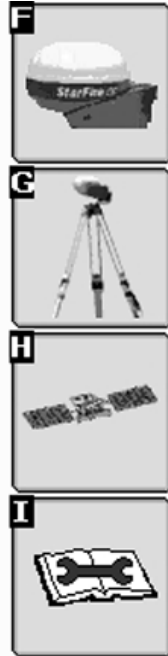
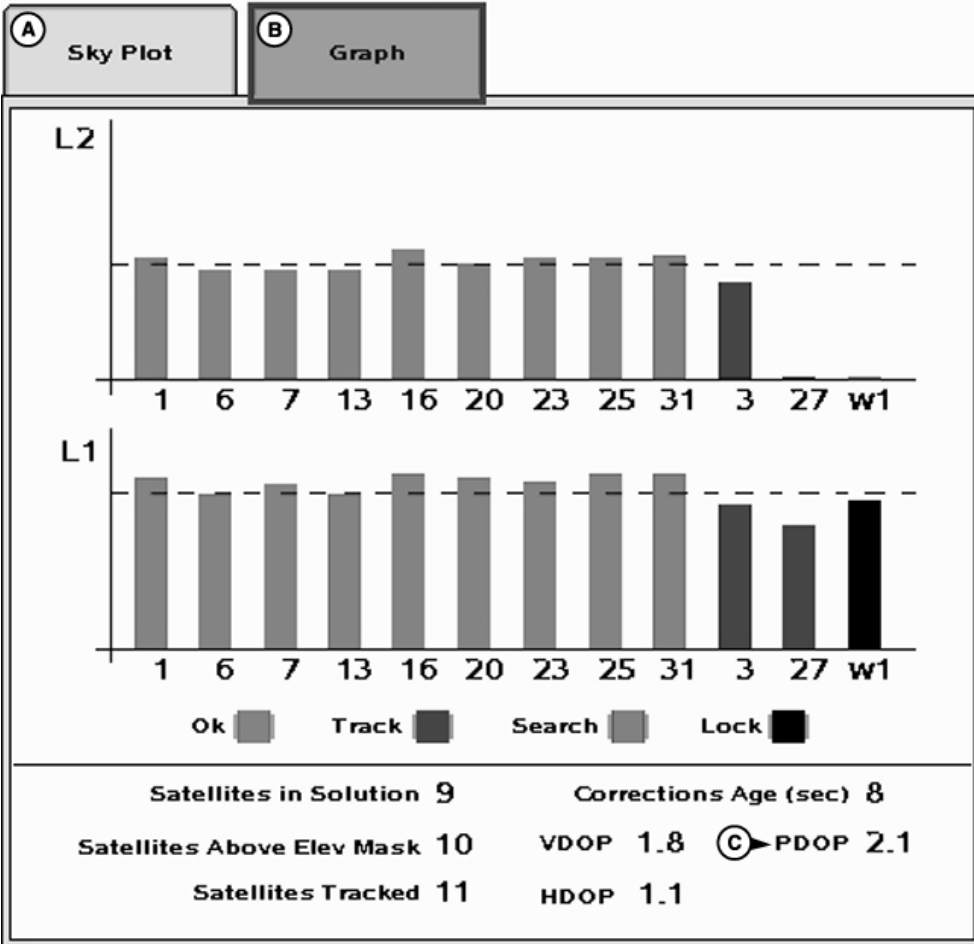

11:29am

A—SkyPlot B—Graph C—PDOP

Continued on next page

OUO6050,000227C -19-14NOV06-1/2

StarFire iTC - Satellites

A Sky Plot

B Graph

Satellite Tracking					
Sat ID	Position		L1 SNR	L2 SNR	Status
	Elv	Azm			
1	36	119	52	40	OKsf2
6	9	43	46	36	OKsf2
7	25	103	48	36	OKsf2
13	22	309	46	35	OKsf2
16	73	131	52	43	OKsf2
20	46	236	51	38	OKsf2
23	57	313	51	40	OKsf2
25	41	66	52	40	OKsf2
31	33	65	53	41	OKsf2
3	11	155	44	0	Track
27	1	264	36	32	Low
w1	NA	NA	44	NA	Lock

Satellites in Solution 9

Satellites Above Elev Mask 10

Satellites Tracked 11

Corrections Age (sec) 8

VDOP 1.8 **PDOP 2.1**

HDOP 1.1

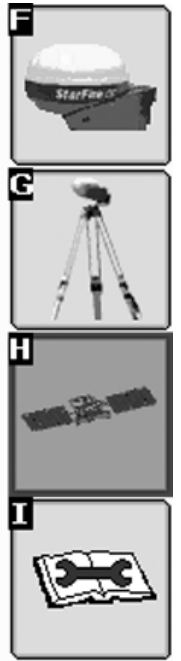

11:29am

StarFire iTC - Satellites

A—SkyPlot B—Graph C—PDOP

PDOP operating values should remain BELOW 3.5 DURING ALL AUTOTRAC OPERATIONS, especially RTK high precision operations. As the value of PDOP rises above 3.5, position accuracy will be compromised.

signals high PDOP values (4 to 20+) will be experienced for upwards of 15 minutes (under normal conditions).

As a rule, when the GPS receiver is warming up from being in a powered off state and gathering satellite

It is important to monitor PDOP along with GPS signal quality while performing field operations.

StarFire Signal Monitoring System

StarFire iTC - Main

(A) Info

(B) Setup

(C) Activations

(D) Serial Port

Position Mode **3Dsf2**

Differential Mode **RTG**

Lat (°) **41°38'9.52"N**

Lon (°) **93°46'32.80"W**

Altitude (m) **304.869**

GPS Course (°) **342**

GPS Speed (kph) **0.0**

Accuracy (%)

100

GPS Signal (%)

60

Diff Signal (dB)

10

Roll Angle (°)

0.5

Yaw Rate (°/sec)

0

(F)
StarFire

(G)
StarFire

(H)
StarFire

(I)
StarFire

11:30am

StarFire iTC Main

A—Info
B—Setup

C—Activations

D—Serial Port

E—Accuracy (%), GPS Signal (%), Diff Signal (dB)

Continued on next page

OUO6050,000227D -19-25NOV06-1/5

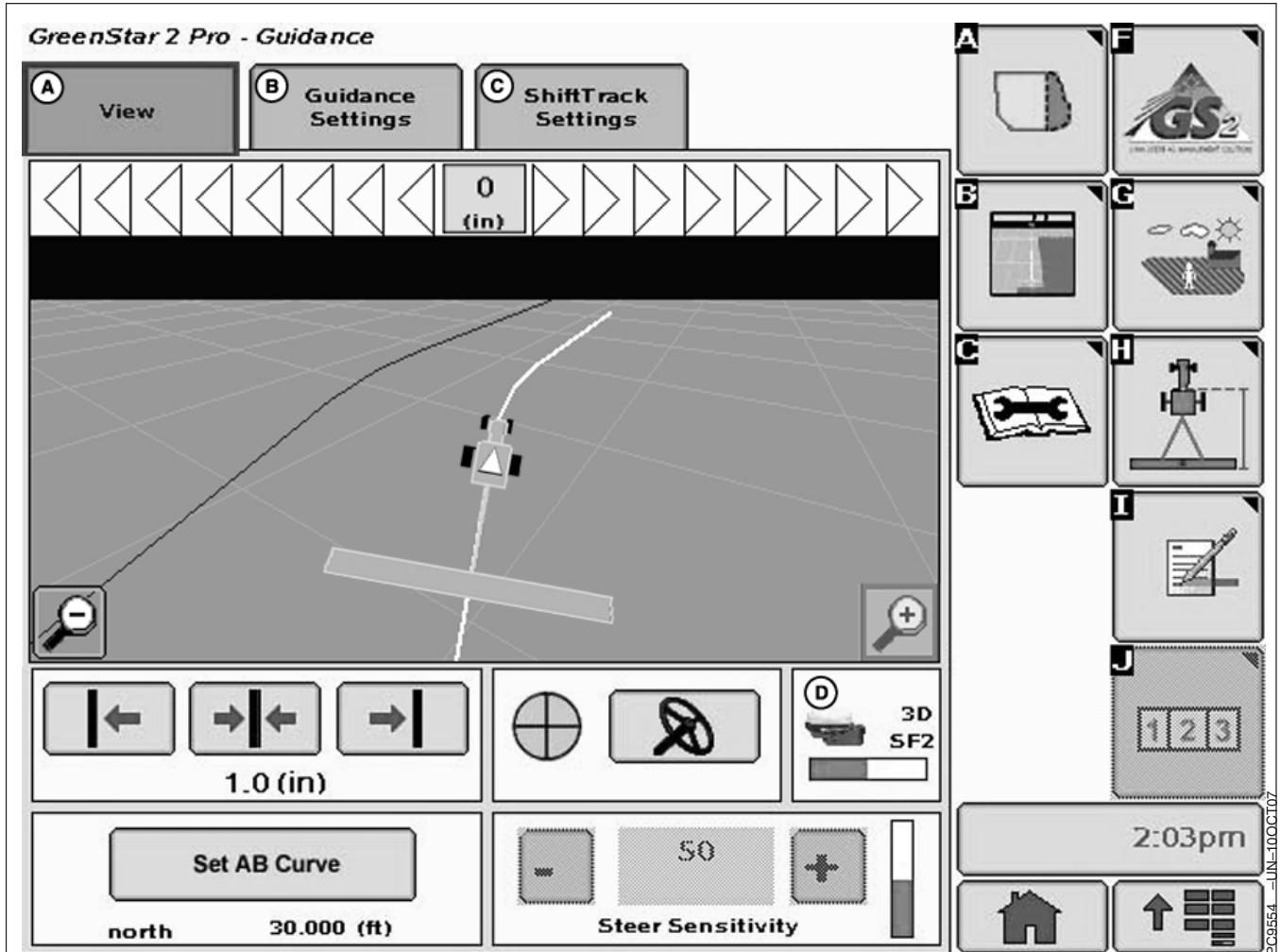

GreenStar2 Pro - Guidance

A—View

B—Guidance Settings

C—ShiftTrack Settings

D—Signal Quality

The GS2 alerts the operator when the current StarFire signal is not accurate. There are three levels of this warning system (Normal, Marginal, and Poor). The levels are determined both by the StarFire Receiver's PDOP value and the number of satellites being

tracked. It is recommend that if the StarFire receiver is being used in high accuracy operations that care be taken when the StarFire Signal Monitoring system indicates that the current status is Marginal or Poor, as accuracy degradation may occur.

Continued on next page

OUO6050,000227D -19-25NOV06-2/5

RTK Base Station Setup

Normal

PC9387 -UN-17OCT06

- Green Bar
- Normal Operating Range
- Acceptable range for high accuracy operations
- PDOP value: 0 - 3.5
- Greater than or equal to 7 satellites being tracked

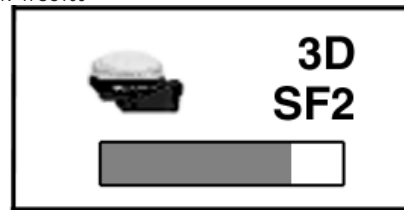

Normal

OOU6050,000227D -19-25NOV06-3/5

Marginal

PC9388 -UN-17OCT07

- Orange Bar with Permanent Caution Sign
- Marginal Operating Range
- Moderate risk of accuracy degradation - caution is advised
- PDOP value: 3.5 - 4.5
- Less than or equal to 6 satellites being tracked

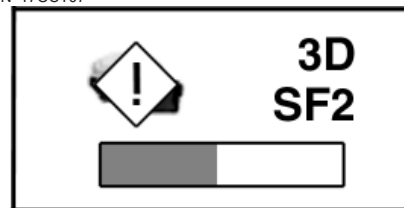

Marginal

OOU6050,000227D -19-25NOV06-4/5

Poor

PC9388 -UN-17OCT07

- Red Bar and Flashing Caution Sign
- Poor Operating Range
- Significant risk of accuracy degradation - high accuracy operations are not advised
- PDOP value greater than 4.6
- Less than or equal to 5 satellites being tracked

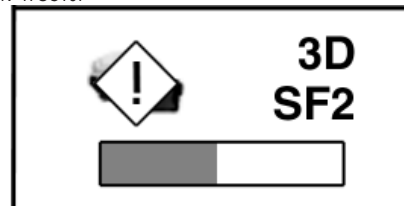

Poor

OOU6050,000227D -19-25NOV06-5/5

Antenna Height

PC9393 -UN-23OCT06

RTK Shared Base Station: Antenna Height

In order to maintain a good RTK Radio link, the antenna must be mounted high enough to radiate over the earth's curvature and any obstacles. As shown in the figure, the curve of the earth can block the signal from the RTK link. If the radiating base station radio antenna is mounted too low, the broadcasting range will be drastically reduced.



OOU6050,000227E -19-25NOV06-1/1

Specific Tower Setup Information

It is recommended that the receiver be, at minimum, 9.1 m (30 ft) away from the tower to prevent both Shading and Multipathing. This distance may vary depending on the frame design of the tower or structure that you are mounting it around.

When using the 91 m (300 ft) extension harness, do not cut the harness to the length needed. This harness has built in voltage protection and is shielded. Cutting the harness will limit the effectiveness of the harness and will cause failures of either the radio or the receiver due to static electricity build up on the harness. This harness was built to be buried underground, so it is suggested to bury all extra harness underground to protect the harness.

After deciding what structure that you will be mounting your base station on, there are five different ways to set up your base station.

- Utilizing Both The 91 m (300 ft) RTK Extension Harness And Low Loss Coax Cable
- Utilizing The RTK Extension Harness
- Utilizing A Repeater
- Utilizing Just Low Loss Coax Cable
- Leaving The Radio And Receiver As A Single Unit

Utilizing Both The 91 m (300 ft) RTK Extension Harness And Low Loss Coax Cable



PC9555 -UN-06NOV06

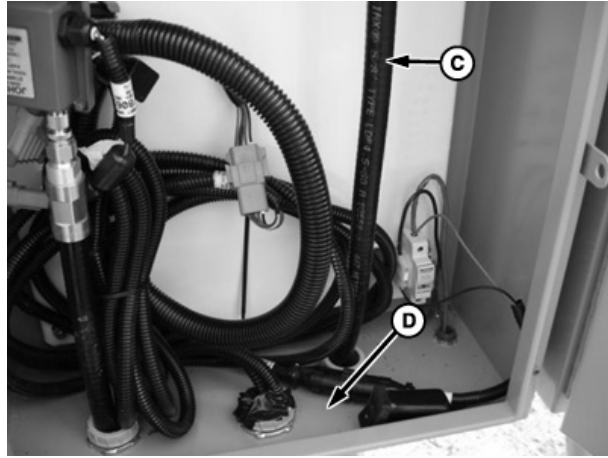

PC9556 -UN-06NOV06

A—91.4 m (300 ft) RS232 Cable from receiver

B—Coax cable connection from antenna

C—Coax running up tower to antenna

D—Coax looped under electrical box

This base station setup allows the placement of the receiver to be up to 91.4 m (300 ft) away from the

radio, giving the base station an absolute clear view of the sky.

OOU6050,0002281 -19-25NOV06-1/2

The radio, usually installed in a secure location at the bottom of a tower, is then connected to low loss coax that is ran up the tower to the antenna.

- A**—Antenna
- B**—Low-Loss Coax Cable
- C**—91.4 m (300 ft) RS232 Cable

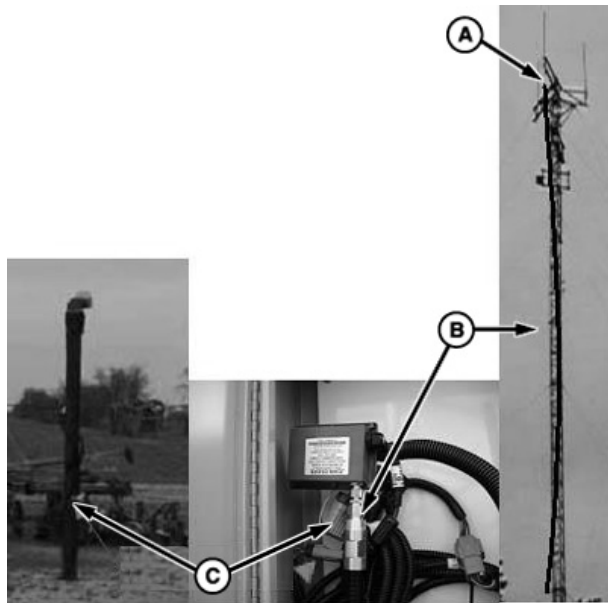

PC9557 -UN-06NOV06

OOU6050,0002281 -19-25NOV06-2/2

Utilizing The RTK Extension Harness

This base station setup allows you to mount the receiver at a secure location and mounting the radio, with antenna, to an elevated position, and utilizing 91 m (300 ft) of RS232 cable between the receiver and radio.

- A—Radio mounted on tower
- B—Base Station Receiver

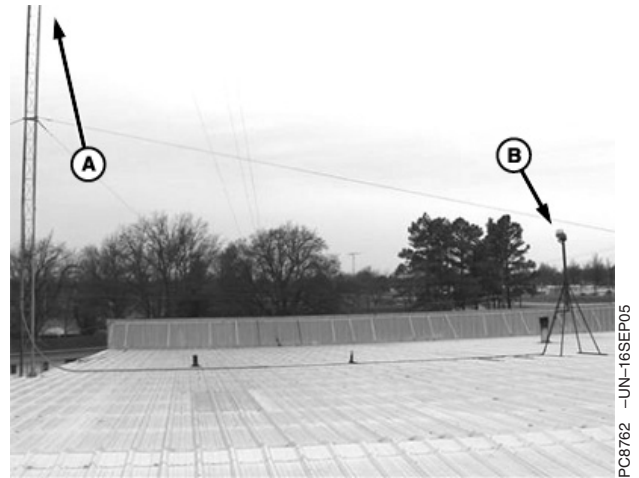

OOU6050,0002282 -19-25NOV06-1/1

Utilizing A Repeater

This base station setup allows the placement of the receiver and radio in a location with no obstructions. A repeater, with its own power source, is placed at an elevated location. The base station radio sends its signal up to the repeater and the repeater then sends out the signal.

NOTE: With this type of base station setup, no other repeaters can be used with the base station.

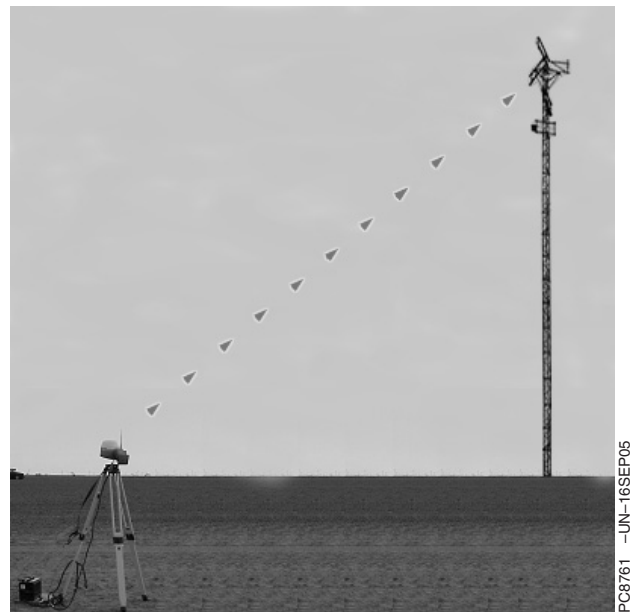

OOU6050,0002283 -19-25NOV06-1/1

Utilizing Just Low Loss Coax Cable

This base station set up leaves the receiver and radio in a secure location and using low loss coax cable running to the antenna at an elevated position.

- A—Receiver and Radio
- B—Coax Cable

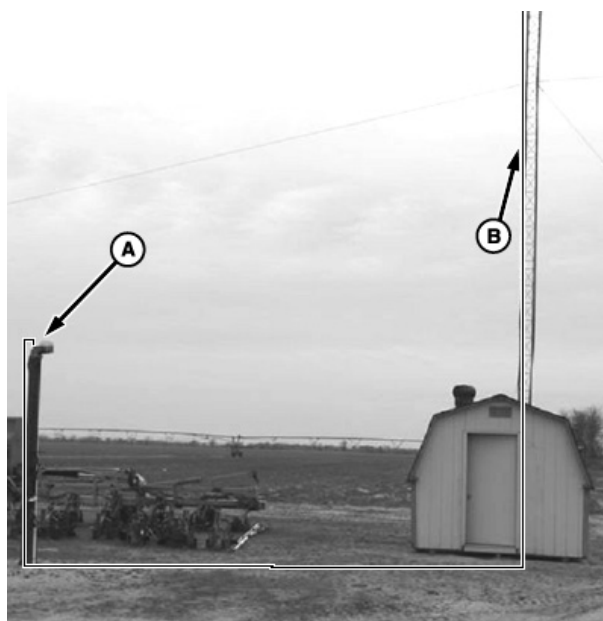

OOU6050.0002284 -19-14NOV06-1/1

Leaving The Radio And Receiver As A Single Unit

This base station setup keeps the receiver and radio as a single unit usually mounted in an elevated location.

IMPORTANT: receiver must have a clear view of the sky and must be free of Multipathing.

The receiver must not move. Any movement of the receiver will result in movement of the vehicle receivers.



OOU6050.0002285 -19-14NOV06-1/1

Troubleshooting and Diagnostics

Accessing GREENSTAR 2 Diagnostic Addresses

PC8664 -UN-05AUG05

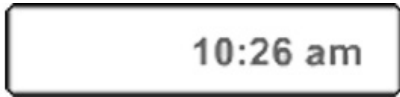

MESSAGE CENTER button (showing time)

PC8663 -UN-05AUG05



MENU button

Message Center screen can be reached by pressing MESSAGE CENTER button (showing time) or MENU button then MESSAGE CENTER button (With Info Icon).

PC8655 -UN-05AUG05



MESSAGE CENTER button (With Info Icon)

OUC6050,0002234 -19-14NOV06-1/4

Select Diagnostic Address icon (soft-key G)

Message center will display all active warning, alert messages and icons.

PC8668 -UN-05AUG05

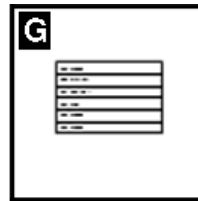

DIAGNOSTIC ADDRESSES soft-key (G)

Continued on next page

OUC6050,0002234 -19-14NOV06-2/4

Diagnostic Addresses

NOTE: Diagnostic addresses are available to access specific diagnostic information. This information can assist the John Deere Dealer in diagnosing problems. Different device controllers can be selected from drop-down box, as shown.

Select DIAGNOSTIC ADDRESS button (A). The number of devices available will depend upon machine configuration. The list of addresses can be scrolled up or down with the input device. Selecting an address will show data for that address.

Some addresses are not shown until display is in technician mode.

Technician Mode: Procedure to get display into Diagnostic Technician Mode:

Read all steps before attempting to get display in Technician mode. The steps are time dependent; therefore need to be done in order and timed for successful completion of obtaining technician mode.

- Go to -> **Menu** -> **Message Center** -> **Diagnostic Address** icon (soft-key G) button (A) .
- A hour glass icon will appear when on page **Message Center - Diagnostic Addresses** .
When hour glass icon disappears, select **Diagnostic Address** icon (soft-key G) button (A) for 4 seconds.
- Release **Diagnostic Address** icon (soft-key G) button (A) and immediately (within 2 seconds) select the **Diagnostic Address** icon (soft-key G) button (A) again for 4 seconds.
- Release **Diagnostic Address** icon (soft-key G) button (A) and display should now be in **technician mode**.

There will be a white capital T inside a black box on the right side of the Device drop down box if display is in technician mode.

Repeat above procedure if attempt was unsuccessful.

Cancelling Technician Mode:

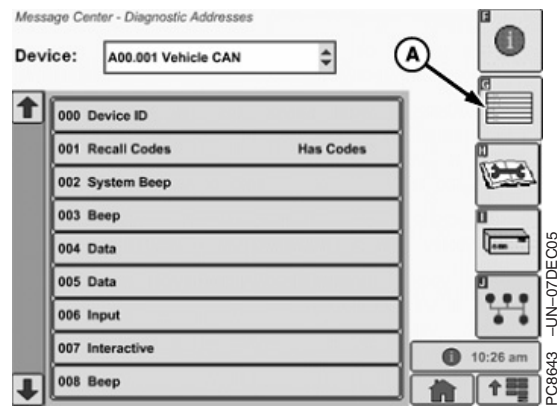

Diagnostic Address Main Screen

A—Diagnostic Address icon (soft-key G)

Select **Diagnostic Address** icon (soft-key G) button (A) for 4 seconds and release.

This action will take the display out of technician mode.

OUC6050,0002234 -19-14NOV06-4/4

Accessing Original GREENSTAR Display Fault Codes

GREENSTAR™ Display IV Fault Codes

Select **Menu** -> **Original GreenStar Display** icon (soft-key H). The 2100/2600 display now is emulating the GreenStar IV display. Then follow directions for each components' fault codes.

Press the INFO button on the GREENSTAR Display. Then press the button next to the entry **GreenStar Display** followed by pressing the button next to the words **Recent Problems**. The codes will be displayed on this page with a short description following the code. To clear these Fault Codes, press the button next to the words **Clear**.

Messages generated by a problem controllers are sent to the GREENSTAR Display over the CAN Bus network.

STARFIRE iTC Diagnostic Trouble Codes

STARFIRE iTC Diagnostic Trouble Codes can be viewed by pressing the INFO button on the GREENSTAR Display. Then pressing the button next to the entry **StarFire Receiver**. Then press the Page button once to get to Page 2. Then press the button next to **Diagnostic Trouble Codes**. This page will show the **Active** and **Previously Active** codes.

Pressing the button next to a code will supply the operator or technician more information about the code. It will give a detailed description, time of last occurrence, and occurrence count. To clear the codes go back to previous page and press button next to **Clear All Codes**.

Terrain Compensation Module Fault Codes

Terrain Compensation Module Fault Codes can be viewed by pressing the INFO button on the GREENSTAR Display. Then pressing the button next to the entry **TCM** followed by pressing the button next to the words **Fault Codes**. The codes will be displayed on this page with a short description following the code. To clear these Fault Codes, press the button next to the words **Clear**.

Parallel Tracking Fault Codes

Parallel Tracking Fault Codes can be viewed by pressing the INFO button on the GREENSTAR Display. Then pressing the button next to the entry **Tracking** followed by pressing the button next to the words **Fault Codes**. The codes will be displayed on this page with a short description following the code. To clear these Fault Codes, press the button next to the words **Clear**.

STARFIRE iTC Diagnostic Addresses

NOTE: Invalid address values will be noted as all 9's (99999999).

Control Unit	Add.	Description	Details
iTC	000	Controller unit identifier	
iTC	001	Diagnostic Trouble Codes	Has Codes - Select entry to display Diagnostic Trouble Codes
iTC	002	System Beep: iTC system beep mode	
iTC	003	GPS time in Universal Time Coordinate format.	Shown in hours:minutes:seconds
iTC	004	DISPLAY: GPS Date based off universal time.	Shown in days, months, years
iTC	005	DISPLAY: Latitude value with TCM corrections.	Shown in \pm degrees
iTC	006	DISPLAY: Longitude value with TCM corrections.	Shown in \pm degrees
iTC	007	DISPLAY: Altitude above sea level	Shown in meters
iTC	008	DISPLAY: GPS heading with TCM corrections.	Shown in degrees
iTC	009	DISPLAY: GPS speed.	Shown in kph
iTC	010	DISPLAY: GPS position status.	0 = none - No GPS position 1 = 2D - GPS position (2 dimensional) 2 = 3D - GPS position (3 dimensional)
iTC	011	DISPLAY: Current differential corrections being used.	0 = No differential correction signal 1 = Other differential correction signal 3 = Government differential correction signal (EGNOS) 6 = Form of RTK differential correction signal 7 = RTK differential correction signal 9 = Dual signal, no external differential correction signal 10 = Dual channel mode receiving EGNOS differential correction signal 11 = Dual channel mode receiving experimental EGNOS differential correction signal 12 = STARFIRE corrections (RTG) 13 = Receiver in dual channel mode receiving STARFIRE correction
iTC	012	DISPLAY: Estimated Quality of receiver position coordinates.	1 to 10
iTC	013	DISPLAY: Estimated Quality of received GPS signal.	Shown in per cent
iTC	14	DISPLAY: Quality of received StarFire corrections signal.	1 to 10
iTC	015	DISPLAY: Age of correction data received.	Shown in seconds
iTC	016	DISPLAY: Angle above horizon which satellites are included in navigational solution.	Shown in degrees
iTC	017	DISPLAY: Number of satellites being tracked	1 to 12
iTC	018	DISPLAY: Number of satellites used for navigation solution.	1 to 12
iTC	19	DISPLAY: Positional Dilution of Precision	

Continued on next page

OOU6050,0002236 -19-25NOV06-1/5

Troubleshooting and Diagnostics

Control Unit	Add.	Description	Details
iTC	020	DISPLAY: Angle of side to side receiver tilt.	Shown in degrees.
iTC	021	DISPLAY: Degrees per second of heading change.	Shown in degrees/second
iTC	022	DISPLAY: Current differential license	0 = StarFire license not processed 1 = StarFire factory license valid 2 = StarFire license valid 3 = StarFire license expired 4 = StarFire license pending 5 = StarFire license grace period valid 6 = StarFire license validation error 7 = StarFire license out of sequence 8 = StarFire license duration invalid 9 = StarFire license type invalid 10 = StarFire receiver needs position 11 = StarFire license grace period empty 12 = StarFire current license is already authentic 13 = StarFire license is retrograded 14 = StarFire license (disabled) 15 = StarFire license (disabled) is cancelled 16 = StarFire license is currently disabled unable to disable 17 = Invalid StarFire receiver 18 = StarFire correction license has invalid level 19 = StarFire correction numbers already entered 20 StarFire correction license cancelled 21 No StarFire correction license (unable to cancel) 22 = StarFire differential correction license needs activation 23 = StarFire differential license requires activation 24 = StarFire license process out of sequence
iTC	023	DISPLAY: Deactivation date of corrections license	Shown in days, months, years
iTC	024	DISPLAY: Remaining GPS days of corrections license	Shown in number of license days left before deactivation of correction signal
iTC	025	DISPLAY: The voltage level of the 12V switched power supply to the unit.	Shown in VDC
iTC	026	DISPLAY: The voltage level of the 12V unswitched power supply to the unit.	Shown in VDC
iTC	027	DISPLAY: The voltage level of CAN HIGH line.	Shown in VDC
iTC	028	DISPLAY: The voltage level of CAN LOW line.	Shown in VDC
iTC	029	DISPLAY: Hours of operation	Shown in number of hours
iTC	30	DISPLAY/MODIFY: Hours of navigation after key off	0 hours 3 hours 6 hours 12 hours 24 hours
iTC	32	DISPLAY/MODIFY: Continue navigation from last known position.	0 = No 1 = Yes
iTC	034	DISPLAY/MODIFY: Distance from top of receiver dome to ground.	Shown in centimeters

Continued on next page

OUO6050,0002236 -19-25NOV06-2/5

Troubleshooting and Diagnostics

Control Unit	Add.	Description	Details
iTC	035	DISPLAY/MODIFY: Distance from pivot point of vehicle to center of receiver.	Shown in cm. Range -508 to +508
iTC	036	DISPLAY/MODIFY: Direction that receiver faces during normal operation	0 = Backward 1 = Forward
iTC	037	DISPLAY/MODIFY: RTK search algorithm status	0 = Off 1 = vehicle 2 = vehicle/repeater 3 = base station (quick survey) 4 = base station (absolute base)
iTC	038	DISPLAY/MODIFY: Current StarFire corrections being used.	0 = differential corrections turned off 1 = SF1 mode 2 = SF2 mode
iTC	039	DISPLAY/MODIFY: Frequency that StarFire corrections are received on.	Shown in kilohertz 1525000 1560000
iTC	040	DISPLAY/MODIFY: Status of WAAS/EGNOS correction signal	0 = WAAS/EGNOS differential corrections are not being used. 1 = WAAS/EGNOS differential corrections are being used.
iTC	041	DISPLAY/MODIFY: Serial port transmission rate.	Shown as RS232 baud rate. 4800 9600 19200 38400
iTC	042	DISPLAY/MODIFY: Serial port message frequency.	Shown in Hertz. 1 or 5
iTC	043	DISPLAY/MODIFY: GGA Output Status	0 = Off 1 = On
iTC	44	DISPLAY/MODIFY: GSA Output Status	0 = Off 1 = On
iTC	045	DISPLAY/MODIFY: RMC Output Status	0 = Off 1 = On
iTC	046	DISPLAY/MODIFY: VTG Output Status	0 = Off 1 = On
iTC	047	DISPLAY: ZDA Output Status	0 = Off 1 = On
iTC	048	DISPLAY: Output of TCM accelerometer raw signal.	Shown in per cent
iTC	049	DISPLAY: Output of TCM accelerometer	Shown as one thousandth of acceleration due to gravity
iTC	053	DISPLAY: Operating temperature of TCM accelerometer component.	Shown in degrees Centigrade
iTC	054	DISPLAY: Latitude as calculated by receiver	Shown in degrees
iTC	055	DISPLAY: Longitude as calculated by receiver	Shown in degrees
iTC	057	DISPLAY: Course as calculated by GPS receiver.	Shown in degrees
iTC	058	DISPLAY: Calibration value of TCM unit on flat surface.	

Continued on next page

OUO6050.0002236 -19-25NOV06-3/5

Troubleshooting and Diagnostics

Control Unit	Add.	Description	Details
iTC	059	DISPLAY: Number of CAN messages received by the GPS receiver.	
iTC	060	DISPLAY: Sensitivity of gyroscope.	Shown in millivolts/degree/second
iTC	061	DISPLAY: Output of gyroscope while vehicle is stationary	Shown in millivolts
iTC	062	DISPLAY: Source address of receiver on the CAN bus.	Shown in hexadecimal
iTC	063	DISPLAY: Temperature sensitivity of Y - axis PWM.	Shown in counts/Kelvin degree
iTC	064	DISPLAY: Measured X- axis sensitivity	Shown in per cent change modulation/centimeter/seconds ²
iTC	065	DISPLAY: X-axis zero modulation at 25 degrees Centigrade.	Shown in centimeter/seconds ² .
iTC	074	DISPLAY: Time left for base station survey.	Shown in hours:minutes:seconds
iTC	075	DISPLAY: Distance of rover from base station	Shown in kilometers
iTC	076	DISPLAY: RTK signal level	Shown in per cent
iTC	077	DISPLAY: Amount of noise affecting reception of signal	Shown in decibels
iTC	078	DISPLAY: Base station identification number	1 to 4095
iTC	079	DISPLAY: RTK radio identification number	Shown as channels 1 - 14
iTC	080	DISPLAY: Percentage of packets received	Shown in per cent
iTC	081	DISPLAY: The voltage level of the 12V switched power supply to the Base Station receiver	Shown in VDC
iTC	082	DISPLAY: Serial number of RTK radio unit	Last 6 numeric digits of the RTK radio serial number
iTC	083	DISPLAY: Software version of RTK radio unit	
iTC	084	DISPLAY: Difference between TCM calculated heading and actual heading	Shown in degrees
iTC	085	DISPLAY: Lateral distance from established parallel tracking A-B line	Shown in millimeters
iTC	086	DISPLAY: Roll induced by high speed acceleration	Shown in millimeters
iTC	087	DISPLAY: Roll induced by low speed acceleration	Shown in millimeters
iTC	088	DISPLAY: Radial acceleration of receiver	Shown in millimeters/seconds ²
iTC	090	DISPLAY/MODIFY: RTK Base Station survey enable.	
iTC	091	RTK Selected Base ID	
iTC	092	Absolute Survey Latitude	
iTC	093	Absolute Survey Longitude	
iTC	094	Absolute Survey Altitude	
iTC	190	DISPLAY: Part number of receiver digital board	Shown as numeric digits
iTC	191	DISPLAY: Serial number receiver digital board	
iTC	192	DISPLAY: Part number of receiver RF board	Shown as numeric digits
iTC	193	DISPLAY: Serial number of receiver RF board	
iTC	228	DISPLAY: iTC boot loader software version	
iTC	233	DISPLAY: Part number for iTC application software	Shows the last seven digits of the part number.

Continued on next page

OUO6050,0002236 -19-25NOV06-4/5

Troubleshooting and Diagnostics

Control Unit	Add.	Description	Details
iTC	234	DISPLAY: iTC application software version number	Shown in ascii
iTC	236	DISPLAY: Serial Number of iTC receiver assembly	Shown as 6 digits or less

OUO6050.0002236 -19-25NOV06-5/5

Fault Codes—StarFire iTC

Stored fault codes indicate that a problem has been detected. Stored fault codes will remain in memory until they are cleared by operator. It is possible that fault condition is no longer active.

Continued on next page

OUO6050.0002237 -19-14NOV06-1/3

Troubleshooting and Diagnostics

Fault Code	Description	Problem	Solution
523319.18	Low switched voltage	low voltage on key switched power supply.	Check battery voltage, check grounds, check harness. Contact dealer if problem persists.
523792.18	Low unswitched voltage	TCM has detected low voltage on unswitched battery power supply.	Check battery voltage, check grounds, check harness. Contact dealer if problem persists.
523792.1	No unswitched voltage	TCM has detected no voltage on unswitched battery power supply. TCM is unable to save setup changes when key is turned off.	Check battery voltage, check grounds, check fuses and harness. Contact your John Deere dealer.
2028.12	No STARFIRE communication	TCM has lost communication with STARFIRE receiver	Check TCM harness to ensure proper connection between STARFIRE Receiver and TCM. Check CAN voltages. Contact your John Deere dealer.
523773.3	StarFire CAN voltage out of range	StarFire CAN High signal voltage is out of range high.	Check TCM harness to ensure proper connection between STARFIRE Receiver and TCM. Check CAN STARFIRE voltages. Contact your John Deere dealer.
523773.4	StarFire CAN voltage out of range	StarFire CAN High signal voltage is out of range low.	Check TCM harness to ensure proper connection between Receiver and TCM. Check CAN voltages. Contact your John Deere dealer.
523774.3	StarFire CAN voltage out of range	StarFire CAN Low signal voltage is out of range high.	Check TCM harness to ensure proper connection between STARFIRE Receiver and TCM. Check CAN voltages. Contact dealer.
523774.4	StarFire CAN voltage out of range	StarFire CAN Low signal voltage is out of range low.	Check TCM harness to ensure proper connection between STARFIRE Receiver and TCM. Check CAN voltage. Contact your John Deere dealer.
956.16	Roll Sensor out of range	Internal Roll Sensor is out of normal operating range. TCM cannot correct position for roll angles.	Contact your John Deere dealer.
2146.14	Temp Sensor out of range	Internal Temperature Sensor is out of normal operating range.	Contact your John Deere dealer.
523309.7	Yaw Sensor not responding	Internal Yaw Sensor is not responding. TCM cannot compensate for terrain changes.	Contact your John Deere dealer.
523309.16	Yaw Sensor out of range	Internal Yaw Sensor is out of normal operating range. TCM cannot compensate for terrain changes.	Contact your John Deere dealer.
523310.2	Memory Error	An internal memory error has occurred.	Contact your John Deere dealer.
523442.31	No StarFire Fore/Aft setting	StarFire Fore/Aft setting has not been entered for this vehicle. Please go to SETUP TCM.	See FORE/AFT in TCM or StarFire iTC section.
523441.31	No StarFire Height setting	StarFire Height setting has not been entered for this vehicle. Go to SETUP TCM.	See HEIGHT in TCM or StarFire iTC section.

Continued on next page

OUO6050,0002237 -19-14NOV06-2/3

Troubleshooting and Diagnostics

Fault Code	Description	Problem	Solution
2146.13	TCM not calibrated	TCM has not been calibrated for this vehicle. Please go to SETUP TCM to calibrate.	See Calibrating in TCM or StarFire iTC section.
523572.31	Unsafe Shutdown-parameters not stored	TCM was unable to save SETUP changes when key was turned off. Must have unswitched battery voltage after key off to save changes.	Check battery voltage at TCM with key off, check harness. Contact John Deere dealer.

OUO6050.0002237 -19-14NOV06-3/3

Diagnostic Trouble Codes—StarFire iTC

SPN.FMI	SPN Name FMI Description	Tractor Warning Light Level 1 Text
523442.3	antenna location (X axis) (523442) Not Available or Condition Exists (31)	Info No StarFire Fore/Aft Set
523441.3	antenna location (Z axis) (523441) Not Available or Condition Exists (31)	Info No StarFire Height Dimension
523773.3	CAN High line (523773) Voltage Above Normal, or Shorted to High Source (3)	No Lamp CAN HI voltage too high
523773.4	CAN High line (523773) Voltage Below Normal, or Shorted to Low Source (4)	No Lamp
523774.3	CAN Low line (523774) Voltage Above Normal, or Shorted to High Source (3)	No Lamp CAN LO voltage too high
523774.4	CAN Low line (523774) Voltage Below Normal, or Shorted to Low Source (4)	No Lamp CAN HI voltage too low
2854.31	Communications Carrier (2854) Not Available or Condition Exists (31)	No Lamp RTK Rover loss of radio link
232.2	DGPS Differential Correction (232) Data Erratic, Intermittent or Incorrect (2)	Info Corrected GPS position is not available
232.14	DGPS Differential Correction (232) Special Instructions (14)	NA RTK Extend will be lost in # minutes
523572.3	ECU power shutdown error (523572) Not Available or Condition Exists (31)	Info Unsafe Shutdown - parameters not stored
523792.2	ECU Power Supply Voltage #1 (523792) Data Valid but Below Normal Operating Range - Moderately Severe Level (18)	Info Low Unswitched Voltage
523319.2	ECU Power Supply Voltage #1, Switched (523319) Data Valid but Below Normal Operating Range - Moderately Severe Level (18)	Info Low Switched Voltage
168.18	Electrical Potential (Voltage) (168) Data Valid but Below Normal Operating Range - Moderately Severe Level (18)	NA RTK Base Station Low Voltage
841.31	Global Positioning System (GPS) (841) Not Available or Condition Exists (31)	Service Alert Signal interference (from jammer)
522339.3	GPS differential corrections license (522339) Not Available or Condition Exists (31)	Info GPS corrections license has expired
522552.1	Navigation Bus 1 (522552) Root Cause not Known (11)	Service Alert StarFire Network Problem
701558.2	Navigational system position data (701558) Data Erratic, Intermittent or Incorrect (2)	Info GPS position is not available
523310.2	Non-volatile memory read/write (523310) Data Erratic, Intermittent or Incorrect (2)	Info Non-volatile Memory Read/Write Failure
524210.2	Number of Satellites Visible (524210) Data Valid but Above Normal Operating Range - Moderately Severe Level (16)	No Lamp RTK Base Station not using visible satellites
522338.1	Receiver secondary differential correction source (522338) Out of Calibration (13)	Service Alert Receiver not receiving on alternate frequency

Continued on next page

OUO6050,0002238 -19-14NOV06-1/2

Troubleshooting and Diagnostics

SPN.FMI	SPN Name FMI Description	Tractor Warning Light Level 1 Text
956.16	Rollover Sensor (956) Data Valid but Above Normal Operating Range - Moderately Severe Level (16)	Service Alert Roll Accelerometer out of range
524257.1	RTK base station location (524257) Special Instructions (14)	No Lamp RTK Base Station Position Survey in progress
524257.2	RTK base station location (524257) Data Valid but Above Normal Operating Range - Moderately Severe Level (16)	Service Alert RTK Base Station relocation
524209.2	RTK Rover relative distance (524209) Data Valid but Above Normal Operating Range - Moderately Severe Level (16)	No Lamp RTK Rover too far from Base Station
2146.13	Source Address 146 (2146) Out of Calibration (13)	Info TCM not calibrated
2146.14	Source Address 146 (2146) Special Instructions (14)	Service Alert Temp sensor out of range
523309.7	Yaw Gyro (523309) Mechanical System not Responding or Out of Adjustment (7)	Service Alert Yaw Gyro not responding
523309.2	Yaw Gyro (523309) Data Valid but Above Normal Operating Range - Moderately Severe Level (16)	Service Alert Yaw Gyro out of range

OUO6050,0002238 -19-14NOV06-2/2

GreenStar Deluxe - Diagnostic Readings

GreenStar Deluxe - Diagnostic Readings

View **Deere GPS** A

B	→	Latitude	41° 38' 9.72" N
C	→	Longitude	93° 46' 32.79" W
D	→	Course	28.67°
E	→	Speed (mi/h)	0
F	→	Altitude (ft)	998.820
G	→	Position Mode	3D
H	→	GPS Quality	Fix/Differential
I	→	PDOP	1.70
J	→	HDOP	1.20
K	→	VDOP	1.20
L	→	Number of Satellites	9
M	→	Satellite ID's	3,7,13,16,19,20,23,25,27

A



F

B

C



C

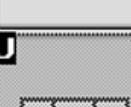

H

I

J

8:44 am





GreenStar Deluxe - Diagnostic Readings

A—View- Deere GPS
 B—Latitude
 C—Longitude
 D—Course

E—Speed
 F—Altitude
 G—Position Mode

H—GPS Quality
 I—PDOP
 J—HDOP

K—VDOP
 L—Number of Satellites
 M—Satellite ID's

Specifications

Unified Inch Bolt and Screw Torque Values

TS1671 -UN-01MAY03



Bolt or Screw	SAE Grade 1				SAE Grade 2 ^a				SAE Grade 5, 5.1 or 5.2				SAE Grade 8 or 8.2			
	Lubricated ^b		Dry ^c		Lubricated ^b		Dry ^c		Lubricated ^b		Dry ^c		Lubricated ^b		Dry ^c	
Size	N•m	lb-in	N•m	lb-in	N•m	lb-in	N•m	lb-in	N•m	lb-in	N•m	lb-in	N•m	lb-in	N•m	lb-in
1/4	3.7	33	4.7	42	6	53	7.5	66	9.5	84	12	106	13.5	120	17	150
													N•m	lb-ft	N•m	lb-ft
5/16	7.7	68	9.8	86	12	106	15.5	137	19.5	172	25	221	28	20.5	35	26
									N•m	lb-ft	N•m	lb-ft				
3/8	13.5	120	17.5	155	22	194	27	240	35	26	44	32.5	49	36	63	46
			N•m	lb-ft	N•m	lb-ft	N•m	lb-ft								
7/16	22	194	28	20.5	35	26	44	32.5	56	41	70	52	80	59	100	74
	N•m	lb-ft														
1/2	34	25	42	31	53	39	67	49	85	63	110	80	120	88	155	115
9/16	48	35.5	60	45	76	56	95	70	125	92	155	115	175	130	220	165
5/8	67	49	85	63	105	77	135	100	170	125	215	160	240	175	305	225
3/4	120	88	150	110	190	140	240	175	300	220	380	280	425	315	540	400
7/8	190	140	240	175	190	140	240	175	490	360	615	455	690	510	870	640
1	285	210	360	265	285	210	360	265	730	540	920	680	1030	760	1300	960
1-1/8	400	300	510	375	400	300	510	375	910	670	1150	850	1450	1075	1850	1350
1-1/4	570	420	725	535	570	420	725	535	1280	945	1630	1200	2050	1500	2600	1920
1-3/8	750	550	950	700	750	550	950	700	1700	1250	2140	1580	2700	2000	3400	2500
1-1/2	990	730	1250	930	990	730	1250	930	2250	1650	2850	2100	3600	2650	4550	3350

Torque values listed are for general use only, based on the strength of the bolt or screw. DO NOT use these values if a different torque value or tightening procedure is given for a specific application. For plastic insert or crimped steel type lock nuts, for stainless steel fasteners, or for nuts on U-bolts, see the tightening instructions for the specific application. Shear bolts are designed to fail under predetermined loads. Always replace shear bolts with identical grade.

Replace fasteners with the same or higher grade. If higher grade fasteners are used, tighten these to the strength of the original. Make sure fastener threads are clean and that you properly start thread engagement. When possible, lubricate plain or zinc plated fasteners other than lock nuts, wheel bolts or wheel nuts, unless different instructions are given for the specific application.

^aGrade 2 applies for hex cap screws (not hex bolts) up to 6. in (152 mm) long. Grade 1 applies for hex cap screws over 6 in. (152 mm) long, and for all other types of bolts and screws of any length.

^b"Lubricated" means coated with a lubricant such as engine oil, fasteners with phosphate and oil coatings, or 7/8 in. and larger fasteners with JDM F13C zinc flake coating.

^c"Dry" means plain or zinc plated without any lubrication, or 1/4 to 3/4 in. fasteners with JDM F13B zinc flake coating.

DX,TORQ1 -19-24APR03-1/1

Metric Bolt and Screw Torque Values

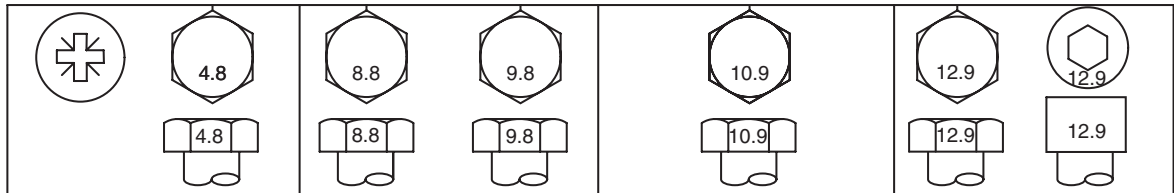

TS1670 -JUN-01MAY03

Bolt or Screw	Class 4.8				Class 8.8 or 9.8				Class 10.9				Class 12.9			
	Lubricated ^a		Dry ^b		Lubricated ^a		Dry ^b		Lubricated ^a		Dry ^b		Lubricated ^a		Dry ^b	
Size	N•m	lb-in	N•m	lb-in	N•m	lb-in	N•m	lb-in	N•m	lb-in	N•m	lb-in	N•m	lb-in	N•m	lb-in
M6	4.7	42	6	53	8.9	79	11.3	100	13	115	16.5	146	15.5	137	19.5	172
									N•m	lb-ft	N•m	lb-ft	N•m	lb-ft	N•m	lb-ft
M8	11.5	102	14.5	128	22	194	27.5	243	32	23.5	40	29.5	37	27.5	47	35
			N•m	lb-ft	N•m	lb-ft	N•m	lb-ft								
M10	23	204	29	21	43	32	55	40	63	46	80	59	75	55	95	70
	N•m	lb-ft														
M12	40	29.5	50	37	75	55	95	70	110	80	140	105	130	95	165	120
M14	63	46	80	59	120	88	150	110	175	130	220	165	205	150	260	190
M16	100	74	125	92	190	140	240	175	275	200	350	255	320	235	400	300
M18	135	100	170	125	265	195	330	245	375	275	475	350	440	325	560	410
M20	190	140	245	180	375	275	475	350	530	390	675	500	625	460	790	580
M22	265	195	330	245	510	375	650	480	725	535	920	680	850	625	1080	800
M24	330	245	425	315	650	480	820	600	920	680	1150	850	1080	800	1350	1000
M27	490	360	625	460	950	700	1200	885	1350	1000	1700	1250	1580	1160	2000	1475
M30	660	490	850	625	1290	950	1630	1200	1850	1350	2300	1700	2140	1580	2700	2000
M33	900	665	1150	850	1750	1300	2200	1625	2500	1850	3150	2325	2900	2150	3700	2730
M36	1150	850	1450	1075	2250	1650	2850	2100	3200	2350	4050	3000	3750	2770	4750	3500

Torque values listed are for general use only, based on the strength of the bolt or screw. DO NOT use these values if a different torque value or tightening procedure is given for a specific application. For stainless steel fasteners or for nuts on U-bolts, see the tightening instructions for the specific application. Tighten plastic insert or crimped steel type lock nuts by turning the nut to the dry torque shown in the chart, unless different instructions are given for the specific application.

Shear bolts are designed to fail under predetermined loads. Always replace shear bolts with identical property class. Replace fasteners with the same or higher property class. If higher property class fasteners are used, tighten these to the strength of the original. Make sure fastener threads are clean and that you properly start thread engagement. When possible, lubricate plain or zinc plated fasteners other than lock nuts, wheel bolts or wheel nuts, unless different instructions are given for the specific application.

^a“Lubricated” means coated with a lubricant such as engine oil, fasteners with phosphate and oil coatings, or M20 and larger fasteners with JDM F13C zinc flake coating.

^b“Dry” means plain or zinc plated without any lubrication, or M6 to M18 fasteners with JDM F13B zinc flake coating.

Declaration of Conformity

John Deere Ag Management Solutions

4140 NW 114th Street

Urbandale, IA 50322

The following GREENSTAR System Components comply with the EU electromagnetic compatibility provisions in directive 2004/108/EC. These components were assessed using the acceptance criteria defined in the harmonized standard ISO 14982:1998.

- Original GreenStar Display
- Mobile Processor
- GreenStar Display 2100 & 2600
- Display Control
- StarFire iTC Receiver
- RTK Radio
- AutoTrac Universal Steering Kit
- GS2 Rate Controller
- iTC Power Module

26 September 2007



A handwritten signature in black ink, reading 'John H. Leinart', is written above the printed name and title.

John H. Leinart
Manager AMS

PC7072B -UN-05OCT07

OOU6050,0000D9B -19-17OCT07-1/1

Safety Note Regarding the Subsequent Installation of Electrical and Electronic Appliances and/or Components

The machine is equipped with electronic components whose function may be influenced by electromagnetic radiation from other appliances. Such influences may be hazardous, so take the following safety instructions into account:

If electrical and electronic appliances are subsequently installed on the machine and connected to the onboard system, the user must verify whether the installation affects the electronics or other components. This applies particularly to:

- Personal Computer
- GPS (Global Positioning System) receiver

Subsequently installed electrical/electronic components must comply with all relevant EMC directives and be CE marked.

Wiring, installation and maximum permissible current supply must be as stated in the installation instructions of the machine manufacturer.

OOU6050,0000D9C -19-04OCT07-1/1

Index

	Page		Page
A		D	
Absolute Base Mode	20-6	Data Log	
Absolute Survey		Accuracy Indicator	25-25
Base Mode	30-1	Differential Mode	25-27
Absolute Survey Base Mode		PDOP	25-26
RTK	30-5	Position Mode	25-27
Accessing Diagnostic Addresses	40-3	Satellites Used	25-26
Accessing Diagnostic Codes	40-3	Signal Quality	25-25
Accuracy Indicator	25-21, 25-25	Date	25-21
Activation		Default Channel	25-18
License	25-4	Diagnostic Addresses	
RTK	25-5	Accessing	40-3
SF2	25-5	Engine Control Unit	40-4
WAAS	25-18	Diagnostic Codes	
ACTIVATIONS tab		Accessing	40-3
StarFire iTC	15-12	Diagnostic Trouble Codes	
Altitude	25-21	StarFire iTC	40-11
Antenna	35-4	Differential	
Attaching		Data Log	25-27
StarFire iTC Receiver	10-1	Differential Correction	
Azimuth	25-29	Setup	25-4
B		E	
Base Station		Elevation	25-29
Info Pages	30-17	Satellites	25-29
Baud Rate		Elevation Mask	25-23
Serial RS232 Output	25-19	Extend Mode	20-4, 30-16
C		F	
Calibration		Fault Codes	
TCM	25-11	StarFire iTC	40-8
Machine Position	15-9, 25-11	Fore/Aft	25-17
CAN High voltage (Vehicle Bus)	15-24	StarFire iTC	15-6
CAN Low voltage (Vehicle Bus)	15-24	H	
Correction Age	25-23	Hardware Part Number	15-24
Correction Frequency		Hardware Serial Number	15-24
StarFire iTC	15-5	Hardware Version	25-28
Correction Mode		HDOP	15-19
StarFire iTC	15-5	Height	25-16
Correction Signal		StarFire iTC	15-7
SF2	25-3	Hours On After Shutdown	25-20
Corrections		StarFire iTC	15-8
OFF/ON	25-18		
Country Restrictions	35-1		
Course	25-21		

	Page		Page
Search Time (sec)	15-24	Radio Channel.	30-12
Serial Number.	15-24	Repeater	30-14
Setup	25-18	TCM	25-4, 25-9
Operating Mode.	30-1	SETUP tab	
Softkey	20-1	StarFire iTC	15-4
Software Number	15-24	SF1	
Status	15-24	World Solution	25-5
Survey		SF2	
Absolute	30-1	Activation	25-5
Quick.	30-1, 30-4	License	25-5
System Overview	35-2	Subscription	25-5
Vehicle	20-3	Signal	
Operating	30-15	Quality	25-25
Repeater	30-1	Signal Quality	25-21
Vehicle Mode	30-1	Signal to Noise Ratio (SNR)	25-29
RTK Radio	35-4	SKY PLOT	15-19
		Softkey	
		RTK	20-1
		Software	
		Load	
		Automatic	25-1
		Manual	25-2
		Software Part Number	15-24
		Software Version	25-28
		Software Version Number.	15-24
		Speed.	25-21
		StarFire iTC	15-1
		ACTIVATIONS tab	15-12
		Correction Frequency	15-5
		Correction Mode	15-5
		Diagnostic Trouble Codes	40-11
		Fault Codes	40-8
		Fore/Aft.	15-6
		Height.	15-7
		Hours On After Shutdown	15-8
		INFO tab.	15-2
		Mount Direction.	15-5
		QuickStart.	15-7
		Receiver	10-1
		Attaching	10-1
		Installing	10-1
		Mounting	10-1
		SERIAL PORT tab	15-15
		SETUP tab	15-4
		TCM Calibration	15-8
		Trouble Codes	40-11
		StarFire Receiver	
		SF2 Correction Signal.	25-3
		Status	
		Satellites	25-29
		Subscription	
		SF2.	25-5
S			
Satellite			
Data Log	25-26		
Predictor	15-23		
SATELLITE INFORMATION	15-19		
Above Elevation Mask.	15-19		
In Solution.	15-19		
L1/L2 GRAPH.	15-19		
SKY PLOT	15-19		
TRACKING CHART	15-19		
TRACKING INFORMATION	15-19		
Satellites			
Above Elevation Mask.	25-23		
Azimuth.	25-29		
Elevation.	25-29		
ID	25-29		
In Solution.	25-23		
Signal to Noise Ratio (SNR)	25-29		
Status	25-29		
Tracked.	25-23		
Tracking	25-29		
Serial Number	25-28		
Serial Port			
Output.	25-4, 25-19		
SERIAL PORT tab			
StarFire iTC	15-15		
Setup			
Differential Correction	25-4		
QuickStart.	25-4, 25-8		
RTK	25-18		
Network ID	30-13		
Operating Mode.	30-1		

	Page		Page
Survey		Y	
Absolute	30-1		
Quick	30-1, 30-4	Yaw Rate	25-23
Switched voltage	15-24		
System Overview	35-2		

T

TCM	
Calibration	25-11
Machine Position	15-9, 25-11
Surface	15-10, 25-12
Fore/Aft	25-17
Height	25-16
Mount Direction	25-10
ON/OFF	25-9
Setup	25-4, 25-9
TCM Calibration	15-8
Time	25-21
Tracking	25-29
TRACKING CHART	15-19
TRACKING INFORMATION	15-19
Trouble Codes	
StarFire ITC	40-11

U

Unswitched voltage	15-24
Update Software	25-1

V

VDOP	15-19
Vehicle	
Info Pages	30-18
Operating	30-15
Repeater	30-1
RTK	30-1

W

WAAS	
Activation	25-18

John Deere Service Keeps You On The Job

John Deere Parts

We help minimize downtime by putting genuine John Deere parts in your hands in a hurry.

That's why we maintain a large and varied inventory—to stay a jump ahead of your needs.



TS100 -UN-23AUG88

DX,IBC,A -19-04JUN90-1/1

The Right Tools

Precision tools and testing equipment enable our Service Department to locate and correct troubles quickly . . . to save you time and money.



TS101 -UN-23AUG88

DX,IBC,B -19-04JUN90-1/1

Well-Trained Technicians

School is never out for John Deere service technicians.

Training schools are held regularly to be sure our personnel know your equipment and how to maintain it.

Result?

Experience you can count on!

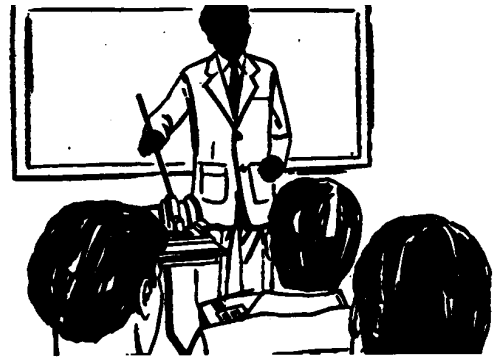

TS102 -UN-23AUG88

DX,IBC,C -19-04JUN90-1/1

Prompt Service

Our goal is to provide prompt, efficient care when you want it and where you want it.

We can make repairs at your place or at ours, depending on the circumstances: see us, depend on us.

JOHN DEERE SERVICE SUPERIORITY: We'll be around when you need us.



TS103 -UN-23AUG88

DX,IBC,D -19-04JUN90-1/1

Free Manuals Download Website

<http://myh66.com>

<http://usermanuals.us>

<http://www.somanuals.com>

<http://www.4manuals.cc>

<http://www.manual-lib.com>

<http://www.404manual.com>

<http://www.luxmanual.com>

<http://aubethermostatmanual.com>

Golf course search by state

<http://golfingnear.com>

Email search by domain

<http://emailbydomain.com>

Auto manuals search

<http://auto.somanuals.com>

TV manuals search

<http://tv.somanuals.com>