

JLTDC 07 condenser tumble dryer

Instruction manual

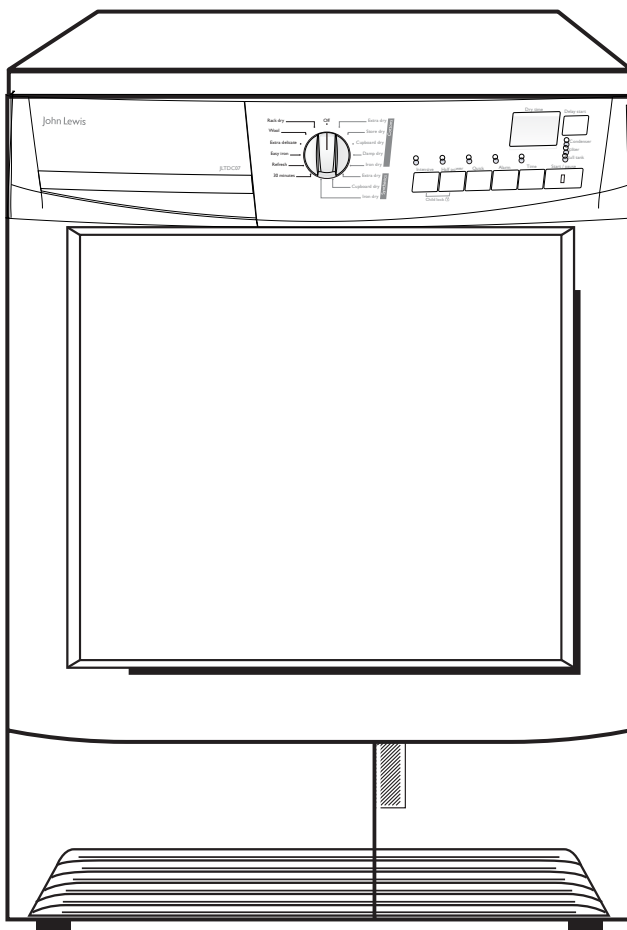

John Lewis



Important Safety Information

It is most important that this instruction book should be retained with the appliance for future reference. Should the appliance be sold or transferred to another owner, or should you move house and leave the appliance, always ensure that the book is supplied with the appliance in order that the new owner can get to know the functioning of the appliance and the relevant warnings.

These warnings have been provided in the interest of safety. You **MUST** read them carefully before installing or using the appliance.

If you are unsure of the meaning of these warnings contact the John Lewis branch from which you purchased the appliance.

Installation

- This appliance is heavy. Care should be taken when moving it.
- It is dangerous to alter the specifications or attempt to modify this product in any way.
- Any electrical work required to install this appliance should be carried out by a qualified electrician or competent person.
- Care must be taken to ensure that the appliance does not stand on the electrical supply cable.
- If the machine is situated on a carpeted floor, please adjust the feet in order to allow air to circulate freely.
- If the tumble dryer is placed on top of a washing machine, it is compulsory to use the stacking kit (optional accessory).
- As some bulky items such as duvets and eiderdowns should be dried in large commercial machines because of their bulk, check with the manufacturer of the item if it is suitable for drying in a domestic machine, even if the dry weight of the item is within the limit advised.
- Please make sure that no gas lighters have accidentally been left in pockets of garments to be loaded into appliance.
- **Danger of explosion:** Never tumble dry items that have been in contact with inflammable solvents (petrol, methylated spirits, dry cleaning fluid and the like). As these substances are volatile, they could cause an explosion. Only tumble dry items washed with water.
- In order to avoid danger of fires caused by excessive drying, do not use appliance to dry the following items: Cushions, quilts and the like (these items accumulate heat).
Items containing rubber foam or materials similar to rubber foam.

Child Safety

- This appliance is designed to be operated by adults. Children should not be allowed to tamper with the controls or play with the product.
- Pets and children have been known to climb into tumble dryers. Please check your drum before use.
- Keep all packaging well away from children.
- When the appliance is to be scrapped, cut off the electrical supply cable and destroy the plug with the remaining cable. Disable the door catch in order to prevent children from becoming trapped inside while playing
- Leave the door slightly ajar when the appliance is not being used. This will allow the seal to be preserved.
- Clean fluff filters after using tumble dryer. To prevent fire risks, do not use the appliance if the fluff filters are damaged.
- Do not allow fluff to accumulate around the dryer.
- Under no circumstances should you attempt to repair the machine yourself. Repairs carried out by inexperienced persons may cause injury or serious malfunctioning. Contact the telephone number given under Repairs - After Sales Service (Page 21).
Always insist on genuine John Lewis spare parts.

Use

- Do not overload the appliance (see programme chart).
- Clothes which are dripping wet should not be placed in the dryer.
- **Risk of fire:** items that have been spotted or soaked with vegetable or cooking oil constitute a fire hazard and should not be placed in the tumble dryer.
- If you have washed your laundry with stain remover you must execute an extra rinse cycle before loading your tumble dryer.

Maintenance and Cleaning

- For information on maintenance and cleaning your tumble dryer see page 17 of this Instruction manual.

Service

- This product should only be repaired or serviced by an authorised Service Engineer and only genuine approved spare parts should be used..



Ecological hints

To save energy we recommend that you follow these hints:

- Try to load the maximum capacity of the machine as small loads are **uneconomical**.
- Always load well spun laundry. The higher the spin speed, the lower the electricity consumption and the shorter the drying times.
- Do not over-dry laundry, this avoids creasing and saves energy.
- Clean the filters regularly to avoid excessive drying times and high electricity consumption.
- The room should be well ventilated for the tumble Dryer to operate efficiently. The room temperature should not exceed +35°C during drying.



Environmental Information

- After unpacking please dispose of the packaging with due regard to safety and the environment
- Materials marked with the symbol  are recyclable.
- Check with your local Council or Environmental Health Office to see if there are facilities in your area for recycling this appliance.
- When the appliance is to be scrapped, cut off the power supply cable and make the door closing device unusable to prevent young children from being trapped inside.
- Check with your local Council or Environmental Health Office to see if there are facilities in your area for recycling this appliance.

Warning !



A cut off plug inserted into a 13amp socket is a serious safety (shock) hazard. Ensure that the cut off plug is disposed of safely.



The symbol  on the product or on its packaging indicates that this product may not be treated as household waste. Instead it should be taken to the appropriate collection point for the recycling of electrical and electronic equipment. By ensuring this product is disposed of correctly, you will help prevent potential negative consequences for the environment and human health, which could otherwise be caused by in appropriate waste handling of this product. For more detailed information about recycling of this product, please contact your local council, your household waste disposal service or the shop where you purchased the product.

Contents

For the User

Important Safety Information **2**

- Installation

Description of the Appliance **5**

The Control Panel **9**

- Programme/Time Selector Dial **9**
- Door Release Button **9**
- No Buzzer Button **9**
- Quick Dry Button **9**
- Low Temperature Button **9**
- Delay Start Button **9**
- Display **10**
- Start/Pause Button **11**
- Indicator Lights **11**
- Indicator Lights **11**

Programme Chart **12**

Using your tumble dryer **13**

Drying rack **14-15**

Hints & Tips on Drying **16**

Maintenance and Cleaning **17**

- External cleaning **17**
- Cleaning the door **17**
- Cleaning the filters **17**
- Cleaning the condenser unit **17-18**
- Emptying the water reservoir **18**
- Cleaning the air intake grill **18**
- Cleaning the drum **18**

Adjusting the level of conductivity **19**

Something Not Working **20**

Repairs - After Sales Service **21**

Spare parts **21**

For the Installer

Installation **6**

Technical Specifications **6**

- Unpacking **7**
- Positioning **7**
- Stacking kit (optional accessory) **7**
- Door reversal **7**

Electrical connection **8**

Guide to using the Instruction Manual

The following symbols will be found in the text to guide you throughout the instructions:

 **Safety instructions**

 **Hints and tips**

 **Environmental information**



 This appliance complies with the following E.E.C. Directives:
- 73/23 EEC of 19.2.73 (Low Voltage Directive) and subsequent modifications;
- 89/336 EEC of 3.5.89 (Electromagnetic Compatibility Directive) and subsequent modifications.

Description of the Appliance

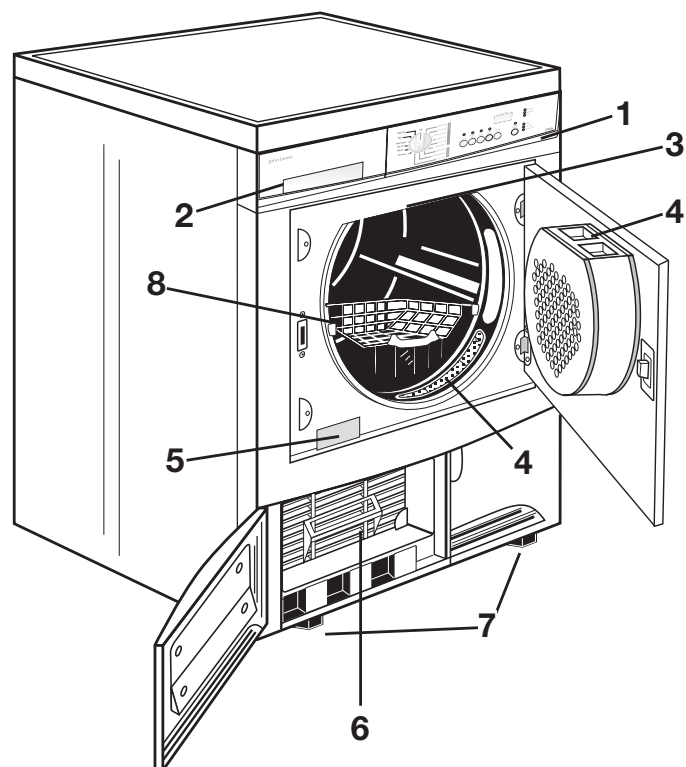
- 1 Control panel
- 2 Water reservoir
- 3 Drum Light
- 4 Fluff filters
- 5 Rating Plate
- 6 Condenser unit
- 7 Adjustable feet
- 8 Drying rack



Installation

-  It is dangerous to alter the specifications or attempt to modify this product in any way.
-  Care must be taken to ensure that the appliance does not stand on the electrical supply cable.
-  Any electrical work required to install this appliance should be carried out by a qualified electrician or competent person.

Technical Specifications

DIMENSIONS	Height Width Depth	85 cm (33.5") 60 cm (23.6") 58 cm (22.8")
POWER SUPPLY VOLTAGE TOTAL POWER ADSORBED		230-240 V/50 Hz 2350 W (13A)
MAX LOAD CAPACITY	Cotton, linen Synthetics	7 kg (15.4 lbs) 3 kg (6.6 lbs)
DRUM VOLUME		108 l
CONSUMPTIONS	Cotton, linen (1000 rpm) Cotton, linen (1000 rpm) Synthetics (1200 rpm)	4.50 kWh (7 kg cupboard dry) 3.40 kWh (7 kg iron dry) 1.60 kWh (3 kg cupboard dry)

Unpacking

Warning !

-  Slide out the polythene bag containing the polystyrene block before using the appliance. Pull off adhesive strips from inside machine on top of drum. Keep all packaging away from children.

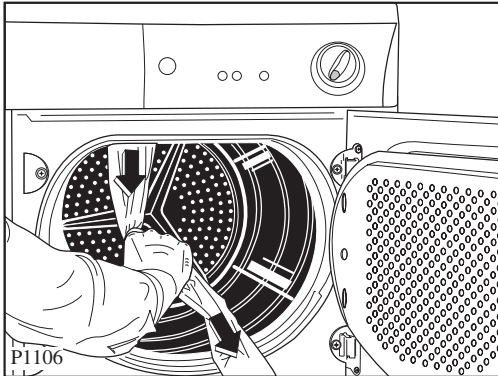

-  **Should the appliance be moved, it must be transported vertically.**

Remove the rack

The drying rack offers the possibility of drying washable woollen fabrics and sports shoes. The drying rack does not turn with the tumble dryer drum. This enables the drying of woollen garments or sports shoes. When wet, the wool must be moved as little as possible because it tends to become matted. Sports shoes could damage the drum due to their weight.

1. Lift the rack out of the polystyrene protection used for transport and remove it from the tumble dryer drum.
2. Remove the pieces of polystyrene from the drum one at a time.
3. Remove the elastic band from the rack and the rack container.

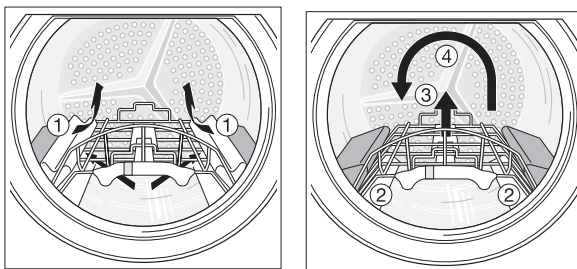

Positioning

It is recommended that, for your convenience, the machine is positioned close to your washing machine. The tumble dryer must be installed in a clean place, where dirt does not build up.

Air must be able to circulate freely all around the appliance. It is important to ensure the air intake grills on the back of the dryer are not obstructed with any materials (e.g. paper, rags etc.). Obstructing the grills could be dangerous or at least seriously impair the efficiency of the tumble dryer.

To keep vibration and noise to a minimum when the dryer is in use, it should be placed on a firm, level surface. Once in its permanent operating position, check that the dryer is absolutely level with the aid of a spirit level. If it is not, raise or lower the feet until it is.

The feet must never be removed.

Do not restrict the floor clearance through deep-pile carpets, strips of wood or similar. This might cause heat build-up which would interfere with the operation of the appliance.

Important

The hot air emitted by the tumble dryer can reach temperatures of up to 60°C. The appliance must be sited in a well ventilated room but not be installed on floors which are not resistant to high temperatures.

When operating the tumble dryer, the room temperature must not be lower than +5°C and higher than +35°C, as it may affect the performance of the appliance.

Stacking kit (optional accessory)

It should be possible to stack your new dryer on top of a front loading washing machine with cover's depth between 48 and 60 cm.

Read carefully the instructions supplied with the stacking kit.

Please contact your local John Lewis branch for further advice.

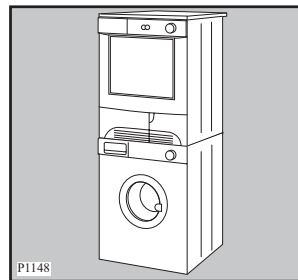

Door reversal

To make it easier to load or unload the laundry the door can be reversed.

This operation must be carried out by qualified personnel.

Please contact The telephone number given under Repairs - After Sales Service (page 21).

Electrical connection

Any electrical work required to install this appliance should be carried out by a qualified electrician or competent person.



WARNING: THIS APPLIANCE MUST BE EARTHED.

Should the appliance power supply cable need to be replaced, this must be carried out by a Service Force agent (see page 21).

The manufacturer declines any liability should this safety measure not be observed.

Before switching on, make sure the electricity supply voltage is the same as that indicated on the appliance's rating plate. (See picture on page 5).

The appliance is supplied with a 13amp plug fitted. In the event of having to change the fuse in the plug supplied, a 13amp ASTA approved BS 1363/A fuse must be used.

Should the plug need to be replaced for any reason, proceed as described below. The wires in the mains lead are coloured in accordance with the following code:

Green and Yellow	- Earth
Blue	- Neutral
Brown	- Live

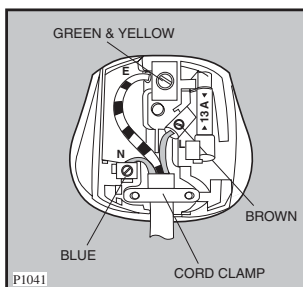

If you fit your own plug, the colours of the wires in the mains lead of your appliance may not correspond with the markings identifying the terminals in your plug.

Proceed as follows:

1. Connect the Green and Yellow (earth) wire to the terminal in the plug which is marked with the letter "E" or the earth symbol \perp or coloured green and yellow.
2. Connect the Blue (neutral) wire to the terminal in the plug which is marked with the letter "N" or coloured black.
3. Connect the Brown (live) wire to the terminal in the plug which is marked with the letter "L" or coloured red.

4. Upon completion there must be no cut, or stray strands of wire present and the cord clamp must be secure over the outer sheath.

WARNING:



A cut off plug inserted into a 13 amp socket is a serious safety (shock) hazard.

Ensure that the cut off plug is disposed of safely.



The plug must still be accessible after the appliance has been installed.



The appliance should not be connected to the electrical supply by means of an extension cable

Permanent connection

In the case of permanent connection it is necessary that you install a double pole switch between the appliance and the electricity supply (mains), with a minimum gap of 3mm between the switch contacts and of a type suitable for the required load in compliance with the current electrical regulations.

The switch must not break the yellow and green earth cable at any point.

The Control Panel

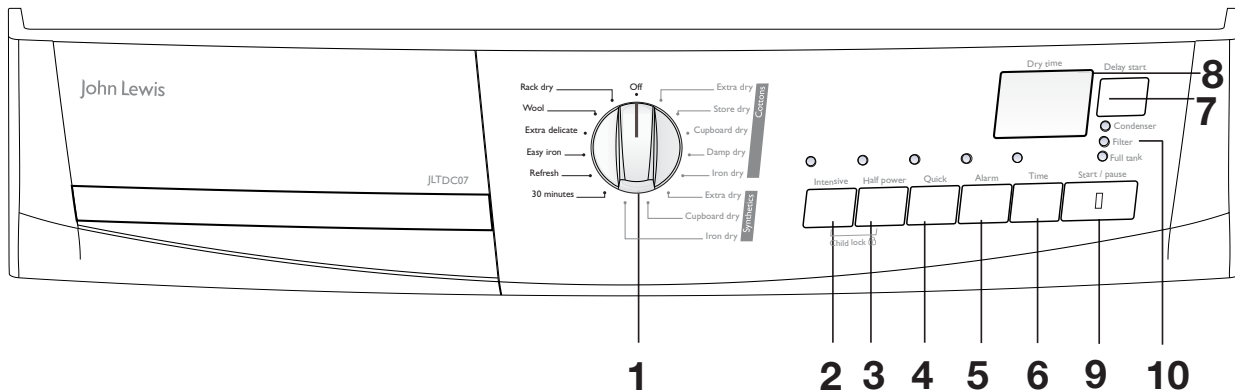

1 Programme/Time Selector Dial

Allows you to select electronically controlled or time controlled drying.

Turn the dial to the required programme or time.

Electronically controlled drying (automatic)

The appliance runs these programmes with the help of sensors which detect the degree of dampness of the laundry.

Simply select the programme according to the type of laundry and degree of drying required.

Time controlled drying

This can be used to finish off drying if necessary. Select the 30 minute programme for cottons or synthetics.

To cancel a programme which is running, turn the programme selector dial to “Off”.

At the end of drying, turn the selector dial to “Off” to switch the machine off before removing the laundry.

If the programme selector dial is turned to another position, when the machine is running, the buzzer will sound and the programme phase indicator lights will flash.

2 Intensive Button

For gentle drying of frequently-worn textiles. Programme starts on full heat setting, which is then reduced towards the end of the programme to ensure gentle care of laundry.

3 Half Power Button

Pressing this button allows drying to be performed at a lower temperature, for delicate items.

The corresponding pilot light comes on.

This option can also be used for time controlled drying. This option **cannot** be selected with QUICK and INTENSIVE programme.

4 Quick dry Button

By depressing this button the drying time is reduced in the following COTTON programmes:

- EXTRA DRY
- CUPBOARD DRY
- STORE DRY

The corresponding pilot light comes on.

This option **cannot** be selected with HALF POWER function.

5 Alarm off Button

A buzzer sounds

- when selecting the programme
- when depressing the buttons
- when an incorrect option selection is made
- when the programme selector dial is turned to another position during the programme or when you depress an option button during the cycle
- at the end of the programme
- when the water reservoir is full
- if the machine is not working correctly
- when the small door at the bottom is open.

By depressing the button the acoustic signal is switched off.

The corresponding light comes on.

6 Time button

This option can be used for WOOL and RACK DRY programmes.

Select the required programme run time, settable with an interval of 10 min, from 30 min. up to 180 minutes.

Press the TIME button as many times as necessary until the required programme running time is shown in the display

7 Delay Start button

By pressing the DELAY START button, the start of a programme can be delayed by between 30 minutes (30') and a maximum of 20 hours (20h).

This option must be selected after having selected the programme and before pressing START/PAUSE to start the programme.

Every time the button is pressed, the time is increased by 30 minutes until the display shows a delay of 2 hours. After this, the delay is increased hour by hour.

If 20h is displayed and you press the button again, the time delay will be cancelled. The display will show 0' and then the duration of the selected programme.

To activate the count down, the START/PAUSE button has to be pressed. The amount of time remaining until the programme is set to start is continuously displayed (e.g. 12h, 11h, 10h, ... 30' etc).

During the delayed start, it is not possible to change the programme or the delay time selected. To do this, you must first switch off the appliance by setting the programme selector to OFF.

If you wish to add more laundry while the countdown is running, simply open the door. When you close the door, press the START/PAUSE button again to cause the count down to be resumed.

8 Display

The display shows the following information:

- duration of selected programme
- delayed start
- end of programme
- incorrect option selection
- alarm code

- **Duration of selected programme**

After you have selected the programme, its duration (in hours and minutes) appears on the display. It is calculated automatically on the basis of the maximum load being used for each type of fabric and of the required degree of drying.



When the programme starts, the remaining time is displayed every 5 minutes.

- **Delayed start**

If you have selected a delay time by means of the relevant button, the display shows it for 2 seconds; then

it shows the duration of the previously selected programme. The countdown is displayed every 30 minutes until it displays "90 minutes" and then hour by hour.

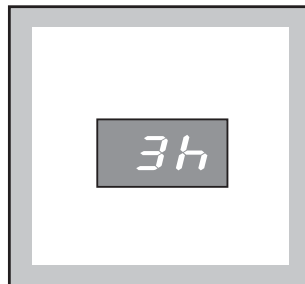

- **End of programme**

A **flashing zero** indicates the end of the programme and it is displayed after the "anti-creasing" phase.

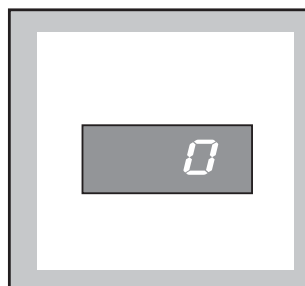

- **Incorrect option selection**

If you select an option that is not compatible with the programme you have selected, the display shows **Err** (error).

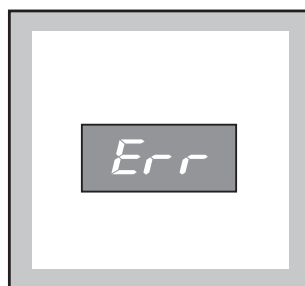

This code will reappear during the execution of the programme if you press one of the option buttons.

- **Alarm code**

In the case of a functional problem, the display shows an alarm code (e.g. E21). See page 18 for more detailed information.

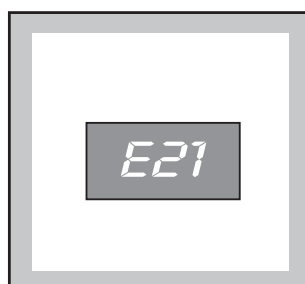

- **“Drying”**

This light indicates that the appliance is in the drying phase.

- **“Cooling”**

This light indicates that the appliance is in the cooling phase. At the end of drying, there is a 10 minute cooling phase to cool the laundry.

- **“End”**

This light illuminates at the end of the cooling phase, during the anti-creasing phase and at the end of the programme.

9 Start/Pause button

Press this button to start the dryer after having selected the programme and any required options.

The relevant light will stop flashing. If you have chosen a delayed start, the machine will begin the countdown.

If the door of the appliance or the small door at the bottom is opened while the programme is running, this button must be pressed again after closing the door in order to restart the programme from the point at which it was interrupted.

This button must also be depressed after a power failure and after having re-inserted the water reservoir, if it has been emptied in the middle of a programme after the “FULL TANK” light has illuminated.

In both cases the light of the Start/Pause button flashes to remind you that the start button needs to be pressed again.

10 Indicator Lights

These lights indicate the following functions:

“Filter” light

This light illuminates at the end of the programme to remind you that the filters must be cleaned.

“Full Tank” light

This light illuminates at the end of the programme to remind you that the water reservoir must be emptied out. If this light illuminates during a programme this means that the water reservoir is full. The buzzer sounds, the programme stops, the light of the Start/Pause button flashes.

“Condenser” light

It comes on every 80 cycles to remind you that the condenser must be cleaned.

Programme Chart

Automatic drying (electronic programmes)

Type of laundry	Degree of drying required	Max-load ⁽¹⁾
Cotton	Extra dry	7 kg
	Store dry	7 kg
	Cupboard dry	7 kg
	Damp dry	7 kg
	Iron dry	7 kg
Synthetics	Extra dry	3 kg
	Cupboard dry	3 kg
	Iron dry	3 kg
Synthetics	Refresh	2.5 kg
Synthetics	Easy iron	2.5 kg
Synthetics or mixed fabrics which do not require ironing	Extra delicate	2.5 kg
Sweaters, wollen pullover	Wool	1 kg
Sport shoes	Rack dry	1 pair

- Refresh and Easy iron are special programmers for synthetics.
- Extra delicate cycle is a special programme for synthetics or mixed fabrics which do not require ironing, and need to be "Store dry".
- Wool - for gentle drying of one woollen garment, washed and spin-dried at 1000 rpm. (see page 14)
- Rack dry cycle is a special programme for gentle drying of one pair of sportshoes.

Time controlled drying

Type of laundry	Drying time	Max-load ⁽¹⁾	Programme selector dial position
SYNTHETICS	30 min	3 kg	30' minutes

(1) Never overfill the drum (do not load large quilts, for example).

Drying times vary according to:

- The type of laundry
- The size of the load
- The degree of water extraction obtained during the spin cycle of the washing machine
- The degree of dryness required

Cooling 10 minutes

This position on the programme selector dial can be used to freshen garments (e.g. to remove a persistent odour of moth-balls).

Load

It is often difficult to estimate the weight of items to be dried. We therefore recommend that you adopt the following guidelines:

- **cotton, linen:** drum full but not too tightly packed;
- **synthetics:** drum no more than half full;
- **delicate fabrics:** drum no more than one third full.

Using the tumble dryer

Before using your tumble dryer for the first time, we recommend that you to place a few damp cloths inside the appliance and dry for 30 minutes. There may be dust inside a brand new tumble dryer.

Drying

1. Connect the appliance.
2. Open the door (see picture below).

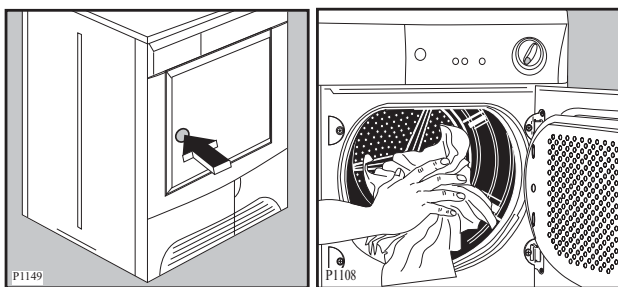

3. Load the items one at a time, shaking them out loosely (see picture above).
4. Close the door. Please check the laundry does not get caught between the door and filter.
5. Select the drying programme or time. The display shows DRYING, COOLING and END come on. The light of the START/PAUSE button flashes and the display shows the duration of the programme.
6. If required, press the HALF POWER button and/or the ALARM OFF button or the QUICK button.
7. Select the DELAY START if required. The selected delay appears on the display for 2 seconds, then the duration of the selected programme is displayed.
8. Press the START/PAUSE button: the corresponding light stops flashing and drying starts. Only the DRYING light stays lit. If you have selected the DELAY START, the machine begins its countdown.

If the programme selector dial is turned to another position, when the machine is running, the buzzer will sound, the programme phase indicator lights will flash.

The drum turns alternately in both directions during drying.

All drying programmes end with a 10 minute cooling phase.

You may remove the laundry after this phase.

The light FILTER illuminate and the buzzer sounds.

The display shows a static zero and END.

9. If the laundry is not removed at the end of the cycle, the dryer performs an **anti-creasing** phase (duration: 30 minutes maximum).

If you do not remove the laundry, the dryer will stop automatically at the end of the anti-creasing phase.

The END and FILTER lights remain lit and the buzzer sounds every 10 seconds for 2 minutes.

The light of the START/PAUSE button goes off and a flashing zero appears on the display.

10. Turn the programme selector dial to “Off”; all the lights go out. The appliance is switched off.

Remove the laundry.

If you open and then close the door before turning the programme selector dial to “Off”, all the lights corresponding to the phases making up the performed programme come on and the display shows the duration of the programme.

After each use

- Clean the filters (see page 17).
- Empty the water reservoir (see page 18).

Removing laundry or loading laundry when necessary

1. Open loading door



Warning!

Laundry and drum can become hot. Risk of burns!

2. Load or remove laundry items.
3. Close the door securely. Lock must audibly lock.
4. Press the START/PAUSE button to continue the drying cycle.

Modifying the programme

To change a programme which is running, first cancel it by turning the programme selector dial to “Off”. Select the new programme and press the START/PAUSE Button.

Drying rack

The drying rack offers the possibility of drying washable woollen fabrics and sports shoes. The drying rack does not turn with the drum.

This allows the drying of woollen garments or sports shoes.

When wet woollen garments must be moved as little as possible because they tend to become matted.



For first removing of the rack, please refer to the instructions for use.

Insert the rack

- The dryer drum must be empty!
 - Remove the rack from the drum at the end of drying.
1. Lift the rack horizontally in the drum.
 2. Guide the rack down until the support bracket at the front rests on the opening.

Drying with the rack

- No part of the garment must come into contact with the drum, otherwise it could get caught up and be damaged.
- For drying with the rack, Only the programmes WOOL or RACK DRY may be used.
- Only dry one garment or one pair of shoes at a time!

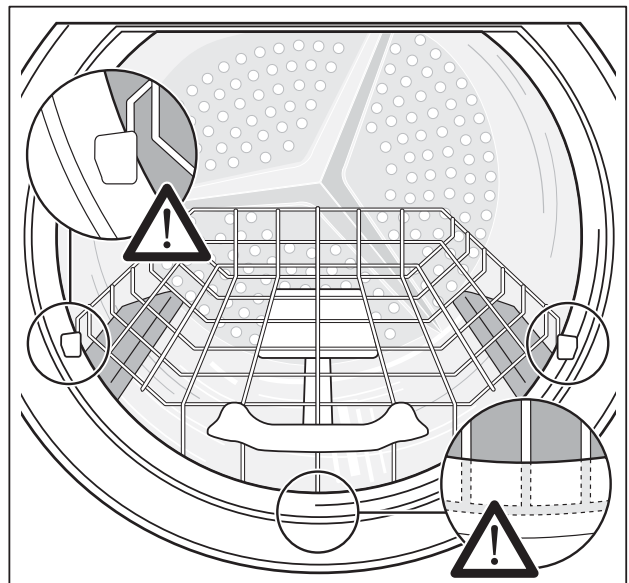

Programme	Application/properties	Care symbols
WOOL	For gentle drying of one woollen garment, washed and spin-dried at 1000 rpm. Programme run times: between 30 and 180 minutes. Max. load: 1 kg	☒
RACK DRY	For gentle drying of one pair of sportshoes, washed and spin-dried at 1000 rpm. Programme run times: between 30 and 180 minutes.	

1. Open the loading door
2. Insert the rack.
3. Place the washing on the rack:
 - Spread the garment out in the rack and roll it up, without squashing or folding it.

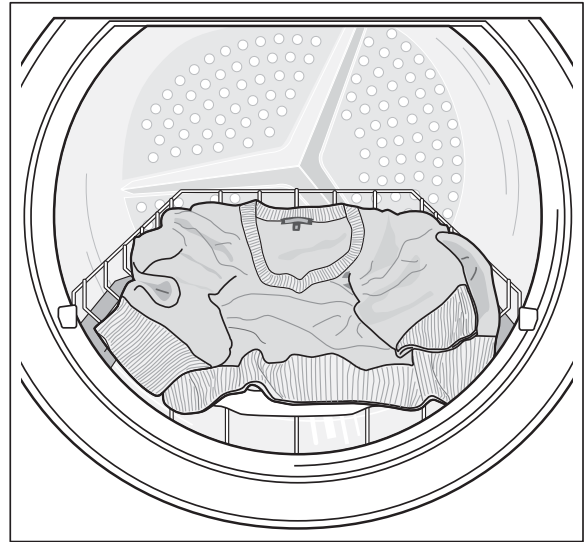

- Place sportshoes on the rack with the board turned up.

Important: Take out the insoles and place them beside the shoes on the rack.

Tie the shoelaces.

Sportshoes mainly made of leather may not be dried with this programme.

4. Select the required programme.
5. Select the required programme run time, settable with an interval of 10 min, from 30 min. up to 180 minutes.
Press the TIME button as many times as necessary until the required programme running time is shown in the display.

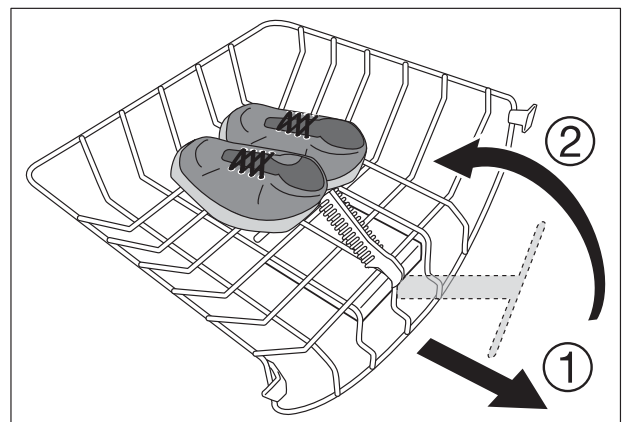

Item	Programme Run Time [Min.]
Light woollen pullovers (approx. 350 g)	90 - 120
Heavy woollen pullovers (approx. 850 g)	120 - 160
Skirts	90 - 120
Pants	90 - 120
Small items, such as gloves	30 - 60
Gym-shoes	120 - 170

6. Press the START/PAUSE button. The programme is started.
7. At the end of the drying programme open the loading door and remove the garments or shoes.
8. Turn the programme selector to OFF.

Hints & Tips on Drying

Before placing articles of laundry in your tumble dryer, check the care labels to ensure they are recommended for tumble drying.

Care Labels you may find on your laundry

 may be tumble dried

 normal drying (high temperature, e.g. cottons)

 delicate drying (low temperature, e.g. synthetics)

 do not tumble dry

Do not overload the appliance.

Here is a list of the approximate weight of some common laundry items.

Sheet	700 to 1000 g
Pillowcase	100 to 200 g
Tablecloth	400 to 500 g
Table Napkin	50 to 100 g
Kitchen Towel	70 to 120 g
Linen Hand Towel	100 to 150 g
Hand Towel	150 to 250 g
Bath Towel	700 to 1000 g
Bathrobe	1000 to 1500 g
Shirt	200 to 300 g
Apron	150 to 200 g

- Always load well spun laundry. The higher the spin speed the lower the electricity consumption and the shorter the drying time.
- **DO NOT** load dripping wet laundry into the dryer. Roll the article in a towel or spin to remove excess water.
- Close poppers and zips and fasten any buttons.
- Sort the laundry. Separate synthetics from cotton/linens, and dry separately.
- Remove the laundry immediately after the programme has finished.
- Use a fabric conditioning sheet to reduce static. We recommend the sheet is pinned to an article of laundry (using a safety pin).
- Mix the load i.e. large and small articles.
- When drying large items such as sheets, we recommend you periodically stop the dryer to redistribute the load.

DO NOT use the tumble dryer to dry the following:

- Articles contaminated with inflammable substances e.g. petrol, cleaning solvents, cooking oil, fats or hair lacquer.
- Woollen and synthetic/wool mixtures unless the item is labelled as suitable for tumble drying.
- Very delicate articles such as silk.
- Very large and bulky items such as duvets or sleeping bags.

Maintenance and Cleaning

You must **disconnect** the appliance from the electricity supply, before you can carry out any cleaning or maintenance work.

External cleaning

Use only soap and water and then dry thoroughly.

Important: do not use methylated spirit, diluents or similar products.

Cleaning the door

Clean periodically the interior part of the door to remove any fluff from the seals around the filter.

Regular cleaning ensures correct drying.

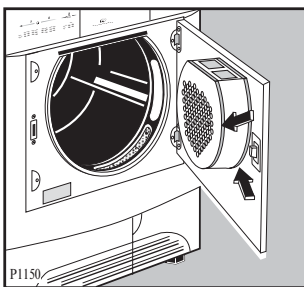

Cleaning the filters

Your dryer will only function well if the filters are clean. The filters collect all the fluff which accumulates during drying and they must therefore be cleaned at the end of each programme, before removing the laundry, with a damp cloth. The FILTER light reminds you to carry out this operation.

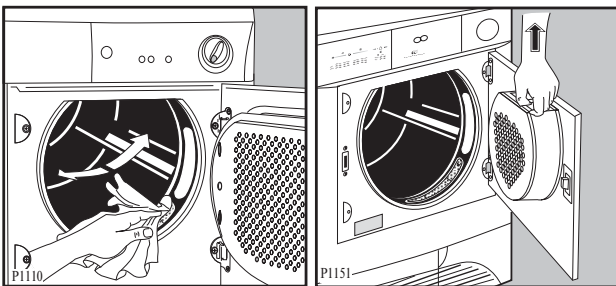

The filter in the inner door must be removed for cleaning. Do not be alarmed by the amount of fluff. It is not due to excessive wear caused by the dryer. All fabric loses fluff when line-drying but it goes un-noticed in the air. In a tumble dryer it simply collects in the filter.

After a while, a whitish coating due to detergent residue on laundry forms on the filters. When this occurs, clean the filters with warm water using a brush. Remove the filter in the door opening as per picture (it can be positioned with the tooth facing to the left or to the right).

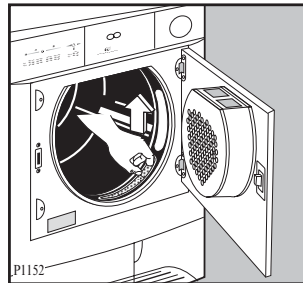

! Do not use the appliance without filters.

Cleaning the condenser unit

Clean the air condenser when the CONDENSER light illuminates.

The condenser is situated at the lower part of the cabinet behind a small door. To open the door, push the catch as per picture.

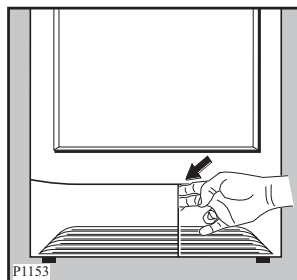

To pull out the condenser, first turn the two red stops downwards as shown below and then remove the condenser unit holding it with the handle.

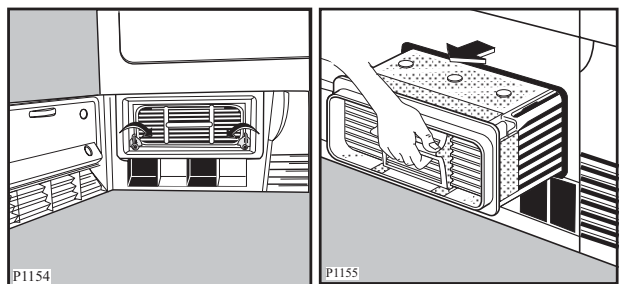

Clean it with a brush and rinse it under the shower if necessary.

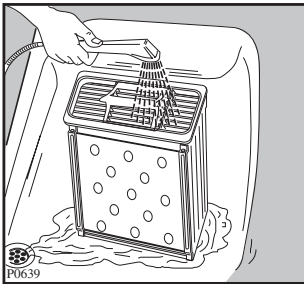

Also clean the outside, removing all fluff.

Clean the rubber seal round the condenser cabinet and in the inner part of the small door with a damp cloth.

Important! Do not use pointed objects or utensils to clean the spaces between the plates, as this could damage the condenser and make it permeable.

Re-fit the condenser, turn the red stops upwards and close the door.



Do not use this appliance if the condenser has not been fitted.

Emptying the water reservoir

Water extracted from the laundry condenses inside the machine and is collected in a reservoir.

The reservoir must be emptied after each drying cycle to ensure efficient operation when the machine is next used. The FULL TANK light reminds you to perform this operation.

Proceed as follows:

- Pull out the reservoir
- Turn it upside down and let water empty
- Re-fit the reservoir

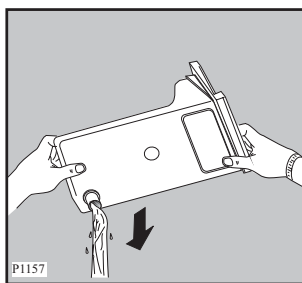
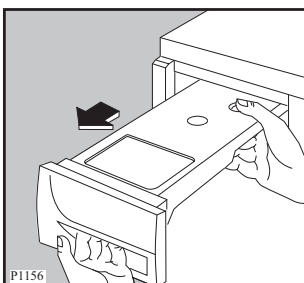

The reservoir must be re-inserted correctly.

If this is not done the pilot light FULL TANK comes on during next drying and the programme stops, leaving the laundry damp. The buzzer will sound.

After inserting the reservoir the START/PAUSE button has to be depressed again to allow the programme to continue.

Handy tip: The condensed water may be used in a steam iron or to top up a battery, etc. In this case it must be filtered (e.g. through a coffee filter).

Cleaning the air intake grill

Using a vacuum cleaner remove the fluff from the air intake grill at the back of the appliance.

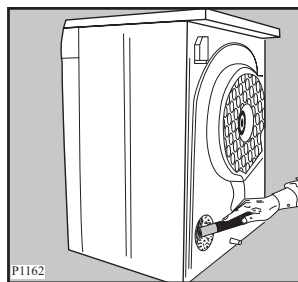

Cleaning the drum

If the laundry is not drying to the level of dryness you have set, either too dry or too damp, we advise you to clean the inside of the drum with a cloth soaked in vinegar.

This will eliminate the slight residues of detergent and softeners used in the washing, or to any residues of lime contained in the water. A build up of these residues will prevent the sensors from correctly measuring the degree of dryness of the laundry.

Adjusting the level of conductivity

Water contains, a variable quantity of limestone and mineral salts of which quantities vary according to geographical locations thus varying its conductivity values.

Relevant variations of the conductivity of the water compared to those prefixed by the factory could slightly influence the residual humidity of the laundry at the end of the cycle.

Your dryer allows you to regulate the sensitivity of the drying sensor based on conductivity values of the water by using the following procedure.

To establish the hardness of your water to correspond with the table opposite please contact your local water authority.

Display	Conductivity degree	Approximative value (µS/cm)
CO _	Low	< 300
CO =	Medium	300 - 600
CO ≡	High	> 600

Simultaneously press down the buttons **Quick** and **Start/Pause** until the previous drying cycle time appears again on the display and the buzzer sounds.

Procedure:

Turn the programme selector dial to switch on the appliance

In selection mode press simultaneously the buttons **Quick** and **Start/Pause** until «CO» appears on the digits.

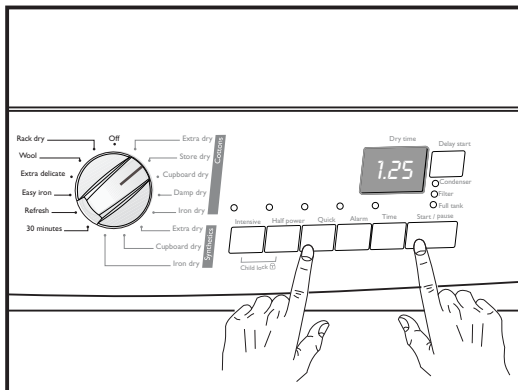

Adjusting the level of conductivity:

Press the button Start /Pause sequentially: the level of conductivity is indicated by the lighting of the horizontal hyphens.

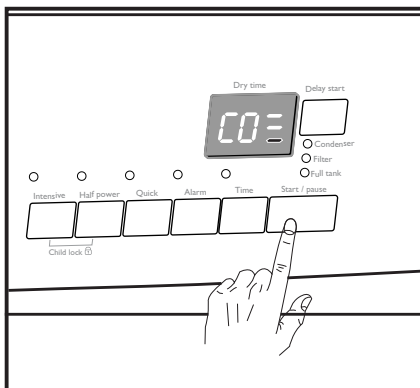

Memorising the new setting:

Something Not Working

If the tumble dryer is not working correctly, please carry out the following checks before contacting your local Service Force agent.

IMPORTANT: if the END light flashes, the buzzer sounds and an alarm code is displayed, switch the machine off and call the telephone number given on page 21.

IMPORTANT: If you call out an engineer to a fault listed below, or to repair a fault caused by incorrect use or installation a charge will be made even if the appliance is under guarantee.

Symptom	Solution
The tumble dryer does not start	<ul style="list-style-type: none"> • The door(s) has (have) not been closed. • The plug is not properly inserted in the power socket. • There is no current at the socket. • The main fuse or the fuse in the plug has blown. • The selector dial is not set correctly. • The water reservoir is full or not properly inserted (the FULL TANK light is on). The programme starts in any case but it stops after approx. 4 minutes. • The START/PAUSE Button has not been depressed. • The DELAY START option has been selected.
Drying takes too long or laundry is not dry enough.	<ul style="list-style-type: none"> • The laundry has not been spun properly. • The filters and/or the condenser are clogged. • The water reservoir is full. • The room temperature is too high. • The selected time or drying cycle was not suitable for the laundry. • The HALF POWER button has been pressed. • There is too much laundry inside the appliance. • The dryer is not correctly installed.
The drum light does not light up:	<ul style="list-style-type: none"> • The Programme/Time selector dial is on position "OFF". • The lamp is defective.

Repairs - After Sales Service

In the unlikely event of your appliance requiring service, or if you wish to purchase spare parts, please contact our extended warranty administrators by telephoning:

0870 010 7887

They will give you details for your local Service Force Centre.

Before calling out an engineer, please ensure you have read the details under the heading "Something Not Working".

When you contact your local Service Force Centre you will need to give the following details:

1. Your name, address and post code
2. Your telephone number
3. Clear and concise details of fault
4. The purchase date found on your receipt.
5. The model and serial number of the appliance (found on the rating plate - see picture on page 5)

So that you always have these numbers at hand, we recommend you to make a note of them here:

Mod. :

PNC :

S.N. :

Your dryer is covered by a 3 year parts and labour guarantee (see separate details given at point of sale). Please retain your purchase receipt safely for the service engineer to verify the purchase details.

Spare parts

Always insist on genuine spare parts.

An authorised service engineer should service this product, and only genuine spare parts should be used. Under no circumstances should you attempt to repair the machine yourself. Repairs carried out by inexperienced persons may cause injury or serious malfunctioning. Contact your local Service Force Centre.

John Lewis Partnership
171 Victoria Street
London SW1E 5NN

www.johnlewis.com

Free Manuals Download Website

<http://myh66.com>

<http://usermanuals.us>

<http://www.somanuals.com>

<http://www.4manuals.cc>

<http://www.manual-lib.com>

<http://www.404manual.com>

<http://www.luxmanual.com>

<http://aubethermostatmanual.com>

Golf course search by state

<http://golfingnear.com>

Email search by domain

<http://emailbydomain.com>

Auto manuals search

<http://auto.somanuals.com>

TV manuals search

<http://tv.somanuals.com>