

# Fridge Freezer

JLP-Model No. JLFSWH2002 - JLFSBK2001



User guide

**John Lewis**



# Contents

Contents	3	Changing door opening direction	14
Introduction	4	Removing the fridge & freezer door	14
Safety is important	4	Reverse the door accessories	14
In the box	4	Replacing the fridge & freeaer door	15
Safety information	5	Disposal and Guarantee	16
Important safety information	5	Disposal	16
Warnings	5	Guarantee	16
Cautions	6	Troubleshooting	17
Ecological hints	6	Troubleshooting	17
Environmental information	6	Repairs - after sales service	20
Electrical information	7	Spare parts	20
Mains supply	7	Specification	21
Parts identification	8		
Control panel	8		
Operation	9		
Temperature control	9		
Setting the fridge temperature	9		
Setting the freezer temperature	9		
How to use the fridge storage areas	10		
Food storage tips	11		
Care, Cleaning and Servicing	12		
Care and Cleaning	12		
Fridge and freezer containers	12		
Upper door compartment	12		
Mid and lower door compartment	12		
Fridge shelves	12		
Vegetable case and freezer drawer	12		
Servicing	12		
Installation	13		
Positioning	13		
Leveling	13		
Preparation for installation	13		

# Introduction

Thank you for purchasing this fridge freezer.

Please take time to read these instructions and retain for future reference.

## Safety is important

---

To ensure your safety and the safety of others, please read the Safety information **before** you operate this product.

Keep this information in a safe place for future reference.

## In the box

---

You will find the following:

- Fridge freezer
- User guide
- Egg case
- Ice storage case with ice tray

**Note:** If any of the items listed are damaged or missing, please contact your local John Lewis branch.

# Safety information

## Important safety instructions - read carefully before use

Take note of the following safety information which appears on the back of this fridge freezer:



**Warning! To prevent fire or shock hazard, do not expose this fridge freezer to rain or moisture.**



**Warning! Always remove the mains plug from the wall socket when not in use or before any service operation.**



**Warning! There are no user serviceable parts on this fridge freezer. Refer servicing to qualified service personnel.**



This symbol indicates that there are important operating and maintenance instructions in the literature accompanying this fridge freezer.



This symbol indicates that dangerous voltages constituting a risk of electric shock are present within this fridge freezer.

## Important safety information

It is most important that this user guide and the installation guide should be retained with the fridge freezer for future reference. Should the fridge freezer be sold or transferred to another owner, or should you move house and leave the appliance, always ensure that the guides are supplied with the fridge freezer in order that the new owner can get to know the functionality and the relevant warnings.

These warnings have been provided in the interest of safety. You MUST read them carefully before installation or use. If you are unsure of the meanings of these warnings contact the John Lewis branch from which you purchased the fridge freezer.

To avoid accidents to property or people it is important to follow the instructions given. Failure to do so removes any liability from John Lewis.

## Warnings

- This fridge freezer is designed to be operated by adults. Children should not be allowed to tamper with the controls or play with the fridge freezer.
- Keep all packaging well away from children. There is risk of suffocation.
- Never let the power cord be crushed by the fridge freezer itself or other (heavy) objects. Never bend power cord excessively.
- Never hold the power cord or plug with wet hands.
- Never use a damaged power cord or plug, or loose main socket.
- Never let the power cord touch or pass over heating appliances.
- Do not use other electrical appliances inside the appliance.
- Containers with flammable gases or liquids can leak at low temperatures. Do not store any containers with flammable materials, such as spray cans, fire extinguisher refill cartridges etc.. in the fridge freezer or the vicinity of the fridge freezer or any other appliance.
- Frozen food should not be refrozen once it has thawed out.
- The small quantity of refrigerant used in this appliance is eco-friendly R600a (an isobutene) and is nevertheless both inflammable / explosive if ignited in enclosed conditions.
- Never insert fingers or hands into the bottom of the fridge freezer, especially into the bottom back.
- When moving the fridge freezer (horizontally or tilted), two people are required (one to hold the top back handles, the other to hold the lifting areas at the bottom). If other parts are gripped, it is very dangerous and likely to slip.

- When the fridge freezer is to be scrapped, cut off the electrical supply cable and destroy the plug with the remaining cable. Disable the door catch in order to prevent children from becoming trapped inside while playing. A cut off plug inserted into a 13 amp socket is a serious safety (shock) hazard. Please ensure the cut off plug is disposed of safely.

## Cautions

- This fridge freezer is designed for domestic use only, specifically for the storage of edible foodstuffs.
- Do not place carbonated or fizzy drinks in the freezer compartment.
- Do not remove items from the freezer if your hands are damp/wet, as this could cause skin abrasions or frost/freezer burns.
- Because of the very low temperatures in the freezer some foods e.g. ice lollies could cause frost burns if consumed immediately.
- Bottles and cans must not be placed in the freezer compartment as they can burst as the contents freeze.
- Store pre-packed frozen foods in accordance with the frozen foods instructions and use by date.
- Do not store medicine, academic research samples which require strict temperature control in the fridge freezer.
- When cleaning, removing spillages (liquids or frozen food) or removing the ice tray do not use any implements that are hard, sharp or pointed as they may cause damage to the appliance.
- Keep ventilation openings in the appliance enclosure or in the built-in structure, clear of obstruction.
- Do not install the fridge freezer on a wet floor or in a place with a high humidity / moisture content.
- Locate the fridge freezer in a well ventilated room and make sure that any air openings of the appliance are not obstructed.
- Pack all foods into airtight packages before placing them into the freezer compartment.
- Food which is to be frozen (when cool) should be placed in the fridge compartment before being transferred to the freezer.
- Try to avoid keeping the doors open for long periods or opening the doors too frequently as warm air will enter the cabinet and cause the compressor to switch on unnecessarily often.
- Ensure there are no obstructions preventing the doors from closing properly.

## Ecological hints

To save water and energy and help protect the environment, we recommend that you follow these hints:

- Do not install the appliance close to sources of heat such as a boiler or radiator.



## Environmental information

- RoHS (Directive 2002/95/EC) compliant:  
This fridge freezer is environmentally sound and sustainable free from Pb, Cd, Cr+6, Hg PBBs and PBDEs restricted in accordance with the directive.
- After installation, please dispose of the packaging with due regard to safety and the environment.
- Materials marked with the  are recyclable.
- Avoid damaging the cooling unit, especially at the rear, near the heat exchanger.
- This fridge freezer does not contain gases which could damage the ozone layer, in either its refrigerant circuit or insulation materials.
- Please dispose of this fridge freezer in accordance with the disposal instruction on page 16. By ensuring this product is disposed of correctly, you will help prevent potential negative consequences for the environment and human health, which could otherwise be caused by inappropriate waste handling of this product.

## Electrical information

---

### Mains supply

---



**Warning! This fridge freezer MUST BE EARTHED.**

---

Should the power supply cable need to be replaced, this must be carried out by an approved service engineer. John Lewis declines any liability should this safety measure not be observed.

Before switching on, make sure the electricity supply voltage is the same as that indicated on the fridge freezer's rating plate.

The fridge freezer is supplied with a 13 amp plug. In the event of having to change the fuse in the plug supplied, a 13 amp ASTA approved BS 1363/A fuse must be used.

---



**Warning! The appliance should not be connected to the electrical supply by means of an extension cable.**

---

# Parts identification

## Control panel

---

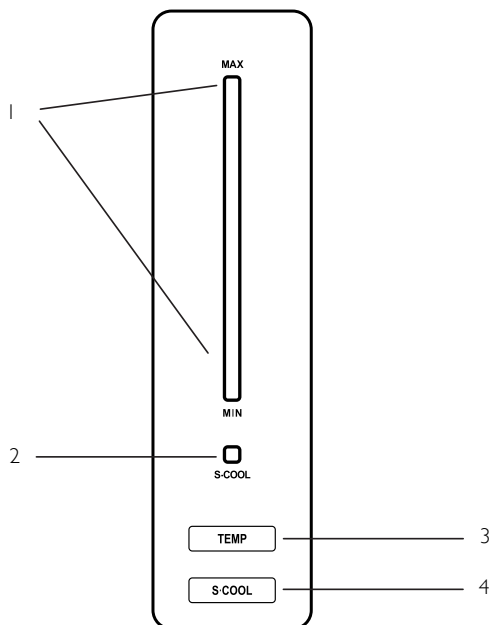

- |   |  |   |                                   |
|---|--|---|-----------------------------------|
| 1 | Indicator display - Fridge temperature | 3 | Fridge temperature control button |
| 2 | Indicator display - Fridge supercool   | 4 | Fridge supercool button           |

## Freezer temperature control

---

- Control lever switch is at the rear side of the top drawer right hand corner.

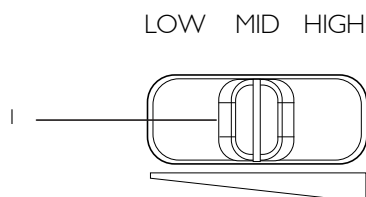

- |   |  |
|---|--|
| 1 | Temperature control lever switch - Freezer compartment |
|---|--|



# Operation

## Notes:

- Before connecting the mains plug, wait at least 2 hours after delivery.
- Food can be stored after 3 to 4 hours of cooling.
- Alarm function:
  - In case fridge doors are left open for more than a minute, the door alarm rings for 5 minutes periods with a one minute interval.

## Temperature control

When the fridge freezer is first plugged in, the default temperature settings for the fridge and freezer are mid range.

---

### Setting the fridge temperature

Repeatedly press the **TEMP** button until the desired temperature is selected. The temperature sequence shown below:

**MID** › **MID-MAX** › **MAX** › **MIN** › **MID-MIN**

If you require faster cooling, press the **S-COOL** button and the indicator will flicker with beep. **Supercool** will last about 40 minutes and return to normal.

Temperature guideline for each sequence is as below:

MID: 3°C, MID-MAX: 1°C, MAX: -1°C,  
MIN: 5°C, MID-MIN: 4°C

### Setting the freezer temperature

Using control lever switch in the freezer compartment, different temperature can be selected as below:

**LOW** ‹ **MID** ‹ **HIGH**



**Caution - Food in the fridge can be frozen if the ambient temperature of the fridge is below 5°C.**

---

## How to use the fridge storage areas

The following list is a suggestion of the usage for each of the compartments within the fridge:

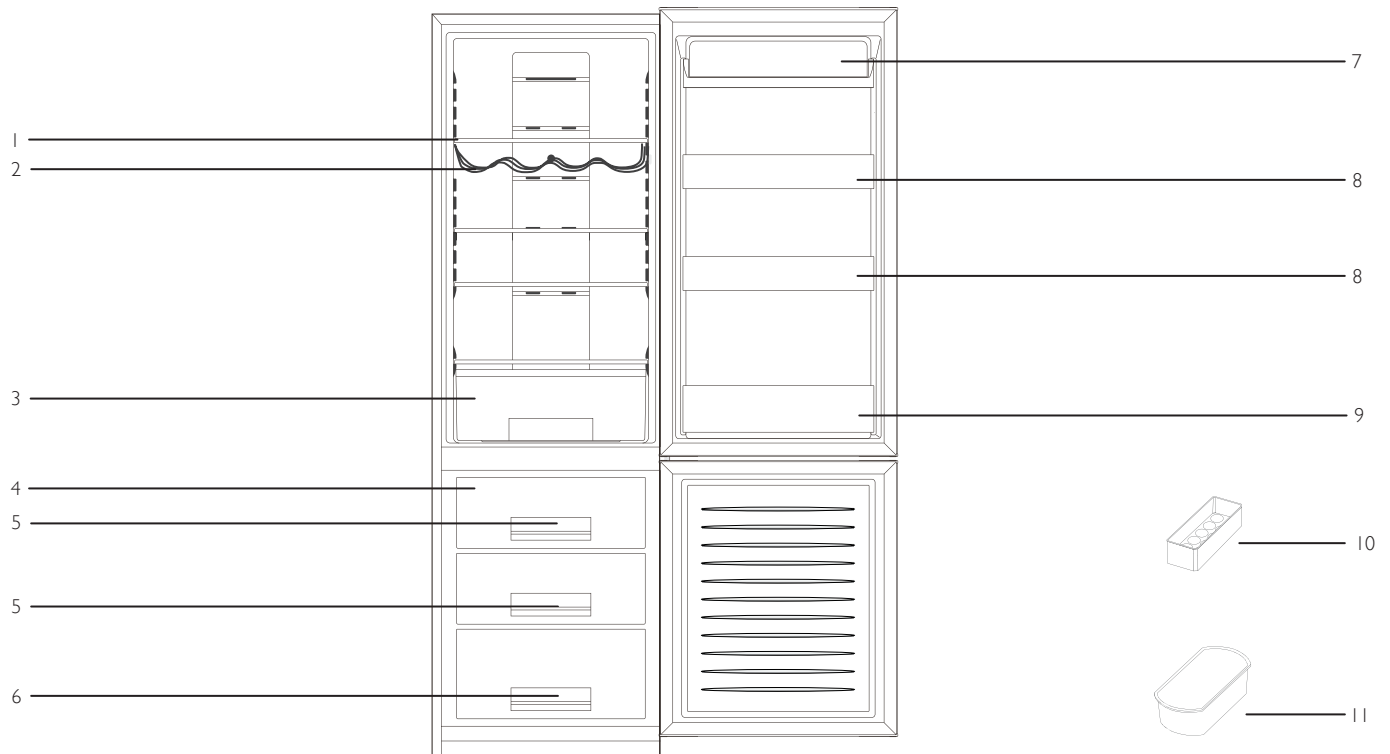

- |   |  |    |   |
|---|--|----|---|
| 1 | Adjustable glass shelf - for storing commonly access foods                                 | 7  | Upper door compartments – for storing butter and cheese   |
| 2 | Wine rack  | 8  | Mid door compartments – for storing smaller items of food |
| 3 | Vegetable case   | 9  | Lower door compartments – for storing big bottled drinks  |
| 4 | Place the ice storage case(11) in the left side of the top freezer drawer to make ice fast | 10 | Egg case  |
| 5 | Freezer drawer (type A: deeper)  | 11 | Ice storage case with ice tray                            |
| 6 | Freezer drawer (type B: taller)  |    |   |

## Food storage tips



Wash you food before storing.

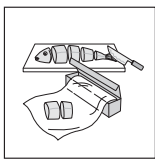

Divide and separate food into smaller pieces.

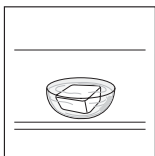

Place watery food or food with moisture on the front shelves close to the edges of the fridge compartment. If they are placed close to the cold air spout, they can be frozen.



Warm or hot food should be cooled down before storing to reduce power consumption and to enhance refrigeration performance.

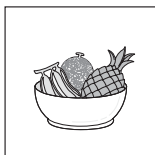

Be careful when storing food such tropical fruit e.g. bananas, pineapples, tomatoes, for they can easily deteriorate in lower temperatures.

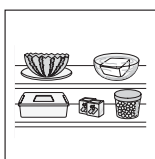

Keep as much space as possible between the items of food. If you pack the food too tight or too close, cold air circulation is hindered, resulting in poor refrigeration.

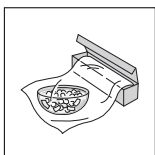

Never forget to cover or wrap food to prevent odours.

# Care, cleaning and servicing

Switch off and unplug the fridge freezer before carrying out any cleaning or maintenance work.

## Care and cleaning

---

Clean the interior exterior casing using a cloth with water and mild (neutral) Detergent.

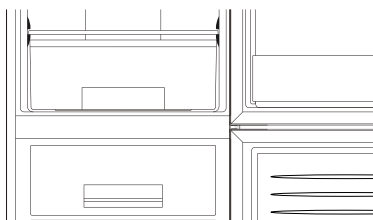

Clean the grill at the back of the fridge freezer at least once a year using the nozzle attachment on a vacuum cleaner.

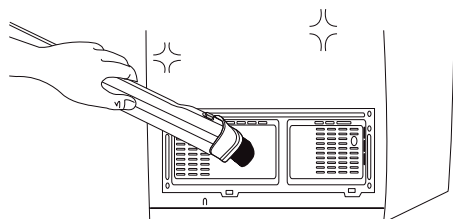

## Fridge and freezer containers

Remove a container by withdrawing it as far as it will go and the lifting up the front and then and fully removing it.

Replace the container by locating the rear lugs and the pushing it all the way back in.

## Upper door compartment

Open the cover a little, hold both ends and push lift to remove the compartment cover, and then hold both ends and push upward to remove the compartment.

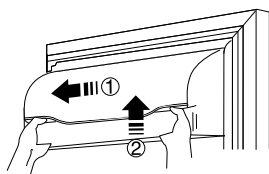

## Mid and lower door compartment

Remove a door compartment by holding both ends and pulling it up.

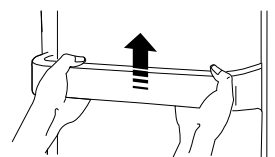

## Fridge shelves

Open the fridge door fully, and remove a shelf by lifting it up at the rear, pulling it forward.

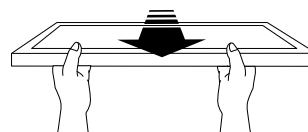

## Vegetable case and freezer drawers

Open the fridge door fully, and remove a shelf by lifting it up at the rear, pulling it forward.

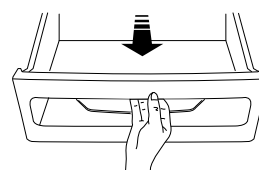

## Servicing

---

This fridge freezer should only be serviced by an authorised service engineer, and only genuine spare parts should be used.

Under no circumstances should you attempt to repair the fridge freezer yourself. Repairs carried out by inexperienced person may cause injury or serious malfunction.

# Installation

## Positioning

---

Before unpacking your fridge freezer, be aware of the following points:

Find a suitable location for the fridge freezer; it should be positioned as follows:

- In a dry room that can be ventilated.
- Out of direct sun light.
- Away from any heat source, e.g. stove or radiator (if this is unavoidable, a suitable heat insulator should be used (not supplied).
- A minimum gap of 25 mm from another fridge or freezer.
- A minimum gap of 50 mm above the fridge freezer for ventilation.
- A minimum gap of 50 mm from the back wall.
- On a solid floor that will not sag under the weight of the fridge freezer.

Ensure the fridge freezer should be installed in a location where the ambient temperature corresponds to the climate classification for which the fridge freezer is designed

Climate Classification	Ambient Operating Temp.
SN	+10 to +32°C
N	+16 to +32°C
ST	+16 to +38°C
T	+16 to +43°C

Climate classification can be found on the rating plate at the inside of the fridge right hand wall or end of this guide.

## Leveling

---

Level the fridge freezer by turning the 2 adjustable feet at the front of the appliance. The fridge freezer must be level in order to prevent vibration and excessive noise and to ensure the doors shut properly.

## Preparing the fridge freezer

---

To prepare your fridge freezer for use and check it is running correctly, take the following steps:

- Install all shelves and compartments in the correct positions which removed or positioned temporarily during transport.
- Clean the fridge freezer and accessories to remove any dust that accumulated during packing, shipping and unpacking.
- Allow the appliance to stand for 2 hours before plugging in.
- The interior light should be turned on when the fridge door is open once plugged in.
- Store food once the temperature of fridge freezer is sufficiently low. It takes for a few hours to reach the proper temperature after starting the fridge freezer.
- A whooshing noise can sometimes be heard when first installed. Don't worry the cases will soon settle.

# Changing door opening direction

If you wish to change the opening direction of the doors, proceed as follows:

## Removing the fridge & freezer door

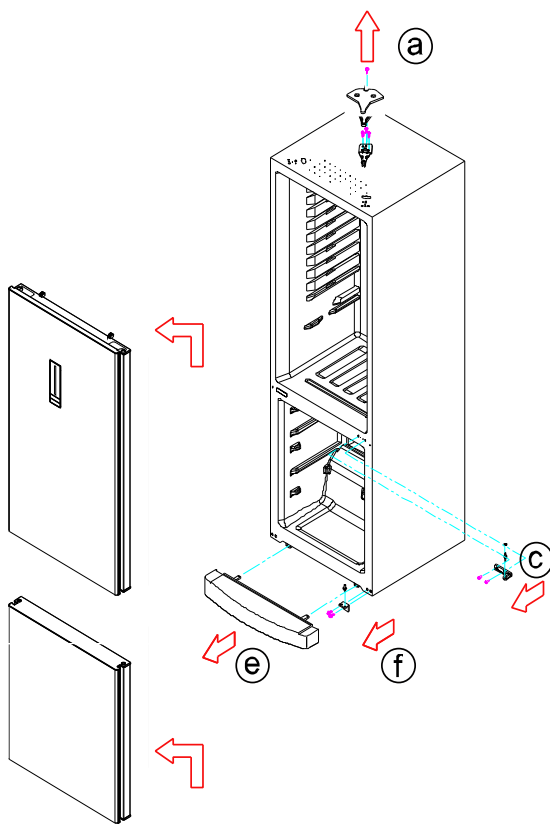

- a. Remove 'Top Cover Hinge' and 'Top Hinge'.
- b. Carefully remove 'Fridge Door'.
- c. Remove 'Middle Hinge'.
- d. Carefully remove 'Freezer Door'.
- e. Remove 'Cover Bracket'.
- f. Remove 'Under Hinge'.

## Reverse the door accessories

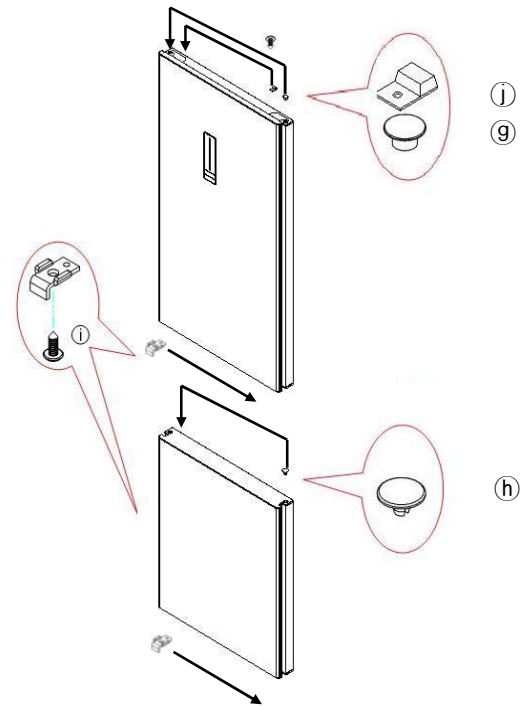

- g. Reverse the position of 'Cover Bushing of Fridge Door'.
  - Unscrew and remove 'Harness Cover'.
  - Take out 'Left Door Harness' and assemble 'Harness Cover' on 'Right Door Harness'.
- h. Reverse the position of 'Cover Bushing Freezer Door'.
- i. Reverse the position of 'Door Stoppers'.
- j. Reverse the position of 'Button Switch'.
  - Unscrew 'Button Switch'.

## Replacing the fridge & freezer door

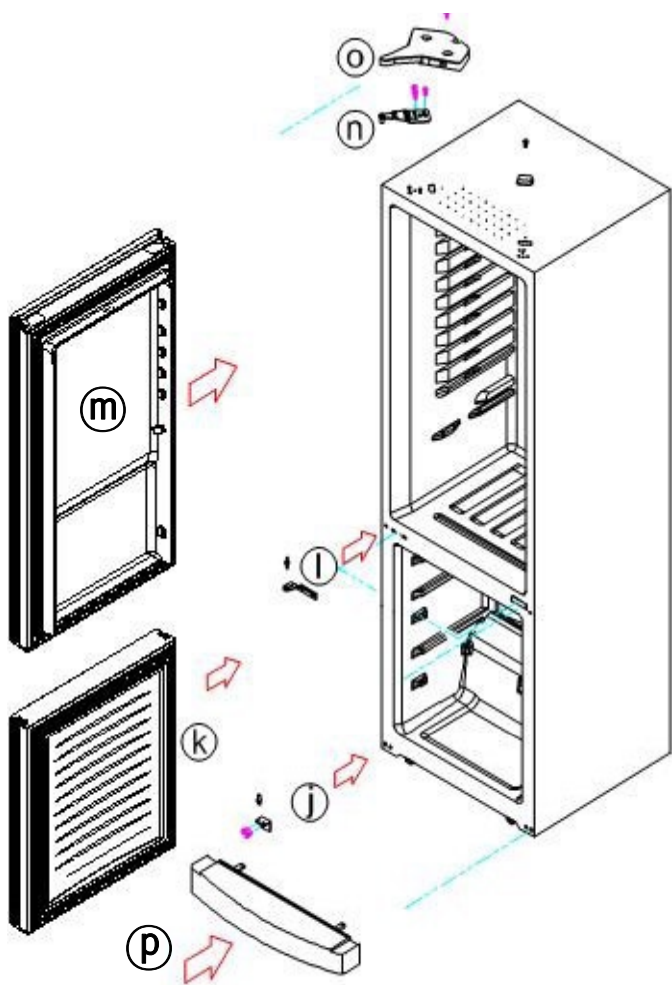

- j. Assemble the 'Under Hinge' on the left.
- k. Attach the 'Freezer Door' to Cabinet.
- l. Assemble the 'Middle Hinge' on the left.
- m. Attach the 'Fridge Door' to Cabinet.  
(Be careful not to drop door.)
- n. Assemble 'Top Hinge' and connect the wires.
- o. Connect the 'Door Switch' wire housing.  
Assemble the 'Door Switch' on the other side.
- p. Assemble the 'Cover Bracket'.

# Disposal and guarantee

## Disposal

---

This symbol  on the product or on its packaging indicates that this product may not be treated as household waste. Instead it shall be handed over to the applicable collection point for the recycling of electrical and electronic equipment. By ensuring this product is disposed of correctly, you will help prevent potential negative consequences for the environment and human health, which could otherwise be caused by inappropriate waste handling of this product. For more detailed information about recycling of this product, please contact your local council office, your household waste disposal service or the John Lewis branch where you purchased the product.

## Guarantee

---

Your John Lewis Fridge Freezer is covered by a three year parts and labour guarantee. This means that if Fridge Freezer develops a fault during the guarantee period we arrange a repair free of charge. Your original receipt acts as your guarantee so please make sure that you retain it throughout the guarantee period.

Please note that this guarantee does not cover you against faults caused by accidental damage or misuse.



# Troubleshooting

To assist in locating possible faults use the help guide below:

Troubleshooting		
Problem	Cause	Correction
<b>Running of fridge</b>		
Compressor does not run.	Fridge is in defrost cycle.	This is normal for a fully automatic defrost fridge. The defrost cycle occurs periodically, lasting about 30 minutes.
	The mains plug is disconnected.	Ensure mains plug is tightly pushed into outlet.
	House fuse blown or a tripped circuit breaker.	Check/replace fuse with a 15 amp time-delay fuse. Reset circuit breaker.
	Power cut.	Check house lights, if these are not working, Call your local electric company.
Fridge freezer runs too often or for too long.	The room or outside temperature is hot.	It is normal for the fridge freezer to work longer under these conditions.
	Fridge freezer has recently been disconnected for a period of time.	It takes 8-12 hours for the Fridge freezer to get down to it operating temperature.
	The doors are opened too frequently or for too long.	Warm air entering the fridge causes it to run for longer. Open the doors less often.
	Fridge/freezer door maybe slightly open.	Ensure fridge freezer is level. Keep food and containers from blocking door. See the problem column for opening/closing of doors/drawers.
	The fridge freezer controls are set too cold.	Set fridge freezer controls to warmer setting until fridge freezer temperature is satisfactory. Allow 24 hours for temperature to stabilize.
	Fridge / freezer door seals are dirty, worn, cracked, or poorly fitted.	Clean or change the door seal(s). Leaks in door seal will cause fridge to run longer in order to maintain desired temperatures.
Compressor goes off and on frequently.	Electronic control system keeps the fridge at a constant temperature.	This is normal. Fridge freezers go on and off to keep temperature constant.
<b>Temperatures are too cold</b>		
Freezer temperature too cold. Fridge temperature is satisfactory.	Freezer control is set too cold.	Set the freezer control to a warmer setting. Allow 24 hours for the temperature to stabilise.
Fridge temperature too cold. Freezer temperature is satisfactory.	Fridge control is set too cold.	Set fridge control to a warmer setting. Allow 24 hours for the temperature to stabilise.
Food stored in the fridge drawers freezes.	Fridge control is set too cold. Fridge is installed in an environment where the temperature drops below 5 °C.	See solution above. See installation section.

Troubleshooting (continued)		
<b>Temperatures are too warm</b>		
Fridge/freezer temperature is too warm.	Doors are opened too frequently or for too long.	Warm air enters the fridge freezer whenever one of the doors is opened. Open the door less often.
	Door is slightly open.	See problem column for the opening/closing of doors/drawers.
Freezer temperature is too warm. Fridge temperature is satisfactory.	Freezer control is set too warm.	Set freezer control to a colder setting. Allow 24 hours for temperature to stabilise.
Fridge temperature is too warm. Freezer temperature is satisfactory.	Fridge control is set too warm.	Set fridge control to a colder setting. Allow 24 hours for temperature to stabilise.
<b>Water/moisture/frost inside fridge</b>		
Moisture collects on inside of fridge walls.	Weather is hot and humid.	The rate of frost build up and internal sweating increases.
	A door is slightly open.	See problem column for the opening/closing of doors/drawers.
	Door is opened too often or too long.	Open door less often to allow internal temperature to stabilise.
Water collects on bottom side of drawer cover.	Water collects on bottom side of drawer cover.	It is not unusual to have moisture on the bottom side of the cover.
Moisture collects in bottom of drawer.	Washed vegetables and fruit drain while in the drawer.	Dry items before putting them in the drawer. Water collecting on bottom of drawer is normal.
	Fruits and vegetables are kept past their prime.	Routinely clean out old fruits and vegetable especially if they begin to break down.
<b>Water/moisture/frost outside Fridge Freezer</b>		
Moisture collects on outside of fridge freezer or between doors.	Weather is humid.	This is normal in humid weather. When humidity is lower, the moisture should disappear.
	Door is slightly open, causing cold air from inside fridge to meet warm air from outside.	See problem column for the opening/closing of doors/drawers.

Troubleshooting (continued)		
<b>Odours in fridge</b>		
Interior is dirty.	Interior needs to be cleaned. Food with strong odours is in fridge.	See care and cleaning chart in care & cleaning. Cover food tightly.
<b>Opening/closing of doors/drawers</b>		
Door(s) will not close.	Door was closed too hard, causing other door to open slightly.	Close doors gently.
	Fridge is not level. It rocks on the floor when moved slightly.	Ensure floor is level and solid, and can adequately support the fridge. Contact a carpenter to correct a sagging or sloping
	Fridge freezer is touching a wall or cabinet.	Ensure floor is level and solid, and can adequately support the fridge freezer. Contact a carpenter to correct a sagging or sloping floor.
Drawers are difficult to move.	Food is touching shelf on top of drawer.	Keep less food in drawer.
	Track that drawers slide on is dirty.	Clean drawer, rollers, and track. See care and cleaning chart in care and cleaning section.
<b>Lights not working</b>		
A light is not working.	Light bulb / LED has failed.	Call your service agent to replace the failed bulb /LED.
	No electric current is reaching fridge freezer.	See problem column for the running of fridge freezer.
	Control system has disabled lights because one or both doors were left open too long.	Close and reopen door(s) to enable lights.

If none of the suggestions seem to work, please contact your local John Lewis branch or our warranty administrators(See Repairs page). Never attempt to repair the fridge freezer yourself.

**Note:** The fridge freezer must only be repaired by a qualified registered service person.

# Repairs - after sales service

Your fridge freezer comes with a free three year warranty. If it is not working correctly; consult the troubleshooting section within this User Guide. If a fault occurs which you can not resolve through following the advice and information contained within this User Guide, the next step is to contact our warranty administrators on 0844 871 7771.

They will give you details for your local service engineer.

When you contact your local service engineer you will need to give the following details:

- Your name, address and post code
- Your telephone number
- Clear and concise details of fault
- The purchase date as found on your receipt
- The model and serial number of the fridge freezer. So that you always have these numbers at hand, we recommend you make a note of them here:

Mod : .....

S.N : .....

**Note:** If you call out an engineer to a fault or to repair a fault caused by incorrect use or installation, a charge will be made even if the fridge freezer is under guarantee.

## Spare parts



**Cautions: Always insist on genuine spare parts.**

An authorised service engineer should service this fridge freezer, and only genuine spare parts should be used.

Under no circumstances should you attempt to repair the fridge freezer yourself. Repairs carried out by inexperienced persons may cause injury or serious malfunctioning.

Contact your local John Lewis branch.

## Specification

---

Specifications of the fridge freezer that you have just purchased may vary from the information in this table due to technical innovations.

---

**Dimensions** 595 mm wide x 651 mm deep x 1898 mm high

---

**Net Weight** 80 Kg (boxed), 72 Kg (product)

---

**Net Fridge Capacity** 242 litres

---

**Net Freezer Capacity** 90 litres

---

**Ambient Operating Temperature** 16 - 43 °C (Climate category: T)

---

**Energy Rating** A+

---

## Note

---

## Note

---

**John Lewis Partnership**

171 Victoria Street  
London SW1E 5NN  
[www.johnlewis.com](http://www.johnlewis.com)



## Free Manuals Download Website

<http://myh66.com>

<http://usermanuals.us>

<http://www.somanuals.com>

<http://www.4manuals.cc>

<http://www.manual-lib.com>

<http://www.404manual.com>

<http://www.luxmanual.com>

<http://aubethermostatmanual.com>

Golf course search by state

<http://golfingnear.com>

Email search by domain

<http://emailbydomain.com>

Auto manuals search

<http://auto.somanuals.com>

TV manuals search

<http://tv.somanuals.com>