

# JLWM 1406

## 1400 spin washing machine

### Instruction manual

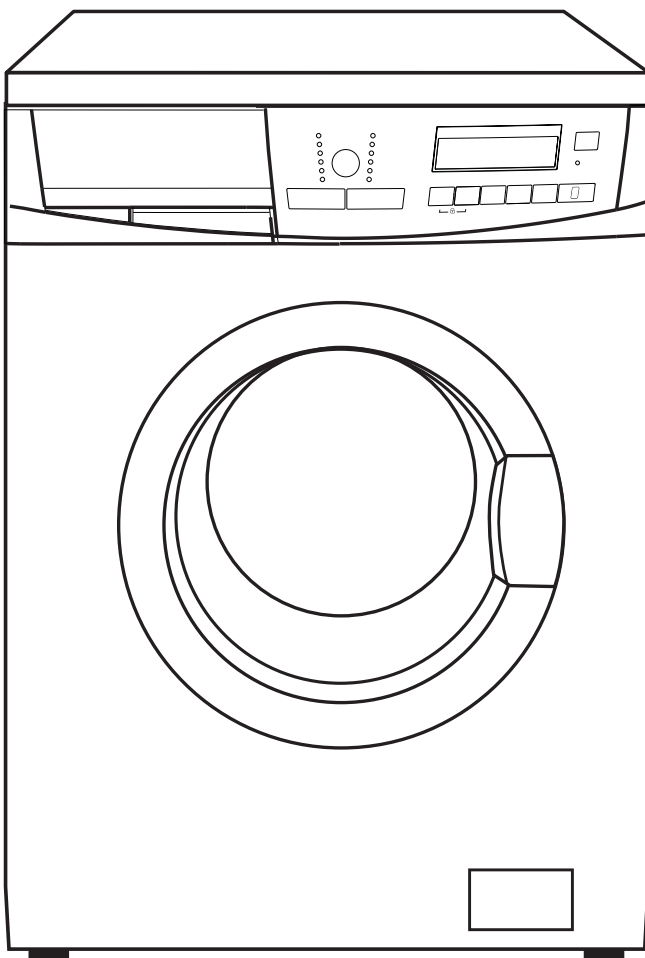

**John Lewis**



# Important safety information

It is most important that this instruction book should be retained with the appliance for future reference. Should the appliance be sold or transferred to another owner, or should you move house and leave the appliance, always ensure that the book is supplied with the appliance in order that the new owner can get to know the functioning of the appliance and the relevant warnings.

These warnings have been provided in the interest of safety. You **MUST** read them carefully before use or installation by a qualified person.

If you are unsure of the meanings of these warnings contact the John Lewis branch from which you purchased the appliance.

## Installation

- This appliance is heavy. Care should be taken when moving it.
- It is dangerous to alter the specifications or attempt to modify this product in any way.
- All packing and transit bolts must be removed before use. Serious damage can occur to the product and to property if this is not adhered to. See relevant section in instructions.
- Care must be taken to ensure that the appliance does not stand on the electrical supply cable.
- If the machine is situated on a carpeted floor, please adjust the feet in order to allow air to circulate freely.
- Always be sure, that there is no water leakage from hoses and their connections after the installation.

## Child safety

- This appliance is designed to be operated by adults. Children should not be allowed to tamper with the controls or play with the product.
- This appliance is not intended for use by person (including children) with reduced physical sensory or mental capabilities or lack of experience and knowledge unless they have been given supervision or instruction concerning use of the appliance by a person responsible for their safety.
- Pets and children have been known to climb into washing machines. Please check your drum before use.
- The glass door becomes very hot during the washing cycle. Keep children away from the vicinity of the appliance whilst it is in operation.
- Keep all packaging well away from children.
- Keep all detergents in a safe place out of children's reach.

- When the appliance is to be scrapped, cut off the power supply cable and destroy the plug with the remaining cable. Disable the door catch in order to prevent children from becoming trapped inside while playing .

## Use

- Always unplug the appliance and turn off the water supply after use.
- Do not overload the appliance. See relevant section in the instruction book.
- Only wash fabrics which are designed to be machine washed. If in doubt, consult the care label on the clothes.
- Before washing, ensure that all pockets are empty and buttons and zips are fastened. Avoid washing frayed or torn articles and treat stains such as paint, ink, rust, and grass before washing. Underwired bras must **NOT** be machine washed.
- Any objects such as coins, safety pins, nails, screws, stones or any other hard, sharp material can cause extensive damage and must not be placed into the machine.
- Garments which have been in contact with volatile petroleum products should not be machine washed. If volatile cleaning fluids are used, care should be taken to ensure that the fluid is removed from the garment before placing in the machine.
- Wash small items such as socks, laces, washable belts etc in a washing bag or pillow case as it is possible for such items to slip down between the tub and the inner drum.
- Only use the advised quantities of fabric softener. Damage to the fabric can ensue if you over-fill. Refer to the manufacturer's recommendations of quantities.

- As some duvets and eiderdowns should be washed in large commercial machines because of their bulk, please check with the manufacturer of the item before washing in a domestic machine.

## Maintenance and cleaning

- For information on maintenance and cleaning your washing machine see pages 23 - 24 of this instruction manual.

## Service

- This product should only be repaired or serviced by an authorised Service Engineer and only genuine approved spare parts should be used.

## Ecological hints

To save water and energy and help protect the environment, we recommend that you follow these hints:

- Normally soiled laundry may be washed without prewashing in order to save detergent, water and time (the environment is protected too!).
- The machine works more economically if it is fully loaded.
- With adequate pre-treatment, stains and limited soiling can be removed; the laundry can then be washed at a lower temperature.
- Measure out detergent according to the water hardness, the degree of soiling and the quantity of laundry being washed.

## Environmental information

- After unpacking please dispose of packaging with due regard to safety and the environment.
- Materials marked with the symbol  are recyclable.
- Check with your local Council or to see if there are facilities in your area for recycling this appliance.

---

### WARNING:



**A cut off plug inserted into a 13 amp socket is a serious safety (shock) hazard. Ensure that the cut off plug is disposed of safely.**

---

The symbol  on the product or on its packaging indicates that this product may not be treated as household waste. Instead it should be taken to the appropriate collection point for the recycling of electrical and electronic equipment. By ensuring this product is disposed of correctly, you will help prevent potential negative consequences for the environment and human health, which could otherwise be caused by inappropriate waste handling of this product.

For more detailed information about recycling of this product, please contact your local council, your household waste disposal service or the shop where you purchased the product.

# Contents

## For the User

<b>Important Safety Information</b>	<b>2-3</b>
Installation	2
Child safety	2
Use	2
Maintenance and cleaning	3
Service	3
Ecological hints	3
Environmental information	3
<b>The Control Panel</b>	<b>5-9</b>
Display and buttons	5
<b>Using the washing machine</b>	<b>10-11</b>
Load the laundry	10
Measure out the detergent	10
Measure out the fabric softener	10
Switch the machine on and select the desired programme	10
Select the temperature and the spin speed	10
Select the desired options	10
Select the Extra rinse option	10
Select the Delay start	10
Start the programme	10
Programme correction	11
Cancel a programme or switch the machine off	11
How to interrupt a programme	11
How to open the door after a programme has started	11
End of programme	11
<b>Hints &amp; Tips on Washing</b>	<b>12</b>
<b>Wash Care Symbols</b>	<b>13</b>
<b>Washing Programmes</b>	<b>14-16</b>

<b>Maintenance and Cleaning</b>	<b>17-20</b>
Descaling	17
After each wash	17
Maintenance Wash	17
External cleaning	17
Cleaning the dispenser drawer	17
Cleaning the drawer recess	17
Cleaning the pump	17-18
Cleaning the water inlet filter	18
The dangers of freezing	18
Emergency emptying out	18
<b>Something Not Working</b>	<b>19-20</b>

## For the Installer

<b>Description of the Appliance</b>	<b>21</b>
Detergent dispenser drawer	21
Child safety feature	21
<b>Installation</b>	<b>22</b>
<b>Technical Specifications</b>	<b>23</b>
Unpacking	23
Positioning	23
Installation on a suspended floor	23
Plumbing in	23
Water inlet	24
Water drainage	24-25
Levelling	25
In the interest of the environment	25
Electrical connection	26
Permanent connection	27
<b>Repairs - After Sales Service</b>	<b>27</b>

## Guide to use the Instruction Manual

The following symbols will be found in the text to guide you throughout the instructions:



**Safety instructions**



**Hints and tips**



**Environmental information**



This appliance complies with the following E.E.C. Directives:

- 73/23 EEC of 19.2.73 (Low Voltage Directive) and subsequent modifications;

- 89/336 EEC of 3.5.89 (Electromagnetic Compatibility Directive) and subsequent modifications.

# The control panel

## Important!

The control panel is illustrated below. It shows the programme selector dial as well as the different buttons and the pilot lights. These are represented by relevant numbers which are explained in the table below.

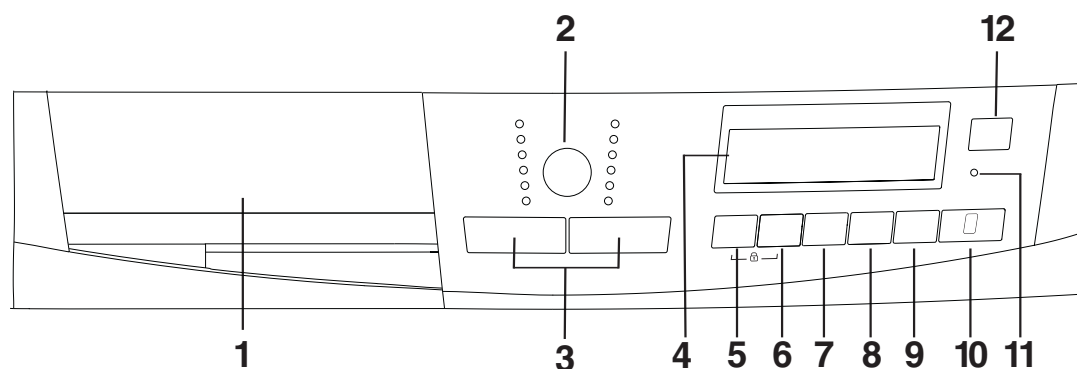

- 1 Detergent dispenser drawer**
- 2 On/Off and Reset button**
- 3 Programme selector buttons**
- 4 Multi-display**
- 5 Temperature button**
- 6 Spin speed button**

- 7 Options button**
- 8 Extra Rinse button**
- 9 Quick button**
- 10 Start/Pause button**
- 11 Door Lock pilot light**
- 12 Delay Start button**

## Display and buttons

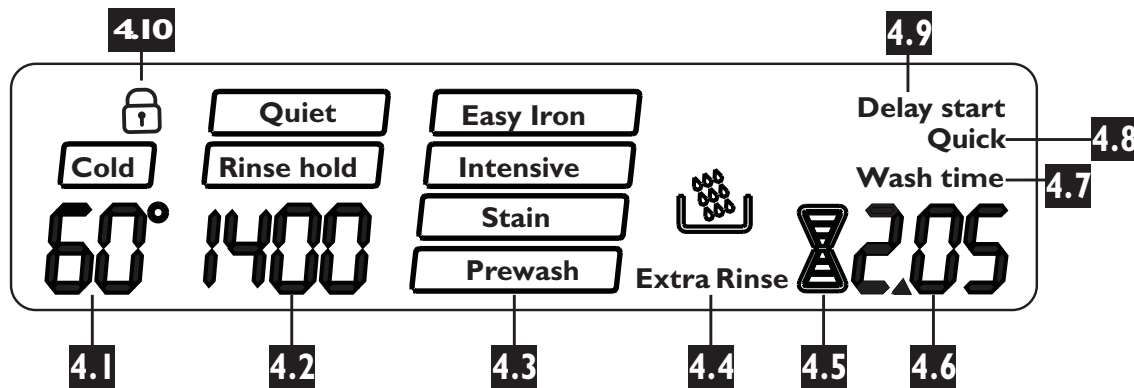

### Multi-Display (4)

**4.1 Temperature indicator:** the provided washing temperatures are 95° or 90° - 60° - 50° - 40° - 30°. Cold corresponds to cold washing.

**4.2 Spin speed indicator - «Rinse hold» and «QUIET» options**  
**Note!** The spin exclusion is indicated by a «U».

**4.3 Available options:** Easy iron, Intensive, Stain and Prewash. The rectangle around an option appears when the option is selected, disappears when the appliance starts operating (after pressing button 10).

**4.4 Extra rinse option.**

**4.5 Cycle duration calculating symbol:** when selecting the «proportional» programmes, the display shows the washing duration of the maximum recommended load. After the button 10 has been pressed, on the display the «Wash time» (4.7) starts blinking and the animated symbol 4.5 appears to indicate that the appliance is calculating the laundry amount and the real duration. During this time, the washing duration shown decreases. When the calculating phase has finished, the «Wash time» stops blinking, the animated symbol 4.5 disappears and the washing time is adjusted to the real load.

**4.6 The following pieces of information are shown on the display.**

- **Duration of the programme** in hours and minutes, after you have selected a programme (ex. 2.05). While the programme is running (after you have pressed the button 10), the displayed time value decreases by one unit every minute.

- **The washing machine has completed the programme:** this is indicated by a **blinking zero** (U). The «Door Lock» pilot light (11), the pilot light of button 10 go out and the door can be opened.
- **The washing machine has stopped with water in the tub,** at the end of a programme with the «Rinse hold» or «Quiet» option: this is indicated by a **blinking zero**. The light of button 10 goes out but the pilot light 11 is still on. The door cannot be opened. **Note!** If your laundry is not removed within 10 minutes after the programme has finished, all pilot lights and the display switch off and the energy saving system will be enabled. Only the green light of button 10 blinks to indicate that the appliance has to be switched off. By pressing any buttons the appliance will come out from the energy saving status and you could set another washing programme or switch off the appliance. The STAND BY status is incompatible with the «Delay start» option.
- **Delay start,** a time value indicated in hours (ex. 15h) and selected by pressing button 12. The delay time (20 hours max) is displayed for a few seconds, then the duration of the selected programme reappears. After you have pressed the button 10, the countdown is updated every hour, and, for the last hour, every minute.
- **An incorrect option selection has been made:** this is indicated by the message «Err» for about a few seconds when a function incompatible with the current programme is selected.
- **An alarm code** indicates a fault with the machine (ex. E20, see the relevant chapter).

#### 4.7 Wash time message:

- It is on when the washing cycle starts and when the duration is shown on the display.
- It goes off at the end of the cycle, and during the delayed start selection.
- It blinks during the time calculation if you have selected a «**proportional**» programme.

#### 4.8 Quick message: it appears when the QUICK option is selected.

#### 4.9 Delay start message: it appears during the selection of the delayed start.

#### 4.10 Child safety Lock symbol: it appears when this function is enabled. This function works in two different ways:

- If enabled before the «**Start/Pause**» button is pressed, it prevents the machine from being started.

- If enabled after pressing the «**Start/Pause**» button, it prevents any changes being made to the programmes or options selected.

To enable or disable this function, press the «Temperature» and «Spin» buttons simultaneously for approx 6 seconds until the icon  appears on or disappears from the display.

## Acoustic Signal

At the end of a washing cycle and in case of operating problems, an acoustic signal will sound.

You can deactivate the acoustic signal (except if there is a fault) by pressing the "Options" and the "Extra rinse" buttons simultaneously for about 5 seconds.

By pressing these buttons again the acoustic signal is reactivated.

## Buttons (2, 3, 5, 6, 7, 8, 9, 10, 11 and 12)

### «On/Off» / «Reset» programme button (2)

Press this button to switch the washing machine on. The green light of button **10** starts blinking. The pilot light relevant to the programme automatically proposed by the appliance lights up. The display goes on and shows some information about the selected programme.

Press this button again to switch the machine off.

#### **Warning!**

**Always switch off the appliance by pressing button 2.** (Cancel programme). This ensures that the new programme begins correctly and all previously set functions are cancelled.

### «Programme selector» buttons (3)

Press these buttons repeatedly to select the programme on the basis of the type of laundry to be washed or a special programme. The pilot light relevant to the selected programme lights up. The washing machine proposes a temperature and automatically selects the maximum spin value provided for the

programme you have chosen. You can change these values by operating buttons **5** and **6**.

The duration of the selected washing programme is shown on the display (**4.6**).

The display also shows the options compatible with the programme (except Extra rinse, Quick and Delay start).

#### **Warning!**

If you press one of these buttons while a wash programme is running, the **red** pilot light of button **10** blinks three times and **Err** is displayed to show a wrong selection.

### «Temperature» button (5)

Press this button repeatedly to increase or decrease the temperature, if you want your laundry to be washed at a temperature different from the one proposed by the washing machine (**4.1**).

#### **Note!**

To see the maximum and the minimum temperature provided for each of the washing programmes, see chapter «Washing Programmes».





## «Spin» button (6)

Press this button repeatedly to change the spin speed, if you want your laundry to be spun at a speed different from the one proposed by the washing machine.

### Note!

When you select a programme or a function, the display shows the maximum spin speed allowed (4.2).

By pressing button **6** you can also choose **No Spin** option «», **Rinse Hold** option and **Quiet** option:

**No spin** «»: this option eliminates all the spin phases and increases the number of rinses. This option is indicated by a zero.

**Rinse hold** : when you choose this option, the machine will not drain the water of the last rinse, so as not to crease the laundry. The selected option is displayed.

**Quiet** : when you choose this option, the machine will not drain the water of the last rinse, so as not to crease the laundry. The selected option will be displayed. As all spinning phases are cancelled, this washing cycle is very quiet and it can be selected at night or in times with a more economical power rate. Selecting this function, the appliance performs some additional rinses in all programmes. This function **cannot** be used in combination with «EASY IRON» function.

To empty out the water, see the paragraph «End of programme».

## «Options» button (7)

Press the button repeatedly until a rectangle appears around the desired function. Only one of the four functions can be selected.

Only the functions compatible with the selected programme are displayed.

### «Prewash» function

If this function is selected before the appliance is started, the wash programme set runs with pre-wash (max. 30°C). This increases the programme duration by about 30 minutes.

This is only required with very soiled laundry. The pre-wash ends with a short spin in the Cottons and Synthetics programme settings, whereas in Delicates the water is just drained.

## «Stain» Function

Select this option to treat heavily soiled or stained laundry with stain remover (extended main wash with time optimised stain action phase). This option is not available with a temperature lower than 40°C.

**Attention!** If you wish to perform a programme with the stain option, pour stain remover into compartment .

## «Intensive» Function

Select this option for heavily soiled laundry. If you depress this button the washing intensity will be increased and the washing time will be prolonged by approx. 10 minutes.

This function **cannot** be used in combination with QUICK function.

## «Easy Iron» Function

Selecting this button the laundry is gently washed and spun to avoid any creasing. In this way ironing is easier. Furthermore the machine will perform some additional rinses in the compatible programmes. The spin speed is automatically reduced.

This function **cannot** be used in combination with «Quiet» function.

### Note!

For the compatibility between a function and a washing programme, see «Washing Programmes».

## «Extra rinse» button (8)

By pressing this button the relevant symbol and name appears on the display.

The machine performs some additional rinses.

This is recommended in areas with especially soft water and for people with sensitive skin.

### Note!

For the compatibility between a function and a washing programme, see «Washing Programmes».

## «Quick» button (9)

By pressing this button, the option description appears in the display. This option can be used for lightly soiled in order to obtain a good washing programme in a short time. The washing time will be reduced according to the type of fabric and the selected temperature. This function **cannot** be used in combination with «Intensive» function.



**Note!**

For the compatibility between a function and a washing programme, see «Washing Programmes».

**«Start/pause» button (I0)**

**Start** = To start the selected programme, press the button I0; the pilot light is now lit permanently.

If you have selected a delay time, the countdown will begin and will be shown on the display.

**Pause** = By pressing this button, a running programme can be interrupted at any time and can be started again by pressing the button again.

During the pause, the green light in the button blinks.

**Note!** If an incorrect option is selected, the **red** pilot light for this button flashes 3 times and the message **Err** is displayed for a few seconds.

**Important!** You must set the washing machine to Pause before you make any change to the programme in progress.

**Door Lock pilot light (II)**

This pilot light illuminates to indicate that the appliance starts operating and the door is locked. It stays on during the whole programme. When the light goes out, the door can be opened.

The pilot light II indicates if the door can be opened:

- Light on: the door cannot be opened. The appliance is running.
- Light off: the door can be opened. The washing programme is finished.

The door is locked during the entire programme. It can be opened if certain conditions are fulfilled (see chapter «Opening the door after the programme has started»).

**«Delay start» button (I2)**

The wash programme can be delayed from 30 min - 60 min - 90 min, 2 hours and then by 1 hour up to a maximum of 20 hours by means of this button. This makes it possible to wash at times with a more economical power rate.

Press the button repeatedly until the desired time is displayed in the multi-display.

The selected delay time value (up to 20 hours) will appear on the display for a few seconds, then the duration of the programme will appear again.

The function cannot be selected in the «Drain» programme.

**Selecting the delayed start**

- Select the programme and the required functions
- Select the delayed start
- Press the button **I0**

The time set is now counted down in hours. The programme starts after the selected delay has expired.

**Opening the door throughout the delay time**

During the period until the delayed start, the door can be opened and laundry added:

- Press the button **I0**
- Put laundry in
- Close the door
- Press the button **I0** again.

The programme will start after the countdown has expired.

**Cancelling the Delay Start**

- Press the button **I0**
- Press the button **II** repeatedly until «0» (0 hours) appears on the display.
- Press the button **I0** again, the programme starts immediately.

**Changing the Delay Start Timer**

It is only possible to change the Delay Start by switching off the appliance: press button **2** before it takes effect and reselecting the programme.

# Using the washing machine

Before the first wash, we recommend that you run a cotton cycle at the highest temperature, without any laundry in the machine, to remove any manufacturing residue from the drum and tub. Pour 1/2 a measure of detergent into the dispenser drawer and start the machine.

## Load the laundry

Open the door. Place the laundry in the drum, one item at a time, shaking them out as much as possible. Close the door.

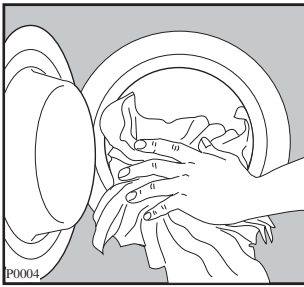

## Measure out the detergent

Pull out the dispenser drawer until it stops. Measure out the amount of detergent required and pour it into the main wash compartment .

If you wish to carry out the prewash or a stain phase, pour detergent or stain remover into the appropriate compartment marked .

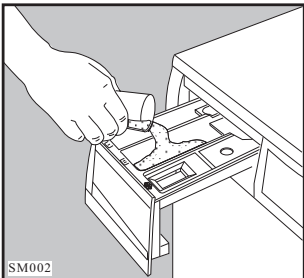

### Important!

Do not use normal detergent for the "Stain" option, always use a Stain remover.

## Measure out the fabric softener

If required, pour fabric softener into the compartment marked , **without exceeding the «MAX» mark.**

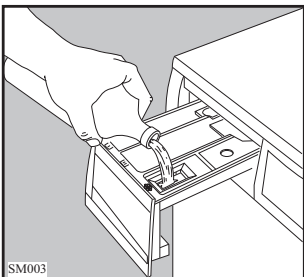

Close the drawer gently.

## Switch the machine on and select the desired programme

Switch the machine on by pressing button **2**. Select the desired programme by pressing one of the buttons **3**.

The running time is displayed in the multi-display. The light of the button **10** starts flashing.

## Select the desired temperature and spin speed

Press the button **5** repeatedly in order to select the desired temperature and the button **6** in order to select the desired spin speed, or «No Spin», «Rinse hold» or «Quiet» option.

## Select the desired options

If your laundry is very dirty, it may be advisable to select the **Prewash** or **Intensive** option.

If your laundry has heavy stains and it is necessary to prolong the washing time, select the **Stain** option. The special detergent for stains (Stain remover) is loaded from the compartment marked .

When **Easy Iron** option is selected, the laundry will be gently washed and spun to avoid creasing.

The relevant name will be displayed in the relevant rectangle (4.3).

## Select the Extra rinse option

If you wish your appliance to perform an additional rinse press the button **8**.

The relevant symbol icon and name will appear in the display.

## Select the Delay start option

**Before you start the programme**, if you wish the start to be delayed, press the button **12** repeatedly, or keep it pressed, to select the desired delay. The selected delay time value (up to 20 hours) will appear on the display for a few seconds, then the duration of the programme will appear again.

## Start the programme

Press the button **10**. The relevant green light will stop flashing.

If you have chosen a delayed start, the washing machine will begin the countdown.

The display will show the duration of the programme or the selected delay.

## Programme correction

As long as the wash programme has not been started yet, the programme selection can still be changed.

If the programme has been started, it is only possible to correct the functions, if the programme is first interrupted by pressing button **10**. In this case only some of the following functions can be selected depending on the programme which is running: Spin reduction, No Spin, Rinse hold, Easy Iron, Extra Rinse and Quiet.

If the wash programme is to be corrected by means of buttons **3**, the appliance must first be switched off by pressing the button **2**.

Switch on the appliance, set the new programme and press button **10** again. The water remains in the tub.

## Cancel a programme or switch the appliance off

If a washing programme that has already started is to be cancelled, press button **2** to RESET the programme. All lights and the display go out and the appliance is switched off. The previously selected programme is now cancelled. Another programme can now be selected

### Note!

If any problems occur as the programme runs, always first switch the appliance off by pressing button **2** before a new programme is selected. Consider the temperature to which the washing water may already have been heated.

## How to interrupt a programme

By pressing the button **10**, a running programme can be stopped. The light in the button flashes.

The programme is continued by pressing the button again.

## Opening the door after the programme has started

The door can be opened while a programme is running, if certain conditions are fulfilled:

- The washing machine is not in the heating phase beyond 55°C;
- The level of the water is not high;

If these requirements are met, when you pause the washing machine, the light **11** goes off and the door can be opened. If the light **11** remains lit, the door cannot be opened. In any case, do not force it!

Should it not be possible to open the door, and should it be absolutely necessary to do so, switch the appliance off by pressing button **2**. After a few minutes, you can open the door.

### Pay attention to the level and temperature of the water in the washing machine!

When you close the door to restart the programme select the previous programme by pressing the buttons **3**, repeat the options previously selected and press the button **10**.

## End of programme

The pilot light of the button **10** goes out. «**11**» blinks and the message **Wash time** disappears from the multi-display.

The pilot light **11** goes out. The door can now be opened and the laundry can be removed.

### Switch the appliance off by pressing button 2, before remove the laundry.

If the **Rinse Hold** or **Quiet** option has been selected the pilot light **11** is on, the pilot light of the button **10** goes out and the display shows a blinking «**11**».

The door cannot be opened because the water must be drained.

### To empty out the water there are 2 possibilities:

- Select the draining programme and press the button **10** : the water is emptied out without spinning.
- Select the spinning programme. Select the spin speed by pressing the relevant button and then press the button **10**. The water is emptied out and the laundry is spun at the selected spin speed.

### Switch the appliance off by pressing button 2.

Remove the laundry from the drum and carefully check that the drum is empty. If you do not intend to carry out another wash, close the water tap and disconnect the plug from the socket. Leave the door open to prevent the formation of mildew and unpleasant smells.

# Hints & tips on washing

Do **NOT** overload the machine. Weigh the laundry the first few times you use the appliance.

The average weights of the most common items are listed below as a guide:

## 1000g = 1 kg

Sheet	700-1000 g
Pillow case	100-200 g
Tablecloth	400-500 g
Serviette	50-100 g
Tea towel	70-120 g
Linen hand towel	100-150 g
Towelling hand towel	150-250 g
Towelling bath towel	700-1000 g
Bath robe	1000-1500 g
Man's shirt	200-300 g
Apron	150-200 g

- Load the laundry loosely alternating large items with small ones.
- Sort the laundry according to the type of fabric, colour-fastness and how dirty it is.
- Avoid washing unhemmed or torn items as they may unravel.
- Before washing, empty all pockets of small objects which may have been left inside (coins, keys, screws etc). as these could damage the drain pump.
- When washing curtains, remove the hooks.
- Close poppers and zips and fasten loose buttons.
- It is essential to wash new coloured items separately when washing for the first time.
- When washing fabrics requiring different wash temperatures together, always select the lowest temperature.
- White items should not be washed with coloured items.
- Very small items (handkerchiefs, ribbons, socks etc) should be washed in a washing bag or a pillow case.
- Use a good quality detergent suitable for automatic washing machines.
- Use the correct quantities of detergent.
- For wool, use gentle detergent only in small quantities.
- Bleach is very corrosive; it should be used with care and kept out of reach of children.
- Some stains such as fruit, wine, grass, rust etc. are difficult to remove and should be treated before washing with specific products, which can be found in most household shops. In some cases it may help to soak the stain before washing with a special pre-soak product or biological detergent.
- If you have used the machine to wash, rinse or spin only non-colour fast garments, there may be dye left in the sump. To ensure any subsequent wash is not contaminated with the dye, select and carry out a rinse and spin programme, without any garments, to ensure that any dye is removed from the sump.
- Once you have finished using the machine, you are advised to unplug it and turn off the water tap.
- **Warning!**  
If the programme begins later, in case of Delay start selected, a dosing container must be used for the liquid detergent, e.g. a ball, as supplied by the detergent manufacturers.
- Underwired bras must NOT be machine washed.

# Wash care symbols

Wash care labels inside garments recommend how to launder your clothes with the best results. The care labelling code is in line with care labelling used in the rest of Europe. The symbols used make it easy to select the correct programme on your washing machine.

WASHING SYMBOL	WASH ACTION	FABRIC
	Normal (Maximum)	White Cotton or Linen without Special Finishes
	Normal (Maximum)	Cotton, Linen or Viscose without Special Finishes Colourfast at 60°C.
	Reduced (Medium)	Nylon, Polyester/Cotton, Viscose with Special Finishes, Cotton/Acrylic Mix.
	Normal (Maximum)	Cotton, Linen or Viscose Colourfast at 40°C but not 60°C.
	Reduced (Medium)	Acrylics, Acetate, Triacetate, Wool mixes, Polyester/wool blends.
	Much Reduced (Minimum)	Wool, wool mixtures, Silks
	Hand wash only	Do not machine wash
<b>BLEACHING</b>		
	Chlorine bleach may be used	
<b>IRONING</b>		
	Hot iron	Cotton, Linen, Viscose
	Warm iron	Polyester mixtures, Wool
	Cool iron	Acrylic, Nylon, Polyester
<b>DRY CLEANING</b>		
	May be dry cleaned. Other letters and/or a bar beneath the circle will indicate the required process to the dry cleaner.	
<b>TUMBLE DRYING</b>		
	with high heat setting	
	with low heat setting	
	May be tumble dried	
	A cross through any symbol means « <b>DO NOT</b> »	

## Important notes

For best results, always use the dispenser drawer for dispensing detergents and liquid additives. Once the dispenser has been filled, close it by pushing it in gently. This is particularly important if you are using

fabric conditioner to avoid the conditioner entering the machine prematurely. When using liquid detergent and a prewash programme, place the detergent into the correct compartment in the dispenser drawer, after the prewash has finished.

# Washing programmes

Type of fabric /Programme description	Programme/temperature	Available options	Load	Consumptions*	
				Energy kWh	Water litres
<b>White, fast coloured and non-fast cotton items</b> Main wash - rinses - spin at 1400 rpm	<b>Cottons<sup>(1)</sup></b> <b>95° - COLD</b>	<b>Spin reduction/No Spin/Rinse hold/Quiet, Easy Iron, Prewash, Intensive, Stain**, Extra rinse, Quick</b>	8 Kg	2.55	65
<b>White, fast coloured and non-fast cotton items</b> Main wash - rinses - spin at 1400 rpm - For slightly or normally soiled cotton items. The temperature will decrease and the washing time will be extended. This allows you to obtain a good washing efficiency whilst saving energy.	<b>Cottons Economy</b> <b>60° - 40°</b>	<b>Spin reduction/ No Spin/ Rinse hold/Quiet, Easy Iron, Prewash, Stain, Extra rinse, Quick</b>	8 Kg	1.36	57
<b>Synthetics</b> Main wash - rinses - spin at 900 rpm	<b>Synthetics<sup>(1)</sup></b> <b>60° - Cold</b>	<b>Spin reduction/No Spin/Rinse hold/Quiet, Easy Iron, Prewash, Intensive, Stain**, Extra rinse, Quick</b>	4 Kg	1.15	55
<b>Delicates</b> such acrylic, viscose, polyester items, curtains Main wash - rinses - spin at 700 rpm	<b>Delicates</b> <b>40° - Cold</b>	<b>Spin reduction/No Spin/ Rinse hold/Quiet, Prewash, Stain**, Extra rinse, Quick</b>	4 Kg	0.6	67
<b>Hand wash (Wool)</b> Garments bearing the «Hand wash» label Main wash - rinses - spin at 1000 rpm	<b>Hand wash</b> <b>40° - Cold</b>	<b>Spin reduction/ No Spin/ Rinse hold/ Quiet</b>	2 kg	0.5	63

<sup>(1)</sup> **Cycle time duration, energy and water consumptions are proportional to the amount of load.**

The «**Economy Cottons**» at 60°C with a load of 8 kg is the reference programme for the data entered in the energy label, in compliance with EEC 92/75 standards.

\* This data is given purely as an indication: the consumption values may vary in relation to the quantity and type of laundry, the temperature of the water supply and the ambient temperature. The data refers to the highest temperature provided for each programme.

\*\* Only at a temperature of 40°C or higher.

# Washing programmes

Programme description	Programme	Available options	Load	Consumptions*	
				Energy kWh	Water litres
<p><b>Lingerie, underwear</b> Main wash - rinses - spin at 900 rpm This programme is suitable for very delicate items, as lingerie, bras and etc. The maximum spin speed is automatically reduced.</p>	<b>Lingerie 40° - Cold</b>	<b>Spin reduction/ No Spin/ Rinse hold/ Quiet</b>	1 kg	0.45	60
<p>3 rinses - Spin at 1400 rpm With this programme it is possible to rinse and spin cotton garments which have been washed by hand. The machine performs 3 rinses, followed by a final long spin. <b>Important!</b> The spin speed will automatically assume the setting for cotton items. If required, reduce the speed to the desired level by pressing the button <b>6</b>.</p>	<b>Rinse Cold</b>	<b>Spin reduction/ No Spin/ Rinse hold/ Quiet, Easy Iron, Extra rinse</b>	8 Kg	0.15	47
<p><b>Water draining</b> For emptying out the last rinse of the programmes with <b>Rinse Hold</b> or <b>Quiet</b> option</p>	<b>Drain</b>	-	8 Kg	-	-
<p>Drain - long spin at 1400 rpm Separate long spin at the max speed for hand washed garments. The spin speed will automatically assume the setting for cotton items. So, if you are spinning extra delicate items we recommend that you reduce the speed by pressing the button <b>6</b> to adapt it to the fabrics to be spun and/or to interrupt the duration of the spinning phase (put the machine in PAUSE or switch the machine off).</p>	<b>Spin</b>	<b>Spin reduction</b>	8 Kg	-	-

**For the duration of the programmes, please refer to the display on the control panel.**

\* This data is given purely as an indication: the consumption values may vary in relation to the quantity and type of laundry, the temperature of the water supply and the ambient temperature. The data refers to the highest temperature provided for each programme.



Programme description	Programme	Available options	Load	Consumptions*	
				Energy kWh	Water litres
Main wash - rinses - spin at 700 rpm Duvet, blanket of cotton or synthetic items	<b>Duvet 40° - 30°</b>	<b>Spin reduction</b>	2 Kg	0.6	78
Main wash - rinses - spin at 900 rpm This is a complete programme that can be used for laundry which is lightly soiled or which needs freshening up.	<b>14 Minute wash 30°</b>	<b>Spin reduction /No Spin/ Rinse hold</b>	1 Kg	0.2	48
Main wash - rinses - Spin at 1200 rpm Short cycle for lightly soiled cotton fabrics	<b>45 Minute wash 60°</b>	<b>Spin reduction /No Spin/ Rinse hold Extra rinse</b>	4 kg	1.2	50

**For the duration of the programmes, please refer to the display on the control panel.**

# Maintenance and cleaning

**You must DISCONNECT the appliance from the electricity supply, before you can carry out any cleaning or maintenance work.**

## Descaling

The water we use normally contains lime. It is a good idea to periodically use a water softening powder in the machine. Do this separately from any laundry washing, and according to the softening powder manufacturer's instructions. This will help to prevent the formation of lime deposits.

## After each wash

Leave the door open for a while. This helps to prevent mould and stagnant smells forming inside the appliance. Keeping the door open after a wash will also help to preserve the door seal.

## Maintenance wash

With the use of low temperature washes it is possible to get a build up of residues inside the drum. We recommend that a maintenance wash be performed on a regular basis.

### To run a maintenance wash:

- The drum should be empty of laundry.
- Select the hottest cotton wash programme.
- Use a normal measure of detergent, must be a powder (such as Ariel Futur).

## External cleaning

Clean the exterior cabinet of the appliance with soap and water only, and then dry thoroughly.

## Cleaning the dispenser drawer

The washing powder and additive dispenser drawer should be cleaned regularly. Remove the drawer by pressing the catch downwards and by pulling it out. Flush it out under a tap, to remove any traces of accumulated powder. To aid cleaning, the top part of the additive compartment should be removed.

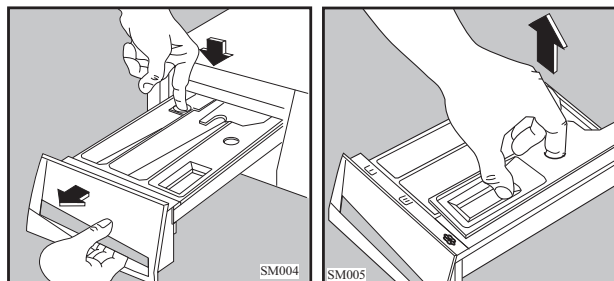

## Cleaning the drawer recess

Having removed the drawer, use a small brush to clean the recess, ensuring that all washing powder residue is removed from the upper and lower part of the recess. Replace the drawer and run the rinse programme without any clothes in the drum.

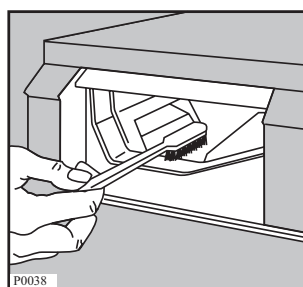

## Cleaning the pump

The pump should be inspected if

- The machine does not empty and/or spin
- The machine makes an unusual noise during draining due to objects such as safety pins, coins etc. blocking the pump.

Proceed as follows:

- Disconnect the appliance.
- If necessary wait until the water has cooled down.
- Open the pump door.

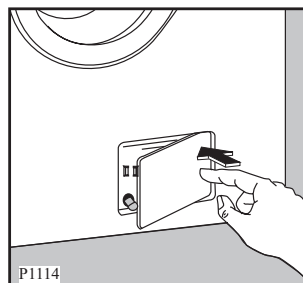

- Place a container close to the pump to collect any spillage.
- Pull out the emergency emptying hose, place it in the container and remove its cap.

- When no more water comes out, unscrew the pump cover and remove it. Always keep a rag nearby to dry up spillage of water when removing the cover.

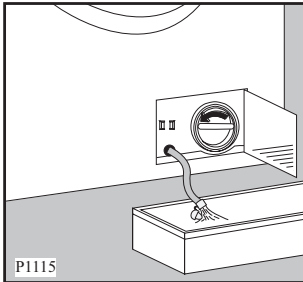

- Remove any objects from the pump impeller by rotating it.

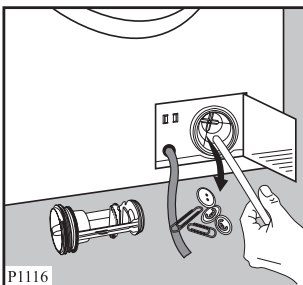

- Put the cap back on the emergency emptying hose and place the latter back in its seat.

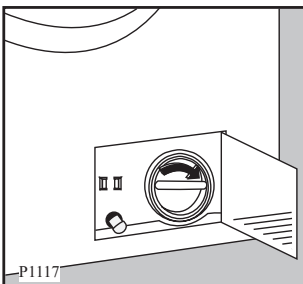

- Screw the pump cover fully in.
- Close the pump door.

### **Warning**

When the appliance is in use and depending on the programme selected there can be hot water in the pump. Never remove the pump cover during a wash cycle, always wait until the appliance has finished the cycle, and is empty. When replacing the cover, ensure it is securely retightened so as to stop leaks and young children being able to remove it.

## Cleaning the water inlet filter

If your water is very hard or contains traces of lime deposit, the water inlet filter may become clogged. It is therefore a good idea to clean it from time to time. Turn off the water tap. Unscrew the water inlet hose.

Clean the filter using a hard bristle brush.

Refit the inlet hose.

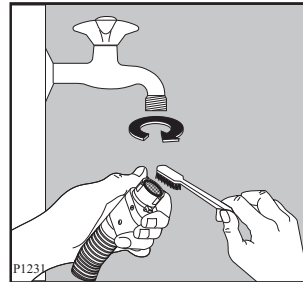

## The dangers of freezing

If the machine is exposed to temperatures below 0°C, certain precautions should be taken.

- Turn off the water tap.
- Unscrew the inlet hose.
- Place the end of the emergency emptying hose and that of the inlet hose in a bowl placed on the floor and let water drain out.
- Screw the water inlet hose back on and reposition the emergency emptying hose after having put the cap on again.
- When you intend to start the machine up again, make sure that the room temperature is above 0°C.

## Emergency emptying out

If the water is not discharged, proceed as follows to empty out the machine:

- Pull out the plug from the power socket;
- Close the water tap;
- If necessary, wait until the water has cooled down;
- Open the pump door;
- Place a bowl on the floor and place the end of the emergency emptying hose into the bowl. Remove its cap. The water should drain by gravity into the bowl. When the bowl is full, put the cap back on the hose. Empty the bowl. Repeat the procedure until water stops flowing out;
- Clean the pump if necessary as previously described;
- Replace the emergency emptying hose in its seat after having plugged it;
- Refit the the pump and close the door.

# Something not working

Please carry out the following checks before contacting your local Service Force agent.

**IMPORTANT: If you call out an engineer to a fault listed below, or to repair a fault caused by incorrect use or installation, a charge will be made even if the appliance is under guarantee.**

During machine operation it is possible that the **red** pilot light of the button **IO** flashes, one of the following alarm codes appears on the display and some acoustic signals sound to indicate that the machine is not working:

- *E10* : problem with the water supply
- *E20* : problem with water draining
- *E40* : door open
- *EFD* : Anti-flooding system has activated

Once the problem has been eliminated, press the button **IO** to restart the programme. If after all checks, the problem persists, contact your local Service Force Centre.

Symptom	Solution
<b>The machine does not start</b>	<ul style="list-style-type: none"> <li>● The door has not been closed. (<i>E40</i> )</li> <li>● The plug is not properly inserted in the power socket.</li> <li>● There is no supply at the socket.</li> <li>● The main fuse or the fuse in the plug has blown.</li> <li>● The button <b>IO</b> has not been pressed.</li> <li>● The <b>Delay start</b> option has been selected.</li> <li>● The <b>Child lock</b> option has been enabled.</li> </ul>
<b>The machine does not fill</b>	<ul style="list-style-type: none"> <li>● The water tap is closed. (<i>E10</i> )</li> <li>● The filter in the inlet hose is blocked. (<i>E10</i> )</li> <li>● The inlet hose may be squashed or kinked. (<i>E10</i> )</li> <li>● The door has not been closed. (<i>E40</i> )</li> </ul>
<b>The machine fills then empties immediately</b>	<ul style="list-style-type: none"> <li>● The end of the drain hose is too low.</li> <li>● The end of the drain hose is submerged in water.</li> <li>● There is no vent in the end of the drain hose.</li> </ul>
<b>The machine does not empty and/or does not spin</b>	<ul style="list-style-type: none"> <li>● The drain hose may be squashed or kinked. (<i>E20</i>)</li> <li>● The <b>Rinse Hold</b> or <b>Quiet</b> option has been selected.</li> <li>● The drain pump may be blocked. (<i>E20</i>)</li> <li>● The <b>No Spin</b> option has been selected</li> <li>● The drainage system pipes are blocked.</li> </ul>
<b>There is water on the floor</b>	<ul style="list-style-type: none"> <li>● Too much detergent or unsuitable detergent has been used (creates too much foam).</li> <li>● Check whether there are any leaks from the inlet hose fittings. It is not always easy to see this as the water runs down the hose; check to see if it is damp.</li> <li>● The inlet or drain hose may be damaged or not securely positioned.</li> <li>● The cap on the emergency emptying hose has not been replaced after cleaning the filter.</li> </ul>
<b>Unsatisfactory washing results</b>	<ul style="list-style-type: none"> <li>● Too little detergent or unsuitable detergent has been used. An insufficient amount of detergent leaves the laundry looking grey and causes lime scale to form.</li> <li>● Stubborn stains have not been treated prior to washing</li> <li>● The correct wash programme/temperature has not been selected.</li> <li>● Too much laundry has been placed in the drum.</li> </ul>

Symptom	Solution
<b>The green Start/Pause light flashes and the display seems off</b>	<ul style="list-style-type: none"> <li>• The energy save system is enabled. Press any button to switch the appliance on.</li> </ul>
<b>The machine vibrates when spinning</b>	<ul style="list-style-type: none"> <li>• The internal packing has not been removed.</li> <li>• The machine is in contact with the wall or furniture.</li> <li>• The machine is not level and stable (check diagonally).</li> <li>• The washing load is badly distributed in the drum.</li> <li>• Maybe there is very little laundry in the drum.</li> </ul>
<b>The door will not open</b>	<ul style="list-style-type: none"> <li>• The water level is too high.</li> <li>• The machine is heating the water.</li> <li>• The drum is turning.</li> </ul> <p><b>In any case the door can be opened only when the “Door lock” light has gone out.</b></p>
<b>Spinning starts late or the machine does not spin</b>	<ul style="list-style-type: none"> <li>• The electronic balance control device has cut in because the laundry is not evenly distributed in the drum. The laundry is redistributed by reverse rotation of the drum. This may happen several times before the unbalance disappears and normal spinning can resume. If, after few minutes, the laundry is still not evenly distributed in the drum, the machine will not spin. In this case, redistribute the load manually and select the spin programme.</li> </ul>
<b>The machine makes an unusual noise</b>	<ul style="list-style-type: none"> <li>• The machine is fitted with a type of motor which makes a different noise compared with other traditional motors. This new motor ensures a softer start and more even distribution of the laundry in the drum when spinning, as well as increased stability of the machine.</li> </ul>
<b>No water is visible in the drum</b>	<ul style="list-style-type: none"> <li>• Machines based on modern technology operate very economically using very little water without affecting performance.</li> </ul>
<b>The display shows the alarm code EFO:</b>	<ul style="list-style-type: none"> <li>• Disconnect the appliance and contact the Service Force Centre.</li> </ul>

# Description of the appliance

Your new washing machine is fitted with an automatic device which detects the laundry amount in some programmes for cotton and synthetic items and chooses the best cycle parameters for washing in an economical way.



Cycle time duration, energy and water consumptions are proportional to the amount of each load.

This is ideal when washing different small quantities of laundry.

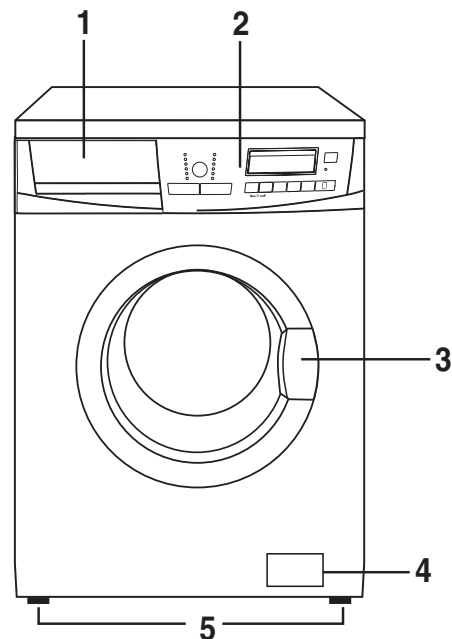
- 1 Detergent dispenser drawer
- 2 Control panel
- 3 Door handle
- 4 Drain pump
- 5 Adjustable feet



## Detergent dispenser drawer

-  Prewash
-  Main wash,
-  Fabric softener

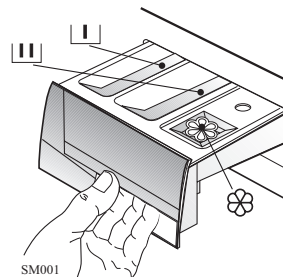

## Child safety feature



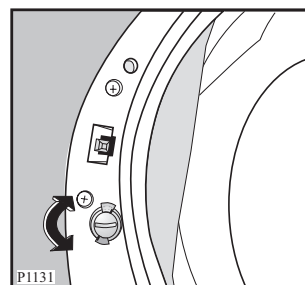

This machine incorporates a special child safety feature to prevent small children from being trapped inside the machine.

To activate this device, rotate the button (without pressing it) inside the door clockwise until the groove is horizontal. If necessary use a coin. This prevents the door from being closed.

To disable this device and restore the possibility of closing the door, rotate the button anti-clockwise until the groove is vertical.



# Installation

-  It is dangerous to alter the specifications or attempt to modify this product in any way.
-  Care must be taken to ensure that the appliance does not stand on the electrical supply cable.
-  Any electrical work required to install this appliance should be carried out by a qualified electrician or competent person.
-  Any plumbing work required to install this appliance should be carried out by a qualified plumber or competent person.

# Technical specifications

DIMENSIONS	Height Width Depth	85 cm 60 cm 60 cm
POWER SUPPLY VOLTAGE TOTAL POWER ABSORBED		230-240 V/50 Hz 2050 W (10A)
WATER PRESSURE	Minimum Maximum	0.05 MPa (0.5 bar) 0.8 MPa (8 bar)
MAXIMUM RECOMMENDED LOAD	Cotton, linen Synthetics and Delicate	8 kg 4 kg
SPIN SPEED	Maximum	1400 rpm
CONSUMPTION DATA FOR WASHING 8 KG NORMALLY SOILED COTTON ITEMS WITH PROGRAMME « <b>COTTONS ECONOMY</b> » at 60°C:	Energy Water	1.36 kWh 57 litres



## Unpacking

-  All transit bolts and packing must be removed before using the appliance.  
Keep all packaging away from children.

You are advised to keep all the transit bolts for re-use in case the machine is to be transported again.

After removing all the packaging, with assistance carefully lay machine on it's back to remove the polystyrene base from the bottom.

Remove the power supply cable and the draining hose from the hose holders on the rear of the appliance.

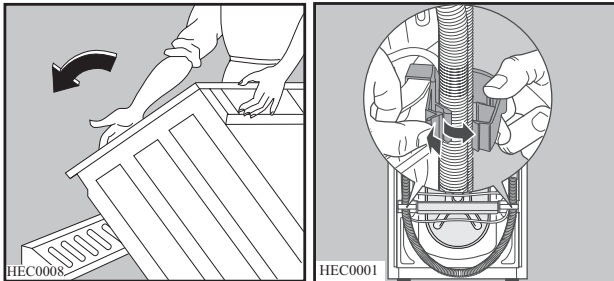

With the spanner provided unscrew and remove the central rear bolt **A**.

Unscrew and remove the two large rear bolts **B** and the six smaller bolts **C**.

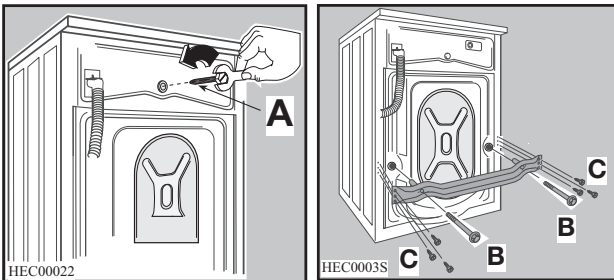

Remove the bracket **D**, refit the six smaller bolts **C** and slide out the relevant plastic spacer **E**.

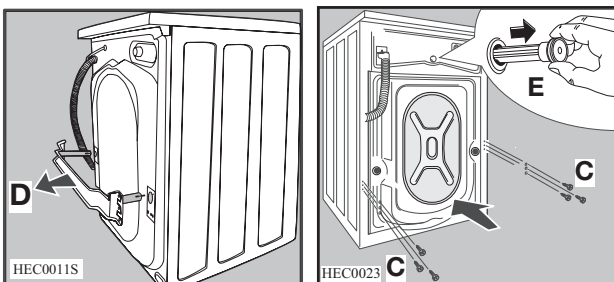

Open the porthole and remove the polystyrene block fitted on the door seal.

Fill the smaller upper hole and the two large ones with the corresponding plastic plug caps supplied in the bag containing the instruction booklet.

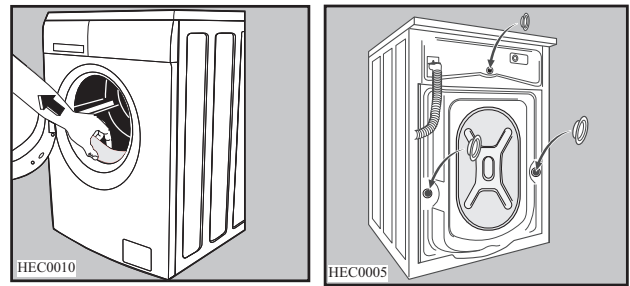

Connect the water inlet hose as described under the paragraph "Water inlet".

## Positioning

Install the machine on a flat hard floor.

Make sure that air circulation around the machine is not impeded by carpets, rugs etc. Check that the machine does not touch the wall or other kitchen units.

Never place cardboard, wood or similar materials under the machine to compensate for any unevenness in the floor.

If the floor is carpeted or covered with crumbly or soft material, insert a rigid support base under the feet to prevent noise, vibration or displacement. The base should protrude a few centimetres beyond the edges of the machine.

-  **Warning**  
The machine should NOT be placed on deep pile carpeting.

## Installation on a suspended floor

Suspended wooden floors are particularly susceptible to vibration. To help prevent vibration we recommend you place a waterproof wood panel, at least 15 mm thick under the appliance, secured to at least 2 floor boards with screws. If possible install the appliance in one of the corners of the room, where the floor is more stable.

### Note

Please ensure that when the appliance is installed it is easily accessible for the engineer in the event of a breakdown.

## Plumbing In

Your new washing machine has been designed to be permanently plumbed in to your home's water supply and drainage system. However, if this is not possible, it may be connected to a suitable existing tap with the drain hose discharging into a sink.

The appliance has an inlet hose, with female 3/4" BSP

thread connector. If this connection is not compatible with the plumbing of the existing installation, a variety of connectors are available from good hardware stores and plumbers merchants to suit most domestic plumbing. Any alteration to your existing plumbing must be carried out by a competent person, or qualified plumber.

## Water inlet

An inlet hose is supplied and can be found inside the machine drum.

**Do not use the hose from your previous washing machine to connect to the water supply.**

1. Open the porthole and extract the inlet hose .
2. Connect the hose with the angled connection to the machine.

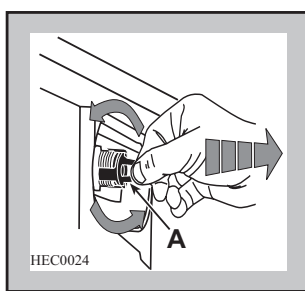

3. Remove the security gasket cup by turning and pulling it away. Pay attention not to move or remove the gasket.

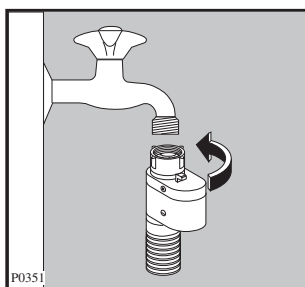

### Important!

**Do not place the inlet hose downwards. Angle the hose to the left or right depending on the position of your water tap.**

4. Set the hose correctly by loosening the ring nut. After positioning the inlet hose, be sure to tighten the ring nut again to prevent leaks.
5. Connect the hose to a tap with a 3/4" thread. Always use the hose supplied with the appliance.

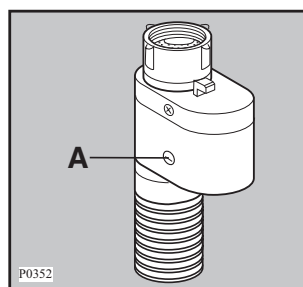

The inlet hose is provided with a water stop device, which protects against damage caused by water leaks in the hose which could develop due to natural ageing of the hose. This fault is shown by a red sector in the window "A". Should this occur, turn the water tap off and refer to your Service Centre to replace the hose. Installation should comply with local water authority and building regulations' requirements.

**The appliance must be connected to a cold water supply.**

A minimum water pressure of 0.5 bar is required for safe operation of the appliance.

If you cannot make the cold water connection direct from the rising mains, you may be able to operate the appliance from your cold water storage system.

There should be a minimum vertical distance of 5.02m (16.5 ft) between the appliance's inlet and the bottom of the water storage tank.

## Water drainage

This appliance is designed to be permanently plumbed into your home's drainage system using one of the following methods.

### 1. Into a drainage standpipe.

Firstly form a hook in the end of the drain hose using the "U" piece supplied.



Place the drain hose into your standpipe, which should have an internal diameter of approximately 38mm thus ensuring there is an air break between the drain hose and standpipe.

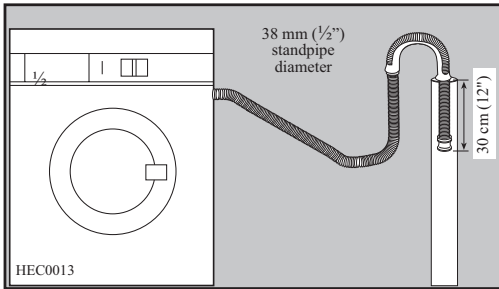

When discharging into a standpipe ensure that the top of the standpipe is no more than 90cm (35.4") and no less than 60cm (23.6") above floor level.

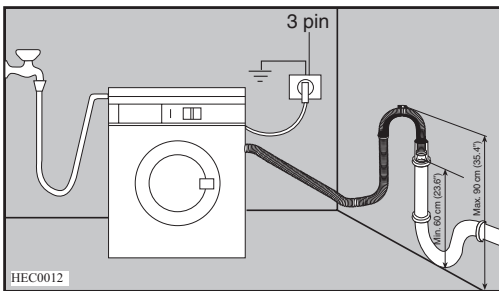

The drain hose may be extended to a maximum of 4 metres. An additional drain hose and joining piece is available from your local Service Force Centre. The joining piece must have an internal diameter of 18mm.

If your drain hose looks like this (see below) you do not require the "U" piece". Just push the hose firmly into the standpipe.

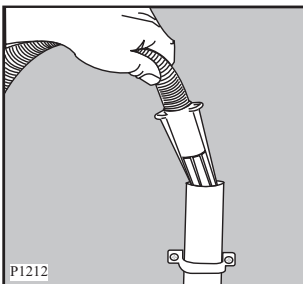

## 2. Onto a sink outlet spigot.

If the outlet spigot has not been used before, remove any blanking plug that may be in place.

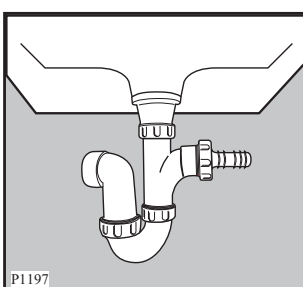

Push the drain hose onto the spigot and secure with a clip, ensure a loop is formed in the drain hose (see diagram) to prevent waste from the sink entering the washing machine.

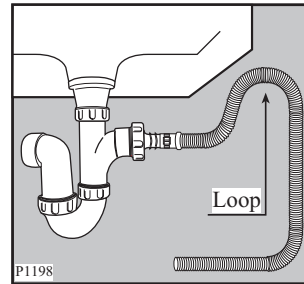

## Important

Before connecting the machine to new pipework or to pipework that has not been used for some time, run off a reasonable amount of water to flush out any debris that may have collected in the pipes.

## Levelling

Level the washing machine by raising or lowering the feet. The feet may be tight to adjust as they incorporate a self locking nut, but the machine **MUST** be level and stable. If necessary, check the setting with a spirit level.

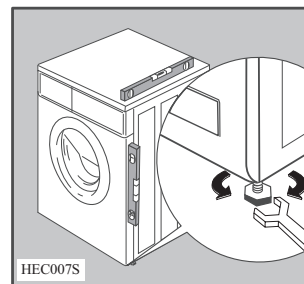

Any necessary adjustment can be made with a spanner. Accurate levelling prevents vibration, (see note on positioning), noise and displacement of the machine during operation.

Some vibration is inevitable, especially if mounted on a wooden floor.

Sprung wooden floors are particularly susceptible to vibration. For advice, consult a builder. If possible, always place the machine on a solid floor.

## In the interest of the environment

Washing machines should be connected to the FOUL drainage system, the water will then be taken to a sewage works for treatment before being discharged safely into a river.

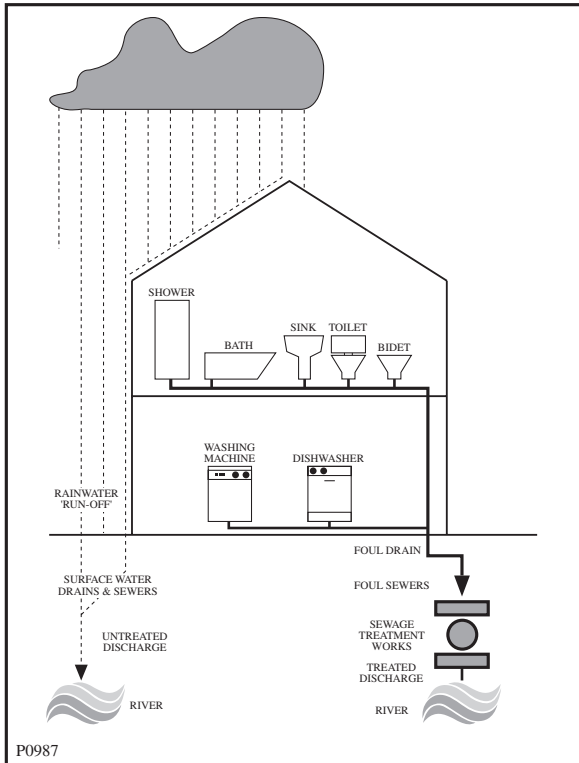

It is essential that these appliances are not connected to the surface water drainage system as this water is discharged directly into a river or stream and may cause pollution.

If you require any further advice please contact your local water authority.

## Electrical connection

Any electrical work required to install this appliance should be carried out by a qualified electrician or competent person.



**WARNING: THIS APPLIANCE MUST BE EARTHED.**

**The manufacturer declines any liability should this safety measure not be observed.**

**Should the appliance power supply cable need to be replaced, this must be carried out by a Service Force agent (see page 27).**

Before switching on, make sure the electricity supply voltage is the same as that indicated on the appliance's rating plate. The rating plate is located at the top of the rim of the open door.

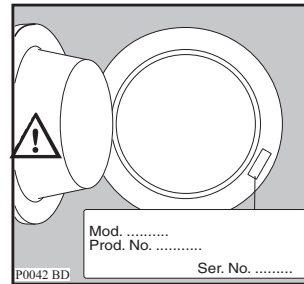

The appliance is supplied with a 13amp plug fitted. In the event of having to change the fuse in the plug supplied, a 13amp ASTA approved (BS1363/A) fuse must be used.

Should the plug need to be replaced for any reason, proceed as described below.

The wires in the mains lead are coloured in accordance with the following code:

Green and Yellow	- Earth
Blue	- Neutral
Brown	- Live

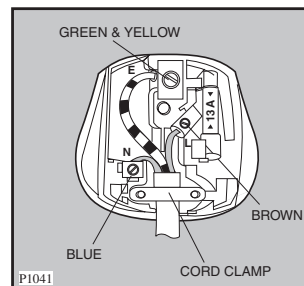

If you fit your own plug, the colours of the wires in the mains lead of your appliance may not correspond with the markings identifying the terminals in your plug.

Proceed as follows:

1. The wire coloured green and yellow must be connected to the terminal marked with the letter «E» or by the earth symbol  $\perp$  or coloured green and yellow.
2. The wire coloured blue must be connected to the terminal marked «N» or coloured black.
3. The wire coloured brown must be connected to the terminal marked «L» or coloured red.
4. Upon completion there must be no cut, or stray strands of wire present and the cord clamp must be secure over the outer sheath.

### WARNING:



**A cut off plug inserted into a 13 amp socket is a serious safety (shock) hazard. Ensure that the cut off plug is disposed of safely.**

 **The power supply cable must be easily accessible after installing the appliance.**

 **The appliance should not be connected to the electrical supply by means of an extension cable.**

## Permanent connection

In the case of permanent connection it is necessary that you install a double pole switch between the appliance and the electricity supply (mains), with a minimum gap of 3mm between the switch contacts and of a type suitable for the required load in compliance with the current electrical regulations.

The switch must not break the yellow and green earth cable at any point.

# Repairs - After sales service

In the event of your appliance requiring service, or if you wish to purchase spare parts, please contact our extended warranty administrators by telephoning:

**0870 01 07887**

They will give you details for your local Service Force Centre.

Service Force are the appointed national appliance repair agents responsible for warranty repairs to this appliance.

Before calling out an engineer, please ensure you have read the details under the heading "Something Not Working".

When you contact the Service Force Centre you will need to give the following details:

1. Your name, address and post code
2. Your telephone number
3. Clear and concise details of fault
4. The purchase date and found on your receipt.
5. The model and serial number of the appliance (found on the rating plate - see picture)

So that you always have these numbers to hand, we recommend you to make a note of them here.

Model (Mod.).....

PNC (Prod. No.).....

SN (Ser. No.).....

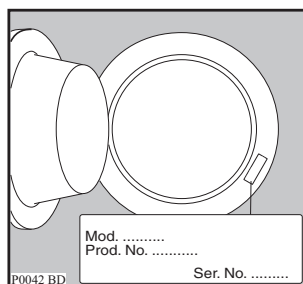

**Your washing machine is covered by a 3 year parts and labour guarantee (see separate details given at point of sale). Please retain your purchase receipt safely for the service .**

## Spare parts

An authorised service engineer should service this product, and only genuine spare parts should be used.

Under no circumstances should you attempt to repair the machine yourself.

Repairs carried out by inexperienced persons may cause injury or serious malfunctioning. Contact your local Service Force Centre.



## Free Manuals Download Website

<http://myh66.com>

<http://usermanuals.us>

<http://www.somanuals.com>

<http://www.4manuals.cc>

<http://www.manual-lib.com>

<http://www.404manual.com>

<http://www.luxmanual.com>

<http://aubethermostatmanual.com>

Golf course search by state

<http://golfingnear.com>

Email search by domain

<http://emailbydomain.com>

Auto manuals search

<http://auto.somanuals.com>

TV manuals search

<http://tv.somanuals.com>