

JLWVM I604

I600 spin washing machine

Instruction manual

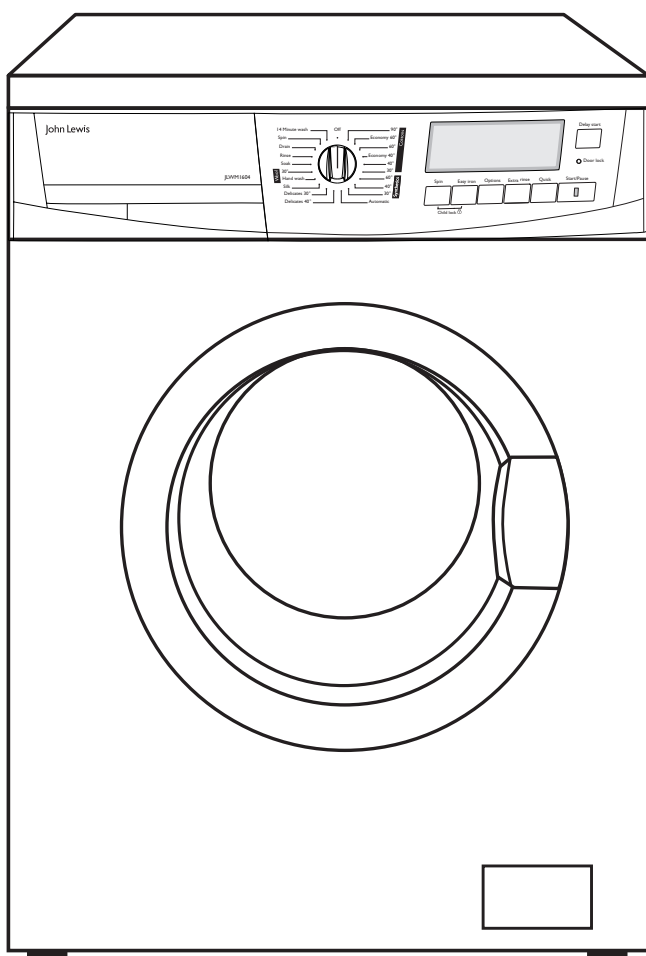

John Lewis



Important safety information

It is most important that this instruction book should be retained with the appliance for future reference. Should the appliance be sold or transferred to another owner, or should you move house and leave the appliance, always ensure that the book is supplied with the appliance in order that the new owner can get to know the functioning of the appliance and the relevant warnings.

These warnings have been provided in the interest of safety. You **MUST** read them carefully before use or installation by a qualified person.

If you are unsure of the meanings of these warnings contact the John Lewis branch from which you purchased the appliance.

Installation

- This appliance is heavy. Care should be taken when moving it.
- It is dangerous to alter the specifications or attempt to modify this product in any way.
- All packing and transit bolts must be removed before use. Serious damage can occur to the product and to property if this is not adhered to. See relevant section in instructions.
- Care must be taken to ensure that the appliance does not stand on the electrical supply cable.
- If the machine is situated on a carpeted floor, please adjust the feet in order to allow air to circulate freely.
- Always be sure, that there is no water leakage from hoses and their connections after the installation.

Child Safety

- This appliance is designed to be operated by adults. Children should not be allowed to tamper with the controls or play with the product.
- This appliance is not intended for use by person (including children) with reduced physical sensory or mental capabilities or lack of experience and knowledge unless they have been given supervision or instruction concerning use of the appliance by a person responsible for their safety.
- Pets and children have been known to climb into washing machines. Please check your drum before use.
- The glass door becomes very hot during the washing cycle. Keep children away from the vicinity of the appliance whilst it is in operation.
- Keep all packaging well away from children.
- Keep all detergents in a safe place out of children's reach.

- When the appliance is to be scrapped, cut off the power supply cable and destroy the plug with the remaining cable. Disable the door catch in order to prevent children from becoming trapped inside while playing .

Use

- Always unplug the appliance and turn off the water supply after use.
- Do not overload the appliance. See relevant section in the instruction book.
- Only wash fabrics which are designed to be machine washed. If in doubt, consult the care label on the clothes.
- Before washing, ensure that all pockets are empty and buttons and zips are fastened. Avoid washing frayed or torn articles and treat stains such as paint, ink, rust, and grass before washing. Underwired bras must **NOT** be machine washed.
- Any objects such as coins, safety pins, nails, screws, stones or any other hard, sharp material can cause extensive damage and must not be placed into the machine.
- Garments which have been in contact with volatile petroleum products should not be machine washed. If volatile cleaning fluids are used, care should be taken to ensure that the fluid is removed from the garment before placing in the machine.
- Wash small items such as socks, laces, washable belts etc in a washing bag or pillow case as it is possible for such items to slip down between the tub and the inner drum.
- Only use the advised quantities of fabric softener. Damage to the fabric can ensue if you over-fill. Refer to the manufacturer's recommendations of quantities.
- As some duvets and eiderdowns should be washed in large commercial machines because of their bulk, please check with the manufacturer of the item before washing in a domestic machine.

Maintenance and Cleaning

- For information on maintenance and cleaning your washing machine see pages 24 - 25 of this instruction manual.

Service

- This product should only be repaired or serviced by an authorised Service Engineer and only genuine approved spare parts should be used.

Ecological hints

To save water and energy and help protect the environment, we recommend that you follow these hints:

- Normally soiled laundry may be washed without prewashing in order to save detergent, water and time (the environment is protected too!).
- The machine works more economically if it is fully loaded.
- With adequate pre-treatment, stains and limited soiling can be removed; the laundry can then be washed at a lower temperature.
- Measure out detergent according to the water hardness, the degree of soiling and the quantity of laundry being washed.

Environmental Information

- After unpacking please dispose of packaging with due regard to safety and the environment.
- Materials marked with the symbol  are recyclable.
- Check with your local Council or to see if there are facilities in your area for recycling this appliance.

WARNING:



A cut off plug inserted into a 13 amp socket is a serious safety (shock) hazard. Ensure that the cut off plug is disposed of safely.

The symbol  on the product or on its packaging indicates that this product may not be treated as household waste. Instead it should be taken to the appropriate collection point for the recycling of electrical and electronic equipment. By ensuring this product is disposed of correctly, you will help prevent potential negative consequences for the environment and human health, which could otherwise be caused by inappropriate waste handling of this product. For more detailed information about recycling of this product, please contact your local council, your household waste disposal service or the shop where you purchased the product.

Contents

For the User

Important Safety Information	2-3
Installation	2
Child safety	2
Description of the Appliance	5
Detergent dispenser drawer	5
Child safety feature	5
The Control Panel	12-16
Programme information	16
Using the washing machine	17-19
Load the laundry	17
Measure out the detergent	17
Measure out the fabric softener	17
Switch the machine on	17
Select the desired programme/temperature	17
Select the spin speed or the “None” option	18
Select the desired options	18
Select the “Delay start”	18
Start the programme	18
How to change an option or a programme during its cycle	19
How to interrupt a programme	19
How to open the door during the cycle of a programme	19
End of programme	19
Hints & Tips on Washing	20
Wash Care Symbols	21
Washing Programmes	22-23

For the Installer

Installation	6
Technical Specifications	6
Unpacking	7
Positioning	7
Installation on a suspended floor	7
Plumbing in	8
Water inlet	8
Water drainage	8-9
Levelling	9
In the interest of the environment	10
Electrical connection	11
Permanent connection	11
Maintenance and Cleaning	24-25
Descaling	24
After each wash	24
Maintenance Wash	24
External cleaning	24
Cleaning the dispenser drawer	24
Cleaning the drawer recess	24
Cleaning the pump	24-25
Cleaning the water inlet filter	25
The dangers of freezing	25
Emergency emptying out	25
Something Not Working	26-27
Repairs - After Sales Service	27

Guide to use the Instruction Manual

The following symbols will be found in the text to guide you throughout the instructions:



Safety instructions



Hints and tips



Environmental information



This appliance complies with the following E.E.C. Directives:

- 73/23 EEC of 19.2.73 (Low Voltage Directive) and subsequent modifications;

- 89/336 EEC of 3.5.89 (Electromagnetic Compatibility Directive) and subsequent modifications.

Description of the appliance

Your new washing machine is fitted with an automatic device which detects the laundry amount in some programmes for cotton and synthetic items and chooses the best cycle parameters for washing in an economical way.



Cycle time duration, energy and water consumptions are proportional to the amount of each load.

This is ideal when washing different small quantities of laundry.

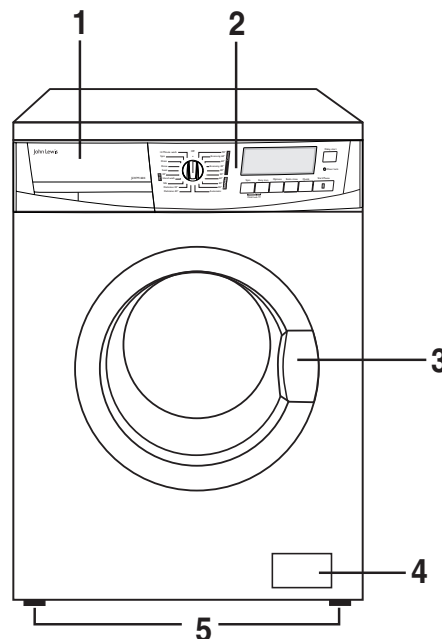
- 1 Detergent dispenser drawer
- 2 Control panel
- 3 Door handle
- 4 Drain pump
- 5 Adjustable feet



Detergent dispenser drawer

-  Prewash
-  Main wash
-  Fabric softener

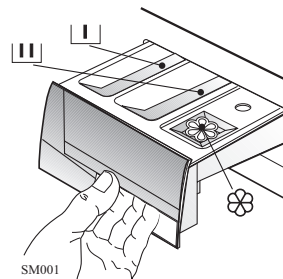

Child safety feature



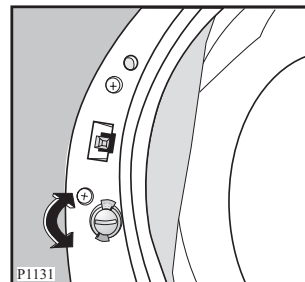

This machine incorporates a special child safety feature to prevent small children from being trapped inside the machine.

To activate this device, rotate the button (without pressing it) inside the door clockwise until the groove is horizontal. If necessary use a coin. This prevents the door from being closed.

To disable this device and restore the possibility of closing the door, rotate the button anti-clockwise until the groove is vertical.



Installation

-  It is dangerous to alter the specifications or attempt to modify this product in any way.
-  Care must be taken to ensure that the appliance does not stand on the electrical supply cable.
-  Any electrical work required to install this appliance should be carried out by a qualified electrician or competent person.
-  Any plumbing work required to install this appliance should be carried out by a qualified plumber or competent person.

Technical specifications

DIMENSIONS	Height Width Depth	85 cm 60 cm 63 cm
POWER SUPPLY VOLTAGE TOTAL POWER ABSORBED		230-240 V/50 Hz 2050 W (10A)
WATER PRESSURE	Minimum Maximum	0.05 MPa (0.5 bar) 0.8 MPa (8 bar)
MAXIMUM RECOMMENDED LOAD	Cotton, linen Synthetics Automatic Delicate fabrics Silk Wool/Hand wash 14 Minute wash	7 kg 3.5 kg 4 kg 3.5 kg 1 kg 2 kg 1 kg
SPIN SPEED	Maximum	1600 rpm
CONSUMPTION DATA FOR WASHING 7 KG NORMALLY SOILED COTTON ITEMS WITH PROGRAMME “ COTTONS ECONOMY 60° ”:	Energy Water	1.19 kWh 45 litres

Unpacking

-  All transit bolts and packing must be removed before using the appliance.
Keep all packaging away from children.

You are advised to keep all the transit bolts for re-use in case the machine is to be transported again.

After removing all the packaging, with assistance carefully lay machine on it's back to remove the polystyrene base from the bottom.

Remove the power supply cable and the draining hose from the hose holders on the rear of the appliance.

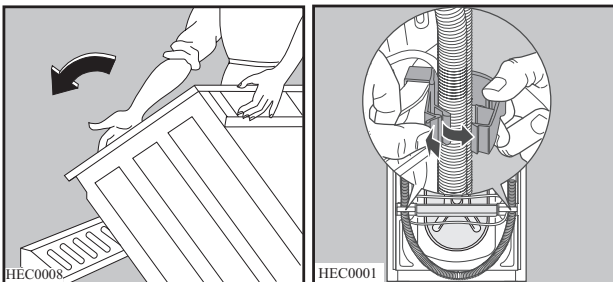

With the spanner provided unscrew and remove the central rear bolt **A**.

Unscrew and remove the two large rear bolts **B** and the six smaller bolts **C**.

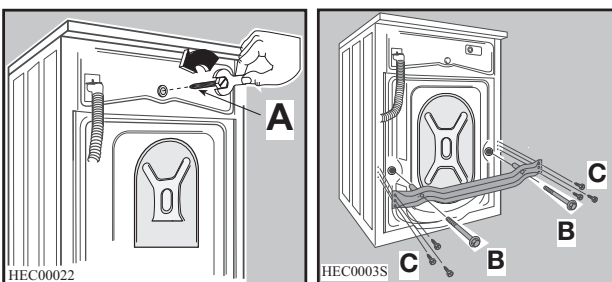

Remove the bracket **D**, refit the six smaller bolts **C** and slide out the relevant plastic spacer **E**.

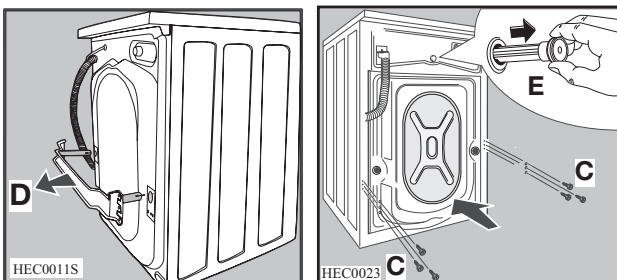

Open the porthole and remove the polystyrene block fitted with the adhesive tape.

Fill the smaller upper hole and the two large ones with the corresponding plastic plug caps supplied in the bag containing the instruction booklet.

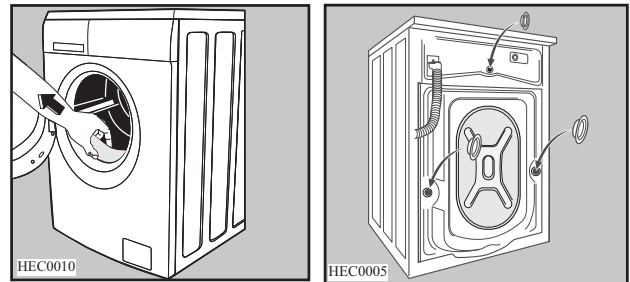

Connect the water inlet hose as described under the paragraph "Water inlet".

Positioning

Install the machine on a flat hard floor.

Make sure that air circulation around the machine is not impeded by carpets, rugs etc. Check that the machine does not touch the wall or other kitchen units.

Never place cardboard, wood or similar materials under the machine to compensate for any unevenness in the floor.

If the floor is carpeted or covered with crumbly or soft material, insert a rigid support base under the feet to prevent noise, vibration or displacement. The base should protrude a few centimetres beyond the edges of the machine.

-  **Warning**
The machine should NOT be placed on deep pile carpeting.

Installation on a Suspended Floor

Suspended wooden floors are particularly susceptible to vibration. To help prevent vibration we recommend you place a waterproof wood panel, at least 15 mm thick under the appliance, secured to at least 2 floor boards with screws. If possible install the appliance in one of the corners of the room, where the floor is more stable.

Note

Please ensure that when the appliance is installed it is easily accessible for the engineer in the event of a breakdown.

Plumbing In

Your new washing machine has been designed to be permanently plumbed in to your home's water supply and drainage system. However, if this is not possible, it may be connected to a suitable existing tap with the drain hose discharging into a sink.

The appliance has an inlet hose, with female 3/4" BSP thread connector. If this connection is not compatible with the plumbing of the existing installation, a variety of connectors are available from good hardware stores and plumbers merchants to suit most domestic plumbing. Any alteration to your existing plumbing must be carried out by a competent person, or qualified plumber.

Water inlet

An inlet hose is supplied and can be found inside the machine drum.

Do not use the hose from your previous washing machine to connect to the water supply.

1. Open the porthole and extract the inlet hose .
2. Connect the hose with the angled connection to the machine.

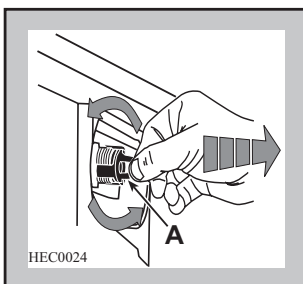

3. Remove the security gasket cup by turning and pulling it away. Pay attention not to move or remove the gasket.

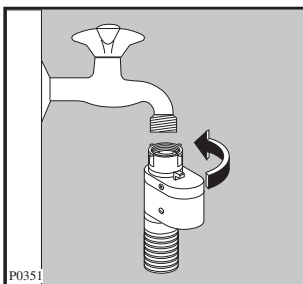

Important!

Do not place the inlet hose downwards. Angle the hose to the left or right depending on the position of your water tap.

4. Set the hose correctly by loosening the ring nut. After positioning the inlet hose, be sure to tighten the ring nut again to prevent leaks.

5. Connect the hose to a tap with a 3/4" thread. Always use the hose supplied with the appliance.

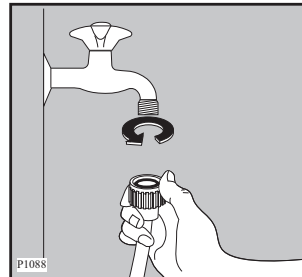

The inlet hose is provided with a water stop device, which protects against damage caused by water leaks in the hose which could develop due to natural ageing of the hose. This fault is shown by a red sector in the window "A". Should this occur, turn the water tap off and refer to your Service Centre to replace the hose. Installation should comply with local water authority and building regulations' requirements.

The appliance must be connected to a cold water supply.

A minimum water pressure of 0.5 bar is required for safe operation of the appliance.

If you cannot make the cold water connection direct from the rising mains, you may be able to operate the appliance from your cold water storage system.

There should be a minimum vertical distance of 5.02m (16.5 ft) between the appliance's inlet and the bottom of the water storage tank.

Water drainage

This appliance is designed to be permanently plumbed into your home's drainage system using one of the following methods.

I. Into a drainage standpipe.

Firstly form a hook in the end of the drain hose using the "U" piece supplied.

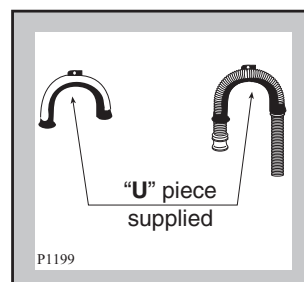

Place the drain hose into your standpipe, which should have an internal diameter of approximately 38mm thus ensuring there is an air break between the drain hose and standpipe.

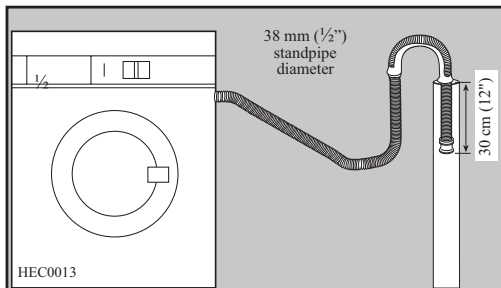

When discharging into a standpipe ensure that the top of the standpipe is no more than 90cm (35.4") and no less than 60cm (23.6") above floor level.

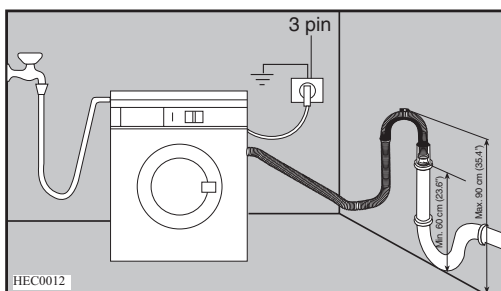

The drain hose may be extended to a maximum of 4 metres. An additional drain hose and joining piece is available from your local Service Force Centre. The joining piece must have an internal diameter of 18mm.

If your drain hose looks like this (see below) you do not require the "U" piece". Just push the hose firmly into the standpipe.

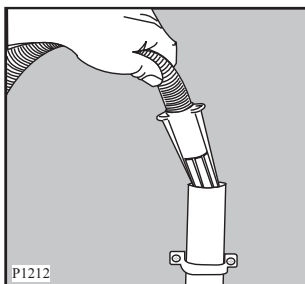

2. Onto a sink outlet spigot.

If the outlet spigot has not been used before, remove any blanking plug that may be in place.

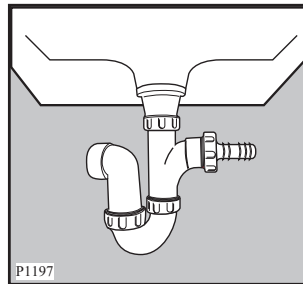

Push the drain hose onto the spigot and secure with a clip if required, ensure a loop is formed in the drain hose (see diagram) to prevent waste from the sink entering the washing machine.

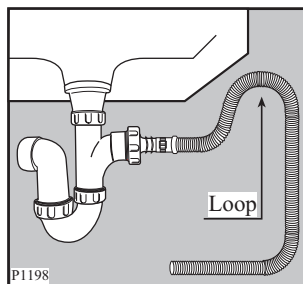

Important

Before connecting the machine to new pipework or to pipework that has not been used for some time, run off a reasonable amount of water to flush out any debris that may have collected in the pipes.

Levelling

Level the washing machine by raising or lowering the feet. The feet may be tight to adjust as they incorporate a self locking nut, but the machine **MUST** be level and stable. If necessary, check the setting with a spirit level.

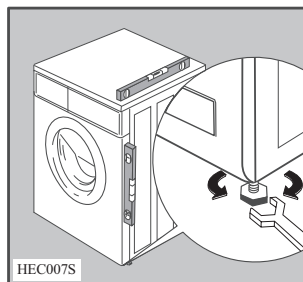

Any necessary adjustment can be made with a spanner. Accurate levelling prevents vibration, (see note on positioning), noise and displacement of the machine during operation.

Some vibration is inevitable, especially if mounted on a wooden floor.

Sprung wooden floors are particularly susceptible to vibration. For advice, consult a builder. If possible, always place the machine on a solid floor.

In the interest of the environment

Washing machines and dishwashers should be connected to the FOUL drainage system, the water will then be taken to a sewage works for treatment before being discharged safely into a river.

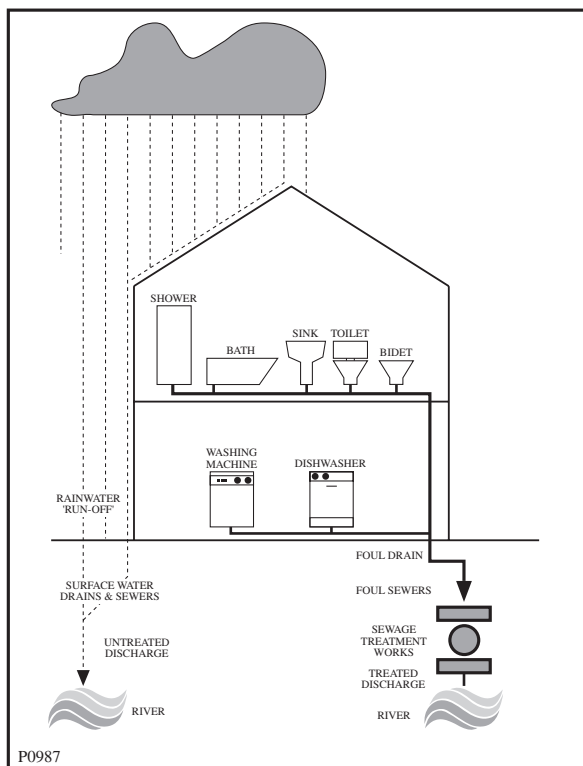

It is essential that these appliances are not connected to the surface water drainage system as this water is discharged directly into a river or stream and may cause pollution.

If you require any further advice please contact your local water authority.

Electrical connection

Any electrical work required to install this appliance should be carried out by a qualified electrician or competent person.



WARNING: THIS APPLIANCE MUST BE EARTHED.

The manufacturer declines any liability should this safety measure not be observed.

Should the appliance power supply cable need to be replaced, this must be carried out by a Service Force agent (see page 27).

Before switching on, make sure the electricity supply voltage is the same as that indicated on the appliance's rating plate. The rating plate is located at the top of the rim of the open door.

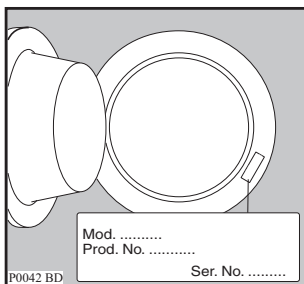

The appliance is supplied with a 13amp plug fitted. In the event of having to change the fuse in the plug supplied, a 13amp ASTA approved (BS1363/A) fuse must be used.

Should the plug need to be replaced for any reason, proceed as described below.

The wires in the mains lead are coloured in accordance with the following code:

Green and Yellow	- Earth
Blue	- Neutral
Brown	- Live

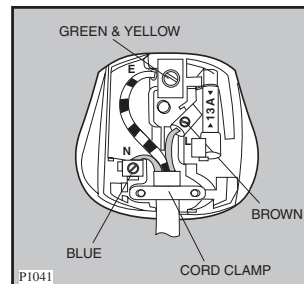

If you fit your own plug, the colours of the wires in the mains lead of your appliance may not correspond with the markings identifying the terminals in your plug.

Proceed as follows:

1. The wire coloured green and yellow must be connected to the terminal marked with the letter «E» or by the earth symbol \perp or coloured green and yellow.
2. The wire coloured blue must be connected to the terminal marked «N» or coloured black.
3. The wire coloured brown must be connected to the terminal marked «L» or coloured red.
4. Upon completion there must be no cut, or stray strands of wire present and the cord clamp must be secure over the outer sheath.

WARNING:



A cut off plug inserted into a 13 amp socket is a serious safety (shock) hazard. Ensure that the cut off plug is disposed of safely.



The power supply cable must be easily accessible after installing the appliance.



The appliance should not be connected to the electrical supply by means of an extension cable.

Permanent connection

In the case of permanent connection it is necessary that you install a double pole switch between the appliance and the electricity supply (mains), with a minimum gap of 3mm between the switch contacts and of a type suitable for the required load in compliance with the current electrical regulations.

The switch must not break the yellow and green earth cable at any point.

The control panel

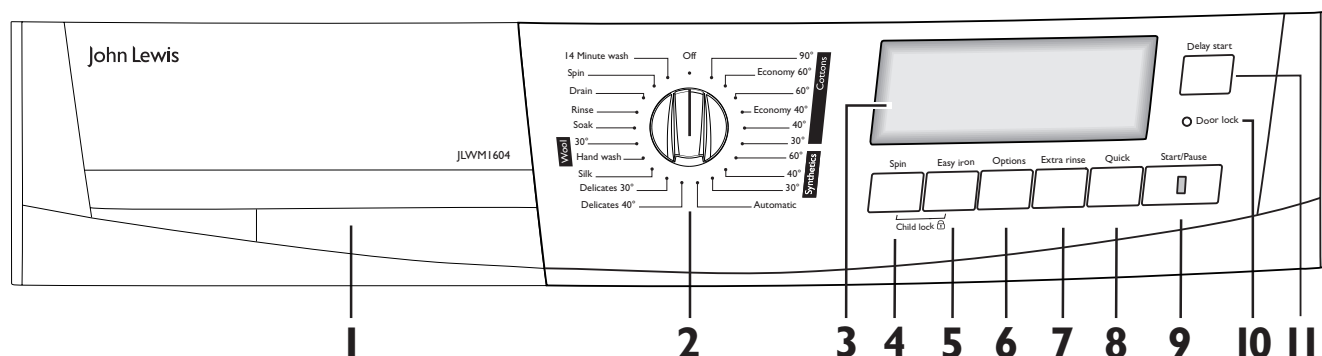

1 Detergent dispenser drawer

2 Programme selector dial

The programme selector dial is divided into the following sections:

- Cottons
- Synthetics
- Delicates / Silk
- Wool / Hand washing
- Special programmes from “Soak” to “14 Minute wash”
- Reset/Off programme **Off**

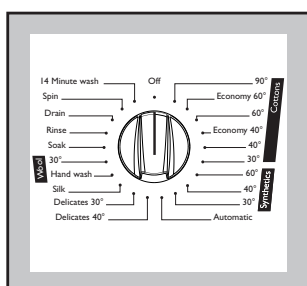

The selector dial can be turned either clockwise or anticlockwise.

“**Economy**” position corresponds to an ENERGY SAVING programme.

Before setting the dial to any position ensure that the machine is turned to the “**Off**” position.

IMPORTANT!

At the end of the programme the selector dial must be turned to position “Off”, to switch the machine off.

Attention!

If you turn the programme selector dial to another programme when the machine is working, the **red** Start/Pause pilot light will flash 3 times and the message **Err** is displayed on the display to indicate a wrong selection. The machine will not perform the new selected programme.

3 Display

The following pieces of information are shown on the display:

- **Duration of washing programme** in hours and minutes, after you have selected a programme.



While the programme is running (after you have pressed the Start/Pause button), the displayed time value decreases by one unit every minute.

Attention!

When selecting the «**proportional**» programmes, the display shows the washing duration of the maximum recommended load. After the Start/Pause has been pressed, on the display the «**Wash time**» starts flashing to indicate that the appliance is calculating the laundry amount and the real duration. During this time, the washing duration shown decreases.



When the calculating phase has finished, the «**Wash time**» stops flashing and the washing time is adjusted to the real load.

- **The washing machine has completed the programme:** this is indicated by a **flashing zero**. The “**Door lock**” pilot light and the Start/Pause light go out and the door can be opened.

- **The washing machine has stopped with water in the tub**, at the end of the “Soak” or of a programme with the “Rinse hold” or “Quiet” option: this is indicated by a **flashing zero**. The Start/Pause light goes out but the “Door lock” pilot light is still on. The door cannot be opened.



If your laundry is not removed during 10 minutes after the programme has finished, all pilot lights and the display switch off and the energy saving system will be enabled. Only the green Start/Pause light flashes to indicate that the appliance has to be switched off.

- **Delay start**, a time value indicated in hours and minutes and selected by pressing the delay start button.



The delay time (20 hours max) is displayed for 3 seconds, then the duration of the selected programme reappears.

After you have pressed the Start/Pause button, the countdown is updated every hour, and, for the last hour, every minute.

- **An incorrect option selection has been made:** this is indicated by the message **Err** for about 2 seconds when an option incompatible with the current programme is selected.



- **An alarm code** indicates a fault with the machine (see the relevant chapter).



4 “Spin” button

Press this button repeatedly to change the spin speed if you want your laundry to be spun at a speed different from the one proposed by the washing machine.

Maximum speeds are:

- Cottons, linen: 1600 r.p.m.;
- “Automatic” programme: 1600 r.p.m. ;
- Synthetics and 14 Minute wash: 900 r.p.m.;
- Wool and Handwash: 1000 r.p.m.;
- Delicates and Silk: 700 r.p.m.

By pressing the Spin speed button you can also choose **No Spin** option «U», **Rinse Hold** option «Rinse hold» and **Quiet** option «Quiet».

No spin «U» option eliminates all the spin phases and increases the number of rinses for Cottons, Synthetics, Delicates, Silk and Automatic.

Rinse hold position **Rinse hold**: when you choose this option, the machine will not drain the water of the last rinse, so as not to crease the laundry. The selected option will be displayed.

Quiet position **Quiet**: when you choose this option, the machine will not drain the water of the last rinse, so as not to crease the laundry. The selected option will be displayed.

As all spinning phases are cancelled, this washing cycle is very quiet and it can be selected at night or in times with a more economical power rate.

On cotton, synthetic, delicates, silk and Automatic programmes the rinses will be performed with more water.

If the Rinse Hold or Quiet option has been selected the “Door lock” light is on, the “Start/Pause” button light goes out and the display shows a flashing «U».

The door cannot be opened because the water must be drained.

To empty out water there are 2 options:

- Select “Drain” programme and press the “Start/Pause” button: the water is emptied out without spinning.
- Select “Spin” programme. Select the spin speed by means of the relevant button and then press the “Start/Pause” button. The water is emptied out and the laundry is spun at the selected spin speed.

Attention!

Before selecting “Drain” programme or “Spin” programme the selector dial must first be turned to the «Off» position.

Child lock

This function works in two different ways:

- If enabled before the «**Start/Pause**» button is pressed, it prevents the machine from being started.
- If enabled after pressing the «**Start/Pause**» button, it prevents any changes being made to the programmes or options selected.

To enable or disable this function, press the «Spin» and «Easy Iron» buttons simultaneously for approx 6 seconds until the icon  appears on or disappears from the display.



Programme option buttons

Depending on the programme, different options can be selected together. These must be selected after choosing the desired programme and before pressing the «**Start/Pause**» button.

If an option which is not compatible with the set wash programme is selected, the red **Start/Pause** light flashes 3 times and the message **Err** is displayed for about 2 seconds.

5 “Easy Iron” button

By pressing the “**Easy Iron**” button, the symbol icon , will appear in the display. By selecting this button the laundry will be gently washed and spun to avoid any creasing. In this way ironing is easier. Furthermore the machine will perform 6 rinses instead of 3 for cotton and 4 rinses instead of 3 for synthetic programmes and Automatic. This function can be used for cotton and synthetic fabrics. If this option is selected for cotton programmes and Automatic, the spin speed will automatically reduce to 900 rpm.

6 Option buttons (Prewash / Stain / Intensive)

Press this button repeatedly, to select only one of the following options:

- **Prewash**: select this option if you wish your laundry to be prewashed before the main wash (**not available for Wool, Silk, Soak and 14 Minute wash**).

The prewash ends with a short spin in programmes for cotton and synthetic fabrics, whereas in the programme for delicate fabrics the water is only drained.

This option can be selected for heavily soiled laundry.

- **Stain**: select this option if you wish to add a stain phase to the washing of heavily soiled laundry. Pour a stain removing detergent into the compartment marked .

This function is available in cotton, synthetic, Automatic and delicates programmes with a temperature of 40° or higher.

The washing time will be prolonged by few minutes.

- **Intensive**: select this option for heavily soiled laundry. If you press this button the washing intensity will be increased and the washing time will be prolonged by approx. 10 minutes. This option is **not available** for Economy, Delicates, Wool, Silk, Soak and 14 Minute wash programmes and in combination with «**Quick**» option.

7 “Extra rinse” button

By pressing the “**Extra Rinse**” button, the symbol , will appear in the display. This option can be selected with all programmes, except the Wool, Handwash, Silk, Soak programmes and 14 Minute wash. The machine performs some additional rinses. This option is recommended for people who are allergic to detergents, and areas where the water is very soft.

8 “Quick” button

By pressing this button, the option description will appear in the display. This option can be used for lightly soiled (not for Wool, Handwash, Silk, 14 Minute wash and Economy programmes) in order to obtain a good washing result in a short time. The washing time will be reduced according to the type of fabric and the selected temperature (Max recommended load = 3.5 kg for Cottons and 1.5 Kg for Synthetics and Delicates). «**Quick**» cannot be used in combination with the «**Intensive**» option.

9 Start/Pause button

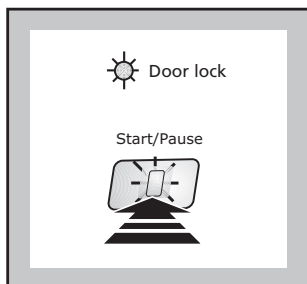

To start the selected programme, press the **Start/Pause** button; the green pilot light stops flashing. If you have selected a delay time, the countdown will begin and will be shown on the display.

To interrupt a programme which is running, press the **Start/Pause** button: the green pilot light starts to flash.

To restart the programme from the point at which it was interrupted, **press** the Start/Pause **button again**.

If an incorrect option is selected, the **red** pilot light for the Start/ Pause button flashes 3 times and the message **Err** is displayed for about 2 seconds.

Important! You must set the washing machine to Pause before you make any change in the programme in progress.

10 “Door lock” light

This pilot light illuminates to indicate that the appliance starts operating and the door is locked. It stays on during the whole programme.

When the light goes out, the door can be opened.

The **“Door lock”** pilot light indicates if the door can be opened:

- Light on: the door cannot be opened. The appliance is running.
- Light off: the door can be opened. The washing programme is finished.

When you PAUSE the cycle, it becomes possible to open the door, provided:

- The washing machine is not in the heating phase;
- The level of the water is not high;

If all these requirements are met, the “Door lock” light goes off.

11 “Delay start” button



Before you start the programme, if you wish to delay the start, press the Delay Start button repeatedly, to select the desired delay.

The selected delay time value (up to 20 hours) will appear on the display for about 3 seconds, then the duration of the programme will appear again.

The wash programme can be delayed from 30 min - 60 min - 90 min, 2 hours and then by 1 hour up to a maximum of 20 hours by means of this button.

If you wish to add laundry in the machine during the delay time you will press Start/Pause button to put the machine in pause. Add the laundry, close the door and press Start/Pause button again.

You can cancel the delay time at any moment, before you press the Start/Pause button.

Selecting the delayed start

You must select this option after you have set the programme and before you press the **Start/Pause** button.

- Select the programme and the required options.
- Select the delay start.
- Press Start/Pause button: the machine starts its hourly countdown.

The programme will start after the selected delay has expired.

Cancelling the delayed start

- Press **Start/Pause** button.
- Press **“Delay start”** button once until the symbol «U» is displayed.
- Press **“Start/Pause** button again.

The Delay Start **cannot** be selected with **“Drain”** programme.

Important!

The door will be locked throughout the delay time. If you need to open the door, you must first set the washing machine to Pause by pressing the **Start/Pause** button. After you have closed the door, press the **Start/Pause** button again.

Acoustic Signal

At the end of a washing cycle and in case of operating problems, an acoustic signal will sound.

You can deactivate the acoustic signal by pressing the "Options" and the "Extra rinse" buttons

simultaneously for about 5 seconds.

By pressing these buttons again the acoustic signal is reactivated.

Programme information

Automatic

By selecting this programme coloured cotton and synthetics items can be washed together.

Washing temperature 40°C.

Max. load 4 kg.

Final spin speed 1600 rpm. The spin speed can be reduced by pressing the «Spin» button.

The duration of the washing cycle is calculated according to the type of loaded laundry.

Silk

Delicate washing programme suitable for silk and mixed synthetics items.

Max. load 1 kg.

Washing temperature is 30°C.

The maximum spin speed is automatically reduced to 700 rpm.

Soak

This is a special programme for heavily soiled laundry. The machine performs a soak at 30°C.

At the end of the soak time the machine will stop automatically **with water left in the tub**. The display will show a flashing zero. The "**Door lock**" light is on. Pour the detergent for the soak programme into the compartment marked .

Before starting a new washing phase, it is necessary to empty the water by selecting the "**Drain**" programme.

This programme **cannot** be used for very delicate fabrics as silk or wool.

Rinse

With this programme it is possible to rinse and spin garments which have been washed by hand. The machine performs 3 rinses, followed by a final long spin at the maximum speed.

Important!

The spin speed will automatically assume the setting for cotton items. If required, reduce the speed to the desired level by pressing the "**Spin**" button.

Drain

To empty out the water of the last rinse in programmes with the "**Rinse hold**" or "**Quiet**" option or the "**Soak**" programme. First turn the programme selector dial to "**Off**", then select the "**Drain**" programme and press the "**Start/Pause**" button.

Spin

Separate long spin at the max speed for hand washed garments. The spin speed will automatically assume the setting for cotton items. You can reduce the speed by pressing the "**Spin**" button to adapt it to the fabrics to be spun.

14 Minute wash

This is a complete programme that can be combined with the following options: "**Rinse hold**", "**Spin**" speed reduction, "**No Spin**" and "**Delay start**".

To be used for laundry which is lightly soiled or which needs freshening up.

Max. load 1 kg.

Washing temperature 30° C.

Programme duration 14 minutes.

Final spin speed 900 rpm.

Off = Reset / Switching the machine off

To reset a programme or to switch the machine off, turn the selector dial to "**Off**".

Now a new programme can be selected.

i Using the washing machine

Before the first wash, we recommend that you run a cotton cycle at 90°C, without any laundry in the machine, to remove any manufacturing residue from the drum and tub. Pour 1/2 a measure of detergent into the dispenser drawer and start the machine.

WASHING 7 KG OF WHITE COTTON AT 90°C

Suppose you have 7 kg of laundry to wash. It is white cotton and is suitable for high temperature washing.

1. Load the laundry

Open the door. Place the laundry in the drum, one item at a time, shaking them out as much as possible. Close the door.

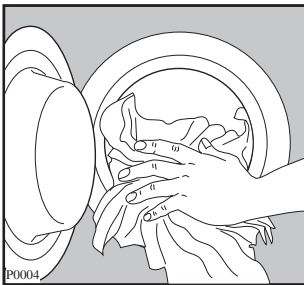

2. Measure out the detergent

Pull out the dispenser drawer until it stops. Measure out the amount of detergent required and pour it into the main wash compartment [II].

If you wish to carry out the prewash, a soak programme or a stain phase, pour detergent or stain remover into the appropriate compartment marked [I].

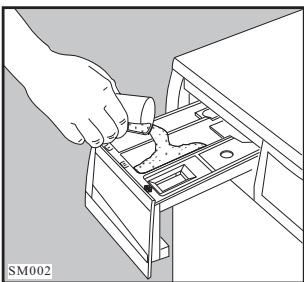

Important!

Do not use normal detergent for the “Stain” option, always use a STAIN remover.

3. Measure out the fabric softener

If required, pour fabric softener into the compartment marked , without exceeding the «MAX» mark.

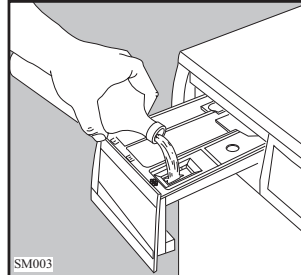

Close the drawer gently.

4. Switch the machine on

Turn the selector dial to any programme to switch the machine on. The **Start/Pause** light starts to flash and the display shows the duration of the selected programme.

To switch the appliance off turn it to “Off”.

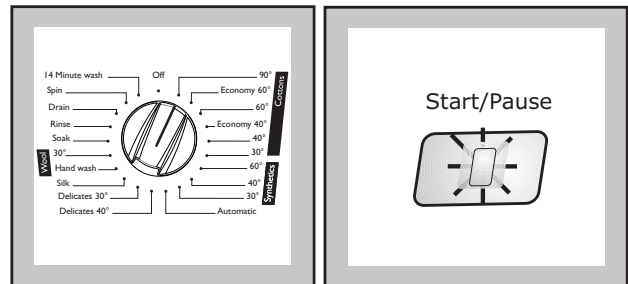

5. Select the desired programme/temperature

Turn the selector dial to the desired position (Cottons 90° in this case).

The display will show the duration of the selected programme, calculated on the basis of the maximum load for each type of fabric. The **Start/Pause** button light will start flashing.



If your laundry needs a soak time, turn the programme selector dial to “Soak” and then, before starting a washing cycle, drain the water as described in the “Soak” paragraph.

6. Select the spin speed, “No Spin”, “Rinse hold” or “Quiet” option

Press the “**Spin**” button repeatedly in order to select the desired spin speed, “No Spin”, “Rinse hold” or “Quiet” option.

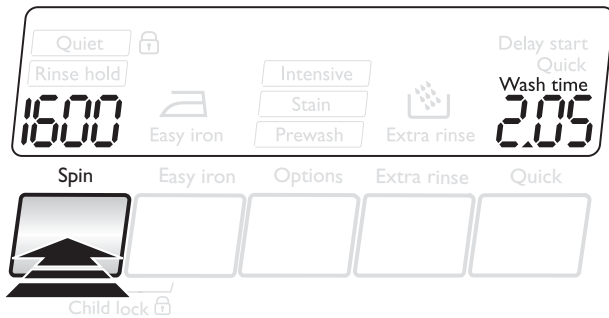

7. Select the “Easy Iron” option

When this option is selected, the laundry will be gently washed and spun to avoid creasing.

The relevant symbol icon will appear in the display.

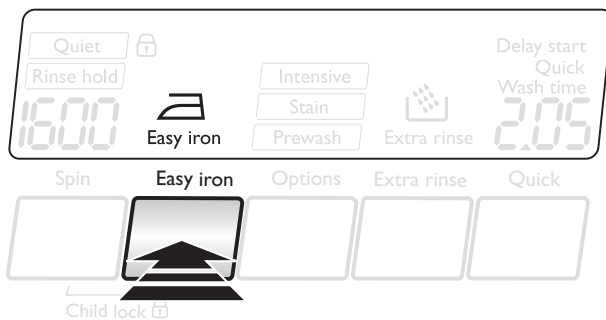

8. Select the desired options

If your laundry is very dirty, it may be advisable to select the “**Prewash**”, “**Stain**” or “**Intensive**” option. If your laundry has heavy stains and it is necessary to prolong the washing time, select the “**Stain**” option. The special detergent for stains (Stain remover) is loaded from the compartment marked **U**.

The selected option will be displayed in the relevant rectangle.

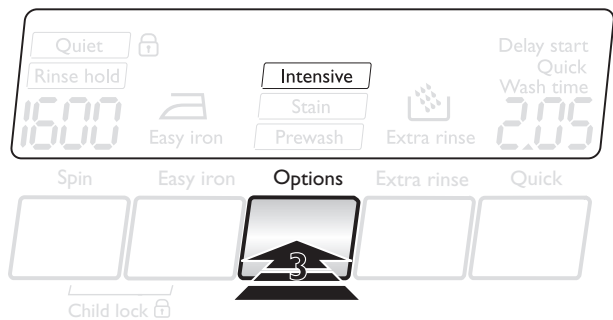
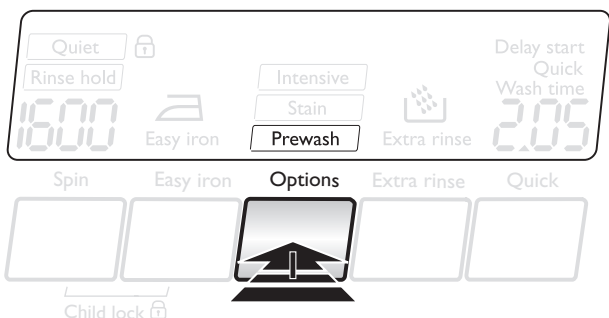

9. Select the “Delay start”

Before you start the programme, if you wish the start to be delayed, press the “**Delay Start**” button repeatedly, or keep it pressed, to select the desired delay. The selected delay time value (up to 20 hours) will appear on the display for 3 seconds, then the duration of the programme will appear again.



10. Start the programme

Press the “**Start/Pause**” button. The relevant green light will stop flashing.

If you have chosen a delayed start, the washing machine will begin the countdown.

The display will show the duration of the programme or the selected delay.

11. How to change an option or a programme during its cycle

It is possible to change any option before the programme carries it out. Before you make any change, you must pause the washing machine by pressing the **“Start/Pause”** button.

Changing a running programme is possible only by **resetting it**.

Turn the programme selector dial to **“Off”** and then to the new programme position. The washing water in the tub will not empty out.

Start the new programme by pressing the **“Start/Pause”** button.

12. How to interrupt a programme

Press the **“Start/Pause”** button to interrupt a programme which is running, the corresponding light starts to flash. Press the button again to restart the programme.

13. How to open the door during the cycle of a programme

You can open the door, after having set the washing machine to Pause, provided the following conditions exist:

- The washing machine is not in the heating phase beyond 55°C;
- The level of the water is not high;

If these requirements are met, when you pause the washing machine, the **“Door lock”** light goes off and the door can be opened.

Should it not be possible to open the door, and should it be absolutely necessary to do so, switch the machine off by turning the selector dial to **“Off”**.

After approximately 3 minutes, you can open the door.

Pay attention to the level and temperature of the water in the washing machine!

When you close the door to restart the programme turn the dial to the previous programme repeating the options previously selected and press Start/Pause button.

14. End of programme

At the end of the programme, the washing machine stops automatically, the **“Start/Pause”** button light and the **“Door”** light go off, the display shows a flashing zero «0». It is possible to open the door.

If you had selected the **“Rinse hold”** or **“Quiet”** option, the **“Door lock”** light remains lit to indicate that the door is locked and the water must be drained.

To **drain or to spin** see paragraph **“Quiet”** on page 13.

Turn the programme selector dial to Reset **“Off”** to switch the machine off.

Remove the laundry from the washing machine.

Check whether the drum is completely empty, by rotating it with your hand. The purpose of this is to prevent any items of laundry from remaining accidentally in the drum, where they might get damaged in a subsequent wash (e.g. by shrinking) or bleed colour into another load of laundry.

We advise you to close the water supply tap and disconnect the plug from the socket.

Leave the door ajar in order to air the washing machine.

Hints & tips on washing

Do **NOT** overload the machine. Weigh the laundry the first few times you use the appliance.

The average weights of the most common items are listed below as a guide:

1000g = 1 kg

Sheet	700-1000 g
Pillow case	100-200 g
Tablecloth	400-500 g
Serviette	50-100 g
Tea towel	70-120 g
Linen hand towel	100-150 g
Towelling hand towel	150-250 g
Towelling bath towel	700-1000 g
Bath robe	1000-1500 g
Man's shirt	200-300 g
Apron	150-200 g

- Load the laundry loosely alternating large items with small ones.
- Sort the laundry according to the type of fabric, colour-fastness and how dirty it is.
- Avoid washing unhemmed or torn items as they may unravel.
- Before washing, empty all pockets of small objects which may have been left inside (coins, keys, screws etc). as these could damage the drain pump.
- When washing curtains, remove the hooks.
- Close poppers and zips and fasten loose buttons.
- It is essential to wash new coloured items separately when washing for the first time.

- When washing fabrics requiring different wash temperatures together, always select the lowest temperature.
- White items should not be washed with coloured items.
- Very small items (handkerchiefs, ribbons, socks etc) should be washed in a washing bag or a pillow case.
- Use a good quality detergent suitable for automatic washing machines.
- Use the correct quantities of detergent.
- For wool, use gentle detergent only in small quantities.
- Bleach is very corrosive; it should be used with care and kept out of reach of children.
- Some stains such as fruit, wine, grass, rust etc. are difficult to remove and should be treated before washing with specific products, which can be found in most household shops. In some cases it may help to soak the stain before washing with a special pre-soak product or biological detergent.
- If you have used the machine to wash, rinse or spin only non-colour fast garments, there may be dye left in the sump. To ensure any subsequent wash is not contaminated with the dye, select and carry out a rinse and spin programme, without any garments, to ensure that any dye is removed from the sump.
- Once you have finished using the machine, you are advised to unplug it and turn off the water tap.

Wash care symbols

Wash care labels inside garments recommend how to launder your clothes with the best results. The care labelling code is in line with care labelling used in the rest of Europe. The symbols used make it easy to select the correct programme on your washing machine.

WASHING SYMBOL	WASH ACTION	FABRIC
	Normal (Maximum)	White Cotton or Linen without Special Finishes
	Normal (Maximum)	Cotton, Linen or Viscose without Special Finishes Colourfast at 60°C.
	Reduced (Medium)	Nylon, Polyester/Cotton, Viscose with Special Finishes, Cotton/Acrylic Mix.
	Normal (Maximum)	Cotton, Linen or Viscose Colourfast at 40°C but not 60°C.
	Reduced (Medium)	Acrylics, Acetate, Triacetate, Wool mixes, Polyester/wool blends.
	Much Reduced (Minimum)	Wool, wool mixtures, Silks
	Hand wash only	Do not machine wash
BLEACHING		
	Chlorine bleach may be used	
IRONING		
	Hot iron	Cotton, Linen, Viscose
	Warm iron	Polyester mixtures, Wool
	Cool iron	Acrylic, Nylon, Polyester
DRY CLEANING		
	May be dry cleaned. Other letters and/or a bar beneath the circle will indicate the required process to the dry cleaner.	
TUMBLE DRYING		
	with high heat setting	
	with low heat setting	
	May be tumble dried	
	A cross through any symbol means «DO NOT»	

Important Notes

For best results, always use the dispenser drawer for dispensing detergents and liquid additives. Once the dispenser has been filled, close it by pushing it in gently. This is particularly important if you are using

fabric conditioner to avoid the conditioner entering the machine prematurely.

When using liquid detergent and a prewash programme, place the detergent into the correct compartment in the dispenser drawer, after the prewash has finished.

Washing programmes

Fabrics	Programme/ temperature	Type of laundry	Available options	Load	Consumptions*	
					Energy kWh	Water litres
White cotton ⁽¹⁾	90° Cottons	Sheets, household linen, towels, tablecloths	Spin reduction/No Spin/Rinse hold/Quiet, Easy Iron, Prewash, Intensive, Stain, Extra rinse, Quick	7 Kg	2.1	62
White cotton ⁽¹⁾	Economy 60° Cottons	Sheets, household linen, towels, tablecloths	Spin reduction/No Spin/Rinse hold/Quiet, Easy Iron, Prewash, Stain, Extra rinse	7 Kg	1.19	45
White and coloured cotton ⁽¹⁾	60° Cottons	Hand towels, sheets, underwear, tablecloths, shirts	Spin reduction/No Spin/Rinse hold/Quiet, Easy Iron, Prewash, Intensive, Stain**, Extra rinse, Quick	7 Kg	1.35	58
Coloured cotton ⁽¹⁾	Economy 40° Cottons	Coloured items, for example underwear, shirts, blouses	Spin reduction/No Spin/Rinse hold/Quiet, Easy Iron, Prewash, Stain, Extra rinse	7 Kg	1.03	45
White and coloured cotton ⁽¹⁾	40°-30° Cottons	Fast coloured and non-fast items, for example hand towels, sheets, underwear, tablecloths, shirts	Spin reduction/No Spin/Rinse hold/Quiet, Easy Iron, Prewash, Intensive, Stain**, Extra rinse, Quick	7 Kg	0.75	58
Synthetics ⁽¹⁾	60° - 40° - 30° Synthetics	Shirts, blouses, underwear, mixed fabrics	Spin reduction/No Spin/Rinse hold/Quiet, Easy Iron, Prewash, Intensive, Stain**, Extra rinse, Quick	3.5 Kg	0.9	54
Automatic	40°	Coloured cotton and synthetic items can be washed together	Spin reduction/No Spin/Rinse hold/Quiet, Easy Iron, Prewash, Intensive, Stain, Extra rinse, Quick	4 Kg	0.6	47
Delicates	40° - 30° Delicates	Acrylic, viscose, polyester items, curtains	Spin reduction/No Spin/Rinse hold/Quiet, Prewash, Stain**, Extra rinse, Quick	3.5 Kg	0.55	63
Silk	30°	Silk items to be gently washed and spun.	Spin reduction/No Spin/Rinse hold/Quiet	1 Kg	0.25	50
Hand wash Wool 	30°	Garments bearing the "Pure new wool, non-shrink, machine washable" or "Hand wash" label	Spin reduction/No Spin/Rinse hold/Quiet	2 kg	0.25	58

⁽¹⁾ *Cycle time duration, energy and water consumptions are proportional to the amount of load.*

The "**Economy Cottons 60°**" is the reference programme for the data entered in the energy label, in compliance with EEC 92/75 standards.

* This data is given purely as an indication: the consumption values may vary in relation to the quantity and type of laundry, the temperature of the water supply and the ambient temperature. The data refers to the highest temperature provided for each programme.

** Only at a temperature of **40°C or higher**.

Washing programmes

Programme	Programme description	Available options	Load	Consumptions*	
				Energy kWh	Water litres
Soak	Soak for 30 minutes at 30°C		7 Kg	0.4	23
Rinse	3 rinses Long spin at max. speed	Spin reduction/No Spin/Rinse hold/Quiet, Easy Iron, Extra rinse	7 Kg	0.1	46
Drain For emptying out the last rinse of the programmes with option " Rinse Hold ", " Quiet " and programme " Soak "	Water draining	-	7 Kg	-	-
Spin	Drain and long spin at max. speed**	Spin reduction	7 Kg	-	-
14 Minute wash Short cycle for lightly soiled fabrics	Wash at 30°C 2 rinses Short spin	Spin reduction/No Spin/Rinse hold	1 Kg	0.18	42
Off / (Reset)	For cancelling the programme which is running or to switch the machine off		-	-	-

** You can reduce the spin speed by means of the relevant button to adapt it to the fabrics to be spun.

For the duration of the programmes, please refer to the display on the control panel.

Maintenance and cleaning

You must DISCONNECT the appliance from the electricity supply, before you can carry out any cleaning or maintenance work.

Descaling

The water we use normally contains lime. It is a good idea to periodically use a water softening powder in the machine. Do this separately from any laundry washing, and according to the softening powder manufacturer's instructions. This will help to prevent the formation of lime deposits.

After each wash

Leave the door open for a while. This helps to prevent mould and stagnant smells forming inside the appliance. Keeping the door open after a wash will also help to preserve the door seal.

Maintenance wash

With the use of low temperature washes it is possible to get a build up of residues inside the drum. We recommend that a maintenance wash be performed on a regular basis.

To run a maintenance wash:

- The drum should be empty of laundry.
- Select the hottest cotton wash programme.
- Use a normal measure of detergent, must be a powder (such as Ariel Futur).

External cleaning

Clean the exterior cabinet of the appliance with soap and water only, and then dry thoroughly.

Cleaning the dispenser drawer

The washing powder and additive dispenser drawer should be cleaned regularly. Remove the drawer by pressing the catch downwards and by pulling it out. Flush it out under a tap, to remove any traces of accumulated powder. To aid cleaning, the top part of the additive compartment should be removed.

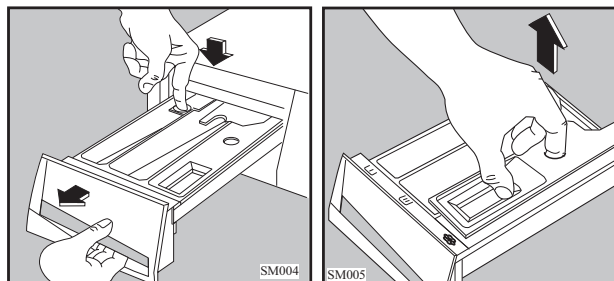

Cleaning the drawer recess

Having removed the drawer, use a small brush to clean the recess, ensuring that all washing powder residue is removed from the upper and lower part of the recess. Replace the drawer and run the rinse programme without any clothes in the drum.

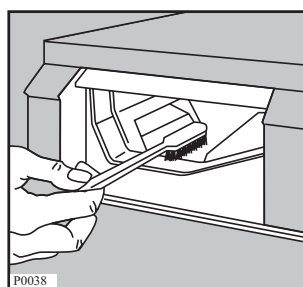

Cleaning the pump

The pump should be inspected if

- The machine does not empty and/or spin
- The machine makes an unusual noise during draining due to objects such as safety pins, coins etc. blocking the pump.

Proceed as follows:

- Disconnect the appliance.
- If necessary wait until the water has cooled down.
- Open the pump door.

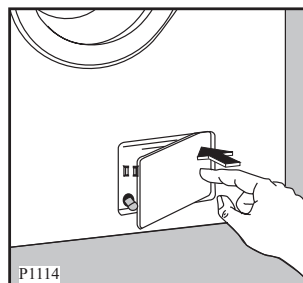

- Place a container close to the pump to collect any spillage.
- Pull out the emergency emptying hose, place it in the container and remove its cap.

- When no more water comes out, unscrew the pump cover and remove it. Always keep a rag nearby to dry up spillage of water when removing the cover.

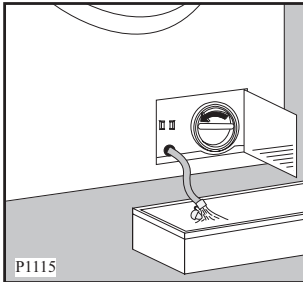

- Remove any objects from the pump impeller by rotating it.

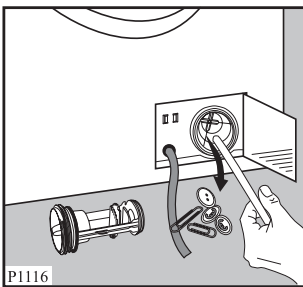

- Put the cap back on the emergency emptying hose and place the latter back in its seat.

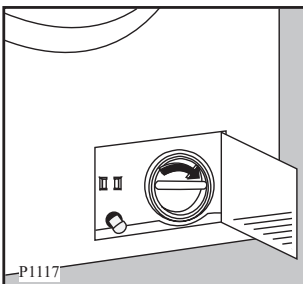

- Screw the pump cover fully in.
- Close the pump door.

Warning

When the appliance is in use and depending on the programme selected there can be hot water in the pump. Never remove the pump cover during a wash cycle, always wait until the appliance has finished the cycle, and is empty. When replacing the cover, ensure it is securely retightened so as to stop leaks and young children being able to remove it.

Cleaning the water inlet filter

If your water is very hard or contains traces of lime deposit, the water inlet filter may become clogged. It is therefore a good idea to clean it from time to time. Turn off the water tap. Unscrew the water inlet hose. Clean the filter using a hard bristle brush.

Tighten up the inlet hose.

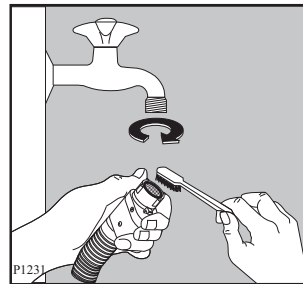

The dangers of freezing

If the machine is exposed to temperatures below 0°C, certain precautions should be taken.

- Turn off the water tap.
- Unscrew the inlet hose.
- Place the end of the emergency emptying hose and that of the inlet hose in a bowl placed on the floor and let water drain out.
- Screw the water inlet hose back on and reposition the emergency emptying hose after having put the cap on again.
- When you intend to start the machine up again, make sure that the room temperature is above 0°C.

Emergency emptying out

If the water is not discharged, proceed as follows to empty out the machine:

- Pull out the plug from the power socket;
- Close the water tap;
- If necessary, wait until the water has cooled down;
- Open the pump door;
- Place a bowl on the floor and place the end of the emergency emptying hose into the bowl. Remove its cap. The water should drain by gravity into the bowl. When the bowl is full, put the cap back on the hose. Empty the bowl. Repeat the procedure until water stops flowing out;
- Clean the pump if necessary as previously described;
- Replace the emergency emptying hose in its seat after having plugged it;
- Screw the pump cover again and close the door.

Something not working

Please carry out the following checks before contacting your local Service Force agent.

IMPORTANT: if you call out an engineer to a fault listed below, or to repair a fault caused by incorrect use or installation, a charge will be made even if the appliance is under guarantee.

During machine operation it is possible that the **red** Start/Pause pilot light flashes, one of the following alarm codes appears on the display and some acoustic signals sound to indicate that the machine is not working:

- **E10** : problem with the water supply
- **E20** : problem with water draining
- **E40** : door open

Once the problem has been eliminated, press the **“Start/Pause”** button to restart the programme. If after all checks, the problem persists, contact your local Service Force Centre.

Symptom	Solution
The machine does not start	<ul style="list-style-type: none"> ● The door has not been closed. (E40) ● The plug is not properly inserted in the power socket. ● There is no supply at the socket. ● The main fuse or the fuse in the plug has blown. ● The «Start/Pause» button has not been pressed. ● The «Delay start» option has been selected. ● The «Child lock» option has been enabled.
The machine does not fill	<ul style="list-style-type: none"> ● The water tap is closed. (E10) ● The filter in the inlet hose is blocked. (E10) ● The inlet hose may be squashed or kinked. (E10) ● The door has not been closed. (E40)
The machine fills then empties immediately	<ul style="list-style-type: none"> ● The end of the drain hose is too low. ● The end of the drain hose is submerged in water. ● There is no vent in the end of the drain hose.
The machine does not empty and/or does not spin	<ul style="list-style-type: none"> ● The drain hose may be squashed or kinked. (E20) ● The “Rinse Hold” or “Quiet” option has been selected. ● The drain pump may be blocked. (E20) ● The “No Spin” option has been selected ● The drainage system pipes are blocked. ● The programme “Soak”, which ends with water left in the tub, has been selected.
There is water on the floor	<ul style="list-style-type: none"> ● Too much detergent or unsuitable detergent has been used (creates too much foam). ● Check whether there are any leaks from the inlet hose fittings. It is not always easy to see this as the water runs down the hose; check to see if it is damp. ● The drain hose may be damaged or not securely positioned. ● The cap on the emergency emptying hose has not been replaced after cleaning the filter.
Unsatisfactory washing results	<ul style="list-style-type: none"> ● Too little detergent or unsuitable detergent has been used. An insufficient amount of detergent leaves the laundry looking grey and causes lime scale to form. ● Stubborn stains have not been treated prior to washing ● The correct wash programme/temperature has not been selected. ● Too much laundry has been placed in the drum.
The green Start/Pause light flashes and the display seems off	<ul style="list-style-type: none"> ● The energy save system is enabled. Press the Start/Pause button to switch the appliance on.

Symptom	Solution
The machine vibrates when spinning	<ul style="list-style-type: none"> • The internal packing has not been removed. • The machine is in contact with the wall or furniture. • The machine is not level and stable (check diagonally). • The washing load is badly distributed in the drum. • Maybe there is very little laundry in the drum.
The door will not open	<ul style="list-style-type: none"> • The water level is above the bottom edge of the door. • The machine is heating the water. • The drum is turning. <p>In any case the door can be opened only when the “Door lock” light has gone out.</p>
Spinning starts late or the machine does not spin	<ul style="list-style-type: none"> • The electronic balance control device has cut in because the laundry is not evenly distributed in the drum. The laundry is redistributed by reverse rotation of the drum. This may happen several times before the unbalance disappears and normal spinning can resume. If, after few minutes, the laundry is still not evenly distributed in the drum, the machine will not spin. In this case, redistribute the load manually and select the spin programme.
The machine makes an unusual noise	<ul style="list-style-type: none"> • The machine is fitted with a type of motor which makes an unusual noise compared with other traditional motors. This new motor ensures a softer start and more even distribution of the laundry in the drum when spinning, as well as increased stability of the machine.
No water is visible in the drum	<ul style="list-style-type: none"> • Machines based on modern technology operate very economically using very little water without affecting performance.

Repairs - After Sales Service

In the event of your appliance requiring service, or if you wish to purchase spare parts, please contact our extended warranty administrators by telephoning:

0870 01 07887

They will give you details for your local Service Force Centre.

Service Force are the appointed national appliance repair agents responsible for warranty repairs to this appliance. Before calling out an engineer, please ensure you have read the details under the heading “Something Not Working”.

When you contact the Service Force Centre you will need to give the following details:

1. Your name, address and post code
2. Your telephone number
3. Clear and concise details of fault
4. The purchase date and found on your receipt.
5. The model and serial number of the appliance (found on the rating plate - see picture)

So that you always have these numbers to hand, we recommend you to make a note of them here.

Model (Mod.).....

PNC (Prod. No.).....

SN (Ser. No.).....

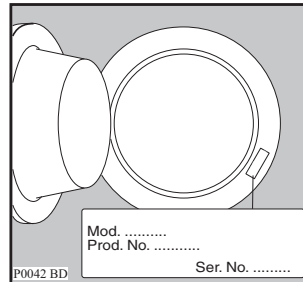

Your washing machine is covered by a 3 year parts and labour guarantee (see separate details given at point of sale). Please retain your purchase receipt safely for the service .

Spare parts

Always insist on genuine spare parts.

An authorised service engineer should service this product, and only genuine spare parts should be used. Under no circumstances should you attempt to repair the machine yourself. Repairs carried out by inexperienced persons may cause injury or serious malfunctioning. Contact your local John Lewis Branch.

John Lewis Partnership
171 Victoria Street
London SW1E 5NN
www.johnlewis.com

22/07

132 972 751

Free Manuals Download Website

<http://myh66.com>

<http://usermanuals.us>

<http://www.somanuals.com>

<http://www.4manuals.cc>

<http://www.manual-lib.com>

<http://www.404manual.com>

<http://www.luxmanual.com>

<http://aubethermostatmanual.com>

Golf course search by state

<http://golfingnear.com>

Email search by domain

<http://emailbydomain.com>

Auto manuals search

<http://auto.somanuals.com>

TV manuals search

<http://tv.somanuals.com>