

INSTALLATION MANUAL

R-410A OUTDOOR SPLIT-SYSTEM AIR CONDITIONING

MODELS: 16 SEER - CZF / AC6B / AL6B SERIES
2 TO 5 TONS



TABLE OF CONTENTS

GENERAL	1	SYSTEM CHARGE	11
SAFETY	1	INSTRUCTING THE OWNER	11
UNIT INSTALLATION	2	AC CONTROL BOARD FUNCTIONALITY	12
EVACUATION	5	WIRING DIAGRAM	16
ELECTRICAL CONNECTIONS	5		

LIST OF FIGURES

Typical Installation with Required Clearances	3	Communicating AC with Non-Communicating Air Handler or Furnace using Communicating Interface Control	7
Tubing Hanger	4	Thermostat Wiring – Single Stage Air Conditioner (with AC control) – PSC Air Handler	8
Underground Installation	4	Thermostat Wiring – Single Stage Air Conditioner (with AC control) – VS Air Handler	9
Heat Protection	5	Thermostat Wiring – Single Stage Air Conditioner (with AC control) – Modulating Furnace	10
Typical Field Wiring	6	Wiring Diagram (2 - 4 Ton)	16
Communications Harness Connection	6	Wiring Diagram (5 Ton)	17
CFM Selection Board	7		
Communicating AC with Communicating Air Handler or Furnace	7		

LIST OF TABLES

R-410A Saturation Properties	12	Status Code Display	13
TEST Input Functionality	13	Operational Fault Codes	14
Operational Mode Display	13	Sensor or Switch Fault Codes	14
Status Code Display	13	Wiring Related Fault Codes	14

SECTION I: GENERAL

The outdoor units are designed to be connected to a matching indoor coil with sweat connect lines. Sweat connect units are factory charged with refrigerant for the highest sales volume evaporator plus 15 feet of field supplied lines.

Matching indoor coils are available with a thermal expansion valve or an orifice liquid feed sized for the most common usage. The orifice size and/or refrigerant charge may need to be changed for some system combinations, elevation differences, or total line lengths. See tabular data sheet provided in unit literature packet for charge requirements. Refer to Application Data covering "General Piping Recommendations and Refrigerant Line Length" (Part Number 247077).

SECTION II: SAFETY



This is a safety alert symbol. When you see this symbol on labels or in manuals, be alert to the potential for personal injury.

Understand and pay particular attention to the signal words **DANGER**, **WARNING**, or **CAUTION**.

DANGER indicates an **imminently** hazardous situation, which, if not avoided, **will result in death or serious injury**.

WARNING indicates a **potentially** hazardous situation, which, if not avoided, **could result in death or serious injury**.

CAUTION indicates a potentially hazardous situation, which, if not avoided **may result in minor or moderate injury**. It is also used to alert against unsafe practices and hazards involving only property damage.

WARNING

Improper installation may create a condition where the operation of the product could cause personal injury or property damage. Improper installation, adjustment, alteration, service, or maintenance can cause injury or property damage. Refer to this manual for assistance or for additional information, consult a qualified contractor, installer, or service agency.

CAUTION

This product must be installed in strict compliance with the enclosed installation instructions and any applicable local, state, and national codes including, but not limited to building, electrical, and mechanical codes.

CAUTION

*R-410A systems operate at higher pressures than R-22 systems. Do not use R-22 service equipment or components on R-410A equipment. Service equipment **Must Be Rated** for R-410A.*

INSPECTION

As soon as a unit is received, it should be inspected for possible damage during transit. If damage is evident, the extent of the damage should be noted on the carrier's delivery receipt. A separate request for inspection by the carrier's agent should be made in writing. See Local Distributor for more information.

Requirements For Installing/Serviceing R-410A Equipment

- Gauge sets, hoses, refrigerant containers, and recovery systems must be designed to handle the POE type oils and the higher pressures of R-410A.
- Manifold sets should be 800 PSIG high side and 250 PSIG low side with 550 PSIG low side retard.
- All hoses must have a 700 PSIG service pressure rating.
- Leak detectors should be designed to detect HFC refrigerant.
- Recovery equipment (including refrigerant recovery containers) must be specifically designed to handle R-410A.
- Do not use an R-22 TXV.
- A liquid-line filter drier is required on every unit.

LIMITATIONS

The unit should be installed in accordance with all National, State, and Local Safety Codes and the limitations listed below:

1. Limitations for the indoor unit, coil, and appropriate accessories must also be observed.
2. Only variable speed air handlers or variable speed furnaces should be used with these models.
3. The outdoor unit must not be installed with any duct work in the air stream. The outdoor fan is the propeller type and is not designed to operate against any additional external static pressure.
4. The maximum and minimum conditions for operation must be observed to ensure a system that will give maximum performance with minimum service.

5. The unit should not be operated at outdoor temperatures below 65° F without an approved low ambient operation accessory kit installed.
6. The maximum allowable line length for this product is 75 feet.

SECTION III: UNIT INSTALLATION**LOCATION**

Before starting the installation, select and check the suitability of the location for both the indoor and outdoor unit. Observe all limitations and clearance requirements.

The outdoor unit must have sufficient clearance for air entrance to the condenser coil, for air discharge, and for service access. See Figure 1 "Typical Installation with Required Clearances".

NOTICE

For multiple unit installations, units must be spaced a minimum of 24 inches apart (coil face to coil face).

If the unit is to be installed on a hot sun exposed roof or a black-topped ground area, the unit should be raised sufficiently above the roof or ground to avoid taking the accumulated layer of hot air into the outdoor unit.

Provide an adequate structural support.

ADD-ON REPLACEMENT/RETROFIT

When this unit is being used as a replacement for an R-22 unit, it is required that the outdoor unit, indoor coil, and metering device all be replaced. Line-set change out is also recommended. The following steps should be performed in order to insure proper system operation and performance.

1. Change-out of the indoor coil to an approved R-410A coil with the appropriate metering device.
2. Change-out of the line-set when replacing an R-22 unit with an R-410A unit is highly recommended to reduce cross-contamination of oils and refrigerants.
3. If change-out of the line set is not practical, then the following precautions should be taken.
 - Inspect the line set for kinks, sharp bends, or other restrictions, and for corrosion.
 - Determine if there are any low spots which might be serving as oil traps.
 - Flush the line set with a commercially available flush kit to remove as much of the existing oil and contaminants as possible.
 - Install a suction line filter-drier to trap any remaining contaminants, and remove after 50 hours of operation.
4. If the outdoor unit is being replaced due to a compressor burnout, then installation of a 100% activated alumina suction-line filter drier is required, in addition to the factory installed liquid-line drier. Operate the system for 10 hours. Monitor the suction drier pressure drop. If the pressure drop exceeds 3 psig, replace both the suction-line and liquid-line driers. After a total of 10 hours run time where the suction-line pressure drop has not exceeded 3 psig, replace the liquid line drier, and remove the suction-line drier. Never leave a suction-line drier in the system longer than 50 hours of run time.

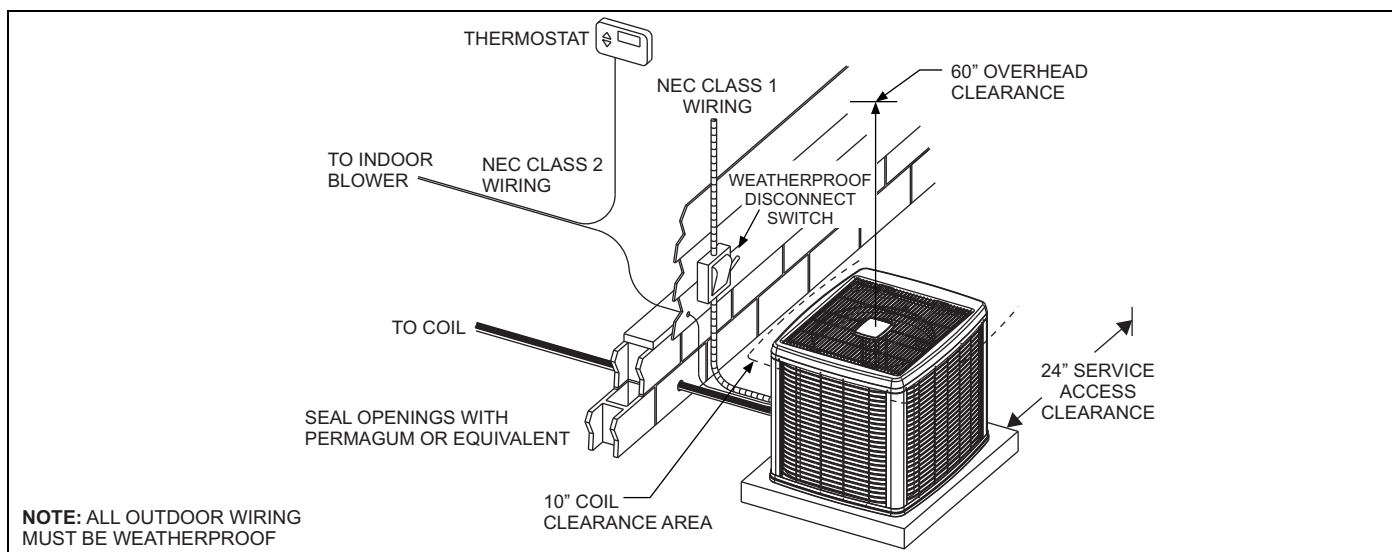

FIGURE 1: Typical Installation with Required Clearances

GROUND INSTALLATION

The unit may be installed at ground level on a solid base that will not shift or settle, causing strain on the refrigerant lines and possible leaks. Maintain the clearances shown in Figure 1 "Typical Installation with Required Clearances" and install the unit in a level position.

Normal operating sound levels may be objectionable if the unit is placed directly under windows of certain rooms (bedrooms, study, etc.).

Isolate the unit from rain gutters to avoid any possible wash out of the foundation.

ROOF INSTALLATION

When installing units on a roof, the structure must be capable of supporting the total weight of the unit, including a pad, lintel, rails, etc., which should be used to minimize the transmission of sound or vibration into the conditioned space.

UNIT PLACEMENT

1. Provide a base in the pre-determined location.
2. Remove the shipping carton and inspect for possible damage.
3. Compressor tie-down bolts should remain tightened.
4. Position the unit on the base provided.

LIQUID LINE FILTER-DRIER

The air conditioning unit's copper spun filter/dryer is located on the liquid line.

NOTICE

Replacements for the liquid line drier must be exactly the same as marked on the original factory drier. See Source 1 for O.E.M. replacement driers.

CAUTION

Failure to do so or using a substitute drier or a granular type may result in damage to the equipment.

Filter-Drier Source 1 Part No.	Apply with Models
029-22195-000	All

TXV INSTALLATIONS

The following are the basic steps for installation. For detailed instructions, refer to the Installation Instructions accompanying the TXV kit.

Install TXV kit as follows:

1. Relieve the holding charge from the indoor coil by depressing the Schrader valve stem located in the end of the suction line. Cut the spundown copper to allow installation of the suction line.
2. After holding charge is completely discharged, loosen and remove the schrader cap seal.
3. Loosen and remove distributor cap seal.
4. Install the thermal expansion valve to the orifice distributor assembly with supplied fittings. Hand tighten and turn an additional 1/4 turn to seal. Do not overtighten fittings.
5. Install the liquid line to the top of the thermal expansion valve with fitting supplied with the liquid line. Hand modify the liquid line to align with casing opening. Hand tighten the liquid line and an additional 1/4 turn to seal.
6. Install the TXV equalizer line into the vapor line as follows:
 - a. Hand tighten the 1/4" SAE nut to the schrader fitting and an additional 1/3 turn to seal.
7. At this time do not attach sensing bulb. This will be covered later after brazing of the lines.

PIPING CONNECTIONS

CAUTION

This system uses R-410A refrigerant which operates at higher pressures than R-22. No other refrigerant may be used in this system. Gauge sets, hoses, refrigerant containers, and recovery systems must be designed to handle R-410A. If you are unsure, consult the equipment manufacturer.

WARNING

Never install a suction-line filter drier in the liquid line of an R-410A system. Failure to follow this warning can cause a fire, injury or death.

The outdoor condensing unit must be connected to the indoor evaporator coil using field supplied refrigerant grade copper tubing that is internally clean and dry. Units should be installed only with the tubing sizes for approved system combinations as specified in tabular data sheet. The charge given is applicable for total tubing lengths up to 15 feet. See Application Data Part Number 247077 for installing tubing of longer lengths and elevation differences.

NOTICE

Using a larger than specified line size could result in oil return problems. Using too small a line will result in loss of capacity and other problems caused by insufficient refrigerant flow. Slope horizontal vapor lines at least 1" every 20 feet toward the outdoor unit to facilitate proper oil return.

PRECAUTIONS DURING LINE INSTALLATION

1. Install the lines with as few bends as possible. Care must be taken not to damage the couplings or kink the tubing. Use clean hard drawn copper tubing where no appreciable amount of bending around obstruction is necessary. If soft copper must be used, care must be taken to avoid sharp bends which may cause a restriction.
2. The lines should be installed so that they will not obstruct service access to the coil, air handling system, or filter.
3. Care must also be taken to isolate the refrigerant lines to minimize noise transmission from the equipment to the structure.
4. The vapor line must be insulated with a minimum of 1/2" foam rubber insulation (Armaflex or equivalent). Liquid lines that will be exposed to direct sunlight and/or high temperatures must also be insulated.
5. Tape and suspend the refrigerant lines as shown. DO NOT allow tube metal-to-metal contact. See Figure 2 "Tubing Hanger".
6. Use PVC piping as a conduit for all underground installations as shown in Figure 3 "Underground Installation". Buried lines should be kept as short as possible to minimize the build up of liquid refrigerant in the vapor line during long periods of shutdown.
7. Pack fiberglass insulation and a sealing material such as permagum around refrigerant lines where they penetrate a wall to reduce vibration and to retain some flexibility.
8. See application part number 247077 for additional piping information.

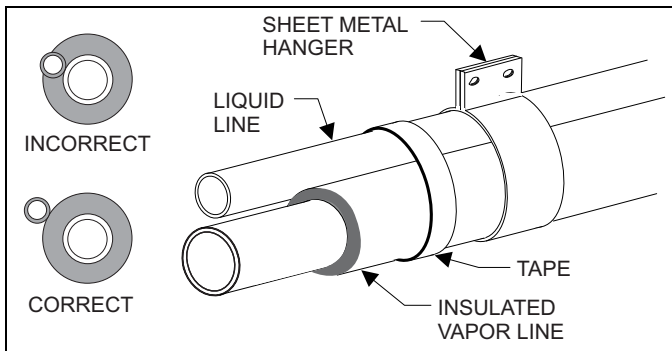

FIGURE 2: Tubing Hanger

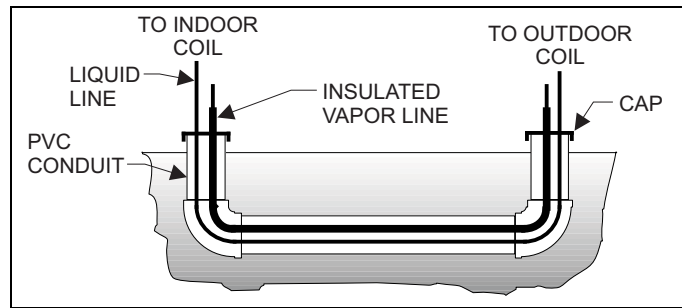

FIGURE 3: Underground Installation

PRECAUTIONS DURING BRAZING OF LINES

All outdoor unit and evaporator coil connections are copper-to-copper and should be brazed with a phosphorous-copper alloy material such as Silfos-5 or equivalent. DO NOT use soft solder. The outdoor units have reusable service valves on both the liquid and vapor connections. The total system refrigerant charge is retained within the outdoor unit during shipping and installation. The reusable service valves are provided to evacuate and charge per this instruction.

Serious service problems can be avoided by taking adequate precautions to ensure an internally clean and dry system.

CAUTION

Dry nitrogen should always be supplied through the tubing while it is being brazed, because the temperature is high enough to cause oxidation of the copper unless an inert atmosphere is provided. The flow of dry nitrogen should continue until the joint has cooled. Always use a pressure regulator and safety valve to insure that only low pressure dry nitrogen is introduced into the tubing. Only a small flow is necessary to displace air and prevent oxidation.

PRECAUTIONS DURING BRAZING SERVICE VALVE

Precautions should be taken to prevent heat damage to service valves by wrapping a wet rag around it as shown in Figure 4 "Heat Protection". Also, protect all painted surfaces, insulation, and plastic base during brazing. After brazing, cool joint with wet rag.

WARNING

This is not a backseating valve. The service access port has a valve core. Opening or closing valve does not close service access port.

If the valve stem is backed out past the chamfered retaining wall, the O-ring can be damaged causing leakage or system pressure could force the valve stem out of the valve body possibly causing personal injury.

The valve can be opened by removing the plunger cap and fully inserting a hex wrench into the stem and backing out counter-clockwise until valve stem just touches the chamfered retaining wall.

Connect the refrigerant lines using the following procedure:

1. Refer to the Tabular Data Sheet for proper vapor and liquid line sizing.

CAUTION

Do not leave the system open to the atmosphere. Unit damage could occur due to moisture being absorbed by the POE oil in the system. This type of oil is highly susceptible to moisture absorption.

2. Remove the cap and Schrader core from both the liquid and vapor service valve service ports at the outdoor unit. Connect low pressure nitrogen to the liquid line service port.
3. Braze the liquid line to the liquid valve at the outdoor unit. Be sure to wrap the valve body with a wet rag. Allow the nitrogen to continue flowing.
4. Relieve the holding charge from the indoor coil by depressing the Schrader valve stem located in the end of the suction line. Cut the spundown copper to allow installation of the suction line.

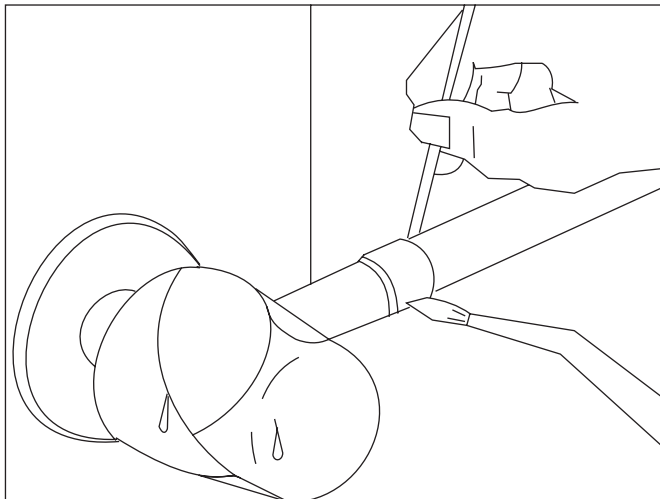

FIGURE 4: Heat Protection

CAUTION

The evaporator is pressurized.

5. If TXV has not been installed refer to Page 3 "TXV INSTALLATIONS".
6. Braze the liquid line to the evaporator liquid connection. Nitrogen should be flowing through the evaporator coil.
7. Slide the grommet away from the vapor connection at the indoor coil. Braze the vapor line to the evaporator vapor connection. After the connection has cooled, slide the grommet back into original position.
 - a. Install the TXV bulb to the vapor line near the equalizer line, using the bulb clamp(s) furnished with the TXV assembly. Ensure the bulb is making maximum contact. For detailed instructions, refer to the Installation Instructions accompanying the TXV kit.
 - b. Bulb should be installed on a horizontal run of the vapor line if possible. The bulb should be installed on top of the line.
 - c. If bulb installation is made on a vertical run, the bulb should be located at least 16 inches from any bend, and on the tubing sides opposite the plane of the bend. The bulb should be positioned with the bulb tail at the top, so that the bulb acts as a reservoir.
 - d. Bulb should be insulated using thermal insulation provided to protect it from the effect of the surrounding ambient temperature. Cover completely to insulate from air-stream.

CAUTION

In all cases, mount the TXV bulb after vapor line is brazed and has had sufficient time to cool.

8. Protect the vapor valve with a wet rag and braze the vapor line connection to the outdoor unit. The nitrogen flow should be exiting the system from the vapor service port connection. After this connection has cooled, remove the nitrogen source from the liquid fitting service port.
9. Replace the Schrader core in the liquid and vapor valves.
10. Leak test all refrigerant piping connections.

NOTICE

Line set and indoor coil can be pressurized to 250 psig with dry nitrogen and leak tested with a bubble type leak detector. Then release the nitrogen charge.

NOTICE

Do not use the system refrigerant in the outdoor unit to purge or leak test.

WARNING

Never attempt to repair any brazed connections while the system is under pressure. Personal injury could result.

SECTION IV: EVACUATION

1. It will be necessary to evacuate the system to 500 microns or less. If a leak is suspected, leak test with dry nitrogen to locate the leak. Repair the leak and test again.

To verify that the system has no leaks, simply close the valve to the vacuum pump suction to isolate the pump and hold the system under vacuum. Watch the micron gauge for a few minutes. If the micron gauge indicates a steady and continuous rise, it's an indication of a leak. If the gauge shows a rise, then levels off after a few minutes and remains fairly constant, it's an indication that the system is leak free but still contains moisture and may require further evacuation if the reading is above 500 microns.

2. While system is being evacuated proceed to SECTION V "ELECTRICAL CONNECTIONS". System charging will be covered under SECTION VI "SYSTEM CHARGE"

SECTION V: ELECTRICAL CONNECTIONS

GENERAL INFORMATION & GROUNDING

Check the electrical supply to be sure that it meets the values specified on the unit nameplate and wiring label.

Power wiring, control (low voltage) wiring, disconnect switches, and over current protection must be supplied by the installer. Wire size should be sized per NEC requirements.

CAUTION

All field wiring must USE COPPER CONDUCTORS ONLY and be in accordance with Local, National, Fire, Safety, & Electrical Codes. This unit must be grounded with a separate ground wire in accordance with the above codes.

The complete connection diagram and schematic wiring label is located on the inside surface of the unit service access panel.

FIELD CONNECTIONS POWER WIRING

1. Install the proper size weatherproof disconnect switch outdoors and within sight of the unit.
2. Remove the screws at the bottom of the corner cover. Slide corner cover down and remove from unit. See Figure 5 "Typical Field Wiring".
3. Run power wiring from the disconnect switch to the unit.
4. Remove the service access panel to gain access to the unit wiring. Route wires from disconnect through power wiring opening provided and into the unit control box.
5. Install the proper size time-delay fuses or circuit breaker, and make the power supply connections.

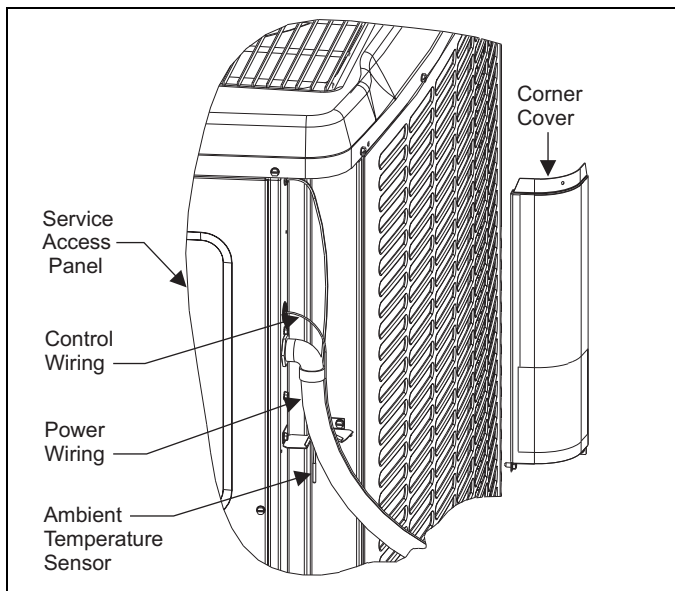

FIGURE 5: Typical Field Wiring

FIELD CONNECTIONS CONTROL WIRING (CONVENTIONAL)

1. Route low voltage wiring into bottom of control box. Make low voltage wiring connections inside the junction box per Figures 10-12 "Thermostat Wiring".
2. The complete connection diagram and schematic wiring label is located on the inside surface of the unit service access panel.
3. Replace the corner cover and service access panel that were removed in Steps 2 and 4 of the "FIELD CONNECTIONS POWER WIRING" section.

NOTICE

Ambient temperature sensor should extend below corner cover by 1".

4. All field wiring to be in accordance with national electrical codes (NEC) and/or local-city codes.
5. Mount the thermostat about 5 ft. above the floor, where it will be exposed to normal room air circulation. Do not place it on an outside wall or where it is exposed to the radiant effect from exposed glass or appliances, drafts from outside doors, or supply air grilles.
6. Route the 24-volt control wiring (NEC Class 2) from the outdoor unit to the indoor unit and thermostat.

NOTICE

Ambient temperature sensor should extend below corner cover by 1".

6. Mount the thermostat about 5 ft. above the floor, where it will be exposed to normal room air circulation. Do not place it on an outside wall or where it is exposed to the radiant effect from exposed glass or appliances, drafts from outside doors, or supply air grilles.
7. Route the 24-volt control wiring (NEC Class 2) from the outdoor unit to the indoor unit and thermostat.

NOTICE

To eliminate erratic operation, seal the hole in the wall at the thermostat with Pergamum or equivalent to prevent air drafts affecting the operation of the thermostat.

NOTICE

To eliminate erratic operation, seal the hole in the wall at the thermostat with Pergamum or equivalent to prevent air drafts affecting the operation of the thermostat.

FIELD CONNECTIONS CONTROL WIRING (SERIAL COMMUNICATION)

1. The Communications Harness is provided with the Touch Screen Communicating Control.
2. Route low voltage four conductor shielded thermostat communications harness into junction box and connect to communications port on control board. See Figure 6 "Communications Harness Connection".
3. Route low voltage wiring into bottom of control box. Make low voltage wiring connections inside the junction box per Figures 8-9.
4. The complete connection diagram and schematic wiring label is located on the inside surface of the unit service access panel.

IMPORTANT

If unit is going to be setup as a communicating system, the conventional wiring must be removed from the Outdoor Control Board, if not, damage to control board or indoor control could occur.

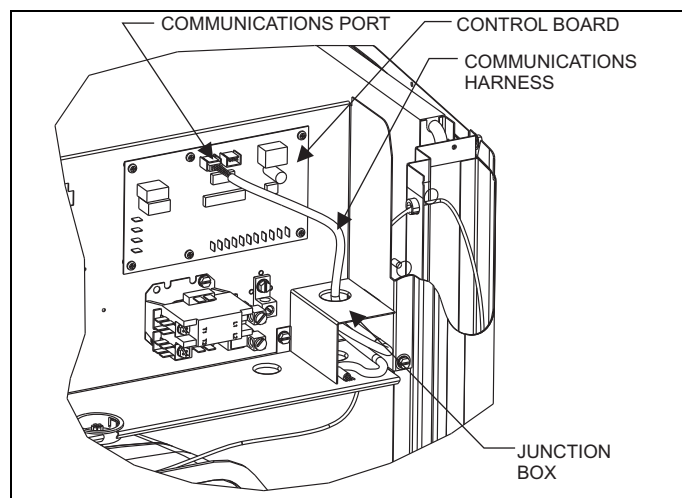

FIGURE 6: Communications Harness Connection

5. Replace the corner cover and service access panel that were removed in Steps 2 and 4 of the "Field Connections Power Wiring" section.

NOTICE

Ambient temperature sensor should extend below corner cover by 1".

NOTICE

To eliminate erratic operation, seal the hole in the wall at the thermostat with Pergamum or equivalent to prevent air drafts affecting the operation of the thermostat.

CFM SELECTION BOARD SETTINGS

For proper system operation the CFM Selection Board jumpers must be set properly.

Refer to the Tech Guide for the recommended air flow settings for each size condensing unit and matchup.

Set the cooling speed per the instructions for the air handler or furnace by selecting the correct COOL and ADJ taps. Verify the airflow using the LED display on the CFM selection board.

The HUMIDISTAT jumper must also be removed if a dehumidistat is installed.

If installed as a communicating system (outdoor, indoor and thermostat), the system will automatically adjust to the optimal airflow settings. These parameters can also be modified using the Touch Screen Communicating Control. Refer to the Touch Screen Communicating Control owner's manual for this procedure. Manual setting of the airflow jumpers on the ID equipment is not necessary with the Touch Screen Communicating Control.

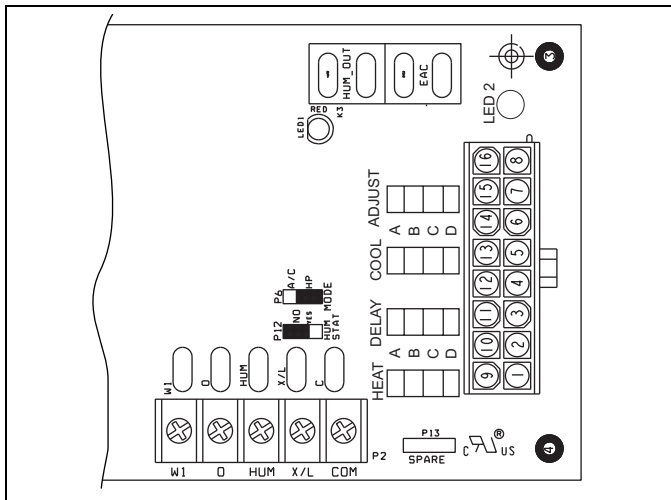

FIGURE 7: CFM Selection Board

DEHUMIDIFICATION CONTROL

A dehumidification control accessory 2HU06700124 may be used with variable speed air handlers or furnaces in high humidity areas. This control works with the variable speed indoor unit to provide cooling at a reduced air flow, lowering evaporator temperature and increasing latent capacity. The humidistat in this control opens the humidistat contacts on humidity rise. To install, refer to instructions packaged with the accessory and Figures 7-9. Prior to the installation of the dehumidification control, the jumper across the HUMIDISTAT terminals on the indoor variable speed air handler or furnace CFM selection board must be removed.

During cooling, if the relative humidity in the space is higher than the desired set point of the dehumidification control, the variable speed blower motor will operate at lower speed until the dehumidification control is satisfied. A 40-60% relative humidity level is recommended to achieve optimum comfort.

If a dehumidification control is installed, it is recommended that a minimum air flow of 325 cfm/ton be supplied at all times.

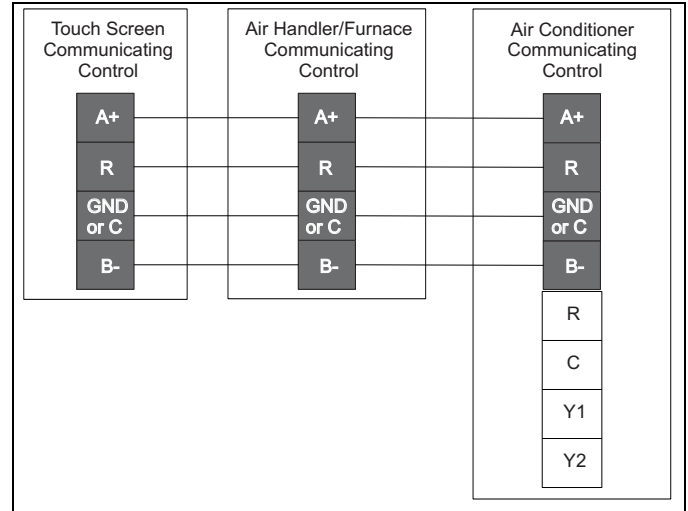

FIGURE 8: Communicating AC with Communicating Air Handler or Furnace

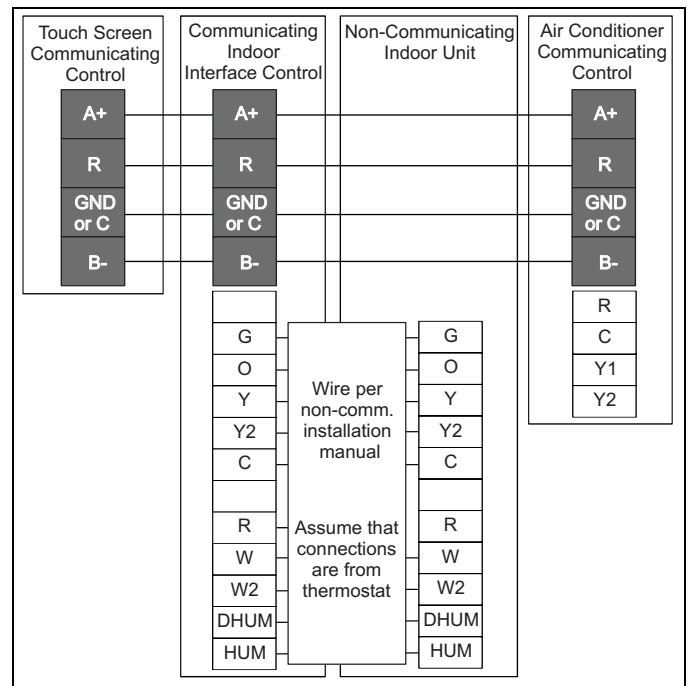

FIGURE 9: Communicating AC with Non-Communicating Air Handler or Furnace using Communicating Interface Control

For additional connection diagrams for all UPG equipment refer to "Low Voltage System Wiring" document available online at www.upgnet.com in the Product Catalog Section.

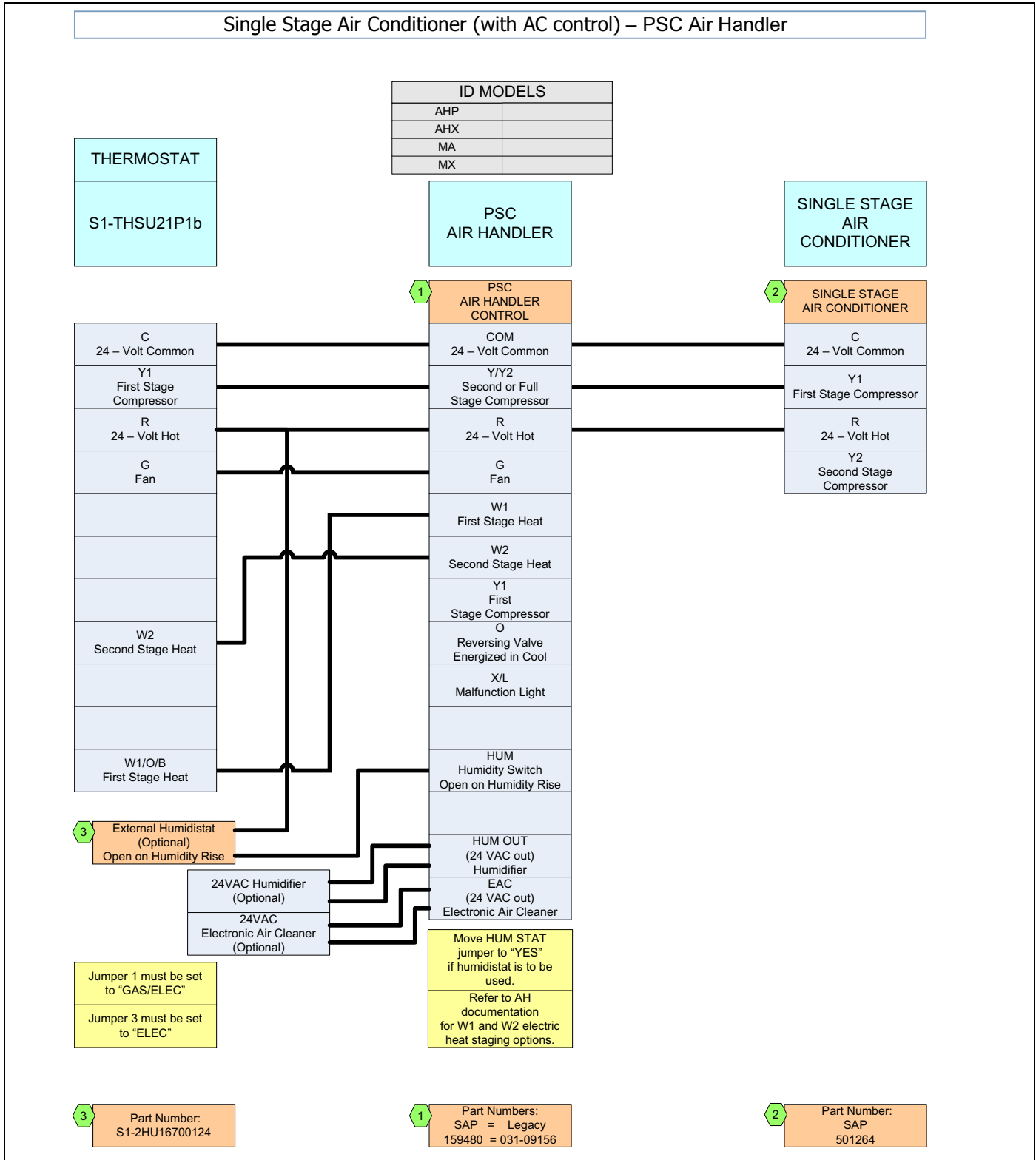

FIGURE 10: Thermostat Wiring – Single Stage Air Conditioner (with AC control) – PSC Air Handler

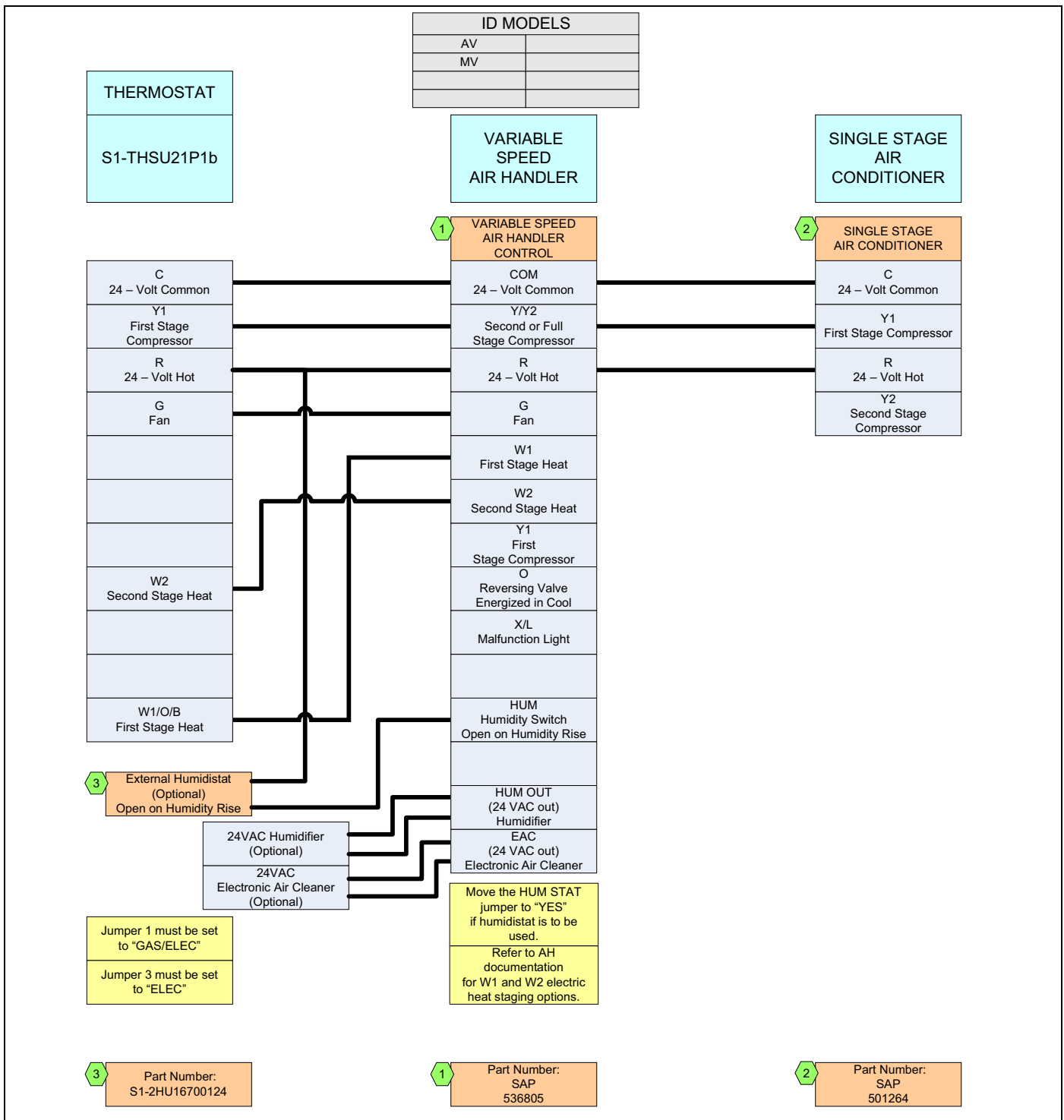

FIGURE 11: Thermostat Wiring – Single Stage Air Conditioner (with AC control) – VS Air Handler

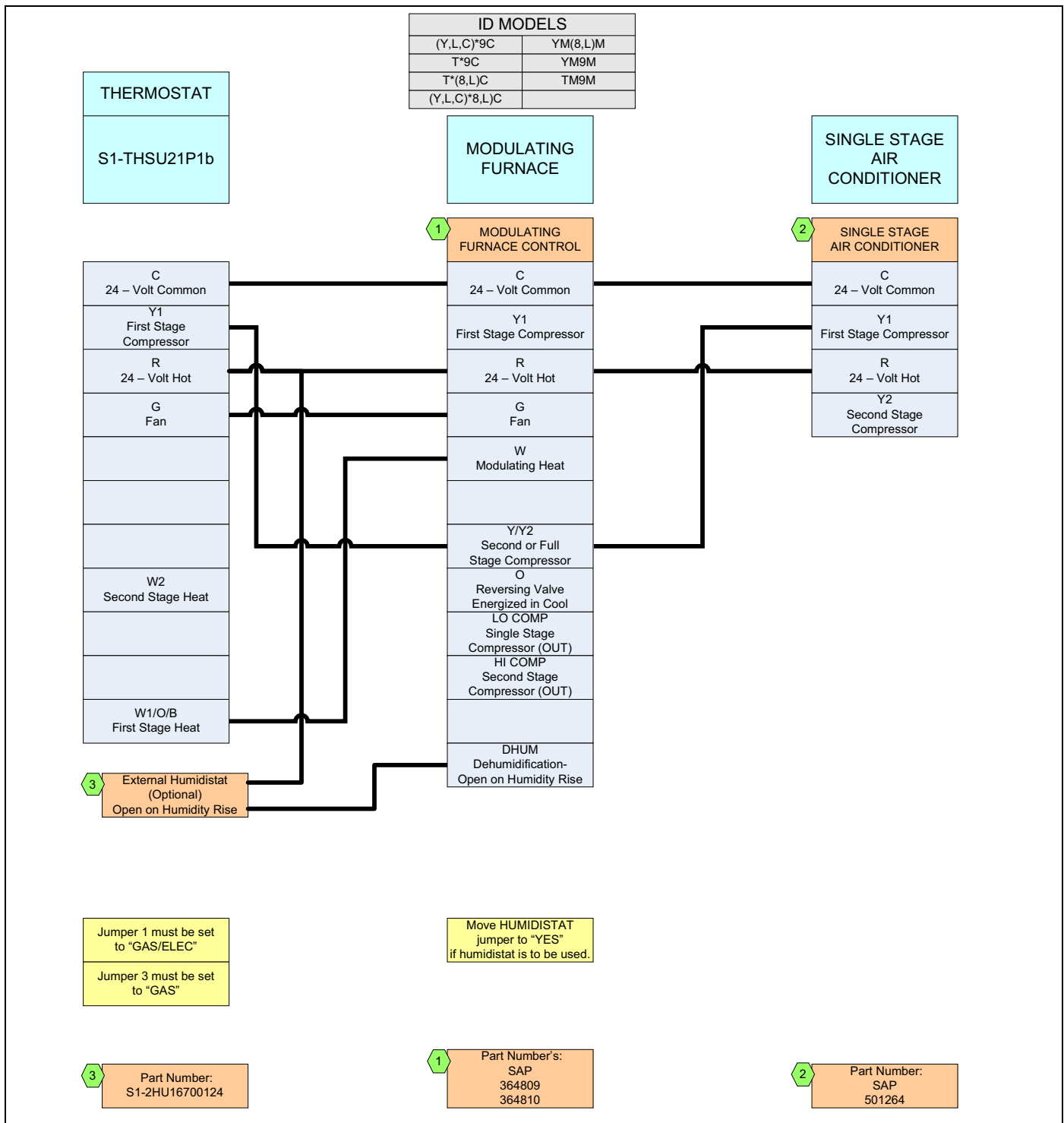

FIGURE 12: Thermostat Wiring – Single Stage Air Conditioner (with AC control) – Modulating Furnace

SECTION VI: SYSTEM CHARGE

CAUTION

Refrigerant charging should only be carried out by a qualified air conditioning contractor.

CAUTION

R-410A refrigerant cylinders are rose colored, and have a dip tube which allows liquid to flow out of the cylinder in the **Upright Position**. Always charge the system slowly with the tank in the upright position.

WARNING

DO NOT attempt to pump "Total System Charge" into outdoor unit for maintenance, service, etc. This may cause damage to the compressor and/or other components. The outdoor unit only has enough volume for the factory charge, not the "Total System Charge".

1. The factory charge in the outdoor unit includes enough charge for the unit, a 15 ft. line set and the smallest rated indoor coil match-up. Some indoor coil matches may require additional charge. See tabular data sheet provided in unit literature packet for charge requirements.
2. Once line size/length and indoor coil adders have been figured, weigh in this amount of charge by adding it through the liquid service port while the indoor side of the system is still under a vacuum. The vacuum that is on the indoor side of the system will allow you to add most of the charge adder. If you are not able to add the full amount then add the remainder after starting up the system to verify proper subcooling. The subcooling charging method is explained further in this section.
3. Release the refrigerant charge from the outdoor unit into the system. Open both the liquid and vapor service valves at outdoor unit by removing the plunger cap and with an allen wrench back out counter-clockwise until valve stem just touches the chamfered retaining wall. "PRECAUTIONS DURING BRAZING SERVICE VALVE".
4. Replace plunger cap finger tight, then tighten an additional 1/12 turn (1/2 hex flat). Cap must be replaced to prevent leaks.
5. Use the following subcooling charging method whenever additional refrigerant is required for the system charge. A superheat charging method is not suitable for TXV equipped systems.

Measurement Method

If a calibrated charging cylinder or accurate weighing device is available, add refrigerant accordingly.

CAUTION

Compressor damage will occur if system is improperly charged. On new system installations, charge system per tabular data sheet for the matched coil and follow guidelines in this instruction.

Subcooling Charging Method

This condensing unit must only be used with the matching thermostatic expansion valve kit listed in the Tabular Data Sheet. This unit **must** be charged during **cooling operation (Y1)** operation only. Charging should be matched per the subcooling chart located on the rating plate.

1. Set the system running in the **cooling (Y1)** cooling mode by setting the thermostat at least 6°F below the room temperature.
2. Operate the system for a minimum of 15-20 minutes.
3. Refer to the Tech Guide for the recommended airflow and verify this indoor airflow (it should be about 400 SCFM per ton).
4. Measure the liquid refrigerant pressure P and temperature T at the service valve.
5. Calculate the saturated liquid temperature ST from Table 1 "R-410A Saturation Properties".
6. Subcooling temperature TC = Saturated Temperature (ST) - Liquid Temp (T).

Example: The pressure P and temperature T measured at the liquid service port is 360 Psig and 93°F. From Table 1, the saturated temperature for 360 Psig is 109°. The subcooling temperature TC = $109^{\circ} - 93^{\circ} = 16^{\circ}\text{F}$

Add charge if the calculated subcooling temperature TC in Step 6 is lower than the recommended level. Remove and recover the refrigerant if the subcooling TC is higher than the recommended level. See Table 1 for R-410A saturation temperatures.

After disconnecting manifold gauge set check flare caps on service ports to be sure they are leak tight. DO NOT OVERTIGHTEN (between 40 and 60 inch - lbs. maximum).

The "Total System Charge" must be permanently stamped on the unit data plate.

Total system charge is determined as follows:

1. Determine outdoor unit charge from tabular data sheet.
2. Determine indoor coil adjustment from tabular data sheet.
3. Calculate the line charge using the tabular data sheet if line length is greater than 15 feet.
4. Total system charge = item 1 + item 2 + item 3.
5. Permanently stamp the unit data plate with the total amount of refrigerant in the system.

SECTION VII: INSTRUCTING THE OWNER

Assist owner with processing warranty cards and/or online registration. Review Owners Manual, provide a copy to the owner, and provide guidance on proper operation and maintenance. Instruct the owner or the operator how to start, stop, and adjust temperature setting.

The installer should also instruct the owner on proper operation and maintenance of all other system components.

MAINTENANCE

1. Dirt should not be allowed to accumulate on the outdoor coils or other parts in the air circuit. Clean as often as necessary to keep the unit clean. Use a brush, vacuum cleaner attachment, or other suitable means.
2. The outdoor fan motor is permanently lubricated and does not require periodic oiling.

NOTICE

On 5 Ton unit the outdoor fan motor is a permanent magnet DC brushless type. The motor requires a separate Electronic Control to operate. Do not attempt to replace this motor with a typical PSC type. Damage to Electronic Control may result.

3. If the coil needs to be cleaned, use clean water to wash dust, dirt, and debris from outdoor condensing coil.

NOTICE

DO NOT use coil cleaners to clean outdoor condensing coil. Cleaners containing HF-, hydroxides, chlorides, and sulfates can greatly reduce the lifetime of the aluminum condensing coil.

4. Refer to the furnace or air handler instructions for filter and blower motor maintenance.

5. The indoor coil and drain pan should be inspected and cleaned regularly to prevent odors and assure proper drainage.

CAUTION

Do not connect manifold gauges unless trouble is suspected. Approximately 3/4 ounce of refrigerant will be lost each time a standard manifold gauge is connected.

CAUTION

IT IS UNLAWFUL TO KNOWINGLY VENT, RELEASE OR DISCHARGE REFRIGERANT INTO THE OPEN AIR DURING REPAIR, SERVICE, MAINTENANCE OR THE FINAL DISPOSAL OF THIS UNIT.

WHEN THE SYSTEM IS FUNCTIONING PROPERLY AND THE OWNER HAS BEEN FULLY INSTRUCTED, SECURE THE OWNER'S APPROVAL.

TABLE 1: R-410A Saturation Properties

TEMP. °F	PRESSURE PSIG	TEMP. °F	PRESSURE PSIG	TEMP. °F	PRESSURE PSIG	TEMP. °F	PRESSURE PSIG	TEMP. °F	PRESSURE PSIG
45	129.70	60	169.60	75	217.40	90	274.10	105	340.50
46	132.20	61	172.60	76	220.90	91	278.20	106	345.30
47	134.60	62	175.50	77	224.40	92	282.30	107	350.10
48	137.10	63	178.50	78	228.00	93	286.50	108	355.00
49	139.60	64	181.60	79	231.60	94	290.80	109	360.00
50	142.20	65	184.60	80	235.30	95	295.10	110	365.00
51	144.80	66	187.70	81	239.00	96	299.40	111	370.00
52	147.40	67	190.90	82	242.70	97	303.80	112	375.10
53	150.10	68	194.10	83	246.50	98	308.20	113	380.20
54	152.80	69	197.30	84	250.30	99	312.70	114	385.40
55	155.50	70	200.60	85	254.10	100	317.20	115	390.70
56	158.20	71	203.90	86	258.00	101	321.80	116	396.00
57	161.00	72	207.20	87	262.00	102	326.40	117	401.30
58	163.90	73	210.60	88	266.00	103	331.00	118	406.70
59	166.70	74	214.00	89	270.00	104	335.70	119	412.20

SECTION VIII: AC CONTROL BOARD FUNCTIONALITY

ANIT-SHORT CYCLE DELAY

The control includes a five-minute anti-short cycle delay (ASCD) timer to prevent the compressor from short cycling after a power interruption or thermostat signal interruption. The ASCD timer is applied when the control is first powered from the indoor unit thermostat and immediately following the completion of a compressor run cycle. The compressor and the outdoor fan will not operate during the five minutes that the timer is active.

The ASCD timer can be bypassed by connecting the TEST terminals for three seconds while the thermostat is calling for compressor operation (Y1 input signal energized).

LOW VOLTAGE DETECTION

The control monitors the transformer secondary (24 VAC) voltage and provides low voltage protection for the AC unit and its components. In particular, the control prevents contactor chatter during low voltage conditions. If the voltage drops below approximately 19 VAC, the control will continue to energize any relays that are already energized but will not energize any additional relays until the voltage level increases. If the voltage drops below approximately 16 VAC, the control will immediately de-energize the relay outputs and will not energize any relays until the voltage level increases. The control will store and display the appropriate fault codes when low voltage conditions occur.

TEST INPUT

The control includes a TEST input connector that can be used for various testing functions during installation and service. Table 2 summarizes the behavior of the control when the two TEST pins are connected.

TABLE 2: TEST Input Functionality

Duration of connection (seconds)	Control Behavior with no system master signals present	Control behavior with system master signals present
< 2	No response	No response
2 <	Display compressor type TS, Ultratech, or single stage compressor, Ignore LPS	Bypass ASCD (Reduce timer to zero immediately). If Y1 (thermostat or communication) is present and the high-pressure switch is closed, contactors will be energized.
	Clear soft lockout	Clear soft lockout
	Clear hard lockout	Clear hard lockout
	Reset TS anticipation mode counter to zero for TS systems.	Reset TS anticipation mode counter to zero for TS systems.
		Reduce TS staging delays for TS systems as described below.
Connection removed	Resume normal LED display	
Connection not removed	Nothing more than previously explained	

LED DIAGNOSTIC INDICATORS

The control includes two LED's that display diagnostic information. LED1 is red and LED2 is green. These LED's are used to display operational mode, fault information. A third LED, LED3 is used to display status information. LED3 is yellow. These LED's are used to display operational mode, status, and fault information.

OPERATIONAL MODE DETECTION

The control can be used in a variety of applications including AC units with multistage compressors. The control uses various inputs to determine the proper mode of operation.

The control senses the connections that are made to M, M1, and M2 terminals and determines the correct operational mode for the control. This is done each time power to the control is cycled. Therefore, it is important that no loads be attached to the M1 or M2 terminals of the control for single-stage compressors, and no loads be attached to the M1 terminal of the control for a scroll two-stage compressor.

IMPORTANT

Do not connect any loads to the M1 or M2 terminals of the control for single-stage compressors, and no loads should be attached to the M1 terminal of the control for scroll two-stage compressor. Incorrect system behavior could result.

OPERATIONAL MODE DISPLAY

The control will display its active operational mode using the onboard LED's when the TEST pins are connected while no thermostat signals are energized. Table 3 "Operational Mode Display" describes the operational modes. The control will display the operational mode as long as the TEST pins are shorted and no thermostat signals are energized. When the TEST pin short is removed, the control will return to normal LED displays.

TABLE 3: Operational Mode Display

Compressor Type	LED1 (Red)	LED2 (Green)
Single Stage Compressor	1 flash	---
TS Compressor	2 flashes	---
UltraTech Compressor	3 flashes	---

STATUS CODE DISPLAY

The control also provides status codes using the LED's. Status codes indicate the state of the operation of the unit but do not represent a fault. Tables 4 & 5 describes the LED displays during status codes. Status codes will not be displayed when a fault code is present.

TABLE 4: Status Code Display

Description	Required Condition	LED1 (Red)	LED2 (Green)
No power to control	No power to control	OFF	OFF
First-stage compressor operation – TS or UltraTech	TS – M & M1 energized, UltraTech – M energized, Single Stage - NA	OFF	ON
Second-stage compressor operation - TS, UltraTech, or Single Stage	TS and UltraTech – M & M2 energized, Single Stage – M energized	ON	ON
Control normal operation – no communication or call for compressor present	No faults active, Y1 or Y2 not present	OFF	2s ON / 2s OFF
Control normal operation – in ASCD period	No faults active, Y1 or Y2 present, ASCD timer not expired	OFF	0.1 sec ON / 0.1 sec OFF

TABLE 5: Status Code Display

Description	Required Condition	LED3 (Yellow)
Control normal operation – with active communication present	System is active and presently communicating successfully.	0.1 sec ON / 0.1 sec OFF
Control powered – without active communication present	System has 24 VAC present and the microprocessor is active.	2s ON / 2s OFF

FAULT CODE DISPLAY

The control will display any fault code that is currently active using the LED's. The control will display the fault code, pause two seconds, and display the fault again. The control will continue the fault code display until the condition that caused the fault code no longer exists. If multiple fault codes are present at the same time, the control will display only the most recent fault.

Table 6 describes the operational faults that the control can detect. The control displays these types of errors by flashing the LED1 (Red) and/or LED2 (Green).

TABLE 6: Operational Fault Codes

Description	LED1 Flash Code (Red)	LED2 Flash Code (Green)
Control Failure	ON	OFF
Operational Faults		
High-pressure switch fault (not in lockout yet)	1	OFF
System in high-pressure switch lockout	2	OFF
System in low-pressure switch lockout	4	OFF
Low Voltage (<19.2VAC) preventing further relay outputs	5	OFF
Low Voltage (<16 VAC) stopped current relay outputs	6	OFF
High-pressure switch fault (with no communication for compressor operation and where Y1 and Y2 are not energized)	9	ON

SENSOR OR SWITCH FAULT CODES

Table 7 describes the faults that the control can detect when a problem is present with a sensor or switch. The control displays this type of error by energizing LED1 (Red) constantly and flashing LED2 (Green). These faults typically occur when an AC unit has been operating and a problem occurs with a sensor or its wiring. These faults could also occur during installation as the AC unit is configured.

TABLE 7: Sensor or Switch Fault Codes

Description	LED1 Flash Code (Red)	LED2 Flash Code (Green)
Outdoor ambient temperature sensor failure (short)	ON	1
Outdoor ambient temperature sensor failure (open)	ON	2

WIRING RELATED FAULT CODES

Table 8 describes the faults that the control can detect when a problem is present with the system wiring or jumper configurations. The control displays this type of error by flashing LED1 (Red) and energizing LED2 (Green) constantly. These faults typically occur when the AC unit is first installed or when a system component such as the room thermostat or indoor unit is replaced or rewired.

TABLE 8: Wiring Related Fault Codes

Description	LED1 Flash Code (Red)	LED2 Flash Code (Green)
Compressor contactor miswire	1	ON
Y2 present without Y1	2	ON

LOCKOUT MODES

Soft Lockout

The control will cause a soft lockout during the following conditions. Detailed descriptions of the conditions required for the control to enter the soft lockout mode are contained in other sections of this document.

- High-pressure switch
 - Two openings within six hours
- Low-pressure switch
 - One opening of the switch for more than five seconds except under certain conditions.

During the soft lockout mode, the control will do the following.

- De-energize the compressor contactor outputs (M, M1, & M2).
- Energize the LED's with the appropriate flash codes as described elsewhere in this document.
- In **communication applications** the fault code will be stored in the thermostat. (This feature is not available for non communicating applications).

The control will reset the soft lockout condition when any of the following occur following removal of the fault condition.

- Power is cycled to the R or Y1 inputs of the control. This will cause the soft lockout condition to be reset when the thermostat is satisfied or when the thermostat is set to SYSTEM OFF and back to HEAT or COOL mode.
- The TEST terminals are shorted for more than two seconds.

When the soft lockout condition is reset, the control will stop displaying the fault code and will respond to thermostat inputs normally.

Hard Lockout

If four soft lockouts occur within a twelve-hour period, the control will cause a hard lockout condition. These soft lockouts can be caused by the same or different conditions. The control will function in the same way during soft and hard lockout conditions. The difference is in the requirements for resetting the lockout condition. The control will reset the hard lockout condition when any of the following occur following removal of the fault condition.

- Power is removed from the R input of the control.
- The TEST terminals are shorted for more than two seconds.

A hard lockout condition will not be reset when the thermostat is satisfied or when the thermostat is set to SYSTEM OFF and back to HEAT or COOL mode. Power (24 VAC) to the control must be removed and reapplied.

When the hard lockout condition is reset, the control will de-energize the LED's and respond to inputs/communication normally.

Wiring or Setting Related Lockouts

The control will not operate the compressor when the following faults occur. These faults can be reset using the same methods used to reset a soft lockout. However, two occurrences of these faults will not cause a hard lockout condition.

- Presence of Y2 thermostat signal without Y1.

If a compressor wiring error is detected, the control will not operate the compressor. Once the compressor wiring error has been detected, power (24 VAC) must be cycled to the control for the control to sense the wiring change and clear the lockout condition.

COOLING OPERATION

First-Stage Cooling Operation

During first-stage cooling operation, the control will receive a thermostat signal at the Y1 terminal. The control will energize the M compressor output terminal. This signal energizes the coil on the compressor contactor causing the compressor to run.

Second Stage Cooling Operation

During second-stage cooling operation, the control will receive a thermostat signal from Y1 and Y2 inputs. The control will energize both the M and M2 compressor output terminals. The M signal energizes the compressor contactor causing the compressor to run. The M2 signal applies 24VAC to the rectifier plug for the compressor solenoid allowing the compressor to operate in second stage.

HIGH-PRESSURE SWITCH FAULT

The AC Unit is equipped with a high-pressure switch that is connected to the control at the HPS terminals. If the high-pressure switch opens for more than 40 milliseconds, the control will de-energize the compressor and store and display the appropriate fault code. If the pressure switch closes and a thermostat call for compressor operation is present, the control will apply the five-minute anti-short cycle delay timer and start the compressor when the timer expires. If a call for compressor operation is initiated while the high-pressure switch is open, the control will use the logic associated with a high-pressure switch opening during a call for compressor operation.

When the compressor is started following a high-pressure switch fault, the control will start a six-hour timer based on accumulated compressor run time. If the control senses another opening of the high-pressure switch before the timer expires, it will cause a soft lockout condition. The second opening of the high-pressure switch must be greater than 160 milliseconds for the lockout to occur. If the second opening is between 40 and 160 milliseconds, the control will de-energize the compressor but not cause a soft lockout condition. If the control does not sense a second high-pressure switch opening before the six-hour timer expires, the timer and counter will be reset.

LOW-PRESSURE SWITCH FAULT

The AC unit is equipped with a low-pressure switch which is connected to the control at the LPS terminals. If the low-pressure switch opens for more than five seconds, the control will cause a soft lockout condition and display the appropriate fault codes. If the control experiences multiple soft lockouts the control will enter a hard lockout as described in another section of this document. However, the control will ignore the low pressure switch input and not cause a soft lockout condition if it opens during the following conditions.

- First two minutes of compressor operation.
- While TEST input pins are shorted while any thermostat input Y1 or Y2 signal is being received.

OUTDOOR AMBIENT TEMPERATURE SENSOR

Ambient temperature sensor is used in communication applications only. It is used to display outdoor temperature to the home owner via the communicating thermostat.

- Has no effect on operation.
- Not required for operation, but a fault code will be displayed when sensor is not connected or if sensor is shorted.

SECTION IX: WIRING DIAGRAM

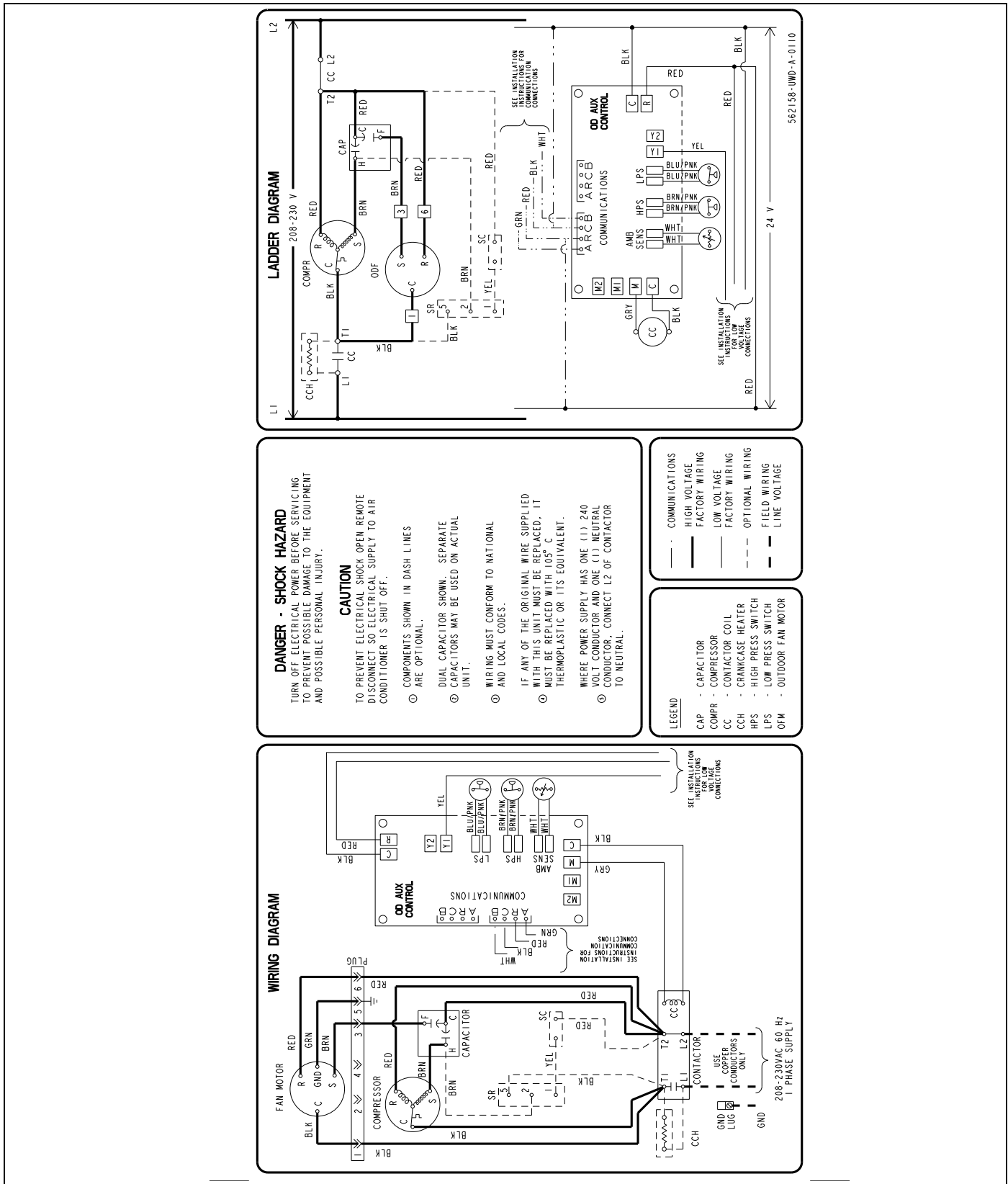

DANGER - SHOCK HAZARD
TURN OFF ELECTRICAL POWER BEFORE SERVICING TO PREVENT POSSIBLE DAMAGE TO THE EQUIPMENT AND POSSIBLE PERSONAL INJURY.

CAUTION
TO PREVENT ELECTRICAL SHOCK OPEN REMOTE DISCONNECT SO ELECTRICAL SUPPLY TO AIR CONDITIONER IS SHUT OFF.

- ⊙ COMPONENTS SHOWN IN DASH LINES ARE OPTIONAL.
- ⊙ DUAL CAPACITOR SHOWN. SEPARATE CAPACITORS MAY BE USED ON ACTUAL UNIT.
- ⊙ WIRING MUST CONFORM TO NATIONAL AND LOCAL CODES.
- ⊙ IF ANY OF THE ORIGINAL WIRE SUPPLIED WITH THIS UNIT MUST BE REPLACED, IT MUST BE REPLACED WITH 105° C THERMOPLASTIC OR ITS EQUIVALENT.
- ⊙ WHERE POWER SUPPLY HAS ONE (1) 240 VOLT CONDUCTOR AND ONE (1) NEUTRAL CONDUCTOR, CONNECT L2 OF CONTACTOR TO NEUTRAL.

LEGEND

- CAP - CAPACITOR
- COMPR - COMPRESSOR
- CC - CONTACTOR COIL
- CCH - CRANKCASE HEATER
- HPS - HIGH PRESS SWITCH
- LPS - LOW PRESS SWITCH
- OTM - OUTDOOR FAN MOTOR

COMMUNICATIONS

- HIGH VOLTAGE FACTORY WIRING
- LOW VOLTAGE FACTORY WIRING
- - - OPTIONAL WIRING
- · - FIELD WIRING
- - - LINE VOLTAGE

FIGURE 13: Wiring Diagram (2 - 4 Ton)

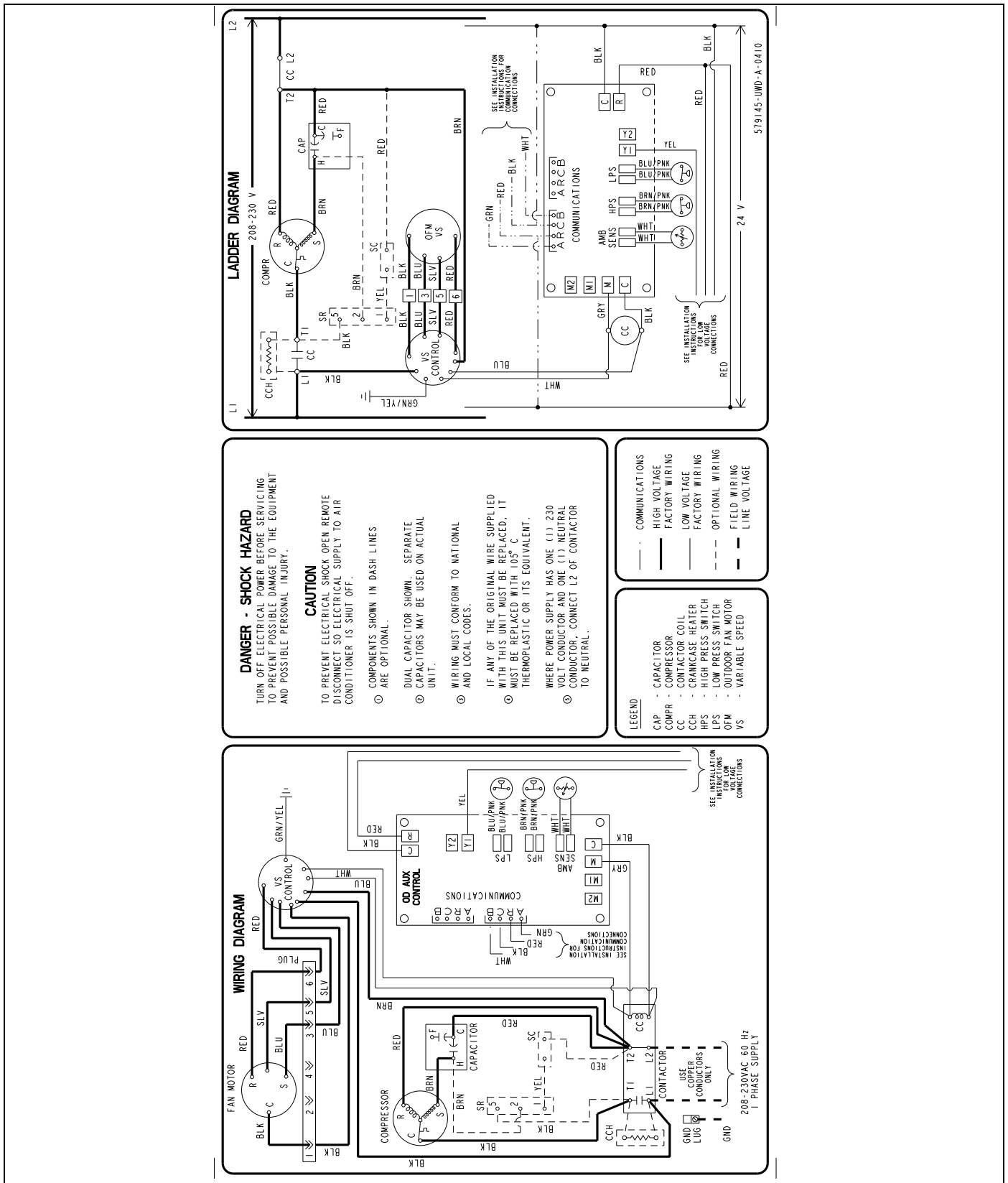

FIGURE 14: Wiring Diagram (5 Ton)

NOTES

Free Manuals Download Website

<http://myh66.com>

<http://usermanuals.us>

<http://www.somanuals.com>

<http://www.4manuals.cc>

<http://www.manual-lib.com>

<http://www.404manual.com>

<http://www.luxmanual.com>

<http://aubethermostatmanual.com>

Golf course search by state

<http://golfingnear.com>

Email search by domain

<http://emailbydomain.com>

Auto manuals search

<http://auto.somanuals.com>

TV manuals search

<http://tv.somanuals.com>