



IDP Series Intrusion Detection and Prevention Appliances

IDP250 Installation Guide

Release 5.0

Juniper Networks, Inc.
1194 North Mathilda Avenue
Sunnyvale, California 94089
USA
408-745-2000
www.juniper.net

Part Number: 530-029729-01, Revision 01

This product includes the Envoy SNMP Engine, developed by Epilogue Technology, an Integrated Systems Company. Copyright © 1986-1997, Epilogue Technology Corporation. All rights reserved. This program and its documentation were developed at private expense, and no part of them is in the public domain.

This product includes memory allocation software developed by Mark Moraes, copyright © 1988, 1989, 1993, University of Toronto.

This product includes FreeBSD software developed by the University of California, Berkeley, and its contributors. All of the documentation and software included in the 4.4BSD and 4.4BSD-Lite Releases is copyrighted by the Regents of the University of California. Copyright © 1979, 1980, 1983, 1986, 1988, 1989, 1991, 1992, 1993, 1994. The Regents of the University of California. All rights reserved.

GateD software copyright © 1995, the Regents of the University. All rights reserved. Gate Daemon was originated and developed through release 3.0 by Cornell University and its collaborators. Gated is based on Kirton's EGP, UC Berkeley's routing daemon (routed), and DCN's HELLO routing protocol. Development of Gated has been supported in part by the National Science Foundation. Portions of the GateD software copyright © 1988, Regents of the University of California. All rights reserved. Portions of the GateD software copyright © 1991, D. L. S. Associates.

This product includes software developed by Maker Communications, Inc., copyright © 1996, 1997, Maker Communications, Inc.

Juniper Networks, the Juniper Networks logo, JUNOS, NetScreen, ScreenOS, and Steel-Belted Radius are registered trademarks of Juniper Networks, Inc. in the United States and other countries. JUNOSe is a trademark of Juniper Networks, Inc. All other trademarks, service marks, registered trademarks, or registered service marks are the property of their respective owners.

Juniper Networks assumes no responsibility for any inaccuracies in this document. Juniper Networks reserves the right to change, modify, transfer, or otherwise revise this publication without notice.

Products made or sold by Juniper Networks or components thereof might be covered by one or more of the following patents that are owned by or licensed to Juniper Networks: U.S. Patent Nos. 5,473,599, 5,905,725, 5,909,440, 6,192,051, 6,333,650, 6,359,479, 6,406,312, 6,429,706, 6,459,579, 6,493,347, 6,538,518, 6,538,899, 6,552,918, 6,567,902, 6,578,186, and 6,590,785.

IDP Series Intrusion Detection and Prevention Appliances IDP250 Installation Guide

Copyright © 2009, Juniper Networks, Inc.

All rights reserved. Printed in USA.

Revision History

May 2009—

The information in this document is current as of the date listed in the revision history.

END USER LICENSE AGREEMENT

READ THIS END USER LICENSE AGREEMENT (“AGREEMENT”) BEFORE DOWNLOADING, INSTALLING, OR USING THE SOFTWARE. BY DOWNLOADING, INSTALLING, OR USING THE SOFTWARE OR OTHERWISE EXPRESSING YOUR AGREEMENT TO THE TERMS CONTAINED HEREIN, YOU (AS CUSTOMER OR IF YOU ARE NOT THE CUSTOMER, AS A REPRESENTATIVE/AGENT AUTHORIZED TO BIND THE CUSTOMER) CONSENT TO BE BOUND BY THIS AGREEMENT. IF YOU DO NOT OR CANNOT AGREE TO THE TERMS CONTAINED HEREIN, THEN (A) DO NOT DOWNLOAD, INSTALL, OR USE THE SOFTWARE, AND (B) YOU MAY CONTACT JUNIPER NETWORKS REGARDING LICENSE TERMS.

1. **The Parties.** The parties to this Agreement are (i) Juniper Networks, Inc. (if the Customer’s principal office is located in the Americas) or Juniper Networks (Cayman) Limited (if the Customer’s principal office is located outside the Americas) (such applicable entity being referred to herein as “Juniper”), and (ii) the person or organization that originally purchased from Juniper or an authorized Juniper reseller the applicable license(s) for use of the Software (“Customer”) (collectively, the “Parties”).

2. **The Software.** In this Agreement, “Software” means the program modules and features of the Juniper or Juniper-supplied software, for which Customer has paid the applicable license or support fees to Juniper or an authorized Juniper reseller, or which was embedded by Juniper in equipment which Customer purchased from Juniper or an authorized Juniper reseller. “Software” also includes updates, upgrades and new releases of such software. “Embedded Software” means Software which Juniper has embedded in or loaded onto the Juniper equipment and any updates, upgrades, additions or replacements which are subsequently embedded in or loaded onto the equipment.

3. **License Grant.** Subject to payment of the applicable fees and the limitations and restrictions set forth herein, Juniper grants to Customer a non-exclusive and non-transferable license, without right to sublicense, to use the Software, in executable form only, subject to the following use restrictions:

a. Customer shall use Embedded Software solely as embedded in, and for execution on, Juniper equipment originally purchased by Customer from Juniper or an authorized Juniper reseller.

b. Customer shall use the Software on a single hardware chassis having a single processing unit, or as many chassis or processing units for which Customer has paid the applicable license fees; provided, however, with respect to the Steel-Belted Radius or Odyssey Access Client software only, Customer shall use such Software on a single computer containing a single physical random access memory space and containing any number of processors. Use of the Steel-Belted Radius or IMS AAA software on multiple computers or virtual machines (e.g., Solaris zones) requires multiple licenses, regardless of whether such computers or virtualizations are physically contained on a single chassis.

c. Product purchase documents, paper or electronic user documentation, and/or the particular licenses purchased by Customer may specify limits to Customer’s use of the Software. Such limits may restrict use to a maximum number of seats, registered endpoints, concurrent users, sessions, calls, connections, subscribers, clusters, nodes, realms, devices, links, ports or transactions, or require the purchase of separate licenses to use particular features, functionalities, services, applications, operations, or capabilities, or provide throughput, performance, configuration, bandwidth, interface, processing, temporal, or geographical limits. In addition, such limits may restrict the use of the Software to managing certain kinds of networks or require the Software to be used only in conjunction with other specific Software. Customer’s use of the Software shall be subject to all such limitations and purchase of all applicable licenses.

d. For any trial copy of the Software, Customer’s right to use the Software expires 30 days after download, installation or use of the Software. Customer may operate the Software after the 30-day trial period only if Customer pays for a license to do so. Customer may not extend or create an additional trial period by re-installing the Software after the 30-day trial period.

e. The Global Enterprise Edition of the Steel-Belted Radius software may be used by Customer only to manage access to Customer’s enterprise network. Specifically, service provider customers are expressly prohibited from using the Global Enterprise Edition of the Steel-Belted Radius software to support any commercial network access services.

The foregoing license is not transferable or assignable by Customer. No license is granted herein to any user who did not originally purchase the applicable license(s) for the Software from Juniper or an authorized Juniper reseller.

4. **Use Prohibitions.** Notwithstanding the foregoing, the license provided herein does not permit the Customer to, and Customer agrees not to and shall not: (a) modify, unbundle, reverse engineer, or create derivative works based on the Software; (b) make unauthorized copies of the Software (except as necessary for backup purposes); (c) rent, sell, transfer, or grant any rights in and to any copy of the Software, in any form, to any third party; (d) remove any proprietary notices, labels, or marks on or in any copy of the Software or any product in which the Software is embedded; (e) distribute any copy of the Software to any third party, including as may be embedded in Juniper equipment sold in the secondhand market; (f) use any ‘locked’ or key-restricted feature, function, service, application, operation, or capability without first purchasing the applicable license(s) and obtaining a valid key from Juniper, even if such feature, function, service, application, operation, or capability is enabled without a key; (g) distribute any key for the Software provided by Juniper to any third party; (h) use the Software in any manner that extends or is broader than the uses purchased by Customer from Juniper or an authorized Juniper reseller; (i) use Embedded Software on non-Juniper equipment; (j) use Embedded Software (or make it available for use) on Juniper equipment that the Customer did not originally purchase from Juniper or an authorized Juniper reseller; (k) disclose the results of testing or benchmarking of the Software to any third party without the prior written consent of Juniper; or (l) use the Software in any manner other than as expressly provided herein.

5. **Audit.** Customer shall maintain accurate records as necessary to verify compliance with this Agreement. Upon request by Juniper, Customer shall furnish such records to Juniper and certify its compliance with this Agreement.

6. **Confidentiality.** The Parties agree that aspects of the Software and associated documentation are the confidential property of Juniper. As such, Customer shall exercise all reasonable commercial efforts to maintain the Software and associated documentation in confidence, which at a minimum includes restricting access to the Software to Customer employees and contractors having a need to use the Software for Customer's internal business purposes.
7. **Ownership.** Juniper and Juniper's licensors, respectively, retain ownership of all right, title, and interest (including copyright) in and to the Software, associated documentation, and all copies of the Software. Nothing in this Agreement constitutes a transfer or conveyance of any right, title, or interest in the Software or associated documentation, or a sale of the Software, associated documentation, or copies of the Software.
8. **Warranty, Limitation of Liability, Disclaimer of Warranty.** The warranty applicable to the Software shall be as set forth in the warranty statement that accompanies the Software (the "Warranty Statement"). Nothing in this Agreement shall give rise to any obligation to support the Software. Support services may be purchased separately. Any such support shall be governed by a separate, written support services agreement. TO THE MAXIMUM EXTENT PERMITTED BY LAW, JUNIPER SHALL NOT BE LIABLE FOR ANY LOST PROFITS, LOSS OF DATA, OR COSTS OR PROCUREMENT OF SUBSTITUTE GOODS OR SERVICES, OR FOR ANY SPECIAL, INDIRECT, OR CONSEQUENTIAL DAMAGES ARISING OUT OF THIS AGREEMENT, THE SOFTWARE, OR ANY JUNIPER OR JUNIPER-SUPPLIED SOFTWARE. IN NO EVENT SHALL JUNIPER BE LIABLE FOR DAMAGES ARISING FROM UNAUTHORIZED OR IMPROPER USE OF ANY JUNIPER OR JUNIPER-SUPPLIED SOFTWARE. EXCEPT AS EXPRESSLY PROVIDED IN THE WARRANTY STATEMENT TO THE EXTENT PERMITTED BY LAW, JUNIPER DISCLAIMS ANY AND ALL WARRANTIES IN AND TO THE SOFTWARE (WHETHER EXPRESS, IMPLIED, STATUTORY, OR OTHERWISE), INCLUDING ANY IMPLIED WARRANTY OF MERCHANTABILITY, FITNESS FOR A PARTICULAR PURPOSE, OR NON-INFRINGEMENT. IN NO EVENT DOES JUNIPER WARRANT THAT THE SOFTWARE, OR ANY EQUIPMENT OR NETWORK RUNNING THE SOFTWARE, WILL OPERATE WITHOUT ERROR OR INTERRUPTION, OR WILL BE FREE OF VULNERABILITY TO INTRUSION OR ATTACK. In no event shall Juniper's or its suppliers' or licensors' liability to Customer, whether in contract, tort (including negligence), breach of warranty, or otherwise, exceed the price paid by Customer for the Software that gave rise to the claim, or if the Software is embedded in another Juniper product, the price paid by Customer for such other product. Customer acknowledges and agrees that Juniper has set its prices and entered into this Agreement in reliance upon the disclaimers of warranty and the limitations of liability set forth herein, that the same reflect an allocation of risk between the Parties (including the risk that a contract remedy may fail of its essential purpose and cause consequential loss), and that the same form an essential basis of the bargain between the Parties.
9. **Termination.** Any breach of this Agreement or failure by Customer to pay any applicable fees due shall result in automatic termination of the license granted herein. Upon such termination, Customer shall destroy or return to Juniper all copies of the Software and related documentation in Customer's possession or control.
10. **Taxes.** All license fees payable under this agreement are exclusive of tax. Customer shall be responsible for paying Taxes arising from the purchase of the license, or importation or use of the Software. If applicable, valid exemption documentation for each taxing jurisdiction shall be provided to Juniper prior to invoicing, and Customer shall promptly notify Juniper if their exemption is revoked or modified. All payments made by Customer shall be net of any applicable withholding tax. Customer will provide reasonable assistance to Juniper in connection with such withholding taxes by promptly: providing Juniper with valid tax receipts and other required documentation showing Customer's payment of any withholding taxes; completing appropriate applications that would reduce the amount of withholding tax to be paid; and notifying and assisting Juniper in any audit or tax proceeding related to transactions hereunder. Customer shall comply with all applicable tax laws and regulations, and Customer will promptly pay or reimburse Juniper for all costs and damages related to any liability incurred by Juniper as a result of Customer's non-compliance or delay with its responsibilities herein. Customer's obligations under this Section shall survive termination or expiration of this Agreement.
11. **Export.** Customer agrees to comply with all applicable export laws and restrictions and regulations of any United States and any applicable foreign agency or authority, and not to export or re-export the Software or any direct product thereof in violation of any such restrictions, laws or regulations, or without all necessary approvals. Customer shall be liable for any such violations. The version of the Software supplied to Customer may contain encryption or other capabilities restricting Customer's ability to export the Software without an export license.
12. **Commercial Computer Software.** The Software is "commercial computer software" and is provided with restricted rights. Use, duplication, or disclosure by the United States government is subject to restrictions set forth in this Agreement and as provided in DFARS 227.7201 through 227.7202-4, FAR 12.212, FAR 27.405(b)(2), FAR 52.227-19, or FAR 52.227-14(ALT III) as applicable.
13. **Interface Information.** To the extent required by applicable law, and at Customer's written request, Juniper shall provide Customer with the interface information needed to achieve interoperability between the Software and another independently created program, on payment of applicable fee, if any. Customer shall observe strict obligations of confidentiality with respect to such information and shall use such information in compliance with any applicable terms and conditions upon which Juniper makes such information available.
14. **Third Party Software.** Any licensor of Juniper whose software is embedded in the Software and any supplier of Juniper whose products or technology are embedded in (or services are accessed by) the Software shall be a third party beneficiary with respect to this Agreement, and such licensor or vendor shall have the right to enforce this Agreement in its own name as if it were Juniper. In addition, certain third party software may be provided with the Software and is subject to the accompanying license(s), if any, of its respective owner(s). To the extent portions of the Software are distributed under and subject to open source licenses obligating Juniper to make the source code for such portions publicly available (such as the GNU General Public License ("GPL") or the GNU Library General Public License ("LGPL")), Juniper will make such source code portions (including Juniper modifications, as appropriate) available upon request for a period of up to three years from the date of distribution. Such request can be made in writing to Juniper Networks, Inc., 1194 N. Mathilda Ave., Sunnyvale, CA 94089, ATTN: General Counsel. You may obtain a copy of the GPL at <http://www.gnu.org/licenses/gpl.html>, and a copy of the LGPL at <http://www.gnu.org/licenses/lgpl.html>.
15. **Miscellaneous.** This Agreement shall be governed by the laws of the State of California without reference to its conflicts of laws principles. The provisions of the U.N. Convention for the International Sale of Goods shall not apply to this Agreement. For any disputes arising under this Agreement, the Parties hereby consent to the personal and exclusive jurisdiction of, and venue in, the state and federal courts within Santa Clara County, California. This Agreement constitutes the entire and sole agreement between Juniper and the Customer with respect to the Software, and supersedes all prior and contemporaneous

agreements relating to the Software, whether oral or written (including any inconsistent terms contained in a purchase order), except that the terms of a separate written agreement executed by an authorized Juniper representative and Customer shall govern to the extent such terms are inconsistent or conflict with terms contained herein. No modification to this Agreement nor any waiver of any rights hereunder shall be effective unless expressly assented to in writing by the party to be charged. If any portion of this Agreement is held invalid, the Parties agree that such invalidity shall not affect the validity of the remainder of this Agreement. This Agreement and associated documentation has been written in the English language, and the Parties agree that the English version will govern. (For Canada: Les parties aux présentes confirment leur volonté que cette convention de même que tous les documents y compris tout avis qui s'y rattache, soient rédigés en langue anglaise. (Translation: The parties confirm that this Agreement and all related documentation is and will be in the English language)).

Table of Contents

	Preface	xi
	Objectives	xi
	Audience	xi
	Documentation Conventions	xi
	Related Documentation	xiii
	Requesting Technical Support	xiv
	Self-Help Online Tools and Resources	xiv
	Opening a Case with JTAC	xv
Part 1	Hardware and Software Overview	
Chapter 1	Hardware Overview	3
	IDP250 Overview	3
	Power Supply	4
	Hard Drive	4
	Fans	4
	System Status LEDs	4
	USB Port	5
	Serial Console Port	5
	Management Interface Port	5
	High Availability Interface Port	6
	Traffic Interface Ports	7
	Copper Ports	7
	Fiber Ports	8
	Traffic Interface Features	9
	Deployment Mode	10
	Internal Bypass	10
	NICs Off	11
	External Bypass	12
	Peer Port Modulation	12
	Layer 2 Bypass	13
Chapter 2	Software Overview	15
	On-Box Software Overview	15
	Centralized Management with NSM Overview	16
	J-Security Center Updates Overview	17

Part 2	Performing the Installation	
Chapter 3	Installation Overview	21
	Before You Begin	21
	Basic Steps	22
Chapter 4	Installing the Appliance to Your Equipment Rack and Connecting Power	23
	Rack Mounting Kits and Required Tools	23
	Mounting to Midmount Brackets	24
	Mounting to Rack Rails	25
	Connecting Power	25
Chapter 5	Performing the Initial Network Configuration and Licensing Tasks	27
	Performing the Initial Configuration	27
	Getting Started with the EasyConfig Wizard (Serial Console Port)	29
	Getting Started with the QuickStart Wizard (Management Port)	30
	Getting Started with the ACM Wizard (Management Port)	31
	Installing the Product License Key	32
Chapter 6	Connecting the IDP Traffic Interfaces to Your Network and Verifying Traffic Flow	35
	Guidelines for Connecting IDP Interfaces to Your Network Devices	35
	Choosing Cables for Traffic Interfaces (Copper Ports)	36
	Connecting Devices That Support Auto-MDIX	36
	Connecting Devices That Do Not Support Auto-MDIX	37
	Connecting Devices to Support Internal Bypass	37
	Connecting and Disconnecting Fiber Cables	37
	Verifying Traffic Flow	38
Part 3	Adding the IDP Appliance to NSM	
Chapter 7	Adding the IDP Appliance to NSM	41
	Reviewing Compatibility with NSM	41
	Adding a Reachable IDP Device to NSM	41

Part 4	Upgrading Software and Installing Field Replaceable Units	
Chapter 8	Upgrading Software	49
	Updating Software (NSM Procedure)	49
	Upgrading Software (CLI Procedure)	51
Chapter 9	Installing Field Replaceable Units	53
	Replacing a Power Supply	53
Chapter 10	Reimaging the Appliance	55
	Reimaging and Relicensing an Appliance	55
Part 5	Technical Specifications and Compliance Statements	
Chapter 11	Technical Specifications	59
	IDP250 Technical Specifications	59
Chapter 12	Compliance Statements	61
	Standards Compliance	61
Chapter 13	Common Criteria EAL2 Compliance	63
	Common Criteria EAL2 Compliance	63
Part 6	Index	
	Index	67

Preface

This preface includes the following topics:

- Objectives on page xi
- Audience on page xi
- Documentation Conventions on page xi
- Related Documentation on page xiii
- Requesting Technical Support on page xiv

Objectives

This guide explains how to install, configure, update, and service an IDP Series Intrusion Detection and Prevention appliance.

Audience

This guide is intended for experienced system and network specialists.

Documentation Conventions

This section provides all the documentation conventions that are followed in this guide. Table 1 on page xi defines notice icons used in this guide.

Table 1: Notice Icons





Icon	Meaning	Description
	Informational note	Indicates important features or instructions.
	Caution	Indicates a situation that might result in loss of data or hardware damage.
	Warning	Alerts you to the risk of personal injury or death.
	Laser warning	Alerts you to the risk of personal injury from a laser.

Table 2 on page xii defines text conventions used in this guide.

Table 2: Text Conventions

Convention	Description	Examples
Bold typeface like this	<ul style="list-style-type: none"> ■ Represents commands and keywords in text. ■ Represents keywords ■ Represents UI elements 	<ul style="list-style-type: none"> ■ Issue the clock source command. ■ Specify the keyword exp-msg. ■ Click User Objects
Bold typeface like this	Represents text that the user must type.	user input
fixed-width font	Represents information as displayed on the terminal screen.	<pre>host1# show ip ospf Routing Process OSPF 2 with Router ID 5.5.0.250 Router is an area Border Router (ABR)</pre>
Key names linked with a plus (+) sign	Indicates that you must press two or more keys simultaneously.	Ctrl + d
<i>Italics</i>	<ul style="list-style-type: none"> ■ Emphasizes words ■ Identifies variables 	<ul style="list-style-type: none"> ■ The product supports two levels of access, <i>user</i> and <i>privileged</i>. ■ <i>clusterID</i>, <i>ipAddress</i>.
The angle bracket (>)	Indicates navigation paths through the UI by clicking menu options and links.	Object Manager > User Objects > Local Objects

Table 3 on page xii defines syntax conventions used in this guide.

Table 3: Syntax Conventions

Convention	Description	Examples
Words in plain text	Represent keywords	terminal length
Words in italics	Represent variables	<i>mask</i> , <i>accessListName</i>
Words separated by the pipe () symbol	Represent a choice to select one keyword or variable to the left or right of this symbol. The keyword or variable can be optional or required.	diagnostic line
Words enclosed in brackets ([])	Represent optional keywords or variables.	[internal external]
Words enclosed in brackets followed by and asterisk ([]*)	Represent optional keywords or variables that can be entered more than once.	[level1 level2 11]*
Words enclosed in braces ({ })	Represent required keywords or variables.	{ permit deny } { in out } { clusterId ipAddress }

Related Documentation

Table 4 on page xiii lists related IDP documentation.

Table 4: Related IDP Documentation

Document	Description
Release notes	Contains information about what is included in a specific product release: supported features, unsupported features, changed features, known problems, and resolved problems. If the information in the release notes differs from the information found in the documentation set, follow the release notes.
ACM Online Help	Available through the Appliance Configuration Manager (ACM). The context-sensitive online help describes how to use the QuickStart and ACM Wizard pages to configure network settings, network interfaces, and NIC features.
<ul style="list-style-type: none"> ■ <i>IDP Series Installation Guide: IDP200, IDP600, IDP1100</i> ■ <i>IDP75 Installation Guide</i> ■ <i>IDP250 Installation Guide</i> ■ <i>IDP800 Installation Guide</i> ■ <i>IDP8200 Installation Guide</i> 	Provides instructions for installing, configuring, updating, and servicing the IDP Series appliances.
<i>IDP Concepts and Examples Guide</i>	Explains IDP features and provides examples of how to use the system.
<i>IDP Administration Guide</i>	Provides procedures for implementing IDP features, monitoring performance, and monitoring security events.
<i>IDP Custom Attack Objects Reference and Examples Guide</i>	Provides in-depth examples and reference information for creating custom attack objects.
<i>IDP Reporter User's Guide</i>	Describes how to use IDP Reporter to view and generate security reports and application usage reports.

Table 4 on page xiii lists related NSM documentation.

Table 5: Related NSM Documentation

Document	Description
Network and Security Manager release notes	Provides information about new features, changed features, fixed problems, and known issues with the NSM release.
<i>Network and Security Manager Installation Guide</i>	Describes how to install the NSM management system on a single server or on separate servers. It also includes information on how to install and run the NSM user interface. This guide is intended for IT administrators responsible for the installation and/or upgrade to NSM.

Table 5: Related NSM Documentation (continued)

Document	Description
<i>Network and Security Manager Configuring Intrusion Detection and Prevention Devices Guide</i>	Describes how to configure and manage IDP devices using NSM. This guide also helps in understanding of how to configure basic and advanced NSM functionality, including adding new devices, deploying new device configurations, updating device firmware, viewing log information, and monitoring the status of IDP devices.
<i>Network and Security Manager Administration Guide</i>	Describes how to use and configure key management features in the NSM. It provides conceptual information, suggested workflows, and examples where applicable. This guide is best used in conjunction with the NSM Online Help, which provides step-by-step instructions for performing management tasks in the NSM UI. This guide is intended for application administrators or those individuals responsible for owning the server and security infrastructure and configuring the product for multi-user systems. It is also intended for device configuration administrators, firewall and VPN administrators, and network security operation center administrators.
Network and Security Manager Online Help	Provides task-oriented procedures describing how to perform basic tasks in the NSM user interface. It also includes a brief overview of the NSM system and a description of the GUI elements.

Requesting Technical Support

Technical product support is available through the Juniper Networks Technical Assistance Center (JTAC). If you are a customer with an active J-Care or JNASC support contract, or are covered under warranty, and need post-sales technical support, you can access our tools and resources online or open a case with JTAC.

- JTAC policies—For a complete understanding of our JTAC procedures and policies, review the JTAC User Guide located at <http://www.juniper.net/customers/support/downloads/710059.pdf>.
- Product warranties—For product warranty information, visit <http://www.juniper.net/support/warranty/>.
- JTAC Hours of Operation —The JTAC centers have resources available 24 hours a day, 7 days a week, 365 days a year.

Self-Help Online Tools and Resources

For quick and easy problem resolution, Juniper Networks has designed an online self-service portal called the Customer Support Center (CSC) that provides you with the following features:

- Find CSC offerings: <http://www.juniper.net/customers/support/>
- Search for known bugs: <http://www2.juniper.net/kb/>
- Find product documentation: <http://www.juniper.net/techpubs/>

- Find solutions and answer questions using our Knowledge Base:
<http://kb.juniper.net/>
- Download the latest versions of software and review release notes:
<http://www.juniper.net/customers/csc/software/>
- Search technical bulletins for relevant hardware and software notifications:
<https://www.juniper.net/alerts/>
- Join and participate in the Juniper Networks Community Forum:
<http://www.juniper.net/company/communities/>
- Open a case online in the CSC Case Management tool: <http://www.juniper.net/cm/>

To verify service entitlement by product serial number, use our Serial Number Entitlement (SNE) Tool located at <https://tools.juniper.net/SerialNumberEntitlementSearch/>.

Opening a Case with JTAC

You can open a case with JTAC on the Web or by telephone.

- Use the Case Management tool in the CSC at <http://www.juniper.net/cm/> .
- Call 1-888-314-JTAC (1-888-314-5822 toll-free in the USA, Canada, and Mexico).

For international or direct-dial options in countries without toll-free numbers, see http://www.juniper.net/support/requesting_support.html

Part 1

Hardware and Software Overview

- Hardware Overview on page 3
- Software Overview on page 15

Chapter 1

Hardware Overview

This chapter includes the following topics:

- IDP250 Overview on page 3
- Power Supply on page 4
- Hard Drive on page 4
- Fans on page 4
- System Status LEDs on page 4
- USB Port on page 5
- Serial Console Port on page 5
- Management Interface Port on page 5
- High Availability Interface Port on page 6
- Traffic Interface Ports on page 7

IDP250 Overview

The IDP250 appliance is optimal for medium central sites or large branch offices. Figure 1 on page 3 shows the location of appliance LEDs and ports.

Figure 1: IDP250 Front Panel

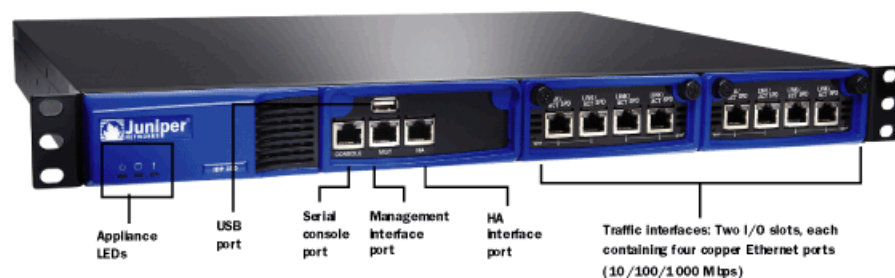

- Related Topics**
- System Status LEDs on page 4
 - USB Port on page 5
 - Serial Console Port on page 5
 - Management Interface Port on page 5
 - High Availability Interface Port on page 6

- Traffic Interface Ports on page 7
- IDP250 Technical Specifications on page 59

Power Supply

The appliance has one power supply. It is a field replaceable unit (FRU).

- Related Topics**
- Replacing a Power Supply on page 53

Hard Drive

The appliance has one 80 GB hard drive. It is not a field replaceable unit (FRU).

Fans



When the system is cool, appliance fans spin at a slower speed to reduce noise and save energy. As the system heats up, the fans run at a faster speed. In the event of fan failure, the appliance fault LED blinks and the remaining fan or fans run at full speed until the failed fan is replaced.

The fans for this model are not field replaceable units (FRUs).

System Status LEDs

Table 6 on page 4 describes system status LED states.

Table 6: System Status LED States

LED	Status	Description
	Solid green	System is powered on.
	Off	System is powered off.
	Flashing amber	Hard disk is active.
	Off	Hard drive has no activity.
	Slowly blinking red	Power failure.
	Quickly blinking red	Fan failure.
	Solid red	Overheating.
	Off	Heat and power are normal.

USB Port

The appliance has a USB port you can use to reimage the appliance, if necessary.

Serial Console Port

The console serial port provides access, using an RJ-45 connector, to the command-line interface (CLI).



NOTE: Although both the console serial port and the management port use RJ-45 connectors, do not plug the network cable into the console serial port.

Management Interface Port

The management interface port is a 10/100/1000 Mbps Ethernet port. In the configuration and logs, the port is `eth0`. Use this port as a dedicated management port, connecting the device to a switch accessible by your management subnet.

The IP address you assign the management port is the IP address you use to connect to the Appliance Configuration Manager (ACM) when you initially configure the device. It is also the address the Network and Security Manager (NSM) uses to connect to the device.

Figure 2 on page 5 shows the management interface port LEDs.

Figure 2: Management Interface Port LEDs



Table 7 on page 5 describes the management interface port LED states.

Table 7: Management Port LEDs

LED	State	Description
LINK	Glows green	Link is present.
	Blinks green	Activity.
	Off	No link is present.

Table 7: Management Port LEDs (continued)

LED	State	Description
TX/RX	Orange	Connection is 1000 Mbps.
	Green	Connection is 100 Mbps.
	Off	If LINK indicates activity, TX/RX off indicates connection is 10 Mbps. If LINK indicates no activity, TX/RX off indicates no activity as well.

High Availability Interface Port

The high availability interface port is a 10/100/1000 Mbps Ethernet port. In the configuration and logs, the port is `eth1`. The high availability interface is a dedicated interface used to share state information among IDP appliances in a high availability cluster.



NOTE: IDP 5.0 does not support high availability.

Figure 3 on page 6 shows the management interface port LEDs.

Figure 3: High Availability Interface Port LEDs

Table 8 on page 6 describes the high availability interface port LED states.

Table 8: High Availability Port LEDs

LED	State	Description
LINK	Glows green	Link is present.
	Blinks green	Activity.
	Off	No link is present.

Table 8: High Availability Port LEDs (continued)

LED	State	Description
TX/RX	Orange	Connection is 1000 Mbps.
	Green	Connection is 100 Mbps.
	Off	If LINK indicates activity, TX/RX off indicates connection is 10 Mbps. If LINK indicates no activity, TX/RX off indicates no activity as well.

Traffic Interface Ports

You use the traffic interface ports to connect the appliance to your network. The interfaces receive and forward traffic. The type and capacity of interface ports vary by model.

The following topics describe features of traffic interface ports:

- Copper Ports on page 7
- Fiber Ports on page 8
- Traffic Interface Features on page 9
- Peer Port Modulation on page 12
- Layer 2 Bypass on page 13

Copper Ports

Figure 4 on page 7 shows copper port LEDs.

Figure 4: Copper Port LEDs

Table 9 on page 8 describes copper port LED states.

Table 9: Copper Port LEDs

LED	State	Description
LINK ACT	Glows green	Link is present.
	Blinks green	Activity.
	Off	No link present.
LINK SPD	Green	Connection is 100 Mbps.
	Yellow	Connection is 1 Gbps.
	Off	If LINK ACT is on, the connection is 10 Mbps. If LINK ACT is off, LINK SPD off indicates no link is present as well.
BYP	Green	Interface is not in bypass mode.
	Yellow	Interface is in bypass mode.
	Off	Interface is turned off (NICs off state).



NOTE: For copper interface ports, if failure or shutdown triggers NICs off state, LINK ACT and LINK SPD LEDs are turned off.

Fiber Ports

Figure 5 on page 8 shows fiber port LEDs.

Figure 5: Fiber Port LEDs

Table 10 on page 9 describes fiber port LED states.

Table 10: Fiber Port LEDs

LED	State	Description
LINK ACT	Glows green	Link is present.
	Flashes green	Activity.
	Off	No link present.
LINK SPD	Green	Connection is 100 Mbps.
	Yellow	Connection is 1 Gbps.
	Orange	Connection is 10 Gbps.
	Off	If LINK ACT is on, the connection is 10 Mbps. If LINK ACT is off, LINK SPD off indicates no link is present as well.
BYP	Green	Interface is not in bypass mode.
	Yellow	Interface is in bypass mode.
	Off	Interface is turned off (NICs off state).



NOTE: For fiber interface ports, if failure or shutdown triggers NICs off state, LINK ACT and LINK SPD LEDs remain lit.

Traffic Interface Features

In IDP deployments, pairs of traffic interfaces are implemented as virtual routers. For example, interface ports eth2 and eth3 form a virtual router vr1. For each virtual router, you use the Appliance Configuration Manager (ACM) to configure the deployment mode (sniffer or transparent) and bypass options (internal, external, or off). The following topics describe these settings:

- Deployment Mode on page 10
- Internal Bypass on page 10
- NICs Off on page 11
- External Bypass on page 12

For guidance on using ACM to configure virtual router settings, see the ACM online help.

Deployment Mode

For each virtual router, you select the deployment mode:

- Sniffer—In an out-of-path, sniffer mode deployment, the IDP appliance can detect attacks but can take only limited action. You connect the IDP traffic interfaces to a mirrored port of a network hub or switch.
- Transparent—In an in-path, transparent mode deployment, traffic arrives in one interface and is forwarded through the other. The IDP appliance detects attacks and takes action according to your security policy rules. You connect the IDP traffic interfaces to firewalls or switches in the network path.

You can deploy a mix of sniffer and transparent mode virtual routers on the same IDP appliance.

For more information on deployment mode, see the *IDP Concepts and Examples Guide*.

Internal Bypass

The Internal Bypass setting supports network security policies that privilege availability over security. In the event of failure or graceful shutdown, with internal bypass configured, the interfaces to enter an internal bypass state. In internal bypass, physical interfaces join mechanically to form a circuit that bypasses IDP processing. For example, if you configure internal bypass for vr0, and the IDP appliance encounters failure or is shut down, eth2 and eth3 join to form a circuit that avoids the IDP engine and forwards the traffic to the next network hop.

Internal bypass operates through a timing mechanism. When enabled, the timer on traffic interfaces counts down to a bypass trigger point. When the IDP appliance is turned on and available, it sends a reset signal to the traffic interface timer so that it does not reach the bypass trigger point. If the IDP operating system encounters failure, then it fails to send the reset signal, the timer counts down to the trigger point, and the traffic interfaces enter a bypass state. If the IDP appliance is shut down gracefully, the traffic interfaces immediately enter bypass.

Figure 6 on page 11 shows the communications path when a virtual router is in internal bypass state.

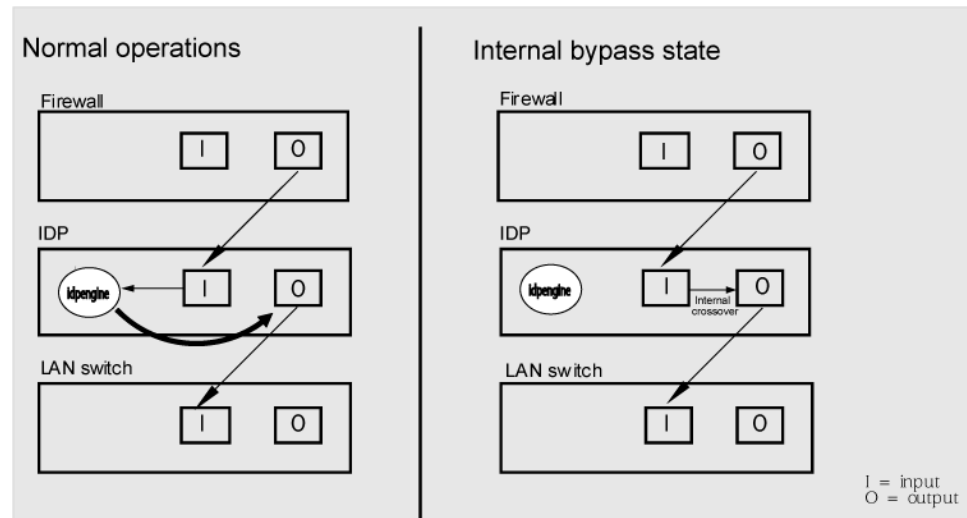
Figure 6: Internal Bypass

When the IDP operating system resumes healthy operations, it sends a reset signal to the traffic interfaces, and the interfaces resume normal operation.



NOTE: All copper port traffic interfaces support internal bypass. Some, but not all, fiber port traffic interfaces support internal bypass. Check with your sales contact for applicable part numbers.



NOTE: Bypass settings are applicable only for deployments where the virtual router is in the network path—transparent mode deployments.



NOTE: The bypass and PPM features are applied independently. The **Internal Bypass** setting is related to the *status of the IDP operating system*. The peer port modulation setting is related to the *status of the link*. It is possible to have a healthy operating system and a link with status down, or a failed operating system and a link with status up.

NICs Off

The NICs Off setting supports network security policies that privilege security over availability. With NICs Off configured, in the event of failure or graceful shutdown, the interfaces are turned off and the IDP appliance becomes a point of failure. If your network design includes redundant network paths, you can configure your routers to detect the downed IDP interfaces and choose an alternate path.

External Bypass

The External Bypass setting supports third-party external bypass units. When the IDP appliance is turned on and available, it sends NetScreen Redundancy Protocol (NSRP) heartbeats to the external bypass unit. When the NSRP packets flow, the external bypass unit allows connections to proceed through the IDP appliance. If IDP encounters failure or is shut down, it cannot send the NSRP packets. IDP traffic interfaces enter a bypass state. When the external bypass unit detects this, it forwards packets around the IDP appliance, according to the rules you configure on the external bypass unit. See Figure 7 on page 12.

Figure 7: Internal Bypass

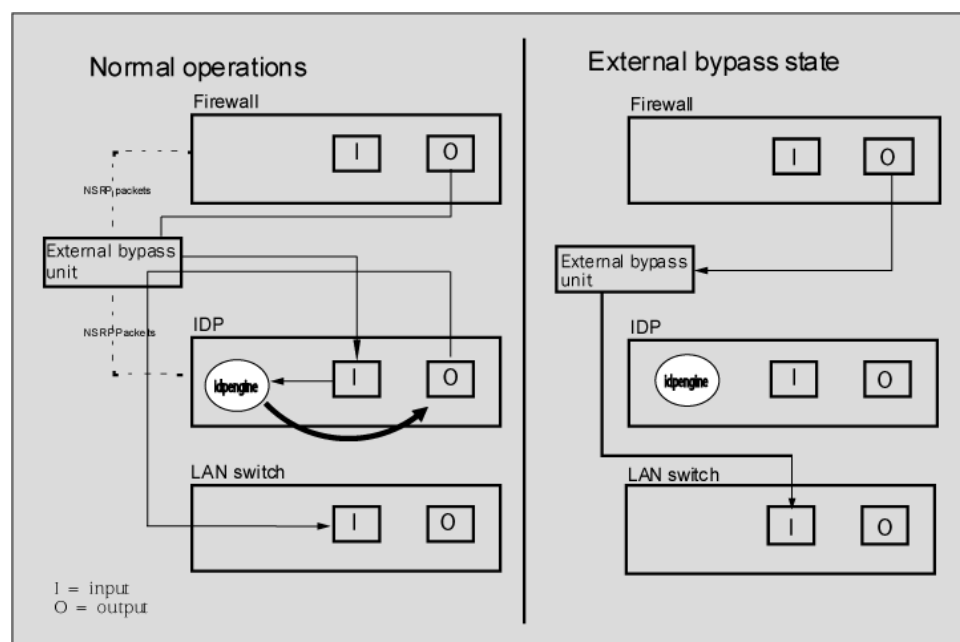

When the IDP appliance resumes healthy operations, it resumes sending NSRP packets. The external bypass unit detects this and allows connections to proceed through the virtual router.

Peer Port Modulation

The peer port modulation (PPM) feature supports deployments where routers monitor link state to make routing decisions. In these deployments, a router might be set to monitor link state on only one side of the IDP appliance. Suppose, for example, the router monitors only the IDP inbound interface. Suppose the inbound interface remains up but the outbound interface goes down. The router watching the inbound link would detect an available link and forward traffic to the IDP appliance. Traffic would be dropped at the point of failure—the outbound link. PPM propagates a link loss state for one traffic interface to all interfaces in the IDP virtual router.

When PPM is enabled, a PPM daemon monitors the health of IDP traffic interfaces belonging to the same virtual router. If a traffic interface loses link, the PPM process turns off any associated network interfaces in the same virtual router so that other network devices detect that the virtual router is down and route around it. For example, assume you have enabled PPM and configured IDP virtual routers as shown in Figure 8 on page 13.

Figure 8: Peer Port Modulation

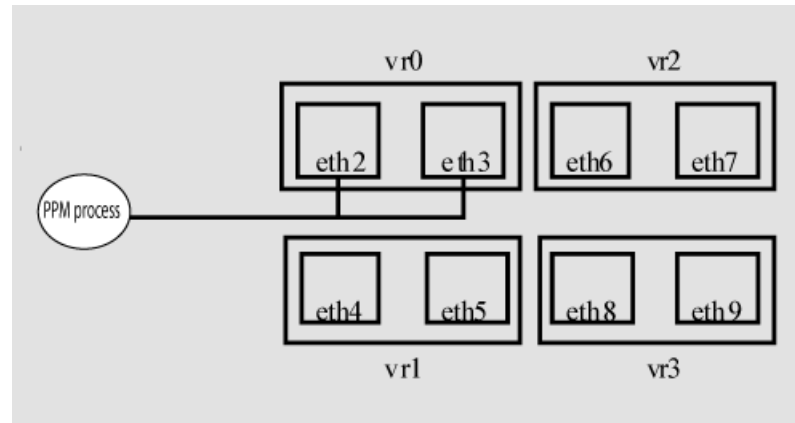

Suppose there is a network problem and eth3 goes down. The PPM daemon detects this and turns off the other interface in vr0: eth2. The interfaces in vr1, vr2, and vr3 are unaffected. After you fix the problem with eth3, the PPM daemon detects this, and turns on eth2.



NOTE: The PPM feature is independent of the bypass feature (NIC state setting). PPM is related to the *status of the link*, not the status of the IDP operating system. A link can be down even when the IDP operating system is healthy. Note, however, that PPM runs as a control plane process and operates only when the IDP appliance is turned on and the control plane is available. If the IDP operating system is unavailable, the PPM feature is also unavailable, regardless of the setting for the NIC state.

Layer 2 Bypass

When you configure virtual routers, you have the option of enabling Layer 2 bypass.

When the IDP appliance is turned on and is operating normally, the traffic interfaces select Layer 3 connections for inspection and process according to security policy rules.

For Layer 2 connections, the interfaces either select traffic for inspection, drop it, or pass it through (uninspected), according to the following rules:

- The interfaces select address resolution protocol (ARP) and internet protocol (IPv4) traffic for inspection and process according to security policy rules.
- By default, the interfaces drop all other Layer 2 traffic.

- If you enable Layer 2 bypass, the interfaces pass through IPv6, internetwork packet exchange (IPX), Cisco Discovery Protocol (CDP), and interior gateway routing protocol (IGRP).
- If you enable internal bypass, the interfaces do not pass through NetScreen Redundancy Protocol (NSRP) packets even if Layer 2 bypass is enabled.
- If you enable external bypass, all interfaces pass through the NSRP packets that are used in communication with the external bypass unit.

Chapter 2

Software Overview

This chapter includes the following topics:

- On-Box Software Overview on page 15
- Centralized Management with NSM Overview on page 16
- J-Security Center Updates Overview on page 17

On-Box Software Overview

You use on-box software to get the appliance up and running in the desired deployment mode, to configure appliance interfaces, and to establish communication with Network and Security Manager (NSM). You can also use on-box utilities to manage appliance processes or generate on-box reports.

Table 11 on page 15 summarizes the IDP on-box management software and utilities.

Table 11: IDP On-Box Utilities

Software	Usage
EasyConfig	<p>When you install a new appliance, you can use the EasyConfig script to assign the appliance an IP address and initialize a simple configuration.</p> <p>To run the EasyConfig script, connect to the serial port console.</p>
QuickStart	<p>When you install a new appliance, you can use QuickStart to deploy the appliance with the default virtual router configured in either sniffer or transparent mode and all configuration defaults.</p> <p>To access QuickStart, connect to the management interface and open the QuickStart URL in your browser.</p>
ACM	<p>When you install a new appliance, you can use ACM to configure the network settings, network interfaces, and user access.</p> <p>To access ACM, connect to the management interface and open the ACM URL in your browser.</p>
scio utility	<p>You can use the <code>scio</code> utility to get or set appliance configuration information.</p> <p>For details, see the <i>IDP Administration Guide</i>.</p>

Table 11: IDP On-Box Utilities (continued)

Software	Usage
idp.sh utility	You can use the <code>idp.sh</code> utility to start, stop, or get status information on appliance processes. For details, see the <i>IDP Administration Guide</i> .
sctop utility	You can use the <code>sctop</code> utility to monitor connection tables and view status. For details, see the <i>IDP Administration Guide</i> .
bypassStatus utility	You can use <code>bypassStatus</code> commands to display settings for the daemon that monitors traffic interface NIC state. For details, see the <i>IDP Administration Guide</i> .
IDP Reporter	You can use the IDP Reporter to view statistics on attacks IDP has detected and responded to, as well as application volume tracking (AVT) statistics. For details, see the <i>IDP Reporter User's Guide</i> .

Centralized Management with NSM Overview

Juniper Networks Network and Security Manager (NSM) is a central management server capable of managing hundreds of IDP appliances and other Juniper Networks devices, such as ScreenOS firewalls, SA Series appliances, and IC Series appliances. You typically deploy NSM in a management subnet accessible to the NSM-managed devices.

Figure 9 on page 16 illustrates the flow of information between the tiers of the central management solution: the NSM user interface, the NSM server, and IDP appliances.

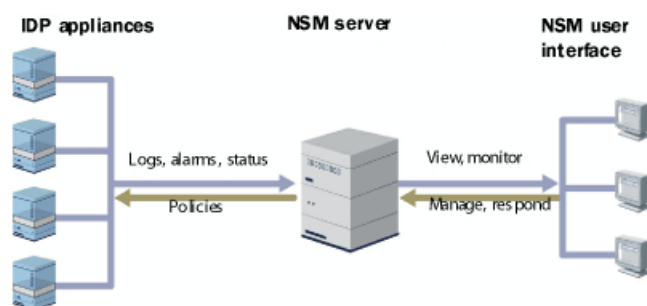
Figure 9: IDP-NSM Communication

The IDP configuration, security policies, attack objects, and log records are stored in NSM server databases and administered using the NSM user interface. Communication between the NSM server and IDP appliances, and between the NSM server and the NSM user interface, is encrypted and authenticated.

For IDP deployments, centralized management provides the following benefits:

- Centralized management for IDP appliances and other network devices
- Consolidated logs from different devices in a single repository
- Centralized management of enterprise security policies
- Simplified management for attack signature updates
- Role-based administration

For information about installing NSM and using NSM distributed management features, management objects (such as address objects, service objects, and templates), and navigational and display features, see the NSM documentation.

J-Security Center Updates Overview

The Juniper Networks Security Center (J-Security Center) routinely makes important updates available to IDP security policy components, including updates to the IDP detector engine and the NSM attack database.

The IDP detector engine is a dynamic protocol decoder that includes support for decoding more than 60 protocols and more than 500 service contexts. You should update IDP detector engine when you first install IDP, whenever you upgrade, and whenever alerted to do so by Juniper Networks. You can view release notes for detector engine updates at

<http://www.juniper.net/techpubs/software/management/idp/de/>.

The NSM attack database stores data definitions for attack objects. Attack objects are patterns comprising stateful signatures and traffic anomalies. Security policy rules direct the IDP engine to inspect traffic for attack objects. We recommend you schedule automatic updates for the NSM attack database.

For more information about detector engine and attack object updates, see the *IDP Administration Guide*.

Part 2

Performing the Installation

- Installation Overview on page 21
- Installing the Appliance to Your Equipment Rack and Connecting Power on page 23
- Performing the Initial Network Configuration and Licensing Tasks on page 27
- Connecting the IDP Traffic Interfaces to Your Network and Verifying Traffic Flow on page 35

Chapter 3

Installation Overview

This chapter includes the following topics:

- Before You Begin on page 21
- Basic Steps on page 22

Before You Begin

The location of the device, the layout of the mounting equipment, and the security of your wiring room are crucial for proper system operation.



CAUTION: To prevent abuse and intrusion by unauthorized personnel, install the appliance in a secure environment.

Observing the following precautions can prevent shutdowns, equipment failures, and injuries:

- Before installation, always check that the power supply is disconnected from any power source.
- Ensure that the room in which you operate the device has adequate air circulation and that the room temperature does not exceed 104°F (40°C).
- Do not place the device in an equipment-rack frame that blocks an intake or exhaust port. Ensure that enclosed racks have fans and louvered sides.
- Correct these hazardous conditions before any installation: moist or wet floors, leaks, ungrounded or frayed power cables, or missing safety grounds.

For a comprehensive presentation on the precautions you must take to prevent personal injury and damage to the equipment, see the *Juniper Networks Security Products Safety Guide*.

Related Topics ■ Common Criteria EAL2 Compliance on page 63

Basic Steps

Take the following basic steps to install the appliance and connect it to your network:

1. Read the release notes for your release. Release notes make you aware of supported and unsupported features, known issues, and fixed issues. Go to <http://www.juniper.net/techpubs/software/management/idp/> and download the release notes for your release.
2. Become familiar with the safety and security guidelines that pertain to your installation. See “Before You Begin” on page 21.
3. Decide on the physical location for the appliance. The location depends on your deployment mode, the location of your network devices, and compliance with your company security policy.
4. Install the appliance into your equipment rack. See Rack Mounting Kits and Required Tools.

Although you can place the appliance on a desktop for operation, we do not recommend deploying it in this manner.

5. Connect power cables and power on. See Connecting Power.
6. Perform the initial configuration steps. See “Performing the Initial Configuration” on page 27.
7. Install the appliance license key. See “Installing the Product License Key” on page 32.



NOTE: In these steps, you are instructed to install the product license key before you add the appliance to NSM. If you install the product license key after you add the appliance to NSM, you must re-add the appliance to NSM.

8. Connect the appliance to your network. See “Guidelines for Connecting IDP Interfaces to Your Network Devices” on page 35.
9. Verify connectivity. See “Verifying Traffic Flow” on page 38.
10. In NSM, add the IDP appliance to the NSM device manager. See “Adding a Reachable IDP Device to NSM” on page 41.
11. Upgrade the IDP software to the current release, update the IDP detector engine firmware, and update the NSM attack object database. See “Updating Software (NSM Procedure)” on page 49.

Chapter 4

Installing the Appliance to Your Equipment Rack and Connecting Power

This chapter includes the following topics:

- Rack Mounting Kits and Required Tools on page 23
- Mounting to Midmount Brackets on page 24
- Mounting to Rack Rails on page 25
- Connecting Power on page 25

Rack Mounting Kits and Required Tools

Table 12 on page 23 describes the rack mounting hardware included in a standard shipment and required tools that are not included in a standard shipment.

Table 12: Rack Mounting Hardware and Required Tools

Hardware	Description
Rack mounting kit	<p>The standard shipment for 1 RU models includes a single pair of mounting brackets/ears. Use the brackets as follows:</p> <ul style="list-style-type: none">■ Position the brackets in the front position to front-mount.■ Position the brackets in the middle position to midmount. <p>If you require additional rack mounting hardware, such as rack rails, contact your sales representative for details on rack mounting kits to suit your needs.</p>
Required tools	<p>The following tools are not included in the standard shipment and are required to install the appliance into an equipment rack:</p> <ul style="list-style-type: none">■ Number 2 Phillips-head screwdriver■ Rack-compatible screws

- Related Topics**
- Mounting to Midmount Brackets on page 24
 - Mounting to Rack Rails on page 25

Mounting to Midmount Brackets

To mount the appliance using the midmount brackets:

1. Attach one rack-mounting bracket to each side of the chassis with the bracket screws.

Figure 10: 1-RU Midmount Bracket



2. With another person, place the chassis into position between rack posts in the equipment rack and align the rack-mounting bracket holes with the rack post holes.



CAUTION: Be sure to leave at least two inches of clearance on the sides of each chassis for the cooling air inlet and exhaust ports.

3. Secure the chassis to the rack with the rack screws.

Related Topics ■ Rack Mounting Kits and Required Tools on page 23

Mounting to Rack Rails

To mount the device to equipment rack rails:

1. Attach the rails to each side of the chassis with the bracket screws. Make sure the hinged brackets are at the back of the device. Make sure the rails are positioned so they reach the back of the rack when the device is mounted.

Figure 11: Rail with Hinged Rear Bracket



2. Rotate the hinges on both rails so that they allow the device to slide into the rack.
3. With another person, slide the chassis and rails into the rack.



CAUTION: Be sure to leave at least two inches of clearance on the sides of each chassis for the cooling air inlet and exhaust ports.

4. Secure the front brackets to the rack.
5. Rotate the rear brackets so they prevent the device from sliding forward.
6. Secure the rear brackets to the rack.

Related Topics ■ Rack Mounting Kits and Required Tools

Connecting Power

Power is provided to the appliance using 90/264 VAC from your facility.

To connect power:

1. Connect the power cable (provided) to the receptacle on the power supply at the rear of each chassis.

2. Connect the other end of the power cable to the electrical outlet.

Chapter 5

Performing the Initial Network Configuration and Licensing Tasks

This chapter includes the following topics:

- Performing the Initial Configuration on page 27
- Getting Started with the EasyConfig Wizard (Serial Console Port) on page 29
- Getting Started with the QuickStart Wizard (Management Port) on page 30
- Getting Started with the ACM Wizard (Management Port) on page 31
- Installing the Product License Key on page 32

Performing the Initial Configuration

We recommend the following workflow to perform the initial configuration:

1. In the machine room, connect your laptop to the serial port and run the EasyConfig script to assign the management interface an IP address you can reach from your subnet.
2. From your desk, run the ACM wizard from your Web browser. Be sure to change the default passwords.

In some circumstances, you might not be able to use the serial console or might prefer to get started with a simple configuration for limited purposes. For these cases, we support alternative methods for getting started. Table 13 on page 28 summarizes the getting started configuration tools.

Table 13: Getting Started Configuration Tools

Getting Started Tool	You Specify:	Defaults Applied:
EasyConfig wizard (Serial port)	<ul style="list-style-type: none"> ■ Management interface IP address and netmask ■ Default route ■ Time zone, date, and time ■ Deployment mode (sniffer or transparent) for the default virtual router(s) 	<ul style="list-style-type: none"> ■ Root password: abc123 ■ Fully qualified domain name: Blank ■ RADIUS support: Disabled ■ Network interfaces: Auto-negotiate speed/duplex ■ Virtual routers: <ul style="list-style-type: none"> ■ Sniffer mode: One virtual router (vr0) ■ Transparent mode: One virtual router for each pair of interfaces ■ NIC State: NICs off ■ DNS: Disabled ■ NTP: Disabled ■ SSH on management port: Enabled ■ Start the ACM process when the appliance starts up: Enabled
QuickStart wizard (Management port)	Same as EasyConfig Wizard.	Same as EasyConfig Wizard.
ACM wizard (Management port)	<ul style="list-style-type: none"> ■ Management interface IP address and netmask ■ Passwords for root and admin ■ Fully qualified domain name ■ Traffic interface configuration (speed/duplex, NIC states, route table) ■ Virtual routers: deployment mode (sniffer or transparent) and NIC bypass (internal, external, or NICs off) ■ Peer port modulation ■ Layer 2 bypass (pass-through) ■ Network services (DNS, NTP, RADIUS, SSH) ■ ACM access ■ NSM connection information ■ One-time password (OTP) for interoperability with Juniper Networks SA Series or UAC devices 	

- Related Topics**
- Getting Started with the EasyConfig Wizard (Serial Console Port) on page 29
 - Getting Started with the QuickStart Wizard (Management Port) on page 30
 - Getting Started with the ACM Wizard (Management Port) on page 31

Getting Started with the EasyConfig Wizard (Serial Console Port)

We recommend you get started by running the EasyConfig wizard to assign an IP address to the management interface. Then, you can access the ACM Wizard from a remote location to complete the appliance configuration.

To perform the initial configuration with the EasyConfig wizard:

1. Connect one end of the provided RJ-45 null modem serial cable to the serial console port located on the front of the appliance chassis.
2. Connect the other end of the cable to the serial port of your laptop.
3. Open a terminal emulation package such as Microsoft Windows HyperTerminal or XModem. The settings for the software should be as follows:
 - 9600 bps
 - 8 data bits
 - No parity generation or checking
 - 1 stop bit
 - No flow control
 - The serial port number where you connected the cable
4. Turn on the appliance.

If nothing appears in the terminal window, press Enter to display the boot messages.

5. Log into the appliance as root with the default password (abc123).



NOTE: After you have completed the initial configuration, we highly recommend that you use ACM to change the default password.

The EasyConfig script runs automatically. The following text appears:

```
Configuring the deployment mode...
The currently supported deployment modes in EasyConfig are the following,

    1. Sniffer <default>
    2. Inline transparent
Choose the deployment mode? [1]
```

6. Press **1** or **2** and press Enter.

The following text appears:

```
Configuring Management interface...
The management interface is currently configured as:
IP: 192.168.1.1
```

```
Mask: 255.255.255.0
```

```
What IP address do you want to configure for the management interface?
[192.168.1.1]
```

7. Type an IP address and press Enter.

The following text appears:

```
What netmask do you want to configure for the management interface?
[255.255.255.0]
```

8. Type your netmask and press **Enter**.

The system configures your interfaces. The following text appears:

```
Configuring default route...
The current default route is: X.X.X.X
Do you want to change the default route? (y/n) [n]
```

9. Type **Y** and press **Enter**.

The following text appears:

```
What IP address do you want to configure as default route? [X.X.X.X]
```

10. Type your default route (gateway address) and press **Enter**.

The system asks if you want to change the system time.

```
Configuring system time...
Currently configured time is Wed Jan 18 16:32:32 PST 2006
```

```
Do you want to change the system time? (y/n) [n]
```

11. Type **N** if the time is correct. If the time is not correct, type **Y** and follow the prompts to change the system time.

Configuration of the management port is now complete. EasyConfig does not run the next time you log into the appliance.

Related Topics ■ Performing the Initial Configuration on page 27

Getting Started with the QuickStart Wizard (Management Port)

If you cannot connect to the serial port, you can run the QuickStart wizard from the management port to assign an IP address to the management interface.

To get started with the QuickStart wizard:

1. Connect one end of an Ethernet cable to the management interface port and the other end to the Ethernet port of your laptop.
2. On your laptop, open a Web browser.
3. In the browser Address or Location box, enter **https://192.168.1.1**.



NOTE: ACM access uses SSL, so you must type **https://** and not **http://**.

4. Log in as the user root with the default password (abc123).



NOTE: After you have completed the initial configuration, we recommend highly that you use ACM to change the default password.

5. Click **QuickStart** to start the QuickStart wizard. Complete the wizard steps as described in the online Help.

If you prefer, you can click **ACM** instead and run the ACM wizard at this point. However, the ACM wizard entails a lengthier configuration. You might be more comfortable running the ACM wizard over the network.

Related Topics ■ Performing the Initial Configuration on page 27

Getting Started with the ACM Wizard (Management Port)

You use the ACM wizard to complete the appliance configuration.

To get started with the ACM wizard:

1. Run the EasyConfig wizard or QuickStart wizard to assign the management interface an IP address you can reach from your subnet.
2. Connect one end of a CAT-5 cable to the management interface port and the other end to the switch or hub (recommended).
3. Verify that the link LED on the management port is green, indicating an active connection.
4. Return to your desk and open a Web browser.
5. In the browser Address or Location box, enter **https:// IP**, where *IP* is the IP address you assigned to the management interface. For example, if you configured the IP address 10.100.200.1, enter **https://10.100.200.1**.



NOTE: ACM access uses SSL, so you must type **https://** and not **http://**.

6. Type the default user name (root) and password (abc123).
7. Click **ACM** to start the ACM wizard. Complete the wizard steps as described in the online Help.

Related Topics ■ Performing the Initial Configuration on page 27

Installing the Product License Key

IDP 4.1 and later releases require you to install a permanent license key.

To install the permanent license key:

1. Open a Web browser and navigate to the Juniper Networks License Management System Tool (LMS tool):

<https://www.juniper.net/lcrs/license.do>

2. Authenticate with your Juniper Networks customer username and password.
3. Use the LMS tool to generate a new license.

You must provide the device serial number. You can locate the serial number in the following ways:

- In ACM, the serial number is displayed in the lower-left hand corner of the home page.
- From the CLI, run the **scio getsystem** command to display system information, including the serial number.

Save the license as a text file named **lic.txt**.

4. Connect to the IDP command-line interface:
 - Use SSH to connect to the IP address or hostname for the management interface. Log in as **admin** and enter **su -** to switch to **root**.
 - If you prefer, make a connection through the serial port and log in as **root**.
5. Use SCP or FTP to copy the license file to the IDP appliance. The IDP appliance does not run an FTP server, so you have to initiate the FTP session from the IDP appliance.
6. Change directory to the temporary directory:

```
[root@localhost ~] cd /tmp
```

7. Change permissions on the file to enable read, write, and execute:

```
[root@localhost ~] chmod 777 lic.txt
```

8. Run the following scio command to add the license key:

```
[root@localhost ~] scio lic add lic.txt
```

9. Run the following scio command to verify you have successfully added the license key:

```
[root@localhost ~] scio lic list
```

```
[root@localhost ~]# scio lic list
ID Machine ID      Issue Date          Expiration          OK
  Feature
-----
1 Upgrade          Tue Apr 25 00:00:00 2006 Sat Apr 25 00:00:00 2009 Y
  idp_key
[root@localhost ~]#
```

Related Topics ■ Basic Steps on page 22

Chapter 6

Connecting the IDP Traffic Interfaces to Your Network and Verifying Traffic Flow

This chapter includes the following topics:

- Guidelines for Connecting IDP Interfaces to Your Network Devices on page 35
- Choosing Cables for Traffic Interfaces (Copper Ports) on page 36
- Connecting and Disconnecting Fiber Cables on page 37
- Verifying Traffic Flow on page 38

Guidelines for Connecting IDP Interfaces to Your Network Devices

We recommend you deploy the IDP appliance between gateway firewalls and DMZ or internal networks.

Table 14 on page 35 provides guidelines for connecting IDP interfaces to your network.

Table 14: Interface Connection Guidelines

Port	Cable Connection Guidelines
Management port	<p>NSM must be able to reach the IDP appliance through this connection.</p> <ol style="list-style-type: none">1. Connect one end of a CAT-5 cable into the MGMT port located at the front of the chassis.2. Connect the other end to a switch or hub (recommended) in your network.

Table 14: Interface Connection Guidelines (continued)

Port	Cable Connection Guidelines
Traffic interface ports	<p>Sniffer Mode – Copper Ports</p> <ol style="list-style-type: none"> 1. Connect one end of a CAT-5 straight-through cable to a traffic interface port located at the front of the chassis. 2. Connect the other end to the Switched Port Analyzer (SPAN) port of a switch or a hub.
	<p>Transparent Mode – Copper Ports</p> <ol style="list-style-type: none"> 1. Connect one end of a CAT-5 straight-through cable to a traffic interface port located at the front of the chassis. 2. Connect the other end to the corresponding port of a firewall, switch, or server. 3. Connect one end of a CAT-5 cable to the outbound port of a traffic interface pair (for example, eth3). 4. Connect the other end to a corresponding the corresponding port of a firewall, switch, or server.
	<p>Transparent Mode – Fiber Ports</p> <ol style="list-style-type: none"> 1. Connect one end of an LC fiber cable to the inbound port of a traffic interface pair. 2. Connect the other end to the corresponding port of the switch. 3. Connect one end of an LC fiber cable to the outbound port of a traffic interface pair. 4. Connect the other end to the corresponding port of the switch.

- Related Topics**
- Choosing Cables for Traffic Interfaces (Copper Ports) on page 36
 - Connecting and Disconnecting Fiber Cables on page 37
 - Verifying Traffic Flow on page 38

Choosing Cables for Traffic Interfaces (Copper Ports)

This topic provides guidelines for choosing the correct cables to connect the appliance to your network devices. It includes the following information:

- Connecting Devices That Support Auto-MDIX on page 36
- Connecting Devices That Do Not Support Auto-MDIX on page 37
- Connecting Devices to Support Internal Bypass on page 37

Connecting Devices That Support Auto-MDIX

If you are connecting devices that support auto-MDIX (medium dependent interface crossover), you can use either straight-through or crossover cables because auto-MDIX negotiates the correct connection.



NOTE: IDP75, IDP250, IDP800, and IDP8200 support auto-MDIX.

Connecting Devices That Do Not Support Auto-MDIX

For connections to a firewall or server, use a crossover cable.

For connections to a switch or hub, use a straight-through cable.



NOTE: Conventionally, crossover cables have an orange outer jacket. If you are not sure if your Cat 5 cable is a crossover or straight-through cable, lay the two ends side-by-side and observe the order of the wire colors. If the colors are in the same order, it is a straight-through cable; otherwise, it is a crossover cable.

Connecting Devices to Support Internal Bypass

When internal bypass activates, it physically connects the pair of traffic interfaces to each other with a crossover connection.

If the device does not support auto-MDIX, take special care to choose the right cables.

Suppose you plan to place the IDP inline between a firewall and a switch. First, take note of the correct cable choice for a direct connection between the firewall and switch. Would you use a straight-through cable or a cross-over cable?

If the two devices would be connected with a straight-through cable, then use a crossover cable between the firewall and IDP and a straight-through cable between IDP and the switch. When internal bypass activates and crosses-over the connection between the IDP traffic interface pair, the connection between the firewall and the switch will flow as if through a straight-through cable.

If the two devices would be connected with a cross-over cable, then use two straight-through cables. When internal bypass activates, this will have the result of creating one, long cross-over cable connecting the devices.

Connecting and Disconnecting Fiber Cables

The following procedures describe how to connect and remove a Gigabit Ethernet cable to and from the transceiver.

To connect a Gigabit Ethernet cable to a transceiver:

1. Hold the cable clip firmly but gently between your thumb and forefinger with your thumb on top of the clip and your finger under the clip. Do not depress the clip ejector on top of the clip.
2. Make sure the transceiver ejector under the port is not pressed in; otherwise, if you attempt to remove the cable the transceiver might come out with the cable still attached.

- Slide the clip into the transceiver port until it clicks into place. Because the fit is close, you may have to apply some pressure to seat the clip. Apply pressure evenly and gently to avoid clip breakage.

To remove a Gigabit Ethernet cable from a transceiver:

- Hold the cable clip firmly but gently between your thumb and forefinger with your thumb on top of the clip and your finger under the clip.
- Use your thumb to gently press the clip ejector on top of the clip. Press down then forward to loosen the clip from the transceiver port.
- Gently but firmly pull the clip from the transceiver port.

Verifying Traffic Flow

Purpose After you have installed the appliance, run the initial network configuration, and connected the appliance to your network, you can perform the following procedure to verify traffic flows through the appliance.

Action To verify that traffic is flowing through the appliance:

- Make sure the appliance is connected to a live traffic feed.
- Connect to the IDP command-line interface:
 - Use SSH to connect to the IP address or hostname for the management interface. Log in as **admin** and enter **su -** to switch to **root**.
 - If you prefer, make a connection through the serial port and log in as **root**.
- Type **sctop** and press **Enter**.
- Type **s** to see status information.
- Examine the following information on the screen:

Protocol	Packets	Flows	Sessions	Peak	Peak Time
Other	2	0	0	1	08/09/2006 03:08:07
ICMP	3	0	0	0	08/08/2006 18:03:51
UDP	3386	3	1	7	08/08/2006 19:31:01
TCP	151164	12	6	9	08/09/2006 07:01:36

Changes in the UDP and TCP flow and session counts indicate traffic is flowing through the appliance.

Related Topics ■ Basic Steps on page 22

Part 3

Adding the IDP Appliance to NSM

- Adding the IDP Appliance to NSM on page 41

Chapter 7

Adding the IDP Appliance to NSM

This chapter includes the following topics:

- Reviewing Compatibility with NSM on page 41
- Adding a Reachable IDP Device to NSM on page 41

Reviewing Compatibility with NSM

Review the release notes for information regarding compatibility between your IDP Series release and NSM release.

In some cases, you might be required to install a schema update on NSM to support the IDP Series release. If so, follow the instructions in the release notes to install the schema update.



NOTE: The schema update is also known as the *forward support update*.

Related Topics ■ Adding a Reachable IDP Device to NSM on page 41

Adding a Reachable IDP Device to NSM

This procedure assumes the IDP device is reachable. A reachable device is a device you have installed and initialized, including configuring an IP address for the management interface and connecting the management interface to the network. You complete the reachable device workflow in cases where you set up the IDP appliance first and add it to NSM second.

For information on a workflow where you add the device to NSM first and set up the IDP appliance second, see the *IDP Administration Guide*.

To import an IDP device with a known IP address:

1. In the NSM navigation tree, select **Device Manager > Devices**.

Figure 12: NSM Add Device Wizard: Add Device

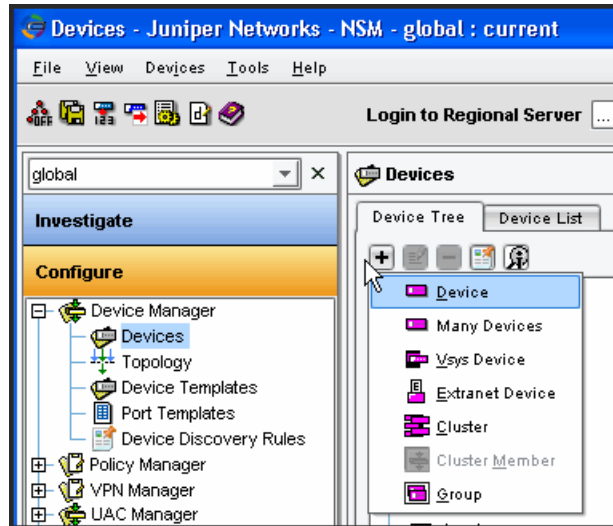

2. Click the + icon and select **Device** to display the Add Device wizard.
3. Select **Device Is Reachable** (default) and click **Next** to display the page where you configure connection settings.

Figure 13: NSM Add Device Wizard: Connection Settings

4. In the Specify Connection Settings dialog box, enter the following connection information:
 - Enter the IP address of the IDP device.
 - Enter **admin** for the username of the device admin user.

- Enter the password for the device admin user. You set the password for admin when you ran the ACM Wizard.
- Enter the password for the device root user. You set the password for root when you ran the ACM Wizard.



NOTE: In NSM, passwords are case-sensitive.

- Select **SSH Version 2** and port 22.

Click **Next**.

The Wizard displays a page where you can verify the integrity of the connection between the IDP appliance and NSM. Please wait a moment as the NSM retrieves SSH key fingerprint information from the IDP appliance.

Figure 14: NSM Add Device Wizard: SSH Key Fingerprint Information

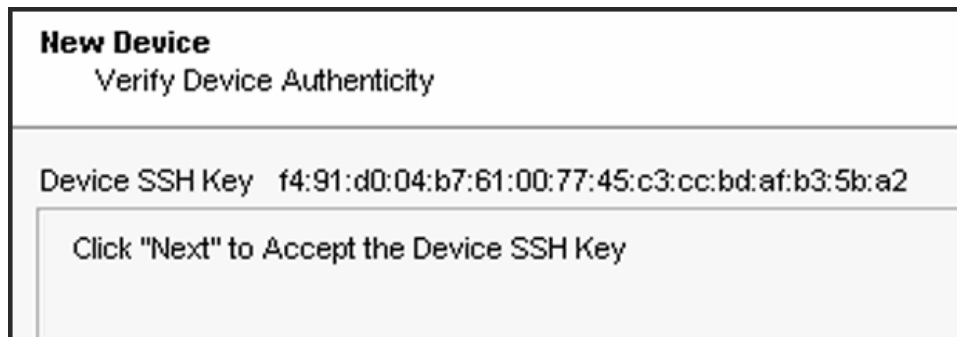

5. Log into the IDP command-line interface and verify the SSH key fingerprint. Comparing the SSH key fingerprint information enables you to detect man-in-the-middle attacks:
 - a. Connect to the IDP command-line interface:
 - Use SSH to connect to the IP address or hostname for the management interface. Log in as **admin** and enter **su -** to switch to **root**.
 - If you prefer, make a connection through the serial port and log in as **root**.
 - b. Enter **cd /etc/ssh**.
 - c. Enter **ssh-keygen -l -f ssh_host_dsa_key**.

The command generates output similar to the following:

```
1024 f4:91:d0:04:b7:61:00:77:45:c3:cc:bd:af:b3:5b:a2 ssh_host_dsa_key.pub
```

After you have verified the SSH key fingerprint matches, click **Next**.

The Wizard displays a page where NSM retrieves and displays inventory information. Please wait a moment as the NSM retrieves inventory information from the IDP appliance.

Figure 15: NSM Add Device Wizard: Inventory Information

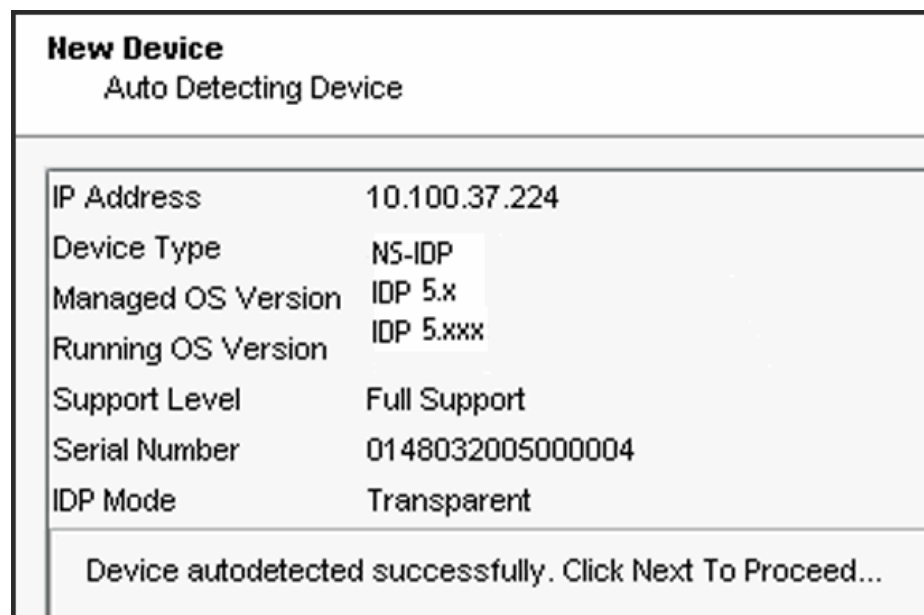

6. Verify that the device type, OS version, device serial number, and device mode are correct.
7. Click **Next** to add the device to NSM. Upon success, NSM displays the following message:

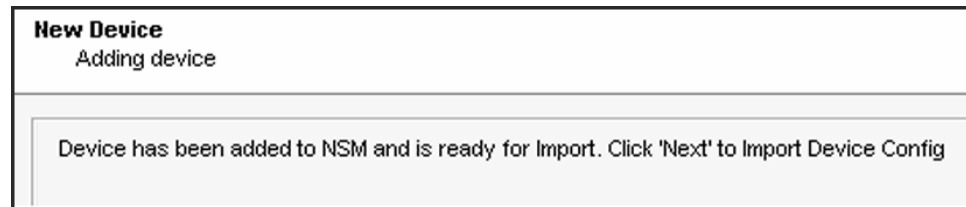
Figure 16: NSM Add Device Wizard: Add Device Confirmation

8. Click **Next** to import the configuration from the IDP device. Upon success, NSM displays the following message:

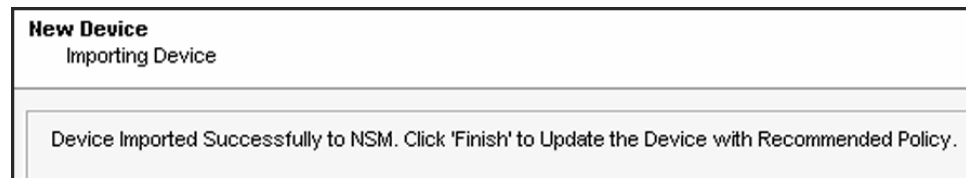
Figure 17: NSM Add Device Wizard: Configuration Import Confirmation

9. Click **Finish**.

For IDP 4.1 and later devices, NSM next runs a job to update the IDP device with the Recommended IDP security policy. The Job Information dialog box shows the status of the Update Device job.

10. After the job is complete, double-click the device in Device Manager to view the imported configuration.

To check the device configuration status, mouse over the device and verify that the device status displays **Managed**.

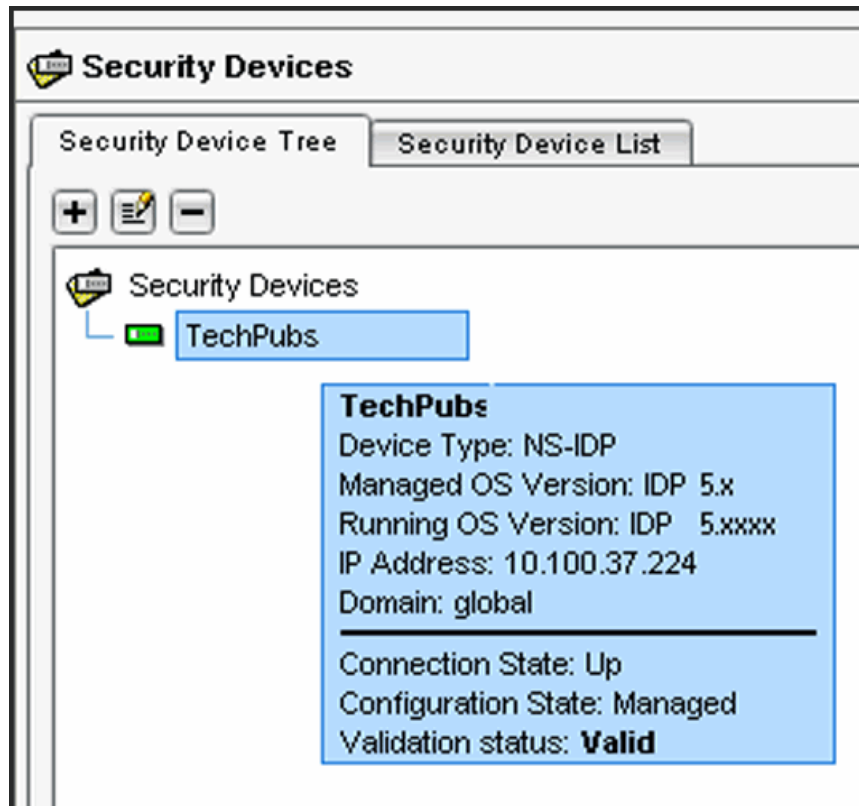
Figure 18: NSM Device Manager: Viewing Device Status

- Related Topics**
- Reviewing Compatibility with NSM on page 41
 - Basic Steps on page 22

Part 4

Upgrading Software and Installing Field Replaceable Units

- Upgrading Software on page 49
- Installing Field Replaceable Units on page 53
- Reimaging the Appliance on page 55

Chapter 8

Upgrading Software

This chapter includes the following topics:

- Updating Software (NSM Procedure) on page 49
- Upgrading Software (CLI Procedure) on page 51

Updating Software (NSM Procedure)

To update IDP software:

1. Add the IDP software to the NSM GUI server.
2. Push the IDP software from the NSM GUI server to one or more IDP devices.

To add an IDP software image to the NSM GUI server:

1. Download the software image:
 - a. Go to <https://www.juniper.net/customers/csc/software/> and log in with your customer username and password.
 - b. Enter the IDP device serial number to display a view of applicable software releases available for download.
 - c. Click the applicable link to display the software download page.
 - d. Download the software to a location you can access from your NSM client.
2. From the NSM main menu, select **Tools > Software Manager** to display the Software Manager dialog box.
3. Click the + button to display the Open dialog box.
4. Select the IDP software image you just downloaded and click **Open** to add the software image to the NSM GUI server.
5. Click **OK**.

To push the software image from the NSM GUI server to IDP devices:

1. From the NSM main menu, select **Devices > Software > Install Device Software** to display the Install Device Software dialog box.
2. From the Select OS Name list, select **ScreenOS/IDP**.

3. From the Select Software Image list, select the image file you just added to the NSM GUI server.
4. In the Select Devices list, select the IDP devices on which to install the software update.
5. Click **Next** and complete the wizard steps.
6. Select **Automate ADM Transformation** to automatically update the Abstract Data Model (ADM) for the device after NSM installs the update.



NOTE: If you clear this setting, the update is installed onto the device, but you cannot manage the device from NSM until the device ADM is updated.

7. Click **Finish** to display upgrade status in the Job Information dialog box.
8. When the upgrade finishes, click **Close** to exit the Job Information dialog box.
9. In the NSM Device Manager, right-click the IDP device and select **Import Device**.

The software upgrade is complete.

Next Steps:

1. Check to see if J-Security Center has released an update for the detector engine or attack database:

From the NSM main menu, select **Tools > View/Update NSM attack database** and complete the wizard steps.

2. Push the updated IDP detector engine to IDP devices:

From the NSM main menu, select **Devices > IDP Detector Engine > Load IDP Detector Engine for ScreenOS** and complete the wizard steps.



NOTE: Updating the IDP detector engine on a device does not require a reboot of the device.

3. Push a security policy update job to update attack objects in use in your security policy:
 - a. In NSM, select **Devices > Configuration > Update Device Config**.
 - b. Select devices to which to push the updates and set update job options.
 - c. Click **OK**.

Related Topics ■ Upgrading Software (CLI Procedure) on page 51

Upgrading Software (CLI Procedure)

To upgrade IDP software from the CLI:

1. Download the software image to a host that runs an FTP server. Follow these steps:
 - a. Go to <https://www.juniper.net/customers/csc/software/> and log in with your customer username and password.
 - b. Navigate to **IDP > ScreenOS Software Downloads (including NSM/Global Pro, STRM, IDP and NetScreen-Remote)**. In the row for IDP, click **5.0**.
 - c. Save the **sensor_version.sh** file (where version is the number that identifies the software release version).
2. Connect to the IDP command-line interface in one of the following ways:
 - Use SSH to connect to the IP address or hostname for the management interface. Log in as **admin** and enter **su -** to switch to **root**.
 - If you prefer, make a connection through the serial port and log in as **root**.



NOTE: To make an SSH connection, you must have enabled SSH for the management port (eth0). For details, see the ACM online Help.

3. Use SCP or FTP to copy the license file to the IDP appliance. The IDP appliance does not run an FTP server, so you have to initiate the FTP session from the IDP appliance.
4. Run the upgrade script by entering **sh sensor_version.sh**, where *version* is the number that identifies the software release version. When the script has finished, enter **reboot**.
5. In the NSM Device Manager, right-click the device, select **Adjust OS Version**, and complete the wizard steps.
6. In the NSM Device Manager, right-click the IDP device and select **Import Device**.

The software upgrade is complete.

- Next Steps:**
1. Download the IDP detector engine and NSM attack database updates to the NSM GUI server:

From the NSM main menu, select **Tools > View/Update NSM attack database** and complete the wizard steps.

2. Push the updated IDP detector engine to IDP devices:

From the NSM main menu, select **Devices > IDP Detector Engine > Load IDP Detector Engine for ScreenOS** and complete the wizard steps.



NOTE: Updating the IDP detector engine on a device does not require a reboot of the device.

3. Push a security policy update job to update attack objects in use in your security policy:
 - a. In NSM, select **Devices > Configuration > Update Device Config**.
 - b. Select devices to which to push the updates and set update job options.
 - c. Click **OK**.

Related Topics ■ Updating Software (NSM Procedure) on page 49

Chapter 9

Installing Field Replaceable Units

This chapter includes the following topics:

- Replacing a Power Supply on page 53

Replacing a Power Supply

The following procedure applies to models for which the power supply is a field replaceable unit (FRU). For information on obtaining spares, contact your Juniper Networks sales representative.

To remove a power supply:

1. Go to the back of the device and locate the power supply you want to remove.
2. Locate the horizontal handle and the red lever in the upper left corner of the power supply.
3. Lift the handle and push the lever to the right to unlatch the power supply.
4. With the lever pushed to the right, pull on the handle firmly to dislodge the power supply from its seating.
5. Let go of the lever and slide out the power supply from the handle.
6. Let go of the handle and use both hands to slide the power supply the rest of the way out.

To install a power supply:

1. Take the new power supply to the back of the device.
2. Hold the power supply with both hands with the red handle on the left side of the power supply.
3. Align the power supply with the empty bay and slide the power supply into the bay.
4. Push firmly until you see and hear the red lever snap into place.

If the other power supply is on and powering the appliance, the appliance emits a high-pitched whine and the power supply LED turns on.

5. Connect a power cord to the new power supply.
6. Attach the other end of the power cord to the power source.

The power supply LED turns amber to indicate that the power supply is receiving power. The LED turns green to indicate that it is receiving power and is giving power to the appliance (only occurs if appliance is on). The high-pitched whine stops and the PS FAIL light on the front of the appliance turns off.

Chapter 10

Reimaging the Appliance

This chapter includes the following topic:

- Reimaging and Relicensing an Appliance on page 55

Reimaging and Relicensing an Appliance

The appliance comes with software preinstalled. If needed, you can reinstall the factory image. This process is known as *reimaging* the appliance. The reimaging process rewrites the disk except for the partition containing `/var/idp`. If necessary and if possible, you should save a copy of data or custom configuration files before reimaging.

If you reimage the appliance, you must also relicense it.

To reimage the appliance:

1. Connect a PC to the console serial port of the device, using the serial cable provided with the appliance.
2. Power off the appliance.
3. Insert the USB flash memory stick that shipped with the appliance into the USB port on the front of the appliance. If you have misplaced your USB flash memory stick, contact Juniper Networks Technical Assistance Center (JTAC).
4. Power on the appliance.

The appliance boots from the USB stick and runs the reimaging process. Follow any prompts on the serial console.

5. When the reimaging process has completed, remove the USB stick and reboot.

Next Steps

1. Configure the appliance as if a new installation.
2. Relicense the appliance.
3. Re-add the appliance to NSM.
4. Push updates to detector engine, attack object, and security policy.

Related Topics

- Performing the Initial Configuration on page 27
- Installing the Product License Key on page 32
- Adding a Reachable IDP Device to NSM on page 41

Part 5

Technical Specifications and Compliance Statements

- Technical Specifications on page 59
- Compliance Statements on page 61
- Common Criteria EAL2 Compliance on page 63

Chapter 11

Technical Specifications

This chapter includes the following topics:

- IDP250 Technical Specifications on page 59

IDP250 Technical Specifications

Table 15 on page 59 lists physical specifications.

Table 15: Physical Specifications

Specification	Value
Form Factor	1 RU
Height	1.69 in. (4.3 cm)
Width	17 in. (43.2 cm)
Depth	15 in. (38.1 cm)
Weight	16.5 lb (7.48 kg)

Table 16 on page 59 lists power specifications.

Table 16: Power Specifications

Specification	Value
AC input voltage	100 to 240 VAC
AC input line frequency	50 to 60 Hz
AC input current	5.0 to 1.5 A
Maximum power	300 W

Table 17 on page 60 lists power cord specifications.

Table 17: Power Cord Specifications

Country	Specifications
United States and Canada	<ul style="list-style-type: none"> ■ UL-approved and CSA-certified ■ Flexible cord minimum spec: No. 18 (1.5 mm²SVT or SJT, 3-conductor ■ Current capacity of 10A minimum ■ Earth-grounding attachment plug with NEMA 5-15P (10A, 125V) configuration

Table 18 on page 60 list environmental specifications.

Table 18: Environmental Specifications

Specification	Value
Operating temperature	41° to 104° F (5° to 40° C)
Storage temperature	-40° to 158° F (-40° to 70° C)
Relative humidity (operating)	8 % to 90 % noncondensing
Relative humidity (storage)	5 % to 95 % noncondensing
Altitude (operating)	10,000 ft (3,048 m)
Altitude (storage)	40,000 ft (12,192 m)

Heat dissipation rates depend on the traffic rate and the number and type of features you have enabled. Table 19 on page 60 provides guidelines.

Table 19: Heat Dissipation Guidelines

Specification	Watts	BTU/hour
Minimum	80	273
Maximum	110	375

Chapter 12

Compliance Statements

This chapter includes the following topic:

- Standards Compliance on page 61

Standards Compliance

Table 20:

Category	Standards Compliance
Safety	<ul style="list-style-type: none">■ UL 60950, Third Edition — Safety of Information Technology Equipment■ CSA C2.22 No. 60950, Third Edition — Safety of Information Technology Equipment■ EN 60950, 2000 — Safety of Information Technology Equipment, including Electrical Business Equipment■ IEC 60950, Third Edition — Safety of Information Technology Equipment, including Electrical Business Equipment
EMI	<ul style="list-style-type: none">■ EN 55022, 1998 Class A■ EN 61000-3-2■ FCC Part 15 Class A■ Industry Canada ICES-003 Class A■ VCCI Class A
Immunity	<ul style="list-style-type: none">■ EN 55024, 1998

- Related Topics** ■ Common Criteria EAL2 Compliance on page 63

Chapter 13

Common Criteria EAL2 Compliance

This chapter includes the following topics:

- Common Criteria EAL2 Compliance on page 63

Common Criteria EAL2 Compliance

Table 21 on page 63 provides guidelines you must observe to deploy and use the IDP appliance in compliance with the Common Criteria EAL2. In addition, you must observe compliance guidelines for Network and Security Manager (NSM), listed in the *Network and Security Manager Administration Guide*.

Table 21: Common Criteria EAL2 Compliance

Category	Guidelines
Intended Usage	<ul style="list-style-type: none">■ The IDP appliance must be connected to the network from which IT systems are to be monitored to collect data or to prevent certain data from passing to or from IT systems.■ The IDP appliance must be appropriately scalable to the IT system that it monitors.■ The IDP appliance must be managed in a manner that allows it to address changes in the IT system that it monitors.■ The IDP appliance, the NSM device server and GUI server, and the NSM UI must be installed on dedicated systems. These dedicated systems must not contain user processes that are not required to operate the IDP system.
Personnel	<ul style="list-style-type: none">■ There must be one or more authorized individuals assigned to manage the IDP appliance, NSM, and the security of the information that they contain.■ The authorized administrators must not be careless, willfully negligent, or hostile and must follow and abide by the instructions provided by the IDP appliance, NSM, and UI documentation.■ The IDP appliance and NSM must be accessed only by authorized users.
Physical Protection	The processing resources of the IDP appliance, the NSM server, and the NSM UI must be located within facilities with controlled access that prevents unauthorized physical access.

- Related Topics**
- Standards Compliance on page 61

Part 6

Index

- Index on page 67

Index

Symbols

1998 Class A compliance.....61

A

ACM15, 31
ACM Online Help.....xiii
adding a device to NSM.....41
audience for documentation.....xi
auto-MDIX.....36

B

BTU/hour.....59
bypassStatus utility.....16

C

Common Criteria EAL2 compliance.....63
compliance
 Common Criteria EAL2.....63
 EMI standards.....61
 immunity standards.....61
connecting power.....25
console serial port.....5
copper ports
 cable guidelines.....36
CSA C2.22 No. 60950 compliance.....61
customer support.....xiv
 contacting JTAC.....xiv

D

DNS, setting.....28

E

EasyConfig15, 29
EMI compliance.....61
EMI compliance specifications.....61
EN 1998 compliance.....61
EN 2000 compliance.....61
EN 55022 compliance.....61
EN 55024 compliance.....61

EN 60950 compliance.....61
EN 61000-3-2 compliance.....61
environmental specifications.....59

F

fault LEDs.....4
FCC Part 15 Class A compliance.....61
fiber ports
 cables.....37

H

HA port
 LEDs.....6
 overview.....6
hard drives
 LEDs.....4
heat dissipation.....59

I

IC Series interoperation.....28
ICES-003 Class A compliance.....61
IDP Administration Guide.....xiii
IDP Concepts and Examples Guide.....xiii
IDP Custom Attack Objects Reference and Examples
 Guide.....xiii
IDP Reporter.....16
IDP Reporter User's Guide.....xiii
IDP Series Installation Guide: IDP200, IDP600,
 IDP1100.....xiii
idp.sh utility.....16
IDP250.....3
IDP250 Installation Guide.....xiii
IDP75 Installation Guide.....xiii
IDP800 Installation Guide.....xiii
IDP8200 Installation Guide.....xiii
IEC 60950 safety compliance.....61
immunity standards.....61
Industry Canada ICES-003 Class A compliance.....61

L

Layer 2 bypass setting.....28

LEDs	
fault.....	4
HA port.....	6
hard drive.....	4
IDP250.....	3
power.....	4
traffic interface.....	7, 8
M	
management interface, choosing cable for.....	35
MDIX.....	36
N	
NSM	
specifying connection information for.....	28
updating software with.....	49
NTP, setting.....	28
O	
one time password.....	28
one-time password for IC Series/SA Series.....	28
P	
ports	
copper.....	36
fiber.....	36
IDP250.....	3
power cord specifications.....	59
power LEDs.....	4
power specifications.....	59
power supplies	
connecting.....	25
replacing.....	53
Q	
QuickStart.....	15, 30
R	
rack mounting kit.....	23
RADIUS, configuring.....	28
reimaging the appliance.....	55
release notes.....	xiii
replacing	
power supplies.....	53
RJ-45 serial port.....	5
S	
SA Series interoperation.....	28
safety compliance standards.....	61
safety guidelines.....	21
scio utility.....	15
scotop utility.....	16, 38
security guidelines.....	21
serial port console.....	5
sniffer mode	
setting.....	28
specifications.....	59
EMI compliance.....	61
immunity.....	61
SSH-access, configuring.....	28
standards	
Common Criteria EAL2.....	63
EMI compliance.....	61
safety compliance.....	61
support, technical <i>See</i> technical support	
T	
technical specifications.....	59
technical support	
contacting JTAC.....	xiv
traffic interfaces	
choosing cables for.....	36
copper ports.....	36
fiber ports.....	36
LEDs.....	7, 8
transparent mode	
setting.....	28
U	
UL 60950 compliance.....	61
updating software	
CLI procedure.....	51
NSM procedure.....	49
USB port.....	5
V	
VCCI Class A compliance.....	61
virtual routers	
default.....	28

Free Manuals Download Website

<http://myh66.com>

<http://usermanuals.us>

<http://www.somanuals.com>

<http://www.4manuals.cc>

<http://www.manual-lib.com>

<http://www.404manual.com>

<http://www.luxmanual.com>

<http://aubethermostatmanual.com>

Golf course search by state

<http://golfingnear.com>

Email search by domain

<http://emailbydomain.com>

Auto manuals search

<http://auto.somanuals.com>

TV manuals search

<http://tv.somanuals.com>