

JVC



ENGLISH

CD RECEIVER

KD-G305

中文

CD 收音組合機

KD-G305

ไทย

เครื่องเล่น CD

KD-G305

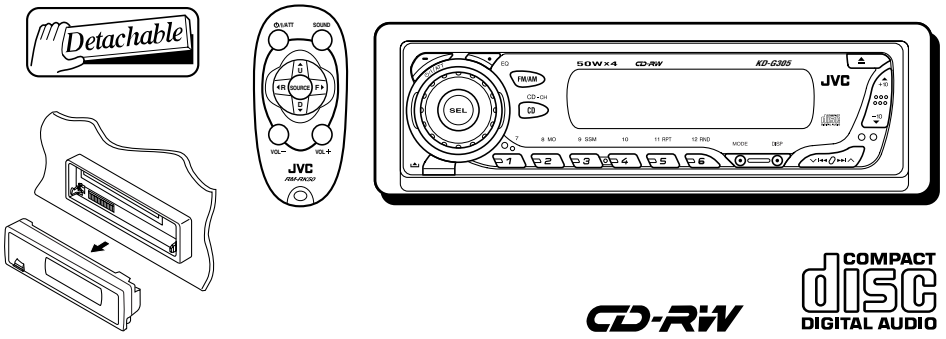

CD-RW **COMPACT disc DIGITAL AUDIO**

- This unit is equipped with the display demonstration. To cancel it, see page 8.
- 本機具有螢幕演示功能。要取消該功能，請參閱第 8 頁。
- เครื่องนี้ได้รับการติดตั้งการสาธิตภาพประกอบ หากต้องการยกเลิก โปรดดู หน้า 8

For installation and connections, refer to the separate manual.

有關安裝和連接方法，分別參閱操作手冊。

กรุณาคู่มือที่แยกต่างหาก ในการติดตั้งและการเชื่อมต่อ



INSTRUCTIONS 使用說明書 คำแนะนำ

GET0181-001A
[U]

IMPORTANT FOR LASER PRODUCTS

1. CLASS 1 LASER PRODUCT
2. **CAUTION:** Do not open the top cover. There are no user serviceable parts inside the unit; leave all servicing to qualified service personnel.
3. **CAUTION:** Visible and invisible laser radiation when open and interlock failed or defeated. Avoid direct exposure to beam.
4. REPRODUCTION OF LABEL: CAUTION LABEL, PLACED OUTSIDE THE UNIT.

CAUTION: Visible and invisible laser radiation when open and interlock failed or defeated. AVOID DIRECT EXPOSURE TO BEAM. (e)	ADVARSEL: Synlig og usynlig laserstråling når maskinen er åben eller interlocken fejler. Undgå direkte eksponering til stråling. (e)	WARNING: Synlig och osynlig laserstråling när den öppnas och spärren är urkopplad. Betrakta ej strålen. (d)	VARO: Avtaesssa ja suojaalkutus ohitettuna tai viallisena olet alittina näkyvälle ja näkymättömälle lasersäteilylle. Vältä säteen kohdistumista suoraan iihsesi. (f)
--	---	--	---

How to reset your unit

After detaching the control panel, press the reset button on the panel holder using a ball-point pen or a similar tool.

This will reset the built-in microcomputer.

Note:

Your preset adjustments—such as preset channels or sound adjustments—will also be erased.

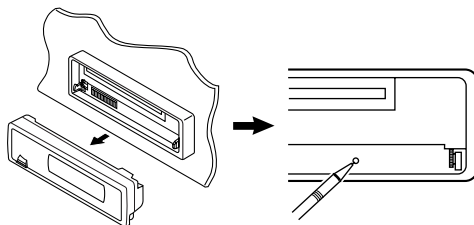

How to use the MODE button

If you press MODE, the unit goes into functions mode, then the number buttons and ▲/▼ buttons work as different function buttons.

Ex.: When number button 2 works as MO (monaural) button.

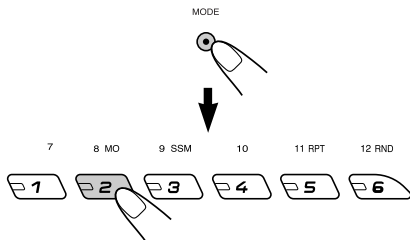

Time countdown indicator

To use these buttons for original functions again after pressing **MODE**, wait for 5 seconds without pressing any of these buttons until the functions mode is cleared.

- Pressing **MODE** again also clears the functions mode.

Thank you for purchasing a JVC product. Please read all instructions carefully before operation, to ensure your complete understanding and to obtain the best possible performance from the unit.

CONTENTS

How to reset your unit	2	SOUND ADJUSTMENTS	18
How to use the MODE button	2	Selecting preset sound modes	
LOCATION OF THE BUTTONS	4	(C-EQ: custom equalizer)	18
Control panel	4	Adjusting the sound	19
Remote controller	5	OTHER MAIN FUNCTIONS	20
Preparing the remote controller	6	Changing the general settings (PSM)	20
BASIC OPERATIONS	7	Detaching the control panel	22
Turning on the power	7	CD CHANGER OPERATIONS	23
Canceling the display demonstration	8	About MP3 discs	23
Setting the clock	9	Playing discs	24
RADIO OPERATIONS	10	Selecting the playback modes	26
Listening to the radio	10	EXTERNAL COMPONENT OPERATIONS ...	27
Storing stations in memory	12	Playing an external component	27
Tuning in to a preset station	13	TROUBLESHOOTING	28
CD OPERATIONS	14	MAINTENANCE	30
Playing a CD	14	Handling discs	30
Locating a track or a particular portion		SPECIFICATIONS	31
on a CD	15		
Selecting CD playback modes	16		
Prohibiting CD ejection	17		

BEFORE USE

***For safety...**

- Do not raise the volume level too much, as this will block outside sounds, making driving dangerous.
- Stop the car before performing any complicated operations.

***Temperature inside the car...**

If you have parked the car for a long time in hot or cold weather, wait until the temperature in the car becomes normal before operating the unit.



LOCATION OF THE BUTTONS

Control panel

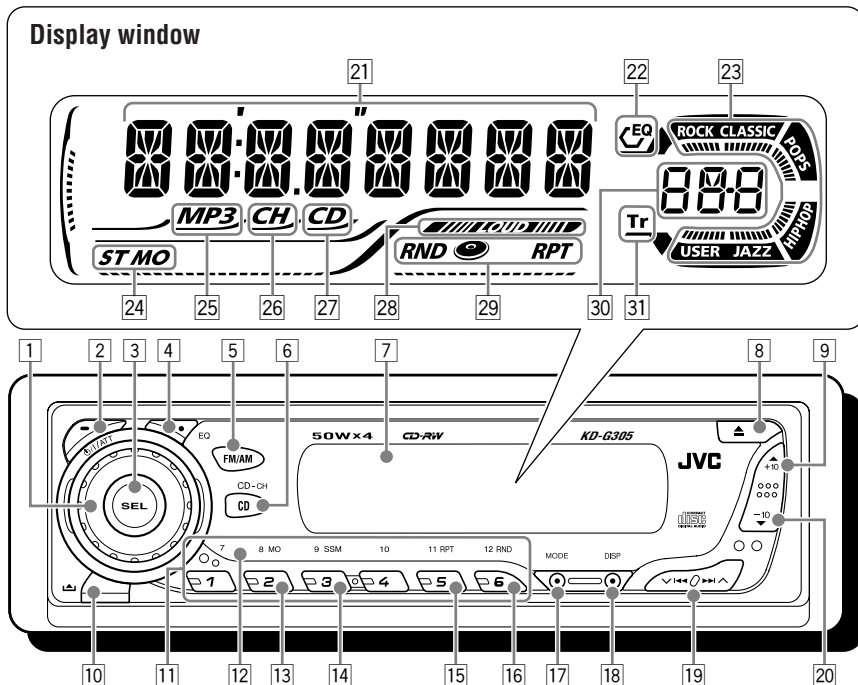

- 1 Control dial
- 2 Φ /I/ATT (standby/on/attenuator) button
- 3 SEL (select) button
- 4 EQ (equalizer) button
- 5 FM/AM button
- 6 CD CD-CH (CD changer) button
- 7 Display window
- 8 \blacktriangle (eject) button
- 9 \blacktriangle (up) button
+10 button
- 10 \blacktriangle (control panel release) button
- 11 Number buttons
- 12 Remote sensor
- 13 MO (monaural) button
- 14 SSM (Strong-station Sequential Memory) button
- 15 RPT (repeat) button
- 16 RND (random) button
- 17 MODE button
- 18 DISP (display) button
- 19 \blacktriangledown \blacktriangleleft \blacktriangleright \blacktriangle buttons
- 20 \blacktriangledown (down) button
-10 button

Display window

- 21 Main display
- 22 EQ (equalizer) indicator
- 23 Sound mode (C-EQ: custom equalizer) indicators
ROCK, CLASSIC, POPS, HIP HOP, JAZZ, USER
 - also works as level meter during play if the level meter is activated (see page 21).
- 24 Tuner reception indicators
ST (stereo), MO (monaural)
- 25 MP3 indicator
 - Lights up only when playing an MP3 disc on a JVC MP3-compatible CD changer.
- 26 CH (CD changer) indicator
- 27 CD indicator
- 28 LOUD (loudness) indicator
- 29 Playback item/mode indicators
RND (random), (disc), RPT (repeat)
- 30 Source display
Volume level indicator
- 31 Tr (track) indicator



Remote controller

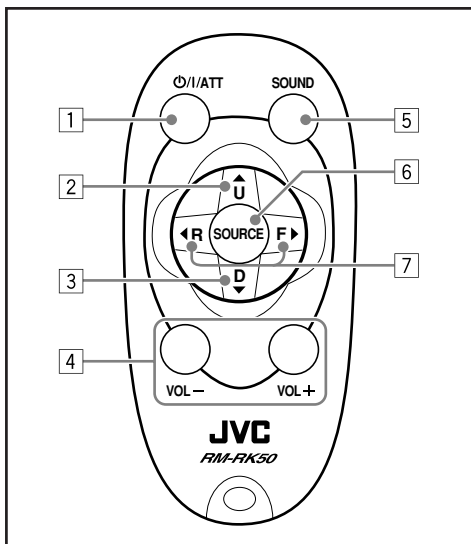

- 1 • Turns on the unit if pressed when the unit is turned off.
 - Turns off the unit if pressed and held until “SEE YOU” appears on the display.
 - Drops the volume level in a moment if pressed briefly.
Press again to resume the volume.
- 2 • Selects the band while listening to the radio. Each time you press the button, the band changes.
 - While playing an MP3 disc on an MP3-compatible CD changer;
 - Skips to the next disc if pressed briefly.
 - Skips to the next folder if pressed and held.

Note: While playing a CD on a CD changer, this always skips to the next disc.
- 3 • Selects the preset stations while listening to the radio. Each time you press the button, the preset station number increases, and the selected station is tuned in.
 - While playing an MP3 disc on an MP3-compatible CD changer;
 - Skips to the previous disc if pressed briefly.
 - Skips to the previous folder if pressed and held.

Note: While playing a CD on a CD changer, this always skips to the previous disc.
- 4 Functions the same as the control dial on the main unit.

Note: These buttons do not function for the preferred setting mode adjustment.
- 5 Selects the sound mode (C-EQ: custom equalizer). Each time you press the button, the sound mode (C-EQ) changes.
- 6 Selects the source. Each time you press the button, the source changes.
- 7 • Searches for stations while listening to the radio.
 - Fast-forwards or reverses the track/file if pressed and held while listening to a disc.
 - Skips to the beginning of the next track/file or goes back to the beginning of the current (or previous) tracks/files if pressed briefly while listening to a disc.

Preparing the remote controller

Before using the remote controller:

- Aim the remote controller directly at the remote sensor on the main unit. Make sure there is no obstacle in between.

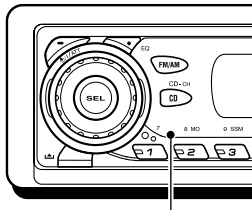

Remote sensor

- Do not expose the remote sensor to strong light (direct sunlight or artificial lighting).

Installing the battery

When the controllable range or effectiveness of the remote controller decreases, replace the battery.

1. Remove the battery holder.

- 1) Push out the battery holder in the direction indicated by the arrow using a ball-point pen or a similar tool.
- 2) Remove the battery holder.

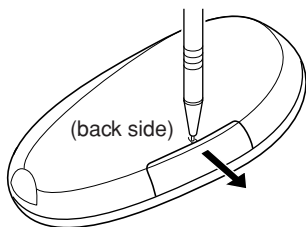

2. Place the battery.

Slide the battery into the holder with the + side facing upwards so that the battery is fixed in the holder.

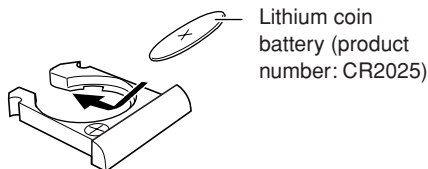

Lithium coin battery (product number: CR2025)

3. Return the battery holder.

Insert again the battery holder by pushing it until you hear a clicking sound.

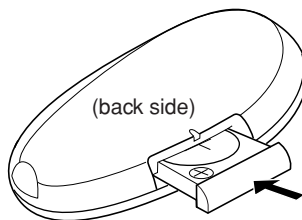

WARNING:

- Store the battery in a place where children cannot reach.
If a child accidentally swallows the battery, consult a doctor immediately.
- Do not recharge, short, disassemble, or heat the battery or dispose of it in a fire.
Doing any of these things may cause the battery to give off heat, crack, or start a fire.
- Do not leave the battery with other metallic materials.
Doing this may cause the battery to give off heat, crack, or start a fire.
- When throwing away or saving the battery, wrap it in tape and insulate; otherwise, the battery may start to give off heat, crack, or start a fire.
- Do not poke the battery with tweezers or similar tools.
Doing this may cause the battery to give off heat, crack, or start a fire.

CAUTION:

DO NOT leave the remote controller in a place (such as dashboards) exposed to direct sunlight for a long time. Otherwise, it may be damaged.

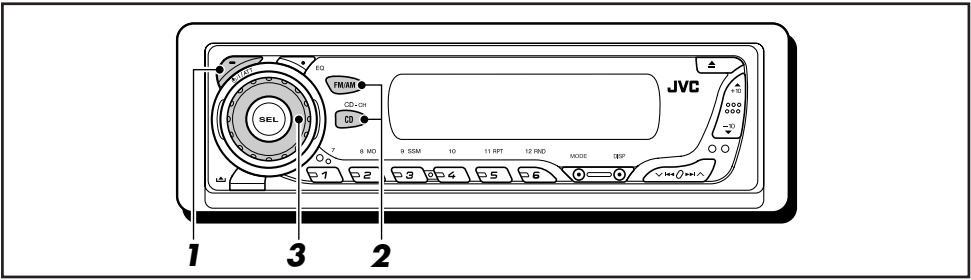

Turning on the power

1 Turn on the power.



Note on One-Touch Operation:

When you select a source in step 2 below, the power automatically comes on. You do not have to press this button to turn on the power.

2 Select the source.

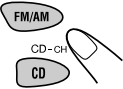

- To operate the tuner (FM or AM), see pages 10 – 13.
- To play a CD, see pages 14 – 17.
- To operate the CD changer, see pages 23 – 26.
- To operate the external component (LINE IN), see page 27.

3 Adjust the volume.

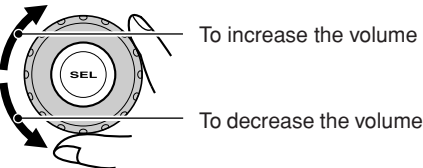

Volume level appears.

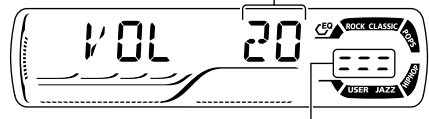

Volume level indicator

4 Adjust the sound as you want. (See pages 18 and 19.)

To drop the volume in a moment

Press **ATT** briefly while listening to any source. "ATT" starts flashing on the display, and the volume level will drop in a moment. To resume the previous volume level, press the button briefly again.

- If you turn the control dial, you can also restore the sound.

To turn off the power

Press and hold **ATT** for more than one second.

"SEE YOU" appears, then the unit turns off.

- **If you turn off the power while listening to a disc**, disc play will start from where playback has been stopped previously, next time you turn on the power.

CAUTION on Volume Setting:

Discs produce very little noise compared with other sources. If the volume level is adjusted for the tuner, for example, the speakers may be damaged by the sudden increase in the output level. Therefore, lower the volume before playing a disc and adjust it as required during playback.

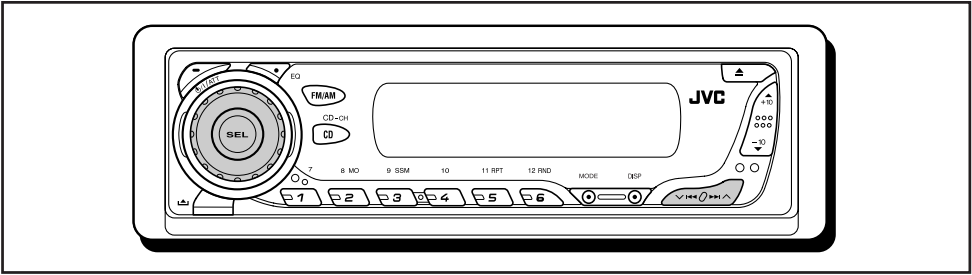

Canceling the display demonstration

When shipped from the factory, display demonstration has been activated, and starts automatically when no operations are done for about 20 seconds.

- It is recommended to cancel the display demonstration before you use the unit for the first time.

To cancel the display demonstration, follow the procedure below:

- 1** Press and hold SEL (select) for more than 2 seconds so that one of the PSM items appears on the display. (PSM: see page 20.)



- 2** Select "DEMO" if not shown on the display.



- 3** Select "DEMO OFF."

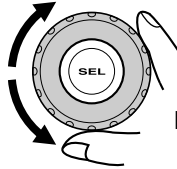

DEMO OFF ↔ DEMO ON



- 4** Finish the setting.



To activate the display demonstration, repeat the same procedure and select "DEMO ON" in step 3.

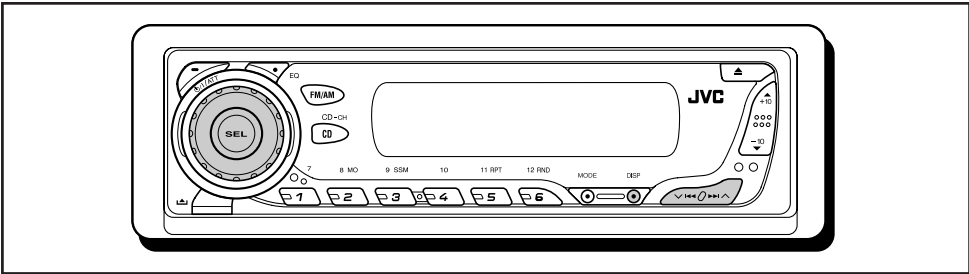

Setting the clock

1 Press and hold SEL (select) for more than 2 seconds so that one of the PSM items appears on the display. (PSM: see page 20.)



2 Set the hour.

- 1 Select "CLOCK H" (hour) if not shown on the display.
- 2 Adjust the hour.

1



2

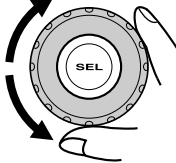

3 Set the minute.

- 1 Select "CLOCK M" (minute).
- 2 Adjust the minute.

1

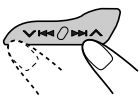

2

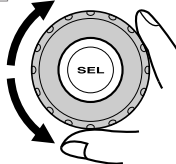

4 Finish the setting.



To check the current clock time or change the display mode



Press DISP (display) repeatedly. Each time you press the button, the display changes as follows:

• During tuner operation:

Frequency ↔ Clock

• During CD operation:

Elapsed playing time ↔ Clock

• During CD changer operation:

Disc number → Clock
 Elapsed playing time ←

• During external component operation:

LINE IN ↔ Clock

• During power off:

The power turns on and the clock time is shown for 5 seconds, then the power turns off.



RADIO OPERATIONS

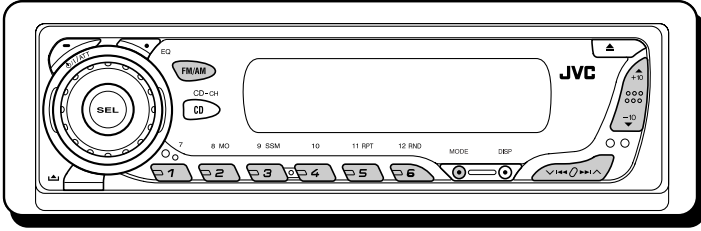

Listening to the radio

You can use either automatic searching or manual searching to tune in to a particular station.

Searching for a station automatically: Auto search

1 Select the band (FM1 – 3, AM).



Each time you press the button, the band changes as follows:

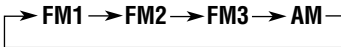

Selected band appears.

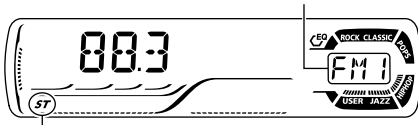

Lights up when receiving an FM stereo broadcast with sufficient signal strength.

Note:

This receiver has three FM bands (FM1, FM2, FM3). You can use any one of them to listen to an FM broadcast.

2 Start searching for a station.



To search for stations of higher frequencies

To search for stations of lower frequencies

When a station is received, searching stops.

To stop searching before a station is received, press the same button you have pressed for searching.

Searching for a station manually: Manual search

1 Select the band (FM1 – 3, AM).



Each time you press the button, the band changes as follows:

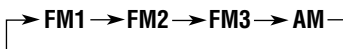

Note:

This receiver has three FM bands (FM1, FM2, FM3). You can use any one of them to listen to an FM broadcast.

2 Press and hold ►►► ▲ or ▼ ◀◀◀ until “M” (manual) starts flashing on the display.



3 Tune in to a station you want while “M” (manual) is still flashing.

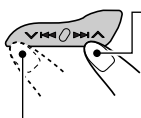

To tune in to stations of higher frequencies

To tune in to stations of lower frequencies

- If you release your finger from the button, the manual mode will automatically turn off after 5 seconds.
- If you hold down the button, the frequency keeps changing (in 50 kHz intervals for FM and 9 kHz for AM) until you release the button.

When an FM stereo broadcast is hard to receive:



1 Press MODE to enter the functions mode while listening to an FM stereo broadcast.

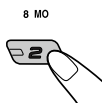

2 Press MO (monaural), while “MODE” is still flashing on the display, so that “MONO” appears on the display. Each time you press the button, the monaural mode turns on and off alternately.

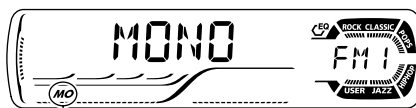

MO (monaural) indicator

When the MO indicator is lit on the display, the sound you hear becomes monaural but the reception will be improved.



Storing stations in memory

You can use one of the following two methods to store broadcasting stations in memory.

- Automatic preset of FM stations: SSM (Strong-station Sequential Memory)
- Manual preset of both FM and AM stations

FM station automatic preset: SSM

You can preset 6 local FM stations in each FM band (FM1, FM2, and FM3).

1 Select the FM band (FM1 – 3) you want to store FM stations into.



Each time you press the button, the band changes as follows:

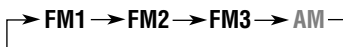

2 Press MODE to enter the functions mode.

MODE



3 Press and hold SSM for about 2 seconds.

9 SSM

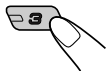

“SSM” flashes, then disappears when automatic preset is over.

Local FM stations with the strongest signals are searched and stored automatically in the band number you have selected (FM1, FM2, or FM3). These stations are preset in the number buttons —No.1 (lowest frequency) to No.6 (highest frequency).

When automatic preset is over, the station stored in number button 1 will be automatically tuned in.

Manual preset

You can preset up to 6 stations in each band (FM1, FM2, FM3, and AM) manually.

Ex.: Storing FM station of 92.5 MHz into the preset number 1 of the FM1 band.

1 Select the band (FM1 – 3, AM) you want to store stations into (in this example, FM1).



Each time you press the button, the band changes as follows:

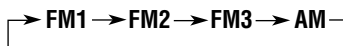

2 Tune in to a station (in this example, of 92.5 MHz).

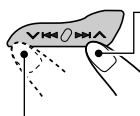

To tune in to stations of higher frequencies

To tune in to stations of lower frequencies



3 Press and hold the number button (in this example, 1) for more than 2 seconds.

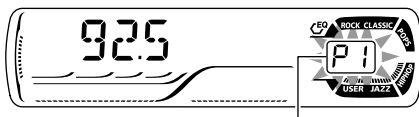
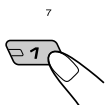

Preset number flashes for a while.

4 Repeat the above procedure to store other stations into other preset numbers.

Notes:

- A previously preset station is erased when a new station is stored in the same preset number.
- Preset stations are erased when the power supply to the memory circuit is interrupted (for example, during battery replacement). If this occurs, preset the stations again.

Tuning in to a preset station

You can easily tune in to a preset station. Remember that you must store stations first. If you have not stored them yet, see “Storing stations in memory” on pages 12 and 13.

1 Select the band (FM1 – 3, AM).



Each time you press the button, the band changes as follows:

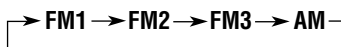

2 Select the number (1 – 6) for the preset station you want.

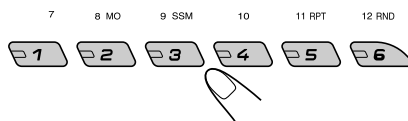

Note:

You can also use the ▲ (up) or ▼ (down) button on the unit to select the next or previous preset stations. Each time you press the ▲ (up) or ▼ (down) button, the next or previous preset station is tuned in.



CD OPERATIONS

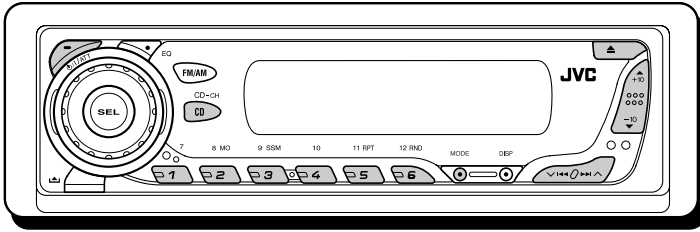

Playing a CD

1 Open the control panel.

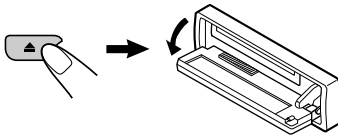

Note on One-Touch Operation:

When a CD is already in the loading slot, pressing CD-CH turns on the unit and starts playback automatically.

2 Insert a CD into the loading slot.

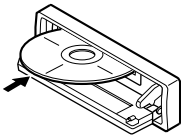

The unit turns on, draws the CD and starts playback automatically.

3 Close the control panel by hand.

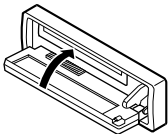

All tracks will be played repeatedly until you stop playback.

The display changes to show the following:

Current source indication

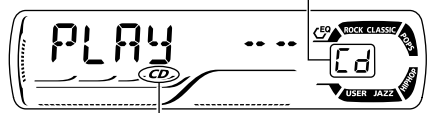

CD indicator

Total playing time of the inserted disc Total track number of the inserted disc

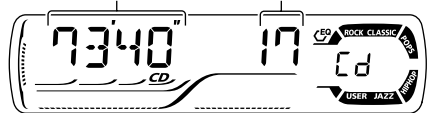

Elapsed playing time Current track number

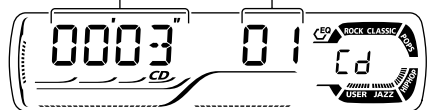

Notes:

- When a CD is inserted upside down, the CD automatically ejects (if the control panel is open). If the control panel is closed, the source changes to the previously selected source, "PLEASE" and "EJECT" appear alternately on the display.
- If there is no CD in the loading slot, you cannot select CD as the source. "NO DISC" appears on the display.



To stop play and eject the CD

Press ▲.

CD play stops and the control panel flips down. The CD automatically ejects from the loading slot. The source changes to the previously selected source.

- If you change the source, CD play also stops (without ejecting the CD).
Next time you select "CD" as the source, CD play starts from where playback has been stopped previously.

Notes:

- *If the ejected CD is not removed for about 15 seconds, the CD is automatically inserted again into the loading slot to protect it from dust. (CD play will not start this time.)*
- *You can eject the CD even when the unit is turned off.*

Locating a track or a particular portion on a CD

To fast-forward or reverse the track

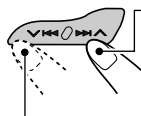

Press and hold ►►| ▲, while playing a CD, to fast-forward the track.

Press and hold ▼ |◄◄, while playing a CD, to reverse the track.

To go to the next or previous tracks

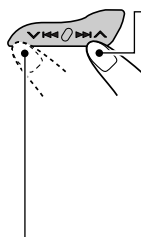

Press ►►| ▲ briefly, while playing a CD, to go ahead to the beginning of the next track.

Each time you press the button consecutively, the beginning of the next tracks is located and played back.

Press ▼ |◄◄ briefly, while playing a CD, to go back to the beginning of the current track. Each time you press the button consecutively, the beginning of the previous tracks is located and played back.

To go to a particular track directly

Press the number button corresponding to the track number to start its playback.

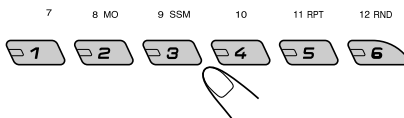

- To select a track number from 1 – 6:
Press 1 (7) – 6 (12) briefly.
- To select a track number from 7 – 12:
Press and hold 1 (7) – 6 (12) for more than one second.



To go to a track quickly (+10 and -10 buttons)

- 1 Press MODE to enter the functions mode while playing a CD.

MODE



- 2 Press +10 or -10.

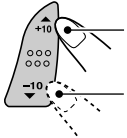

To skip 10 tracks* forwards to the last track



To skip 10 tracks* backwards to the first track

- * First time you press +10 or -10 button, the track skips to the nearest higher or lower track with a track number of multiple ten (ex. 10th, 20th, 30th).

Then each time you press the button, you can skip 10 tracks (see "How to use the +10 and -10 buttons" below).

- After the last track, the first track will be selected, and vice versa.

How to use the +10 and -10 buttons

- Ex. 1: To select track number 32 while playing track number 6

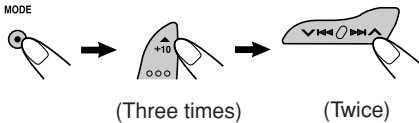

Track 6 → 10 → 20 → 30 → 31 → 32

- Ex. 2: To select track number 8 while playing track number 36

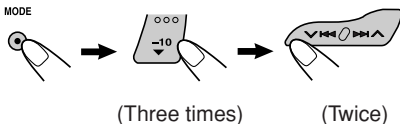

Track 36 → 30 → 20 → 10 → 9 → 8

Selecting CD playback modes

To play back tracks at random (Disc Random Play)

You can play back all tracks on the CD at random.

MODE



- 1 Press MODE to enter the functions mode while playing a CD.

12 RND

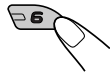

- 2 Press RND (random), while "MODE" is still flashing on the display, so that "DISC RND" appears on the display. Each time you press the button, disc random play mode turns on and off alternately.

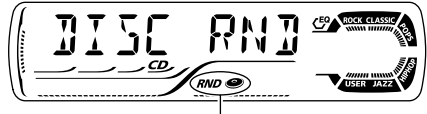

RND and (disc) indicators

When disc random play is turned on, the RND and indicators light up on the display. A track randomly selected starts playing.



To play back tracks repeatedly (Track Repeat Play)

You can play back the current track repeatedly.

MODE



1 Press MODE to enter the functions mode while playing a CD.

11 RPT



2 Press RPT (repeat), while "MODE" is still flashing on the display, so that "TRK RPT" appears on the display. Each time you press the button, track repeat play mode turns on and off alternately.

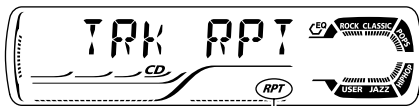

RPT indicator

When track repeat play is turned on, the RPT indicator lights up on the display. The current track starts playing repeatedly.

Prohibiting CD ejection

You can prohibit CD ejection and can lock a CD in the loading slot.

While pressing CD CD-CH, press and hold \odot /I/ATT for more than 2 seconds.

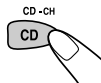

"NO EJECT" flashes on the display for about 5 seconds, and the CD is locked and cannot be ejected.



To cancel the prohibition and unlock the CD

While pressing CD CD-CH, press and hold \odot /I/ATT again for more than 2 seconds.

"EJECT OK" flashes on the display for about 5 seconds, and the CD is unlocked.





SOUND ADJUSTMENTS

Selecting preset sound modes (C-EQ: custom equalizer)

You can select a preset sound mode (C-EQ: custom equalizer) suitable to the music genre.

Select the sound mode you want.



Each time you press the button, the sound modes change as follows:

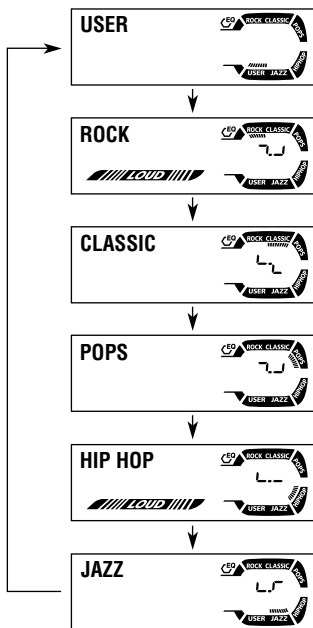

Indication pattern changes for each sound mode except for "USER."



Ex.: When you select "ROCK"

Indication	For:	Preset values		
		BAS	TRE	LOUD
USER	(Flat sound)	00	00	OFF
ROCK	Rock or disco music	+03	+01	ON
CLASSIC	Classical music	+01	-02	OFF
POPS	Light music	+04	+01	OFF
HIP HOP	Funk or rap music	+02	00	ON
JAZZ	Jazz music	+02	+03	OFF

Note:

You can adjust each sound mode to your preference. Once you make an adjustment, it is automatically stored for the currently selected sound mode. See "Adjusting the sound" on page 19.

Adjusting the sound

You can adjust the sound characteristics to your preference.

1 Select the item you want to adjust.



Each time you press the button, the adjustable items change as follows:

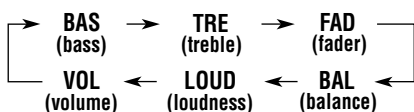

2 Adjust the setting.

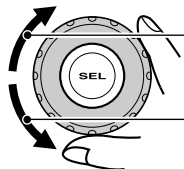

To increase the level or turn on the loudness

To decrease the level or turn off the loudness

Indication pattern changes as you adjust the bass or treble.

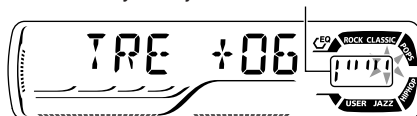

Ex. 1: When you adjust "TRE" (treble)



Ex. 2: When you turn on the loudness

3 Repeat steps 1 and 2 to adjust the other items.

To reset each sound mode to the factory settings, repeat the same procedure and reassign the preset values listed in the table on page 18.

Indication	To do:	Range
BAS* ¹	Adjust the bass.	-06 (min.) +06 (max.)
TRE* ¹	Adjust the treble.	-06 (min.) +06 (max.)
FAD* ²	Adjust the front and rear speaker balance.	R06 (Rear only) F06 (Front only)
BAL	Adjust the left and right speaker balance.	L06 (Left only) R06 (Right only)
LOUD* ¹	Boost low and high frequencies to produce a well-balanced sound at low volume level.	LOUD ON LOUD OFF
VOL* ³	Adjust the volume.	00 (min.) 30 or 50 (max.)* ⁴

*¹ When you adjust the bass, treble, or loudness, the adjustment you have made is stored for the currently selected sound mode (C-EQ) including "USER."

*² If you are using a two-speaker system, set the fader level to "00."

*³ Normally the control dial works as the volume control. So you do not have to select "VOL" to adjust the volume level.

*⁴ Depending on the amplifier gain control setting. (See page 21 for details.)



OTHER MAIN FUNCTIONS

Changing the general settings (PSM)

You can change the items listed in the table below by using the PSM (Preferred Setting Mode) control.

Basic Procedure

1 Press and hold SEL (select) for more than 2 seconds so that one of the PSM items appears on the display. (See below.)



2 Select the PSM item you want to adjust.

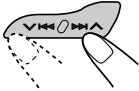

3 Adjust the PSM item selected.

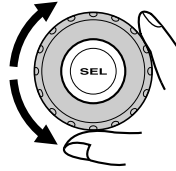

4 Repeat steps 2 and 3 to adjust the other PSM items if necessary.

5 Finish the setting.



Preferred Setting Mode (PSM) items

• For detailed operations of each PSM items, refer to the pages listed in the table.

Indications		Selectable values/items		Factory-preset settings	See page
DEMO	Display demonstration	DEMO OFF	DEMO ON	DEMO ON	8
CLOCK H	Hour adjustment	1 – 12		1 (1:00)	9
CLOCK M	Minute adjustment	00 – 59		00 (1:00)	9
LEVEL	Level display	OFF	ON	ON	21
DIMMER	Dimmer mode	AUTO ↕	↔ ON	OFF ↕	AUTO 21
EXT IN*	External component	CHANGER	LINE IN	CHANGER	21
AMP GAIN	Amplifier gain control	LOW PWR	HIGH PWR	HIGH PWR	21

* Displayed only when one of the following sources is selected—FM, AM, and CD.



To select the level meter—LEVEL

You can activate or deactivate the level meter according to your preference.

When shipped from the factory, level meter is activated.

- ON: Shows the audio level indicator.
- OFF: Cancels the audio level indicator; sound mode indicator is shown.

To select the dimmer mode—DIMMER

When you turn on the car headlights, the display automatically dims (Auto Dimmer).

When shipped from the factory, Auto Dimmer mode is activated.

- AUTO: Activates Auto Dimmer.
- OFF: Cancels Auto Dimmer.
- ON: Always dims the display.

Note:

Auto Dimmer equipped for this unit may not work correctly on some vehicles, particularly on those having a control dial for dimming.

In this case, set the dimmer mode to “ON” or “OFF.”

To select the external component to use—EXT IN

You can connect the external component to the CD changer jack on the rear using the Line Input Adapter KS-U57 (not supplied).

To use the external component as the playback source through this unit, you need to select which component—CD changer or external component—to use.

When shipped from the factory, CD changer is selected as the external component.

- CHANGER: To use the CD changer.
- LINE IN: To use the external component other than CD changer.

Note:

For connecting the Line Input Adapter KS-U57 and the external component, refer to the Installation/Connection Manual (separate volume).

To select the amplifier gain control—AMP GAIN

You can change the maximum volume level of this unit. When the maximum power of the speakers is less than 50 W, select “LOW PWR” to prevent them from being damaged.

When shipped from the factory, “HIGH PWR” is selected.

- LOW PWR: You can adjust the volume level from “VOL 00” to “VOL 30.”

Note:

If you change the setting from “HIGH PWR” to “LOW PWR” while listening at a volume level more than 30, the unit automatically changes the volume level to “VOL 30.”

- HIGH PWR: You can adjust the volume level from “VOL 00” to “VOL 50.”



Detaching the control panel

You can detach the control panel when leaving the car.

When detaching or attaching the control panel, be careful not to damage the connectors on the back of the control panel and on the panel holder.

Detaching the control panel

Before detaching the control panel, be sure to turn off the power.

1 Unlock the control panel.

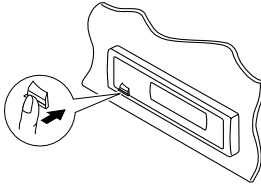

2 Pull the control panel out of the unit.

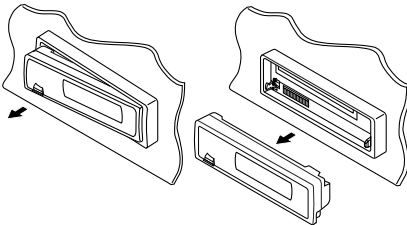

3 Put the detached control panel into the provided case.

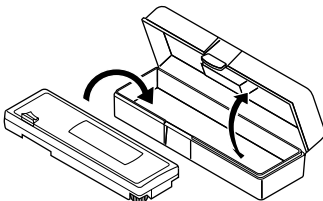

Attaching the control panel

1 Insert the right side of the control panel into the groove on the panel holder.

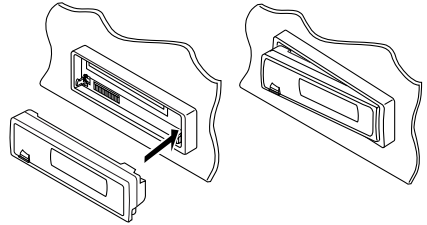

2 Press the left side of the control panel to fix it to the panel holder.

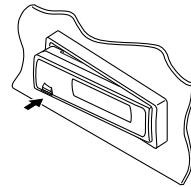

Note on cleaning the connectors:

If you frequently detach the control panel, the connectors will deteriorate.

To minimize this possibility, periodically wipe the connectors with a cotton swab or cloth moistened with alcohol, being careful not to damage the connectors.

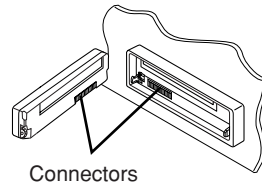

CD CHANGER OPERATIONS

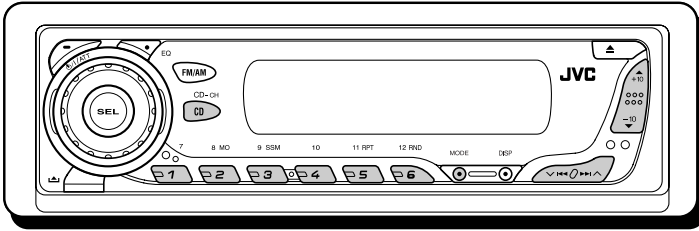

We recommend that you use the JVC MP3-compatible CD changer with your unit.

By using this CD changer, you can play back your original CD-Rs (Recordable) and CD-RWs (Rewritable) recorded either in audio CD format or in MP3 format.

- You can also connect other CH-X series CD changers (except CH-X99 and CH-X100). However, they are not compatible with MP3 discs, so you cannot play back MP3 discs.
- You cannot use the KD-MK series CD changers with this unit.

Before operating your CD changer:

- Refer also to the Instructions supplied for your CD changer.
- If no discs are in the magazine of the CD changer or the discs are inserted upside down, "NO DISC" will appear on the display. If this happens, remove the magazine and set the discs correctly.
- If no magazine is loaded in the CD changer, "NO MAG" appears on the display. If this happens, insert the magazine in the CD changer.
- If "RESET 1" – "RESET 8" appears on the display, something is wrong with the connection between this unit and the CD changer. If this happens, check the connection and make sure the cords are connected firmly. Then, press the reset button of the CD changer.

About MP3 discs

MP3 "files (tracks)" can be recorded in "folders" —in PC terminology.

During recording, the files and folders can be arranged in a way similar to arranging files and folders of computer data.

"Root" is similar to the root of a tree. Every file and folder can be linked to and be accessed from the root.

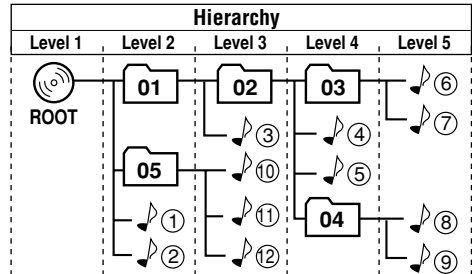

01 : Folders and their playback order

① : MP3 files and their playback order

Playing discs

Select the CD changer (CD-CH).

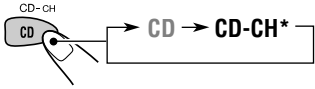

* If you have changed "EXT IN" setting to "LINE IN" (see page 21), you cannot select the CD changer.

- When the current disc is an MP3 disc: Playback starts from the first folder of the current disc once file check is completed.

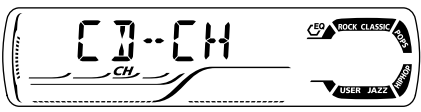

Selected disc number Selected folder number



MP3 indicator Selected track number

Elapsed playing time Current track number

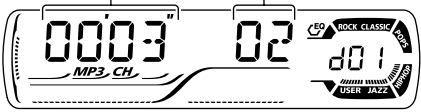

- When the current disc is a CD: Playback starts from the first track of the current disc.

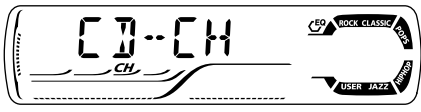

Selected disc number ↓

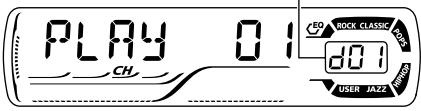

Elapsed playing time Current track number ↓

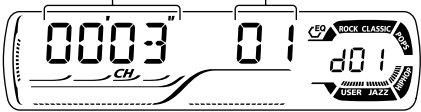

Notes:

- When you press CD CD-CH, the power automatically comes on. You do not have to press /ATT to turn on the power.
- If you change the source, CD changer play also stops. Next time you select the CD changer as the source, CD changer play starts from where playback has been stopped previously.

To go to a particular disc directly

Press the number button corresponding to the disc number to start its playback (while the CD changer is playing).

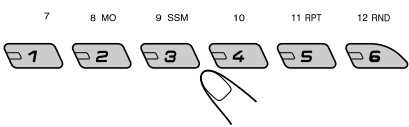

- To select a disc number from 1 – 6: Press 1 (7) – 6 (12) briefly.
- To select a disc number from 7 – 12: Press and hold 1 (7) – 6 (12) for more than one second.

To fast-forward or reverse the track/file



Press and hold **▶▶▶ ▲**, during play, to fast-forward the track/file.

Press and hold **▼ ◀◀◀**, during play, to reverse the track/file.

Note:

During this operation, you can only hear intermittent sounds. (The elapsed playing time also changes intermittently on the display.)

To go to the next or previous tracks/files

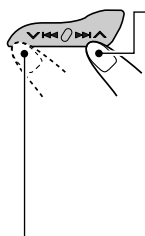

Press **▶▶▶ ▲** briefly during play, to skip ahead to the beginning of the next track/file. Each time you press the button consecutively, the beginning of the next tracks/files is located and played back.

Press **▼ ◀◀◀** briefly during play, to skip back to the beginning of the current track/file. Each time you press the button consecutively, the beginning of the previous tracks/files is located and played back.

This operation is only possible when using JVC MP3-compatible CD changer (CH-X1500).

To go to a track/file quickly (+10 and -10 buttons)

1 Press **MODE** to enter the functions mode while playing a disc.

MODE



2 Press **+10** or **-10**.

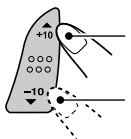

To skip 10 tracks/files* forwards to the last track/file

To skip 10 tracks/files* backwards to the first track/file

* First time you press **+10** or **-10** button, the track/file skips to the nearest higher or lower track/file with a track/file number of multiple ten (ex. 10th, 20th, 30th).

Then each time you press the button, you can skip 10 tracks/files (see "How to use the **+10** and **-10** buttons" below).

• After the last track/file, the first track/file will be selected, and vice versa.

Note:

If the current playing disc is an MP3 disc, files are skipped within the same folder.

How to use the +10 and -10 buttons

• Ex. 1: To select track/file number 32 while playing track/file number 6

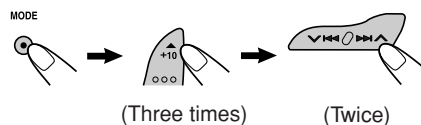

Track/file 6 → 10 → 20 → 30 → 31 → 32

• Ex. 2: To select track/file number 8 while playing track/file number 36

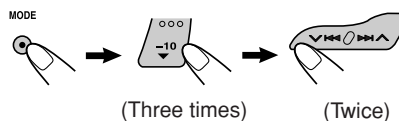

Track/file 36 → 30 → 20 → 10 → 9 → 8

To skip to the next or previous folder (only for MP3 discs)

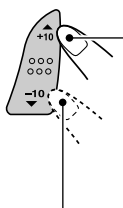

Press **▲** (up) while playing an MP3 disc, to go to the next folder. Each time you press the button consecutively, the next folder is located, and the first file in the folder starts playback.

Press **▼** (down) while playing an MP3 disc, to go to the previous folder. Each time you press the button consecutively, the previous folder is located, and the first file in the folder starts playback.

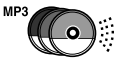

Selecting the playback modes

To play back tracks/files at random (Disc Random/Magazine Random Play)

MODE



1 Press MODE to enter the functions mode during play.

12 RND



2 Press RND (random), while "MODE" is still flashing on the display. Each time you press the button, the random play mode changes as follows:



RND and (disc) indicators

Ex.: When you select "DISC RND"

Note:

MP3 indicator also lights up if the current playing disc is an MP3 disc.

Mode	Active indicator	Plays at random
DISC RND	RND and indicators light up.	All tracks/files of the current (or specified) disc.
MAG RND	RND indicator lights up.	All tracks/files of the inserted discs.

To play back tracks/files repeatedly (Track Repeat/Disc Repeat Play)

MODE



1 Press MODE to enter the functions mode during play.

11 RPT



2 Press RPT (repeat), while "MODE" is still flashing on the display. Each time you press the button, the repeat play mode changes as follows:

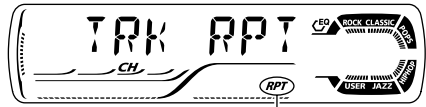

RPT indicator

Ex.: When you select "TRK RPT"

Note:

MP3 indicator also lights up if the current playing disc is an MP3 disc.

Mode	Active indicator	Plays repeatedly
TRK RPT	RPT indicator lights up.	The current (or specified) track/file.
DISC RPT	and RPT indicators light up.	All tracks/files of the current (or specified) disc.

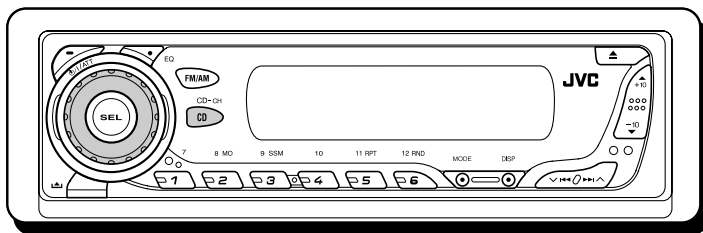

Playing an external component

2 Turn on the connected component and start playing the source.

3 Adjust the volume.

4 Adjust the sound as you want. (See pages 18 and 19.)

You can connect the external component to the CD changer jack on the rear using the Line Input Adapter KS-U57 (not supplied).

Preparations:

- For connecting the Line Input Adapter KS-U57 and the external component, refer to the Installation/Connection Manual (separate volume).
- Before operating the external component using the following procedure, select the external input correctly. See “To select the external component to use—EXT IN” on page 21.

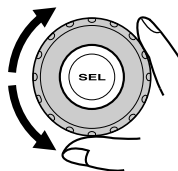

1 Select the external component (LINE IN).



- If “LINE IN”^{*} does not appear on the display, see page 21 and select the external input (“LINE IN”).

^{*} Displayed only when one of the following sources is selected—FM, AM, and CD.

Note on One-Touch Operation:

When you press CD CD-CH, the power automatically comes on. You do not have to press /ATT to turn on the power.



TROUBLESHOOTING

What appears to be trouble is not always serious. Check the following points before calling a service center.

	Symptoms	Causes	Remedies	
General	<ul style="list-style-type: none"> Sound cannot be heard from the speakers. 	The volume level is set to the minimum level.	Adjust it to the optimum level.	
		Connections are incorrect.	Check the cords and connections.	
FM/AM	<ul style="list-style-type: none"> This unit does not work at all. 	Signals are too weak.	Store stations manually.	
		The antenna is not connected firmly.	Connect the antenna firmly.	
CD Playback	<ul style="list-style-type: none"> SSM (Strong-station Sequential Memory) automatic preset does not work. 	Static noise while listening to the radio.	<ul style="list-style-type: none"> The antenna is not connected firmly. 	<ul style="list-style-type: none"> Store stations manually.
	<ul style="list-style-type: none"> CD cannot be played back. 	CD is inserted upside down.	Insert the CD correctly.	
		<ul style="list-style-type: none"> CD-R/CD-RW cannot be played back. Tracks on the CD-R/CD-RW cannot be skipped. 	CD-R/CD-RW is not finalized.	<ul style="list-style-type: none"> Insert a finalized CD-R/CD-RW. Finalize the CD-R/CD-RW with the component which you used for recording.
	<ul style="list-style-type: none"> CD cannot be ejected. 	CD is locked.	Unlock the CD. (See page 17.)	
	<ul style="list-style-type: none"> CD sound is sometimes interrupted. 	You are driving on rough roads.	Stop playback while driving on rough roads.	
		CD is scratched.	Change the CD.	
		Connections are incorrect.	Check the cords and connections.	
<ul style="list-style-type: none"> "NO DISC" appears on the display. 	No CD in the loading slot.	Insert a CD into the loading slot.		
	CD is inserted incorrectly.	Insert the CD correctly.		



Symptoms	Causes	Remedies
<ul style="list-style-type: none"> • “NO DISC” appears on the display. 	No disc is in the magazine.	Insert discs into the magazine.
	Discs are inserted upside down.	Insert discs correctly.
<ul style="list-style-type: none"> • “NO MAG” appears on the display. 	No magazine is loaded in the CD changer.	Insert the magazine.
<ul style="list-style-type: none"> • “RESET 8” appears on the display. 	This unit is not connected to the CD changer correctly.	Connect this unit and the CD changer correctly and press the reset button of the CD changer.
<ul style="list-style-type: none"> • “RESET 1” – “RESET 7” appears on the display. 	_____	Press the reset button of the CD changer.
<ul style="list-style-type: none"> • The CD changer does not work at all. 	The built-in microcomputer may function incorrectly due to noise, etc.	Press the reset button on the panel holder after detaching the control panel. (The clock setting and preset stations stored in memory are erased.) (See page 2.)

CD Changer

About mistracking:

Mistracking may result from driving on extremely rough roads. This does not damage the unit and the disc, but will be annoying.

We recommend that you stop disc play while driving on such rough roads.



MAINTENANCE

Handling discs

This unit has been designed to reproduce CDs, CD-Rs (Recordable), and CD-RWs (Rewritable).

- **This unit is not compatible with MP3 discs,** but can operate a JVC MP3-compatible CD changer.

How to handle discs

When removing a disc from its case,

press down the center holder of the case and lift the disc out, holding it by the edges.

- Always hold the disc by the edges. Do not touch its recording surface.

Center holder



When storing a disc into its case, gently insert the disc around the center holder (with the printed surface facing up).

- Make sure to store discs into the cases after use.

To keep discs clean

A dirty disc may not be played correctly. If a disc does become dirty, wipe it with a soft cloth in a straight line from center to edge.



To play new discs

New discs may have some rough spots around the inner and outer edges. If such a disc is used, this unit may reject the disc.

To remove these rough spots, rub the edges with a pencil or ball-point pen, etc.



Moisture condensation

Moisture may condense on the lens inside the CD player in the following cases:

- After starting the heater in the car.
- If it becomes very humid inside the car.

Should this occur, the CD player may malfunction. In this case, eject the disc and leave the unit turned on for a few hours until the moisture evaporates.

When playing a CD-R or CD-RW

Before playing back CD-Rs or CD-RWs, read their instructions or cautions carefully.

- Use only "finalized" CD-Rs or CD-RWs.
- Some CD-Rs or CD-RWs may not be played back on this unit because of their disc characteristics, and for the following reasons:
 - Discs are dirty or scratched.
 - Moisture condensation on the lens inside the unit.
 - The pickup lens inside the unit is dirty.
- CD-RWs may require a longer readout time since the reflectance of CD-RWs is lower than that of regular CDs.
- CD-Rs or CD-RWs are susceptible to high temperatures or high humidity, so do not leave them inside your car.
- Do not use following CD-Rs or CD-RWs:
 - Discs with stickers, labels, or protective seal stuck to the surface.
 - Discs on which labels can be directly printed by an ink jet printer.

Using these discs under high temperatures or high humidity may cause malfunctions or damage to discs. For example,

- Stickers or labels may shrink and warp a disc.
- Stickers or labels may be peeled off so discs cannot be ejected.
- Print on discs may get sticky.

Read instructions or cautions about labels and printable discs carefully.

CAUTIONS:

- Do not insert 8 cm discs (single CDs) into the loading slot. (Such discs cannot be ejected.)
- Do not insert any disc of unusual shape—like a heart or flower; otherwise, it will cause a malfunction.
- Do not expose discs to direct sunlight or any heat source or place them in a place subject to high temperature and humidity. Do not leave them in a car.
- Do not use any solvent (for example, conventional record cleaner, spray, thinner, benzene, etc.) to clean discs.

Warped disc



Sticker



Sticker residue

Disc



Stick-on label

AUDIO AMPLIFIER SECTION

Maximum Power Output:

Front: 50 W per channel

Rear: 50 W per channel

Continuous Power Output (RMS):

Front: 19 W per channel into 4 Ω , 40 Hz to 20 000 Hz at no more than 0.8% total harmonic distortion.

Rear: 19 W per channel into 4 Ω , 40 Hz to 20 000 Hz at no more than 0.8% total harmonic distortion.

Load Impedance: 4 Ω (4 Ω to 8 Ω allowance)

Tone Control Range

Bass: ± 10 dB at 100 Hz

Treble: ± 10 dB at 10 kHz

Frequency Response: 40 Hz to 20 000 Hz

Signal-to-Noise Ratio: 70 dB

Line-Out Level/Impedance:

2.0 V/20 k Ω load (full scale)

Output Impedance: 1 k Ω

TUNER SECTION

Frequency Range

FM: 87.5 MHz to 108.0 MHz

AM: 531 kHz to 1 602 kHz

[FM Tuner]

Usable Sensitivity: 11.3 dBf (1.0 μ V/75 Ω)

50 dB Quieting Sensitivity:

16.3 dBf (1.8 μ V/75 Ω)

Alternate Channel Selectivity (400 kHz):

65 dB

Frequency Response: 40 Hz to 15 000 Hz

Stereo Separation: 35 dB

Capture Ratio: 1.5 dB

[AM Tuner]

Sensitivity: 20 μ V

Selectivity: 35 dB

CD PLAYER SECTION

Type: Compact disc player

Signal Detection System: Non-contact optical pickup (semiconductor laser)

Number of channels: 2 channels (stereo)

Frequency Response: 5 Hz to 20 000 Hz

Dynamic Range: 96 dB

Signal-to-Noise Ratio: 98 dB

Wow and Flutter: Less than measurable limit

GENERAL

Power Requirement

Operating Voltage:

DC 14.4 V (11 V to 16 V allowance)

Grounding System: Negative ground

Allowable Operating Temperature:

0°C to +40°C

Dimensions (W \times H \times D):

Installation Size (approx.):

182 mm \times 52 mm \times 150 mm

Panel Size (approx.):

188 mm \times 58 mm \times 12 mm

Mass (approx.):

1.4 kg (excluding accessories)

Design and specifications are subject to change without notice.

**Having TROUBLE with operation?
Please reset your unit
Refer to page of How to reset your unit**

JVC

KD-G305

راديو مع مشغل CD

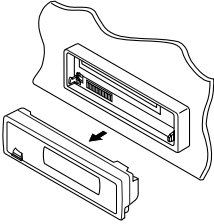
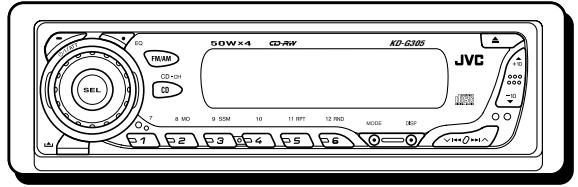
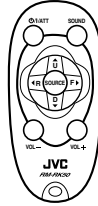

CD-RW **COMPACT**
disc
DIGITAL AUDIO

• هذا الجهاز مزود بوظيفة استعراض لشاشة العرض. لالغاء وظيفة الاستعراض، انظر صفحة ٨.

لعمليات التركيب والتوصيلات، يرجى مراجعة كتيب التعليمات المنفصل.

كتيب التعليمات



EN, CT, TH, AR
© 2003 VICTOR COMPANY OF JAPAN, LIMITED

1003KKSMJDTEIN

JVC KD-G305

Installation/Connection Manual

安裝／連接手冊

การติดตั้ง/คู่มือการติดตั้ง

كتيب تعليمات التركيب/التوصيل

GET0181-003A
[U]

1003KKSMDTJEIN
EN, CT, TH, AR

ENGLISH

中文

ไทย

عربي

This unit is designed to operate on **12 V DC, NEGATIVE ground electrical systems**. If your vehicle does not have this system, a voltage inverter is required, which can be purchased at JVC car audio dealers.

本機僅可使用直流 12V、負極接地的電源系統。如果您的車輛沒有這一電源系統，則需要一個電壓變換器，可以在 JVC 汽車音響分銷商處買到。

ชุดประกอบนี้ได้รับการออกแบบมาเพื่อใช้งานกับระบบกระแสไฟฟ้าสายดินขั้วลบกระแสตรง 12 โวลท์ หากรถยนต์ของคุณไม่ได้อาศัยระบบนี้ ต้องใช้เครื่องแปลงกระแสไฟด้วย ซึ่งสามารถหาซื้อได้จากร้านขายเครื่องเสียงรถยนต์ JVC

لقد صمم هذا الجهاز ليعمل فقط بواسطة تيار كهربائي مباشر DC، ١٢ فولت، انظمة كهربائية تاريض سالب. في حالة عدم وجود مثل هذا النظام في سيارتك، يجب استخدام محول فولتا، ويمكن شراء هذا المحول من وكلاء الاجهزة الصوتية للسيارات ماركة JVC.

Parts list for installation and connection

The following parts are provided for this unit. After checking them, please set them correctly.

用於安裝和連接的零件裏下列零件是隨本機提供的。清點以後，正確的將其裝配。

รายการส่วนประกอบสำหรับติดตั้งและเชื่อมต่อกัน ส่วนประกอบต่อไปนี้ให้มาพร้อมกับชุดประกอบนี้ หลังจากตรวจสอบแล้ว โปรดตั้งเครื่องให้ถูกต้อง

قائمة اجزاء التركيب والتوصيل الاجزاء التالية مزودة مع الجهاز. بعد فحص هذه الاجزاء، يرجى تركيبهم بشكل صحيح.

A / B
Hard case/Control panel
硬盒 / 控制面板
กล่องบรรจุ/หน้าปัด
صندوق صلب/لوحة التحكم

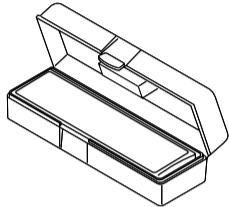

C
Sleeve
外套機殼
ปลอกหุ้ม
الهيكال الواقعي

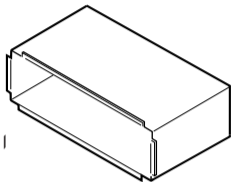

D
Trim plate
裝飾框
แผ่นโลหะขอบแต่ง
لوحة الزينة

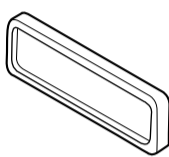

E
Power cord
電路連接用的配線束
สายเคเบิลกำลัง
سلك الطاقة
الكهربائية

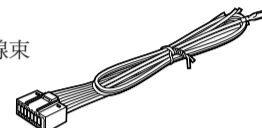

F
Remote controller
遙控器
ريموتคอนโทรل
وحدة التحكم عن بعد

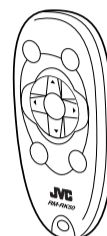

G
Washer (ø5)
墊圈 (ø5)
ประเก็นวงแหวน (ø5)
حلقة احكام التوصيل (قطر ٥)



H
Lock nut (M5)
鎖定螺母 (M5)
นอตล็อค (M5)
صمولة التثبيت (M5)



I
Mounting bolt (M5 x 20 mm)
緊固螺栓 (M5 x 20 mm)
สลักติด (M5 x 20 มิลลิเมตร)
مسام التركيب (٢٠ x M5 ملم)



J
Rubber cushion
橡膠防震墊
ยางกันกระแทก
الحشية المطاطية



K
Handles
板條型把手
กันบั้งกับ
المساکت



L
Battery
電池
แบตเตอรี่
البطاريات
CR2025



INSTALLATION (IN-DASH MOUNTING)

安裝（裝設、固定在儀表板內）

การติดตั้ง (การประกอบแผงหน้าปัดหน้า)

تركيب الجهاز (داخل - تابلو السيارة)

The following illustration shows a typical installation. If you have any questions or require information regarding installation kits, consult your JVC car audio dealer or a company supplying kits.

下面的圖解表示了典型的安裝程序。如果您有問題，或需要有關配套元件的資料，請向 JVC 汽車音響分銷商或配套元件供應公司詢問。

ภาพตัวอย่างต่อไปนี้แสดงถึงการติดตั้งแบบทั่วไป หากคุณมีปัญหาคือต้องการข้อมูลเกี่ยวกับชุดติดตั้ง กรุณาปรึกษากับผู้เชี่ยวชาญหรือตัวแทน JVC ของท่านหรือบริษัทผู้ขายเครื่องเสียงรถยนต์ JVC ของท่านหรือบริษัท

يبين الرسم التوضيحي التالي طريقة التركيب المثالية. اذا كان هناك استفسارات او حاجة لمعلومات بخصوص ادوات التركيب، يرجى استشارة موزع الاجهزة الصوتية للسيارات ماركة JVC او الشركة الموزعة لهذه الادوات. في حالة عدم معرفتك بكيفية تركيب الجهاز بشكل صحيح، يرجى ترك العملية تركيب الجهاز لشخص مختص ومؤهل لتركيب مثل هذه الاجهزة.

- If you are not sure how to install this unit correctly, have it installed by a qualified technician.

- 如果您不能確定如何正確地安裝本機，應請合格的技術人員來安裝。

1

2

3

*1 When you stand the unit, be careful not to damage the fuse on the rear.
*1 您豎起本機時，小心不要損壞底部的保險絲。
*1 เมื่อคุณตั้งชุดประกอบขึ้น ระวังงอขาทำให้ฟิวส์บริเวณส่วนท้ายเสียหาย

*2 عند توقيف الجهاز، انتبه من اجل عدم تضرر الفيوز الموجود على الجهة الخلفية.

4

Do the required electrical connections.
進行所需的電路連接。
ต่อสายไฟตามที่กำหนดไว้ทั้งหมด
اعمل التوصيلات الكهربائية المطلوبة.

Bend the appropriate tabs to hold the sleeve firmly in place.
弄彎機殼的突舌，把外套機殼牢固在儀表板內。
งอแผ่นเพื่อยึดปลอกให้ตอกันเข้าที่
انثى اللسنة بشكل مناسب لتثبيت الهيكال الواقعي بشكل محكم في المكان الصحيح.

Removing the unit

Before removing the unit, release the rear section.

拆卸本機

在拆卸本機前，應將本機後部的固定和連接部分鬆開。

การถอดชุดประกอบ

ก่อนจะถอดชุดประกอบ ให้ปลดหน้าตัดส่วนท้ายก่อน

نزع الجهاز من تابلو السيارة

قبل نزع الجهاز، حرر الجزء الخلفي.

1

2

3

Insert the two handles, then pull them as illustrated so that the unit can be removed.
按圖所示，將兩片板條型把手插入卡槽，然後輕穩地從兩側向外拉兩片把手，本機隨之拉出。
ใส่คั่นบั้งกับ 2 อันลงในร่องสำหรับไขที่ด้านหลังภาพ จากนั้น ให้เลื่อนชุดประกอบออกในขณะที่ค่อย ๆ ดึงคั่นบั้งกับทั้งสอง อันออกจากกัน
ادخل المساکتین، وبعد ذلك اسحبهم كما هو مبين بحيث يمكن نزع الجهاز.

When using the optional stay / 若選用支撐架 /
เมื่อใช้ตัวยึดแบบเลือกได้ (สามารถเลือกเปิดค้างไว้ได้) /
عند استخدام الدعامة الاضافية

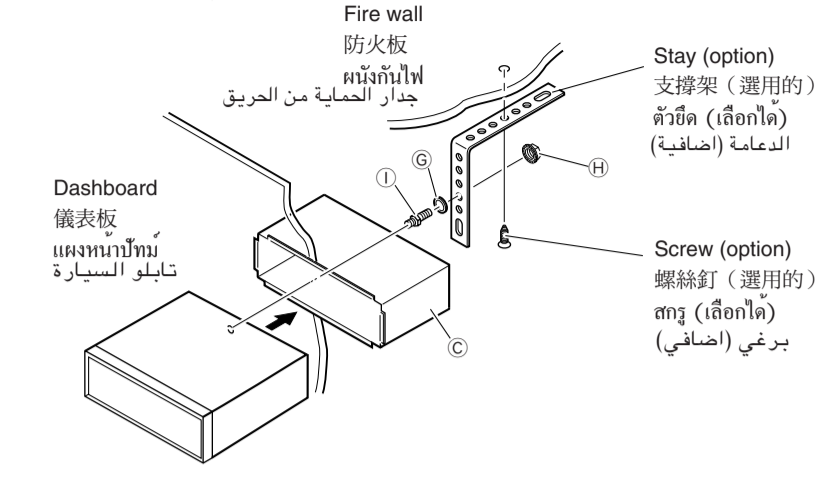

Install the unit at an angle of less than 30°. **將本機安裝在少於 30° 的角度。**
 ติดตั้งชุดประกอบที่มุมต่ำกว่า 30 องศา **ركب الجهاز على زاوية اقل من 30 درجة.**

When installing the unit without using the sleeve / 若不使用外套機殼安裝本機 /
เมื่อติดตั้งชุดประกอบโดยไม่ใช้ปลอกหุ้ม / استخدام الهيكل الواسي بدون تركيب الجهاز بدون استخدام الهيكل الواسي

In a Toyota for example, first remove the car radio and install the unit in its place. **以豐田牌 (TOYOTA) 汽車為例：首先取出汽車收音機，然後將本機裝入其空出的位置。**
 ตัวอย่างเช่น ในรถยนต์โตโยต้า ให้ถอดวิทยุติดรถยนต์ออกก่อนและติดตั้งชุดประกอบนี้เข้าไปแทน **على سبيل المثال، في سيارات نوع تويوتا، انزع راديو السيارة اولا بعد ذلك ركب الجهاز في مكانه.**

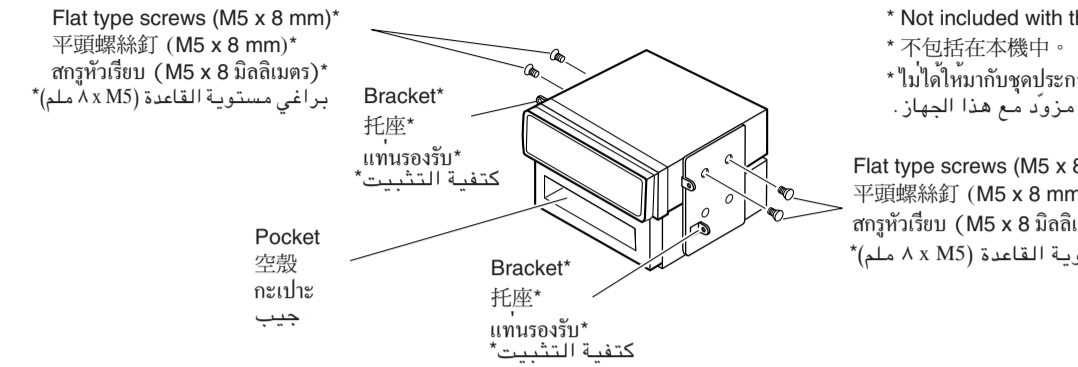

Note : When installing the unit on the mounting bracket, make sure to use the 8 mm-long screws. If longer screws are used, they could damage the unit. **注意** : 把本機安裝在托座上時，務必使用 8 mm 長的螺絲釘。如使用過長的螺絲釘，會損壞本機。
หมายเหตุ : เมื่อติดตั้งชุดประกอบลงในแท่นรองรับไว้ ให้ใช้สกรูยาวขนาด 8 มิลลิเมตร ถ้าใช้สกรูยาวกว่านี้อาจทำให้ชุดประกอบเสียหายได้ **ملاحظة** : عند تركيب الجهاز على كتفيات التثبيت، تأكد من استعمال براغي طول 8 ملم. في حالة استخدام براغي اطول من 8 ملم، يمكن ان يسبب ذلك تلف او ضرر للجهاز.

ELECTRICAL CONNECTIONS

To prevent short circuits, we recommend that you disconnect the battery's negative terminal and make all electrical connections before installing the unit.
Be sure to ground this unit to the car's chassis again after installation.

- Notes:**
- Replace the fuse with one of the specified rating. If the fuse blows frequently, consult your JVC car audio dealer.
 - It is recommended to connect to the speakers with maximum power of more than 50 W (both at the rear and at the front, with an impedance of 4 Ω to 8 Ω). If the maximum power is less than 50 W, change "AMP GAIN" setting to prevent the speakers from being damaged (see page 21 of the INSTRUCTIONS).
 - To prevent short-circuit, cover the terminals of the UNUSED leads with insulating tape.
 - The heat sink becomes very hot after use. Be careful not to touch it when removing this unit.



電路連接

為防止短路，建議在安裝本機之前，斷開電池的負極，並把所有電路都連接好。
 • 安裝完畢後務必將本機的地線重新接至車身。

- 注意：**
- 把保險絲更換為額定負荷值的保險絲。如果保險絲經常燒壞，請向 JVC 汽車音響分銷商詢問。
 - 後置和前置揚聲器的最大輸入功率應大於 50 W，其阻抗為 4 Ω – 8 Ω。如果最大功率小於 50 W，請調校 "AMP GAIN" 設定值，以防止揚聲器損壞。(參閱使用說明書的第 21 頁)。
 - 為防止電源短路，請用絕緣膠帶包住未使用電線的端子。
 - 本機使用後，散熱片會很熱。因此，在移出本機時，小心不要觸摸散熱片。

การเชื่อมโดยใช้ไฟฟ้า

เพื่อป้องกันการเกิดไฟฟ้าลัดวงจรขอแนะนำให้ปลดขั้วแบตเตอรี่ลบออก แล้วจึงต่อสายไฟก่อนติดตั้งเครื่อง
 • ตรวจสอบให้แน่ใจว่าได้เดินสายดินต่อระหว่างเครื่องกับตัวถังรถยนต์ใหม่แล้วหลังจากติดตั้ง

- หมายเหตุ :**
- ใช้ฟิวส์ที่เฉพาะแทนฟิวส์ หากฟิวส์ขาดบ่อย ให้ปรึกษาช่างขายเครื่องเสียงรถยนต์ JVC
 - ขอแนะนำให้ต่อลำโพง ที่มีกำลังขับสูงสุดเกินกว่า 50 W (ทั้งด้านหน้าและด้านหลัง มีค่าความต้านทาน 4 Ω ถึง 8 Ω) ถ้ากำลังขับต่ำกว่า 50 W ให้เปลี่ยนค่า "AMP GAIN" เพื่อป้องกันไม่ให้ลำโพงชำรุด (ดูหน้า 21 ในคู่มือใช้งาน)
 - การป้องกันกรัดวงจร จะต้องพันขั้วสายตะกั่วที่ไม่ใช่แล้วด้วยเทปพันสายไฟ
 - แผ่นระบายความร้อนจะร้อนมากหลังจากใช้ ระวังอย่าไปสัมผัสเมื่อถอดชุดประกอบนี้

التوصيلات الكهربائية

لمنع حدوث تقصير في الدوائر الكهربائية، نوصي بفصل طرف توصيل البطارية السالبة وعمل كل التوصيلات الكهربائية قبل تركيب الجهاز.
 • تأكد من تأريض الجهاز مع هيكل السيارة مرة ثانية بعد التركيب.

- ملاحظات:**
- ستبدل الفيوز بفيوز آخر يحمل نفس القياسات الموصوفة. إذا تكرر احتراق الفيوز، استشر وكيل JVC لأجهزة السيارة الصوتية.
 - ينصح التوصيل مع سماعات ذات طاقة قصوى أكثر من 50 واط (على كلا من الخلف والامام، مع ممانعة 4 اوم الى 8 اوم). إذا كانت الطاقة القصوى اقل من 50 واط، غير وضع تهيئة "AMP GAIN" لمنع السماعات من الضرر. (انظر صفحة 21 من كتيب التعليمات).
 - من أجل منع تقصير الدائرة الكهربائية، ضع شريط لاصق على اطراف الاسلاك غير المستعملة.
 - تصبح صفيحة خفض الحرارة ساخنة جدا بعد الاستخدام. تأكد من عدم ملامستها عند نزع الجهاز.

PRECAUTIONS on power supply and speaker connections:

- DO NOT connect the speaker leads of the power cord to the car battery; otherwise, the unit will be seriously damaged.**
- BEFORE connecting the speaker leads of the power cord to the speakers, check the speaker wiring in your car.**

電源和揚聲器接線注意事項：

- 切勿把揚聲器導線接頭接至電池，否則本機將會嚴重損壞。
- 在把揚聲器導線接頭接至揚聲器之前，檢查您汽車上的揚聲器線路。

ข้อควรระวังสำหรับการต่อแหล่งจ่ายกำลังและลำโพง:

- อย่าต่อสายตะกั่วเคเบิลกำลังของลำโพงเข้ากับแบตเตอรี่รถยนต์ มิฉะนั้นชุดประกอบจะได้รับความเสียหายมาก
- ก่อนที่จะต่อสายตะกั่วเคเบิลกำลังของลำโพงเข้ากับลำโพง ให้ตรวจสอบการเดินสายไฟลำโพงในรถของคุณให้เรียบร้อยเสียก่อน

تنبيهات حول تزويد الطاقة الكهربائية وتوصيل السماعات:

- لا توصل اسلاك تزويد طاقة السماعات مع بطارية السيارة، لان ذلك يؤدي الى حصول ضرر للسماعات.**
- قبل توصيل اسلاك تزويد طاقة السماعات مع السماعات، افحص شبكة اسلاك السماعات داخل سيارتك.**



TROUBLESHOOTING

- The fuse blows.**
 * Are the red and black leads connected correctly?
- Power cannot be turned on.**
 * Is the yellow lead connected?
- No sound from the speakers.**
 * Is the speaker output lead short-circuited?
- Sound is distorted.**
 * Is the speaker output lead grounded?
 * Are the "-" terminals of L and R speakers grounded in common?
- Noise interfere with sounds.**
 * Is the rear ground terminal connected to the car's chassis using shorter and thicker cords?
- Unit becomes hot.**
 * Is the speaker output lead grounded?
 * Are the "-" terminals of L and R speakers grounded in common?

故障排除

- 保險絲燒斷。
 * 檢查紅色導線接頭和黑色導線接頭是否接觸正確？
- 電源不能接通。
 * 檢查黃色導線接頭是否接上？
- 揚聲器沒有聲音。
 * 檢查揚聲器輸出導線接頭是否短路？
- 聲音失真。
 * 檢查揚聲器輸出端子是否接地？
 * 檢查揚聲器的左 (L)、右 (R) 端子的負極 (-) 是否共同接地？
- 噪音干擾音響。
 * 後接地端子與車身是否使用較短和較厚的電線連接？
- 本機發熱。
 * 檢查揚聲器輸出端子是否接地？
 * 檢查揚聲器的左 (L)、右 (R) 端子的負極 (-) 是否共同接地？

การตรวจสอบปัญหาขัดข้อง

- ฟิวส์ขาด**
 * มีการเชื่อมสายตะกั่วสีดำนและสีแดงอย่างถูกต้องหรือไม่
- ไม่สามารถเปิดเครื่องได้**
 * มีการเชื่อมสายตะกั่วสีเหลืองหรือไม่
- ไม่มีเสียงออกจากลำโพง**
 * สายตะกั่วส่วนที่ออกทางลำโพงเกิดไฟฟ้าลัดวงจรหรือไม่
- เสียงเพี้ยน**
 * สายตะกั่วส่วนที่ออกทางลำโพงตลงดินหรือไม่
 * สายขั้วลบ ของลำโพงด้านซ้ายและขวาตลงดินตามปกติหรือไม่
- เสียงรบกวน**
 * มีการใช้สายสั้นๆ หรือหนาๆ ต่อจากเครื่องส่วนที่ติดตั้งไว้บนพื้นด้านหลังกับตัวถังรถยนต์หรือไม่
- ชุดประกอบร้อนขึ้น**
 * สายตะกั่วส่วนที่ออกทางลำโพงตลงดินหรือไม่
 * สายขั้วลบ ของลำโพงด้านซ้ายและขวาตลงดินตามปกติหรือไม่

البحث عن الاعطال والاصلاح

- يحترق الفيوز.**
 * هل السلك الاحمر والاسود موصولة بشكل صحيح؟
- لا يمكن توصيل الطاقة الكهربائية.**
 * هل السلك الاصفر موصولاً؟
- لا يصدر صوت من السماعات.**
 * هل هنالك تقصير في دائرة سلك خرج السماعة؟
- الصوت مشوه.**
 * هل سلك خرج السماعة موصولاً بالارض؟
 * هل الاطراف السالبة "-" للسماعة اليسرى L واليمنى R موصولة بالارض مع بعض؟
- تداخل ضجيج مع الاصوات.**
 * هل طرف الارضي الخلفي موصول مع هيكل السيارة باستعمال اسلاك اقصر واسمك؟
- يسخن الجهاز.**
 * هل سلك خرج السماعة موصولاً بالارض؟
 * هل الاطراف السالبة "-" للسماعة اليسرى L واليمنى R موصولة بالارض مع بعض؟

A Typical Connections / 典型的接線方法 / การเชื่อมต่อแบบปกติ / التوصيلات النموذجية

Before connecting: Check the wiring in the vehicle carefully. Incorrect connection may cause serious damage to this unit. The leads of the power cord and those of the connector from the car body may be different in color.

接線前: 仔細檢查汽車內的線路。不正確的接線會導致本機嚴重損壞。電力線的引線和車身的連接器引線在顏色上可能有所不同。

ก่อนทำการเชื่อมต่อ: ตรวจสอบการเดินสายไฟในรถยนต์อย่างระมัดระวัง การเชื่อมต่อที่ไม่ถูกต้องอาจทำให้เกิดความเสียหายร้ายแรงแก่ชุดอุปกรณ์ได้ สายไฟและสายเชื่อมต่อจากตัวรถอาจมีสีที่แตกต่าง

قبل البدء بالتوصيل: تأكد من شبكة الاسلاك في السيارة بدقة حتى لا يحدث خطأ في عملية توصيل الجهاز. يمكن ان يسبب التوصيل الخاطئ الى حصول عطل حقيقي للجهاز. يمكن ان يختلف لون سلك الطاقة الكهربائية وسلك الموصل عن لون هيكل السيارة.

- 1 Connect the colored leads of the power cord in the order specified in the illustration below.
- 2 Connect the antenna cord.
- 3 Finally connect the wiring harness to the unit.

- 1 依照下圖所示之次序連接電源線的顏色導線。
- 2 將天線的電線連接起來。
- 3 最後，把配線束的插頭插在本機上。

- 1 ต่อสายไฟสีตามลำดับที่ระบุในรูปด้านล่าง
- 2 เชื่อมต่อกับสายอากาศ
- 3 สุดท้าย ต่อส่วนควบคุมการเดินสายไฟเข้ากับชุดประกอบชุดนี้

- 1 اوصل الاسلاك الملونة لسلك الطاقة الكهربائية بالترتيب الموصوف في الرسم الموجود في الاسفل.
- 2 اوصل سلك الهوائي.
- 3 اخيرا، اوصل حامل الاسلاك مع الجهاز.

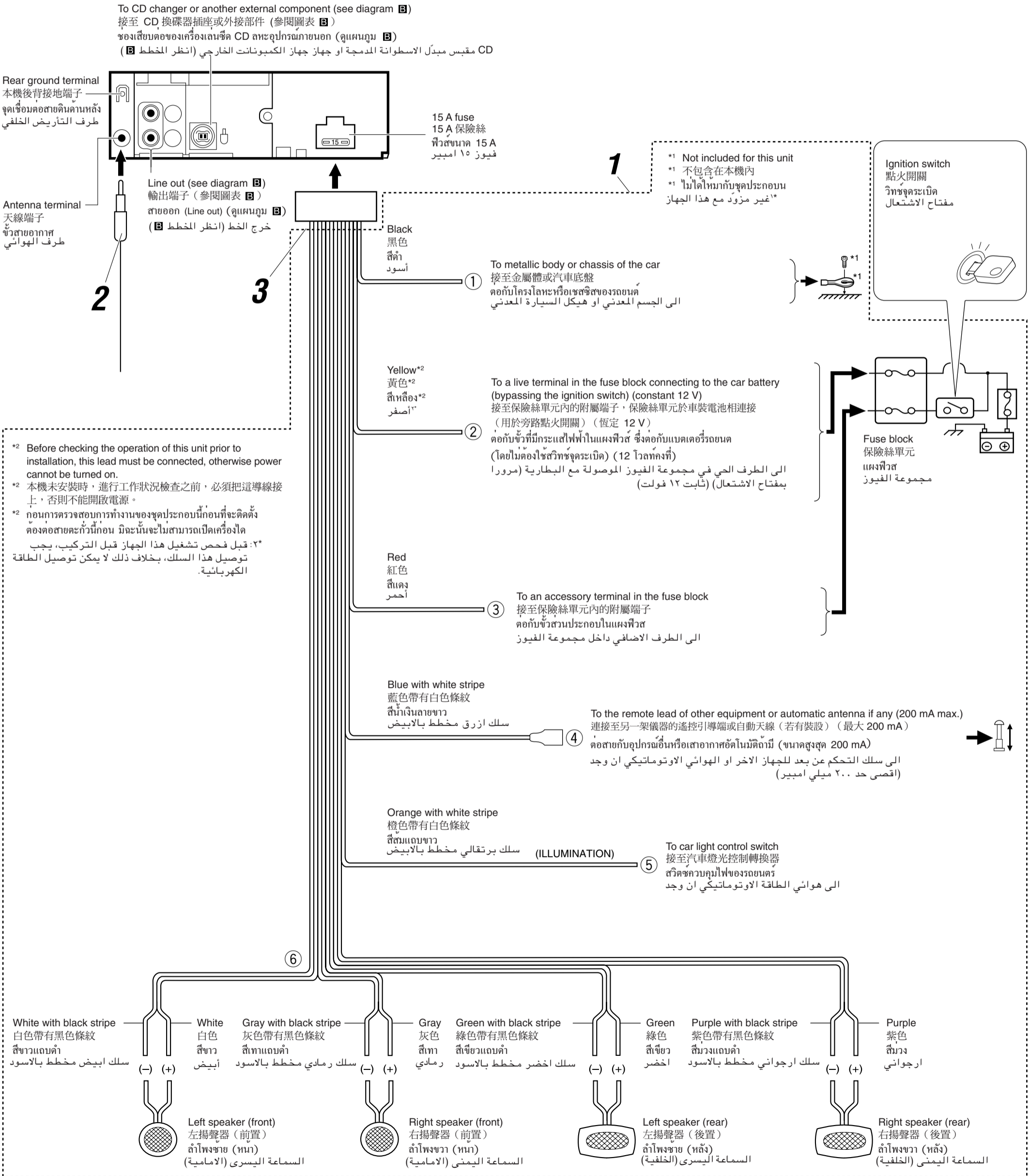

B Connections Adding Other Equipment / 連接附加的其他音響設備 / การต่อเพิ่มเติมเข้ากับอุปกรณ์อื่น ๆ / توصيل الاجهزة الاخرى الاضافية

Amplifier / 功率放大器 / เครื่องขยาย / مضخم الصوت

You can connect an amplifier and other equipment to upgrade your car stereo system.

- Connect the remote lead (blue with white stripe) to the remote lead of the other equipment so that it can be controlled through this unit.
- **For amplifier only:**
Disconnect the speakers from this unit, connect them to the amplifier. Leave the speaker leads of this unit unused.

您可以連接擴音器和其他裝置以提昇專車的音響系統。

- 將遙控引導端（藍色帶有白色條紋）和其他裝置上的遙控引導端連接起來，以便可以通過本機進行遙控。
- 僅適用於放大器：
將揚聲器和本機斷開，再連接上放大器。將本機的揚聲器接線放置不用。

คุณสามารถต่อกับแอมพลิฟายเออร์ และอุปกรณ์อื่น ๆ ได้ เพื่อเพิ่มคุณภาพเสียงให้กับระบบสเตอริโอของรถยนต์

- ต่อสายตัวกระยะไกล (สีน้ำเงินลายขาว) เข้ากับสายตัวกระยะไกลของอุปกรณ์อื่น ๆ เพื่อจะสามารถควบคุมโดยชุดประกอบนี้ได้
- สำหรับเครื่องขยายเท่านั้น :
ถอดลำโพงออกจากชุดประกอบนี้ แล้วต่อเข้ากับเครื่องขยาย ทั้งสายตัวลำโพงของชุดประกอบนี้ไว้

يمكنك توصيل مضخم صوت او اجهزة اخرى لتحسين اداء جهاز ستيريو السيارة.

- اوصل سلك التحكم عن بعد (الازرق المخطط بالابيض) مع سلك التحكم عن بعد للجهاز الاخر بحيث يتم التحكم بالجهاز من خلال هذا الجهاز.
- فقط لمضخم الصوت:
افصل السماعات من هذا الجهاز، اوصلهم مع مضخم الصوت. اترك اسلاك سماعات هذا الجهاز بدون استعمال.

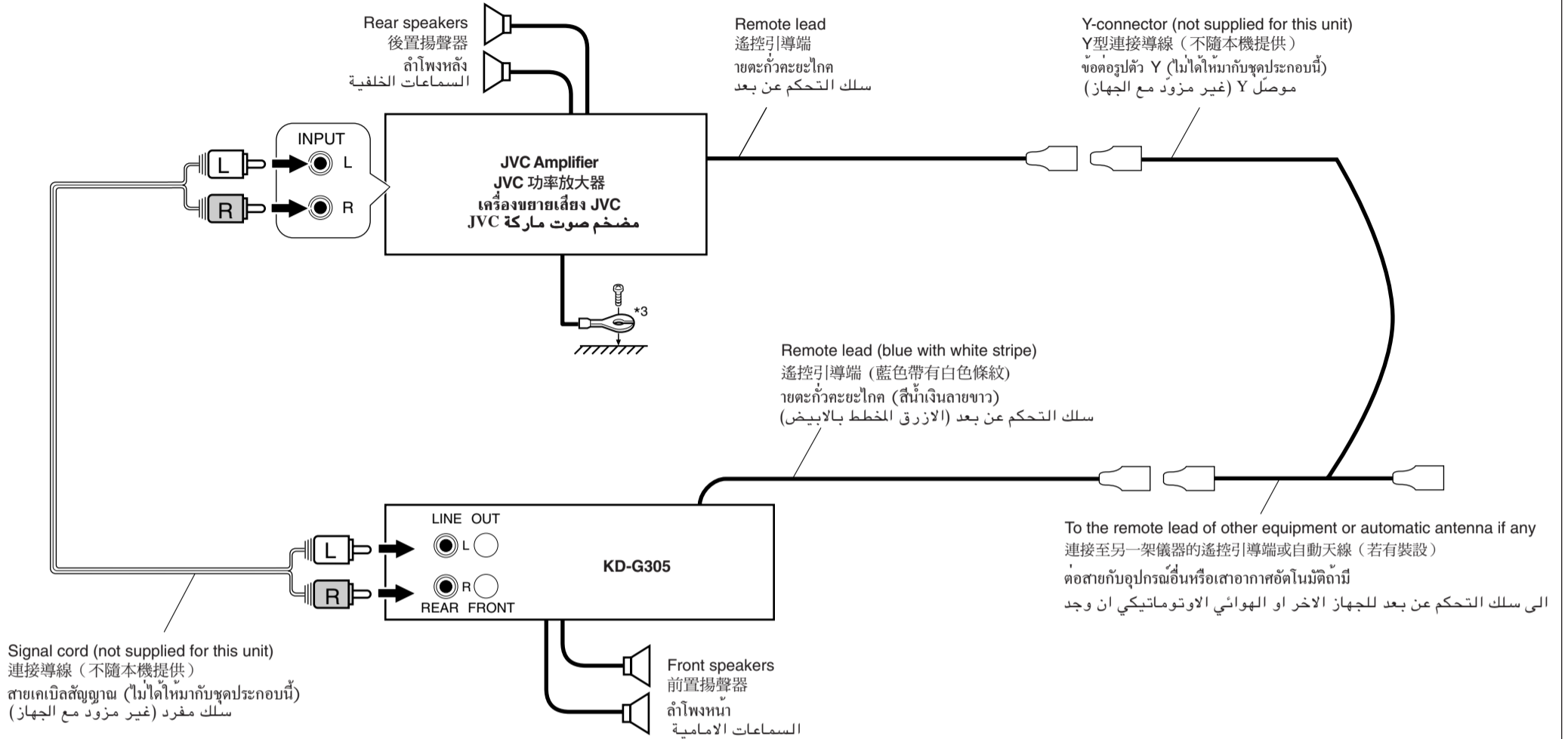

*3 Firmly attach the ground wire to the metallic body or to the chassis of the car—to the place not coated with paint (if coated with paint, remove the paint before attaching the wire). Failure to do so may cause damage to the unit.

*3 將地線與金屬車體或者汽車底盤緊密連接，連接處應該沒有被油漆覆蓋（如果已塗上油漆，在連接電線前，將油漆刮去）。如果不這樣做，可能會損壞本機。

*3 ต่อลวดสายดินให้แน่นเข้ากับตัวถังเหล็ก หรือตัวถังรถ — ตรงส่วน ที่ไม่มีสีเคลือบ (หากมีสีเคลือบอยู่ ให้ขูดสีออกก่อนก่อนต่อลวดสายดิน) หากไม่ปฏิบัติตามคำแนะนำนี้ เครื่องอาจชำรุดหรือเสียหายได้

*3: اوصل السلك الارضي بشكل محكم مع هيكل او جسم السيارة المعدني - مع الموضع غير المطلي بالدهان (اذا كان الموضع مطلي بالدهان، ازل الدهان قبل توصيل السلك). في حالة توصيل السلك مع الهيكل دون ازالة الدهان يمكن ان يسبب ذلك ضرر لهذا الجهاز.

CD Changer / CD 換碟器 / เครื่องเล่นซีดี CD / مبدل الاسطوانة المدمجة

Refer also to page 23 of the INSTRUCTIONS.

同時參閱使用說明書的第 23 頁。
ดูข้อแนะนำในหน้า 23
راجع أيضاً صفحة 23 من كتيب التعليمات.

Connecting cord supplied for your CD changer
連接所提供的電線至您的 CD 換碟器
สายต่อให้มาพร้อมเครื่องเล่นซีดี
توصيل السلك المزود لمبدل الاسطوانة المدمجة

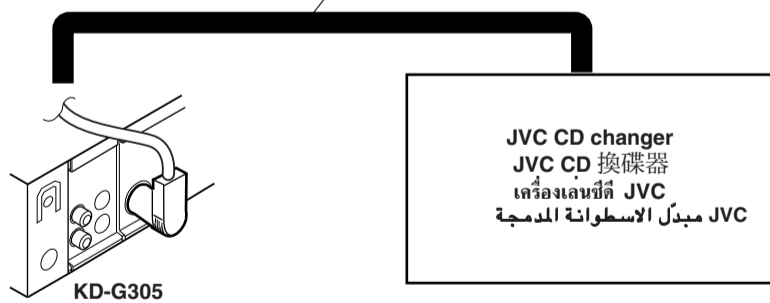

CAUTION / 注意 / ข้อควรระวัง / تنبيه

- Before connecting the CD changer, make sure that the unit is turned off.
- 連接 CD 轉換器之前，應先將本機關閉。
- ก่อนจะเชื่อมต่อเครื่องเล่นซีดี กรุณาตรวจสอบให้แน่ใจว่าเครื่องเล่นซีดีนั้นปิดอยู่
- قبل توصيل مبدل الاسطوانة المدمجة، تأكد من ايقاف الوحدة عن التشغيل.

External Component / 外接部件 / อุปกรณ์ภายนอก / جهاز الكمبيوتر الخارجي

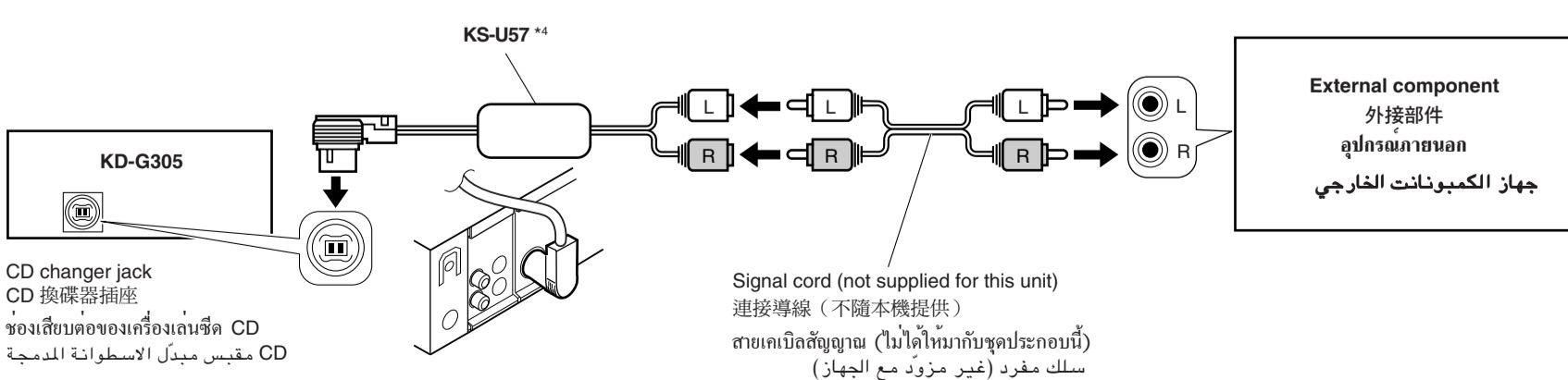

*4 Line Input Adapter KS-U57 (not supplied for this unit)
線輸入適配器KS-U57 (不隨本機提供)
*4 อแดปเตอร์สายสัญญาณเข้า KS-U57 (ไม่ได้ให้มากับชุดประกอบนี้)
*4 *4 เม้าท์, دخل الخط KS-U57 (غير مزود مع هذا الجهاز)

Free Manuals Download Website

<http://myh66.com>

<http://usermanuals.us>

<http://www.somanuals.com>

<http://www.4manuals.cc>

<http://www.manual-lib.com>

<http://www.404manual.com>

<http://www.luxmanual.com>

<http://aubethermostatmanual.com>

Golf course search by state

<http://golfingnear.com>

Email search by domain

<http://emailbydomain.com>

Auto manuals search

<http://auto.somanuals.com>

TV manuals search

<http://tv.somanuals.com>