

JVC



CASSETTE RECEIVER

KS-FX385

ENGLISH

วิทยุเครื่องเล่นเทป

KS-FX385

ไทย

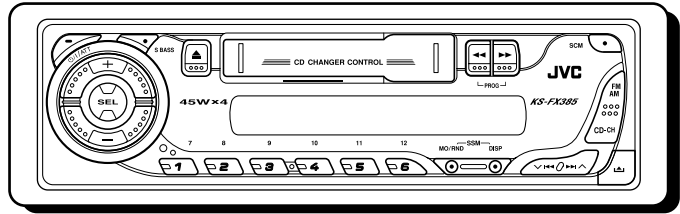
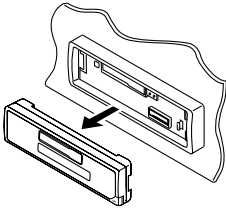

For installation and connections, refer to the separate manual.

กรุณาดูคู่มือที่แยกต่างหาก ในการติดตั้งและการเชื่อมต่อ



INSTRUCTIONS

คำแนะนำ

GET0226-001A
[U/UH]

Thank you for purchasing a JVC product.

Please read all instructions carefully before operation, to ensure your complete understanding and to obtain the best possible performance from the unit.

CONTENTS

How to reset your unit	2	SOUND ADJUSTMENTS	10
LOCATION OF THE BUTTONS	3	Adjusting the sound	10
Control panel	3	Turning on/off the super bass function	10
BASIC OPERATIONS	4	Selecting preset sound modes	11
Turning on the power	4	Storing your own sound adjustments	11
Setting the clock	5	DETACHING THE CONTROL PANEL	12
RADIO OPERATIONS	6	CD CHANGER OPERATIONS	13
Listening to the radio	6	Playing CDs	13
Storing stations in memory	7	Selecting CD playback modes	14
Tuning in to a preset station	8	TROUBLESHOOTING	15
TAPE OPERATIONS	9	MAINTENANCE	16
Listening to a cassette	9	SPECIFICATIONS	17

How to reset your unit

While holding SEL (select), press **⏻/I/ATT** (standby/on/attenuator) button for more than 2 seconds. This will reset the built-in microcomputer.

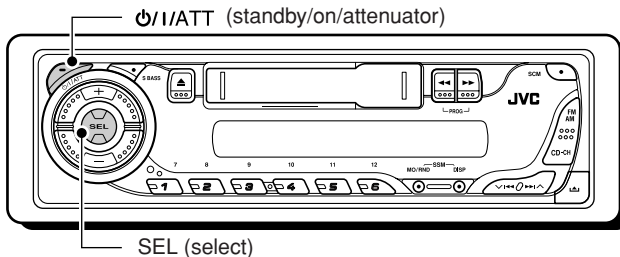

Note:

Your preset adjustments—such as preset channels or sound adjustments—will also be erased.

BEFORE USE

***For safety....**

- Do not raise the volume level too much, as this will block outside sounds, making driving dangerous.
- Stop the car before performing any complicated operations.

***Temperature inside the car....**

If you have parked the car for a long time in hot or cold weather, wait until the temperature in the car becomes normal before operating the unit.



Control panel

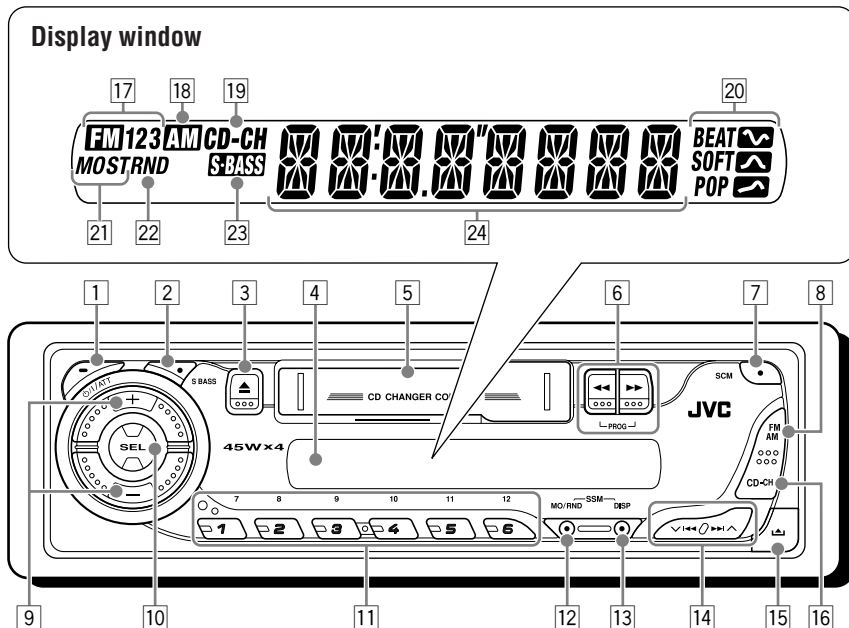

1 (standby/on/attenuator) button

2 S BASS (super bass) button

3 (eject) button

4 Display window

5 Cassette compartment

6 PROG (program) button

7 SCM (sound control memory) button

8 FM AM button

9 +/- buttons

10 SEL (select) button

11 Number buttons

12 MO/RND (monaural/random) button

- Also functions as SSM buttons when pressed together with DISP (display) button.

- RND (random) functions only when connecting to a CD changer.

13 DISP (display) button

- Also functions as SSM buttons when pressed together with MO/RND (monaural/random) button.

14 buttons

15 (control panel release) button

16 CD-CH (CD changer) button

Display window

17 FM band indicators

FM1, FM2, FM3

18 AM band indicator

19 CD-CH (CD changer) indicator

20 Sound mode indicators

BEAT, SOFT, POP

21 Tuner reception indicators

MO (monaural), ST (stereo)

22 RND (random) indicator

- Used only when connecting to a CD changer.

23 S-BASS (super bass) indicator

24 Main display



BASIC OPERATIONS

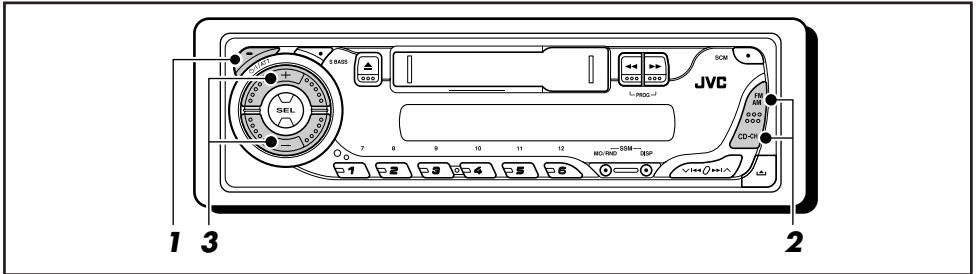

Turning on the power

1 Turn on the power.



Note on One-Touch Operation:

When you select a source in step 2 below, the power automatically comes on. You do not have to press this button to turn on the power.

2 Select the source.

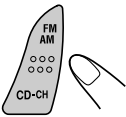

To operate the tuner (FM or AM), see pages 6 – 8.

To play a tape, see page 9.

To operate the CD changer, see pages 13 – 14.

3 Adjust the volume.

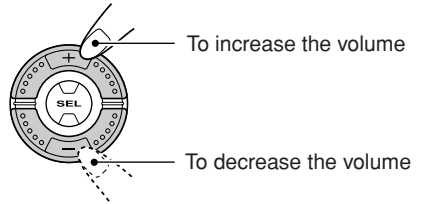

Volume level appears.

4 Adjust the sound as you want. (See pages 10 and 11.)

To drop the volume in a moment

Press **O/I/ATT** briefly while listening to any source. "ATT" starts flashing on the display, and the volume level will drop in a moment.

To resume the previous volume level, press the button briefly again.

To turn off the power

Press and hold **O/I/ATT** for more than one second.

"SEE YOU" appears, then the unit turns off.

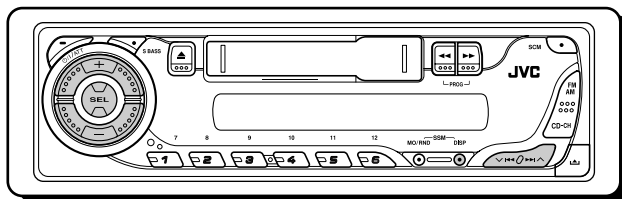

Setting the clock

- 1 Press and hold SEL (select) for more than 2 seconds.



"CLOCK H" or "CLOCK M" appears on the display.

- 2 Set the hour.

- 1 Select "CLOCK H" (hour) if not shown on the display.
- 2 Adjust the hour.

1



2



- 3 Set the minute.

- 1 Select "CLOCK M" (minute).
- 2 Adjust the minute.

1



2

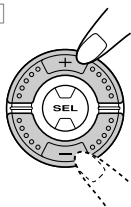

- 4 Finish the setting.



To check the current clock time or change the display mode

DISP



Press DISP (display) repeatedly. Each time you press the button, the display mode changes as follows:

- During tuner operation:

Frequency ↔ Clock

- During tape operation:

Play mode (TAPE) ↔ Clock

- During CD Changer operation:





RADIO OPERATIONS

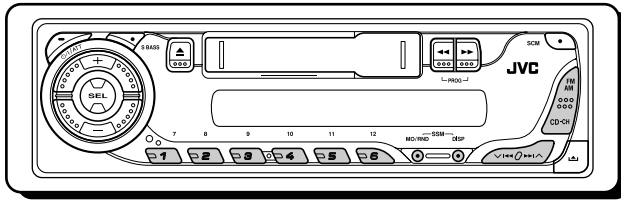

Listening to the radio

You can use either automatic searching or manual searching to tune in to a particular station.

Note:

When a cassette is in the cassette compartment, you cannot select the tuner. Be sure to eject the cassette from the cassette compartment to listen to the radio.

Searching for a station automatically: Auto search

1 Select the band (FM1 – 3, AM).

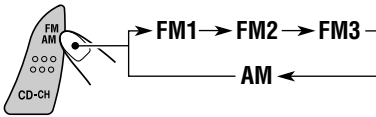

Selected band appears.

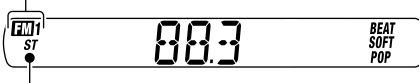

Lights up when receiving an FM stereo broadcast with sufficient signal strength.

Note:

This receiver has three FM bands (FM1, FM2, FM3). You can use any one of them to listen to an FM broadcast.

2 Start searching for a station.

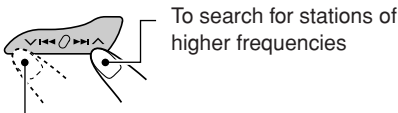

To search for stations of higher frequencies

To search for stations of lower frequencies

When a station is received, searching stops.

To stop searching before a station is received, press the same button you have pressed for searching.

Searching for a station manually: Manual search

1 Select the band (FM1 – 3, AM).

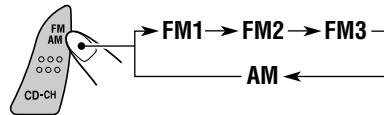

Note:

This receiver has three FM bands (FM1, FM2, FM3). You can use any one of them to listen to an FM broadcast.

2 Press and hold >>> ^ or v <<< until "M" (manual) starts flashing on the display.

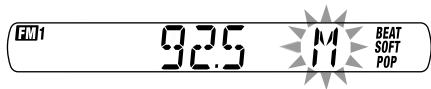
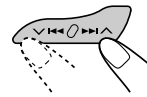

3 Tune in to a station you want while “M” (manual) is still flashing.

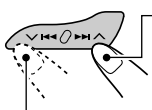

To tune in to stations of higher frequencies

To tune in to stations of lower frequencies

- If you release your finger from the button, the manual mode will automatically turn off after 5 seconds.
- If you hold down the button, the frequency keeps changing (in 50 kHz intervals for FM and 9 kHz intervals for AM) until you release the button.

When an FM stereo broadcast is hard to receive:

MO/RND



Press MO/RND (monaural/random), while listening to an FM stereo broadcast.

Each time you press the button, the MO indicator lights up and goes off alternately.



MO (monaural) indicator

When the MO indicator is lit on the display, the sound you hear becomes monaural but the reception will be improved.

To restore the stereo effect, press the same button again.

Storing stations in memory

You can use one of the following two methods to store broadcasting stations in memory.

- Automatic preset of FM stations: SSM (Strong-station Sequential Memory)
- Manual preset of both FM and AM stations

FM station automatic preset: SSM

You can preset 6 local FM stations in each FM band (FM1, FM2, and FM3).

1 Select the FM band (FM1 – 3) you want to store FM stations into.

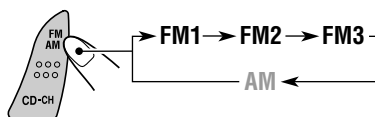

2 Press and hold both buttons for more than 2 seconds.

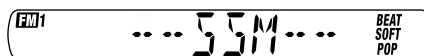
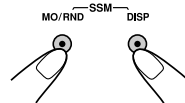

“SSM” appears, then disappears when automatic preset is over.

Local FM stations with the strongest signals are searched and stored automatically in the band number you have selected (FM1, FM2, or FM3). These stations are preset in the number buttons —No.1 (lowest frequency) to No.6 (highest frequency).

When automatic preset is over, the station stored in number button 1 will be automatically tuned in.



Manual preset

You can preset up to 6 stations in each band (FM1, FM2, FM3, and AM) manually.

Ex.: Storing FM station of 92.5 MHz into the preset number 1 of the FM1 band.

- 1** Select the band (FM1 – 3, AM) you want to store stations into (in this example, FM1).



- 2** Tune in to a station (in this example, of 92.5 MHz).

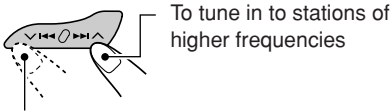

To tune in to stations of lower frequencies



- 3** Press and hold the number button (in this example, 1) for more than 2 seconds.

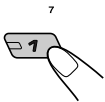

Preset number flashes for a while.

- 4** Repeat the above procedure to store other stations into other preset numbers.

Notes:

- A previously preset station is erased when a new station is stored in the same preset number.
- Preset stations are erased when the power supply to the memory circuit is interrupted (for example, during battery replacement). If this occurs, preset the stations again.

Tuning in to a preset station

You can easily tune in to a preset station. Remember that you must store stations first. If you have not stored them yet, see “Storing stations in memory” on pages 7 and 8.

- 1** Select the band (FM1 – 3, AM).



- 2** Select the number (1 – 6) for the preset station you want.

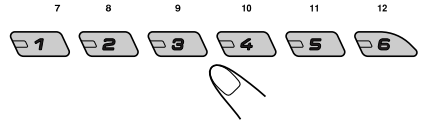

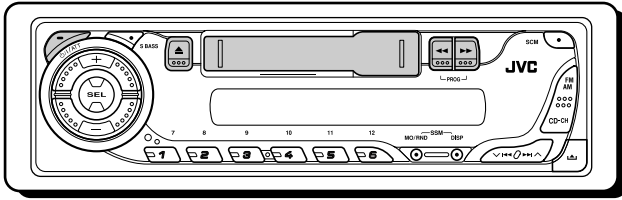

Listening to a cassette

You can play back type I (normal) tapes.

1 Turn on the power.



Note on One-Touch Operation:

When a cassette is already in the cassette compartment, tape play starts automatically. However, it is not recommended to leave the cassette in the compartment when turning off the power. It may damage the tape head and the cassette.

2 Insert a cassette into the cassette compartment.

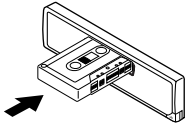

When one side of the tape reaches its end during play, the other side of the tape automatically starts playing. (Auto Reverse)

3 Select the tape direction.



Press both buttons at the same time. Each time you press both buttons, the tape direction changes alternately—forward (TAPPE >>>) and reverse (TAPPE <<<).

To stop play and eject the cassette

Press ▲.

Tape play stops, the cassette automatically ejects from the cassette compartment. The source changes to the previously selected one.

- You cannot change the source if the cassette is still in the cassette compartment. To change the source, you must eject the cassette first.
- You can also eject the cassette by pressing ▲ while the unit is turned off.

To fast wind a tape

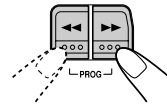

Press in ►► or ◀◀.

The tape will be wound in the direction of the arrows (►► or ◀◀).



Tape direction



To restart playback, lightly press the other button which is not pressed in (◀◀ or ►►).



SOUND ADJUSTMENTS

ENGLISH

Adjusting the sound

You can adjust the sound characteristics to your preference.

1 Select the item you want to adjust.



Each time you press the button, the adjustable items change as follows:

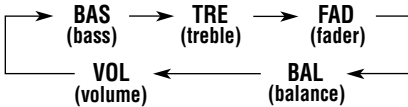

Indication	To do:	Range
BAS (Bass)	Adjust the bass.	-6 (min.) +6 (max.)
TRE (Treble)	Adjust the treble.	-6 (min.) +6 (max.)
FAD* ¹ (Fader)	Adjust the front and rear speaker balance.	R6 (Rear only) F6 (Front only)
BAL (Balance)	Adjust the left and right speaker balance.	L6 (Left only) R6 (Right only)
VOL* ² (Volume)	Adjust the volume.	00 (min.) 50 (max.)

*¹ If you are using a two-speaker system, set the fader level to "00."

*² Normally, the + and - buttons work as the volume control buttons. So you do not have to select "VOL" to adjust the volume level.

2 Adjust the level.

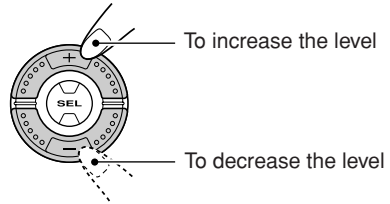

Ex.: When you select "TRE" (treble)

3 Repeat steps 1 and 2 to adjust the other items.

Turning on/off the super bass function

The super bass function allows you to maintain the richness and fullness of the bass sound regardless of how low you set the volume.



Each time you press the button, the function turns on and off alternately.

S-BASS indicator

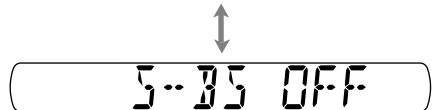
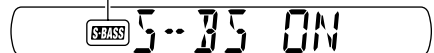



Selecting preset sound modes

You can select a preset sound adjustment suitable to the music genre.

Select the sound mode you want.

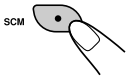

Each time you press the button, the sound mode changes as follows:



Ex.: When you select "BEAT"

Indication	For:	Preset values		
		BAS	TRE	S.BASS
SCM OFF	(Flat sound)	00	00	OFF
BEAT	Rock or disco music	+2	00	ON
SOFT	Quiet background music	+1	-3	OFF
POP	Light music	+4	+1	OFF

Notes:

- You can adjust each sound mode to your preference, and store it in memory.
If you want to adjust and store your original sound mode, see "Storing your own sound adjustments" below.
- To adjust the bass and treble reinforcement levels or to turn on/off the super bass function, see page 10.

Storing your own sound adjustments

You can adjust the sound modes (BEAT, SOFT, POP) to your preference and store your own adjustments in memory.

- There is a time limit in doing the following procedure. If the setting is canceled before you finish, start from step 1 again.

1 Call up the sound mode you want to adjust.

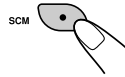

- See on the left column for details.

2 To adjust the bass or treble level.

- Select "BAS" (bass) or "TRE" (treble).



- Adjust the level.



To turn on or off the super bass function.



- See page 10 for details.

3 Repeat step 2 to adjust the other items.

4 Press and hold SCM until the sound mode you have selected in step 1 flashes on the display.

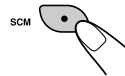

Your adjustment made for the selected sound mode is stored in memory.

5 Repeat the same procedure to store other sound modes.

To reset to the factory settings, repeat the same procedure and reassign the preset values listed in the table on the left column.

You can detach the control panel when leaving the car.

When detaching or attaching the control panel, be careful not to damage the connectors on the back of the control panel and on the panel holder.

Detaching the control panel

Before detaching the control panel, be sure to turn off the power.

1 Unlock the control panel.

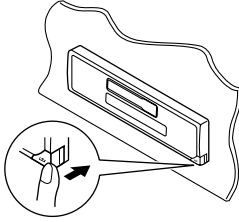

2 Lift and pull the control panel out of the unit.

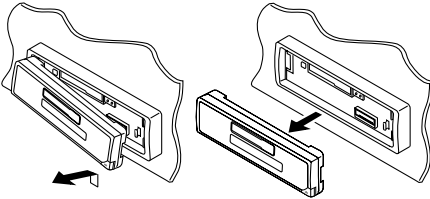

3 Put the detached control panel into the provided case.

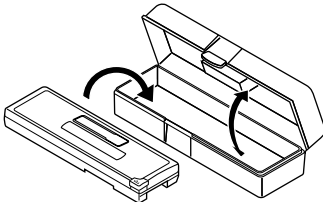

Attaching the control panel

1 Insert the left side of the control panel into the groove on the panel holder.

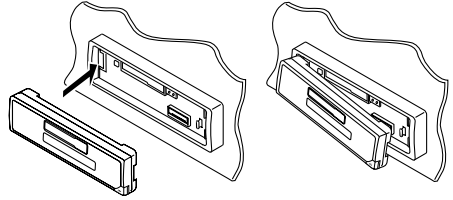

2 Press the right side of the control panel to fix it to the panel holder.

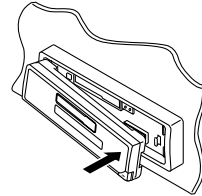

Note on cleaning the connectors:

If you frequently detach the control panel, the connectors will deteriorate.

To minimize this possibility, periodically wipe the connectors with a cotton swab or cloth moistened with alcohol, being careful not to damage the connectors.

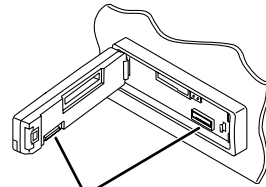

Connectors

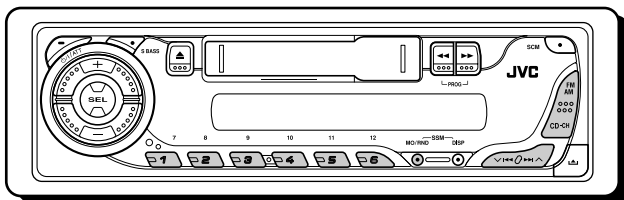

We recommend that you use one of the CH-X series with your unit (except for JVC MP3-compatible CD changer).

If you have another CD changer, consult your JVC car audio dealer for connections.

- For example, if your CD changer is one of the KD-MK series, you need a cord (KS-U15K) for connecting it to this unit.

Before operating your CD changer:

- Refer also to the Instructions supplied with your CD changer.
- If no discs are in the magazine of the CD changer or the discs are inserted upside down, "NO CD" will appear on the display. If this happens, remove the magazine and set the discs correctly.
- If no magazine is loaded in the CD changer, "NO MAG" appears on the display. If this happens, insert the magazine in the CD changer.
- If "RESET 1" – "RESET 8" appears on the display, something is wrong with the connection between this unit and the CD changer. If this happens, check the connection and make sure the cords are connected firmly. Then, press the reset button of the CD changer.

Playing CDs

Select the CD changer (CD-CH).

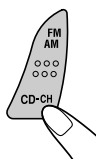

Playback starts from the first track of the first disc.

All tracks of all discs are played back.

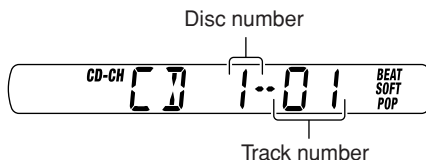

Note on One-Touch Operation:

When you press CD-CH, the power automatically turns on. You do not have to press /WATT to turn on the power.



To fast-forward or reverse the track

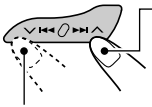

Press and hold ►►► ▲, while playing a CD, to fast-forward the track.

Press and hold ▼ ◄◄, while playing a CD, to reverse the track.

To go to the next or previous tracks

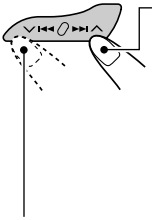

Press ►►► ▲ briefly, while playing a CD, to go ahead to the beginning of the next track. Each time you press the button consecutively, the beginning of the next track is located and played back.

Press ▼ ◄◄ briefly, while playing a CD, to go back to the beginning of the current track.

Each time you press the button consecutively, the beginning of the previous tracks is located and played back.

To go to a particular disc directly

Press the number button corresponding to the disc number to start its playback (while the CD changer is playing).

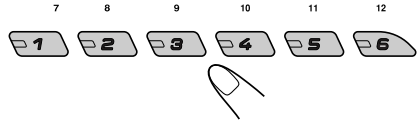

- To select a disc number from 1 – 6:
Press 1 (7) – 6 (12) briefly.
- To select a disc number from 7 – 12:
Press and hold 1 (7) – 6 (12) for more than one second.

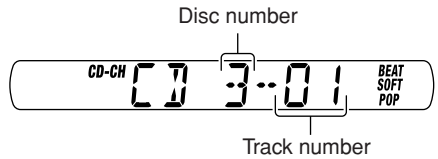

Ex.: When disc number 3 is selected

Selecting CD playback modes

To play back tracks at random (Random Play)

MO/RND



Each time you press the button, CD random play mode changes as follows:



Mode	RND Indicator	Plays at random
RND1	Lights	All tracks of the current disc, then the tracks of the next disc, and so on.
RND2	Flashes	All tracks of all discs inserted in the magazine.

TROUBLESHOOTING

What appears to be trouble is not always serious. Check the following points before calling a service center.

	Symptoms	Causes	Remedies
General	<ul style="list-style-type: none"> Sound cannot be heard from the speakers. 	The volume level is set to the minimum level.	Adjust it to the optimum level.
		Connections are incorrect.	Check the cords and connections.
	<ul style="list-style-type: none"> This unit does not work at all. 	The built-in microcomputer may have functioned incorrectly due to noise, etc.	While holding SEL, press ⏻/1/ATT for more than 2 seconds to reset the unit. (Your preset adjustments will also be erased.) (See page 2.)
FM/AM	<ul style="list-style-type: none"> SSM (Strong-station Sequential Memory) automatic preset does not work. 	Signals are too weak.	Store stations manually.
	<ul style="list-style-type: none"> Static noise while listening to the radio. 	The antenna is not connected firmly.	Connect the antenna firmly.
Tape Playback	<ul style="list-style-type: none"> A cassette tape cannot be inserted. 	You have tried to insert a cassette in the wrong way.	Insert the cassette with the exposed tape facing right.
	<ul style="list-style-type: none"> Cassette tapes become hot. 	This is not a malfunction.	_____
	<ul style="list-style-type: none"> Tape sound is at very low level and sound quality is degraded. 	The tape head is dirty.	Clean it with a head cleaning tape.
CD Changer	<ul style="list-style-type: none"> "NO CD" appears on the display. 	No disc is in the magazine.	Insert discs into the magazine.
		Discs are inserted upside down.	Insert discs correctly.
		Discs are unplayable.	Insert playable discs.
	<ul style="list-style-type: none"> "NO MAG" appears on the display. 	No magazine is loaded in the CD changer.	Insert the magazine.
	<ul style="list-style-type: none"> "RESET 8" appears on the display. 	This unit is not connected to the CD changer correctly.	Connect this unit and the CD changer correctly, then press the reset button of the CD changer.
	<ul style="list-style-type: none"> "RESET 1" – "RESET 7" appears on the display. 	_____	Press the reset button of the CD changer.
	<ul style="list-style-type: none"> The CD changer does not work at all. 	The built-in microcomputer may have functioned incorrectly due to noise, etc.	While holding SEL, press ⏻/1/ATT for more than 2 seconds to reset the unit. (Your preset adjustments will also be erased.) (See page 2.)



MAINTENANCE

ENGLISH

This unit requires very little attention, but you will be able to extend the life of the unit if you follow the instructions below.

To clean the head

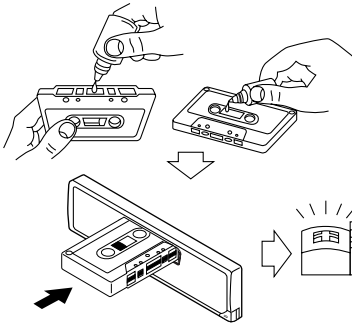

- Clean the heads after every 10 hours of use using a wet-type head cleaning tape (available at an audio store).
When the head becomes dirty, you may realize the following symptoms:
 - Sound quality is reduced.
 - Sound level decreases.
 - Sound drops out.
- Do not play dirty or dusty tapes.
- Do not touch the highly-polished head with any metallic or magnetic tools.

To keep the tape clean

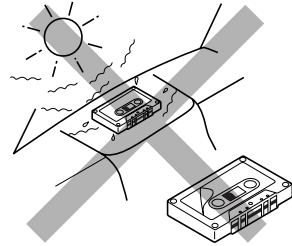

- Always store the cassettes in their storage cases after use.
- Do not store cassettes in the following places:
 - Subject to direct sunlight
 - With high humidity
 - At extremely hot temperatures

CAUTION:

- *Do not play the cassettes with peeling labels; otherwise, they can damage the unit.*
- *Tighten tapes to remove slack since loose tape may become entangled with the mechanism.*
- *Do not leave a cassette in the cassette compartment after use, as the tape may become slack.*

AUDIO AMPLIFIER SECTION

Maximum Power Output:

Front: 45 W per channel

Rear: 45 W per channel

Continuous Power Output (RMS):

Front: 17 W per channel into 4 Ω , 40 Hz
to 20 000 Hz at no more than
0.8% total harmonic distortion.

Rear: 17 W per channel into 4 Ω , 40 Hz
to 20 000 Hz at no more than
0.8% total harmonic distortion.

Load Impedance: 4 Ω (4 Ω to 8 Ω allowance)

Tone Control Range:

Bass: ± 10 dB at 100 Hz

Treble: ± 10 dB at 10 kHz

Frequency Response: 40 Hz to 20 000 Hz

Signal-to-Noise Ratio: 70 dB

Line-Out Level/Impedance:

2.0 V/20 k Ω load (250 nWb/m)

TUNER SECTION

Frequency Range:

FM: 87.5 MHz to 108.0 MHz

AM: 531 kHz to 1 602 kHz

[FM Tuner]

Usable Sensitivity:

11.3 dBf (1.0 μ V/75 Ω)

50 dB Quieting Sensitivity:

16.3 dBf (1.8 μ V/75 Ω)

Alternate Channel Selectivity (400 kHz):

65 dB

Frequency Response: 40 Hz to 15 000 Hz

Stereo Separation: 35 dB

Capture Ratio: 2.0 dB

[AM Tuner]

Sensitivity: 20 μ V

Selectivity: 35 dB

CASSETTE DECK SECTION

Wow & Flutter: 0.15% (WRMS)

Fast-Wind Time: 190 sec. (C-60)

Frequency Response: 50 Hz to 14 000 Hz
(Normal tape)

Signal-to-Noise Ratio: 52 dB

Stereo Separation: 40 dB

GENERAL

Power Requirement:

Operating Voltage: DC 14.4 V

(11 V to 16 V allowance)

Grounding System: Negative ground

Allowable Operating Temperature: 0°C to +40°C

Dimensions (W \times H \times D):

Installation Size (approx.):

182 mm \times 52 mm \times 150 mm

Panel Size (approx.):

188 mm \times 58 mm \times 11 mm

Mass (approx.):

1.3 kg (excluding accessories)

*Design and specifications are subject to change
without notice.*

Having TROUBLE with operation?

Please reset your unit

Refer to page of How to reset your unit



ENGLISH

This unit is designed to operate on **12 V DC, NEGATIVE ground electrical systems**. If your vehicle does not have this system, a voltage inverter is required, which can be purchased at JVC car audio dealers.

ไทย

ชุดประกอบนี้ได้รับการออกแบบมาเพื่อใช้งานกับระบบ กระแสไฟฟ้าสายดินขั้วลบกระแสตรง **12 โวลท์** หากรถยนต์ของคุณไม่ได้ใช้ระบบนี้ ต้องใช้เครื่องแปลงกระแสไฟด้วย ซึ่งสามารถหาซื้อได้จากร้านขายเครื่องเสียงรถยนต์ JVC

Parts list for installation and connection

The following parts are provided for this unit.
After checking them, please set them correctly.

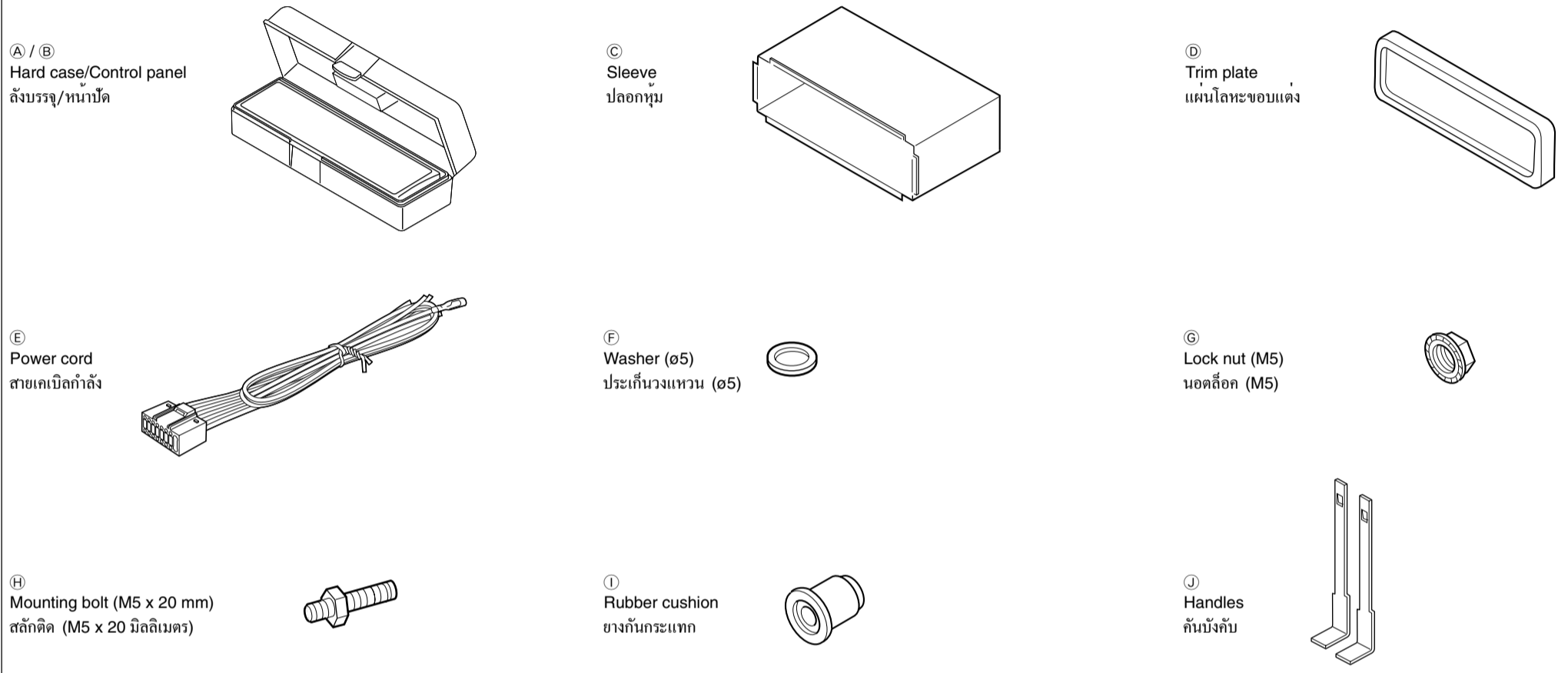

รายการส่วนประกอบสำหรับติดตั้งและเชื่อมต่อกัน

ส่วนประกอบต่อไปนี้ใหม่กับชุดประกอบนี้ หลังจากตรวจสอบแล้ว ปรับตั้งเครื่องให้ถูกต้อง

INSTALLATION (IN-DASH MOUNTING)

The following illustration shows a typical installation. If you have any questions or require information regarding installation kits, consult your JVC car audio dealer or a company supplying kits.

- If you are not sure how to install this unit correctly, have it installed by a qualified technician.

การติดตั้ง (การประกอบแผงหน้าปัดเข็ม)

ภาพตัวอย่างต่อไปนี้แสดงถึงการติดตั้งแบบทั่วไป หากคุณมีปัญหาหรือต้องการข้อมูลเพิ่มเติมเกี่ยวกับชุดติดตั้ง กรุณาปรึกษากับผู้ขายเครื่องเสียงรถยนต์ JVC ของท่านหรือบริษัท

- ชุดประกอบ ถ้าคุณไม่แน่ใจว่าติดตั้งชุดประกอบนี้ถูกต้องหรือไม่ ให้หาช่างผู้เชี่ยวชาญเป็นผู้ติดตั้ง

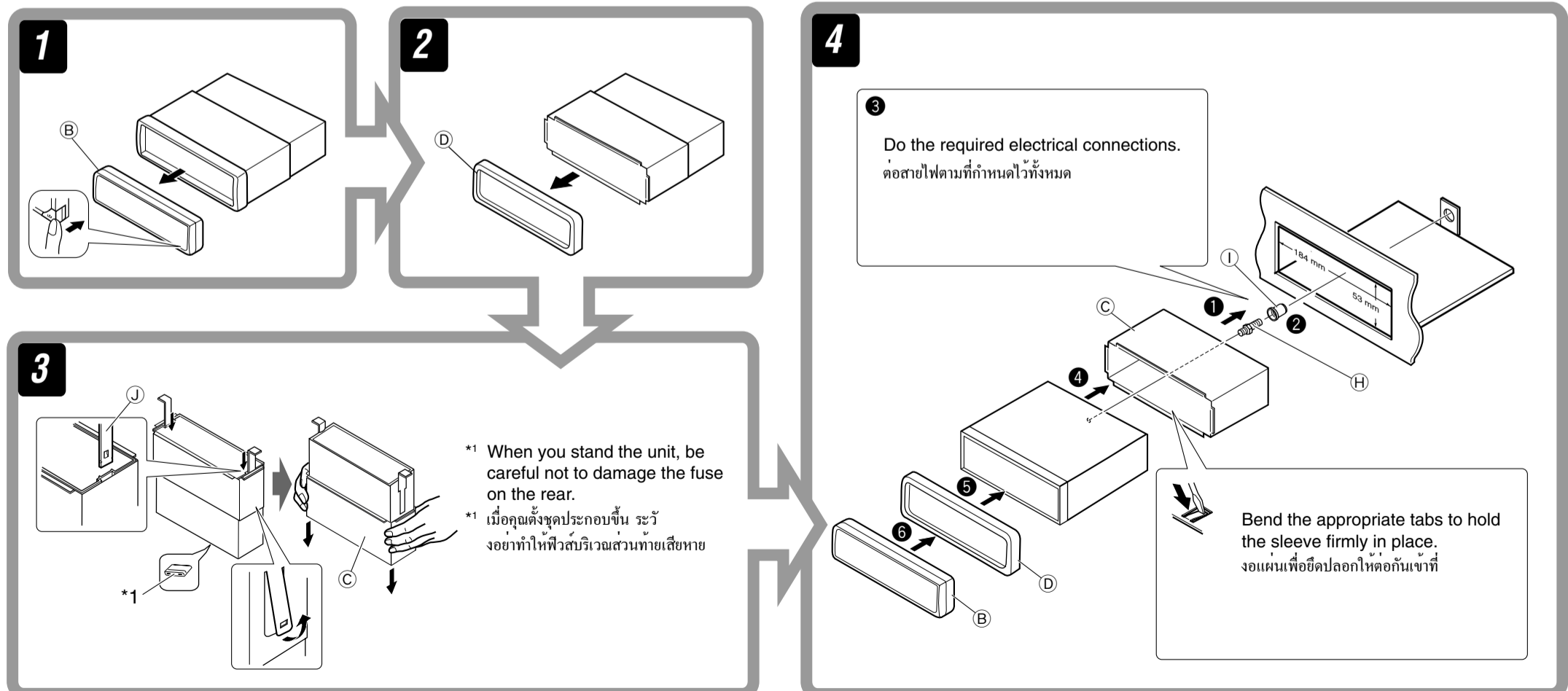

Removing the unit

Before removing the unit, release the rear section.

การถอดชุดประกอบ

ก่อนจะถอดชุดประกอบ ให้ปลดหน้าตัดส่วนท้ายก่อน

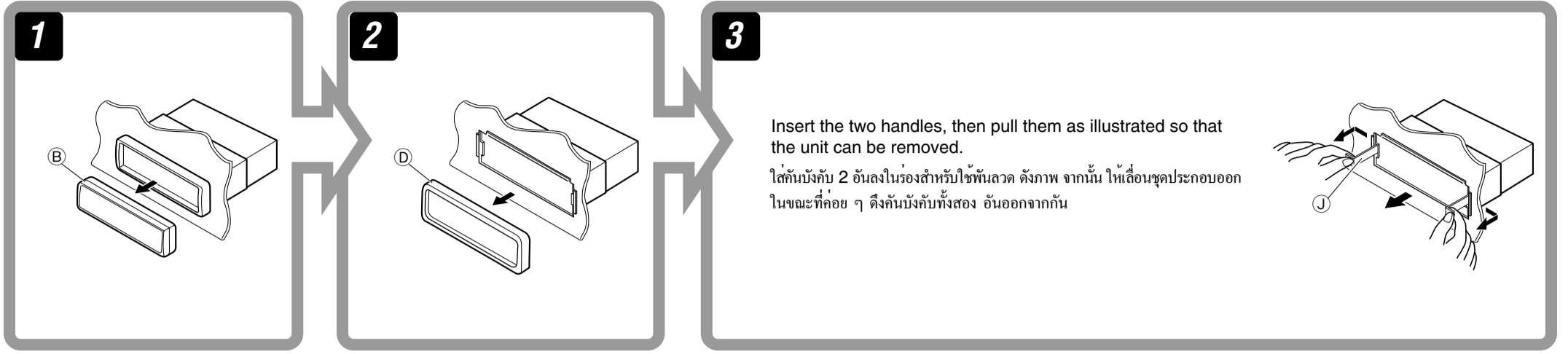

When using the optional stay / เมื่อใช้ตัวยึดแบบเลือกได้ (สามารถเลือกเปิดค้างไว้ได้)

When installing the unit without using the sleeve / เมื่อติดตั้งชุดประกอบโดยไม่ใช้ปลอกหุ้ม

In a Toyota for example, first remove the car radio and install the unit in its place.
ตัวอย่างเช่น ในรถยนต์โตโยตา ให้ถอดวิทยุติดรถยนต์ออกก่อนและติดตั้งชุดประกอบนี้เข้าไปแทน

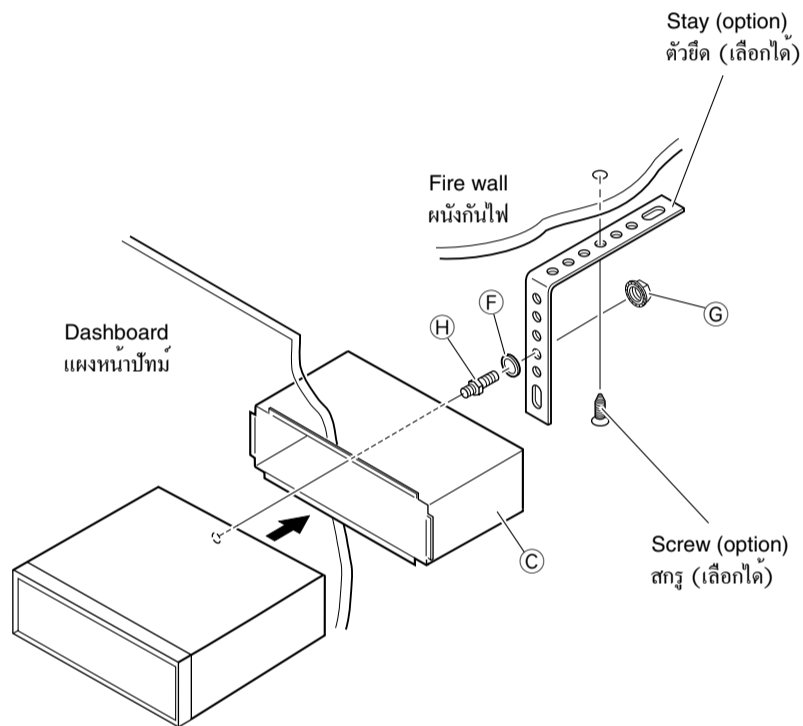

Flat type screws (M5 x 8 mm)*
สกรูหัวเรียบ (M5 x 8 มิลลิเมตร)*

* Not included with this unit.
* ไม่ได้ให้มาพร้อมกับชุดประกอบ

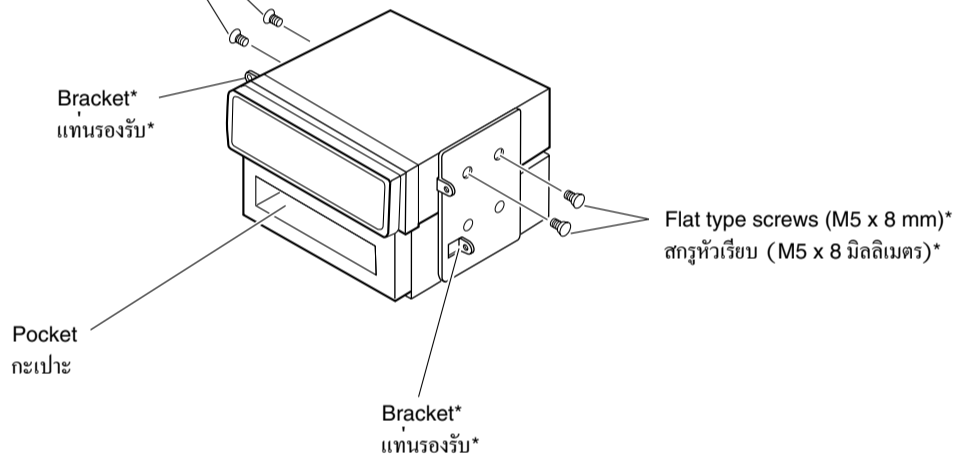

Note

หมายเหตุ

: When installing the unit on the mounting bracket, make sure to use the 8 mm-long screws. If longer screws are used, they could damage the unit.

: เมื่อติดตั้งชุดประกอบลงในแท่นรองรับไว้ ให้ใช้สกรูยาวขนาด 8 มิลลิเมตร ถ้าใช้สกรูยาวกว่านี้อาจทำให้ชุดประกอบเสียหายได้

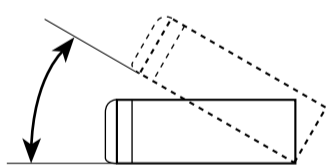

Install the unit at an angle of less than 30°.
ติดตั้งชุดประกอบที่มุมต่ำกว่า 30 องศา

TROUBLESHOOTING

การตรวจสอบปัญหาขั้นต้น

- **The fuse blows.**
* Are the red and black leads connected correctly?
- **Power cannot be turned on.**
* Is the yellow lead connected?
- **No sound from the speakers.**
* Is the speaker output lead short-circuited?
- **Sound is distorted.**
* Is the speaker output lead grounded?
* Are the “-” terminals of L and R speakers grounded in common?
- **Noise interfere with sounds.**
* Is the rear ground terminal connected to the car’s chassis using shorter and thicker cords?
- **Unit becomes hot.**
* Is the speaker output lead grounded?
* Are the “-” terminals of L and R speakers grounded in common?

- **ฟิวส์ขาด**
* มีการเชื่อมต่อสายตะกั่วสีแดงและสีดำอย่างถูกต้องหรือไม่
- **ไม่สามารถเปิดเครื่องได้**
* มีการเชื่อมต่อสายตะกั่วสีเหลืองหรือไม่
- **ไม่มีเสียงออกจากลำโพง**
* สายตะกั่วส่วนที่ออกทางลำโพงเกิดไฟฟ้าลัดวงจรหรือไม่
- **เสียงเพี้ยน**
* สายตะกั่วส่วนที่ออกทางลำโพงต่อลงดินหรือไม่
* สายขั้วลบ ของลำโพงด้านซ้ายและขวาต่อลงดินตามปกติหรือไม่
- **เสียงรบกวน**
* มีการใช้สายสั้นๆ หรือหนาๆ ต่อจากเครื่องส่วนที่ติดตั้ง ไว้บนพื้นด้านหลังกับตัวถังรถยนต์หรือไม่
- **ชุดประกอบร้อนขึ้น**
* สายตะกั่วส่วนที่ออกทางลำโพงต่อลงดินหรือไม่
* สายขั้วลบ ของลำโพงด้านซ้ายและขวาต่อลงดินตามปกติหรือไม่

ELECTRICAL CONNECTIONS

To prevent short circuits, we recommend that you disconnect the battery's negative terminal and make all electrical connections before installing the unit.

- Be sure to ground this unit to the car's chassis again after installation.

Notes:

- Replace the fuse with one of the specified rating. If the fuse blows frequently, consult your JVC car audio dealer.
- Maximum input of the speakers should be more than 45 W at the rear and 45 W at the front, with an impedance of 4 Ω to 8 Ω.
- To prevent short-circuit, cover the terminals of the UNUSED leads with insulating tape.
- The heat sink becomes very hot after use. Be careful not to touch it when removing this unit.

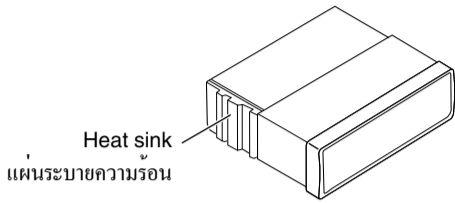

การเชื่อมต่อโดยใช้ไฟฟ้า

เพื่อป้องกันการเกิดไฟฟ้าลัดวงจรขอแนะนำให้ปลดขั้วแบตเตอรี่ลบออก แล้วจึงต่อสายไฟก่อนติดตั้งเครื่อง

- ตรวจสอบให้แน่ใจว่าได้เดินสายดินต่อระหว่างเครื่องกับตัวถัง รถยนต์ใหม่แล้วหลังจากติดตั้ง

หมายเหตุ:

- ใช้ฟิวส์ที่เฉพาะแทนฟิวส์ หากฟิวส์ขาดบ่อย ให้ปรึกษาร้านขายเครื่องเสียงรถยนต์ JVC
- แรงขับสูงสุดเข้าลำโพงไม่ควรเกินกว่า 45 W ที่ลำโพงหลัง และ 45 W ที่ลำโพงหน้า โดยมีความต้านทาน 4 Ω ถึง 8 Ω
- การป้องกันการลัดวงจร จะต้องพันขั้วสายตะกั่ว ที่ไม่ใช้แล้วด้วยเทปพันสายไฟ
- แผ่นระบายความร้อนจะร้อนมากหลังจากใช้ ระวังอย่าไปสัมผัสเมื่อถอดชุดประกอบนี้

A Typical Connections / การเชื่อมต่อแบบปกติ

Before connecting: Check the wiring in the vehicle carefully. Incorrect connection may cause serious damage to this unit.

The leads of the power cord and those of the connector from the car body may be different in color.

- 1 Connect the colored leads of the power cord in the order specified in the illustration below.
- 2 Connect the antenna cord.
- 3 Finally connect the wiring harness to the unit.

ก่อนทำการเชื่อมต่อ: ตรวจสอบการเดินสายไฟในรถอย่างระมัดระวังอย่าให้ผิดพลาดโอกาสที่การเชื่อมต่อผิดพลาดอาจทำให้เกิดความเสียหายแก่ชุดประกอบที่ถอดได้ได้แก่ขั้วของสายไฟ และของอุปกรณ์ต่อเชื่อมจากตัวถัง รถอาจมีที่ไม่เหมาะสม

- 1 ต่อสายไฟสีตามลำดับที่ระบุในรูปด้านล่าง
- 2 เชื่อมต่อกับสายอากาศ
- 3 สุดท้าย ต่อส่วนควบคุมการเดินสายไฟเข้ากับชุดประกอบชุดนี้

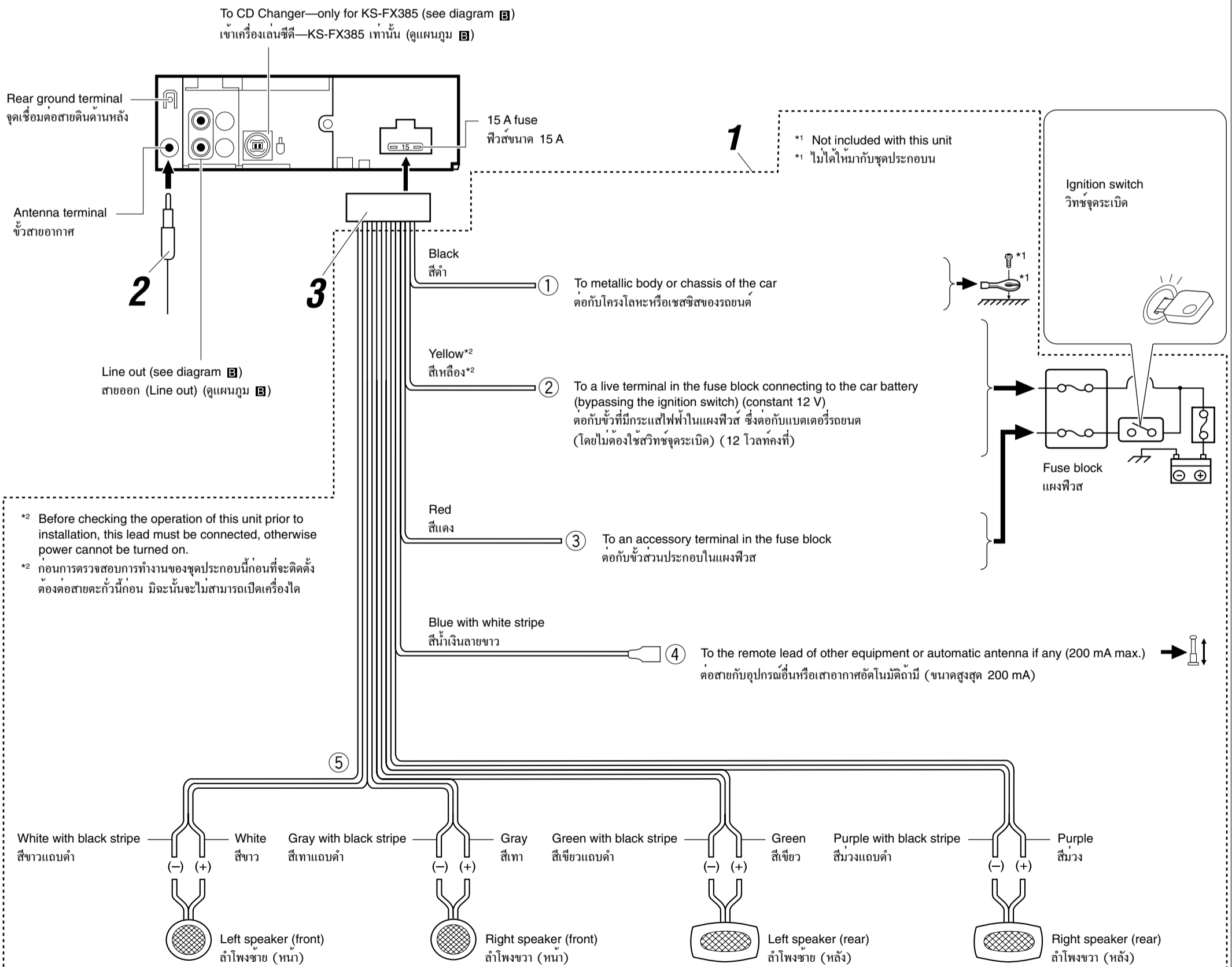

B Connections Adding Other Equipment / การต่อเพิ่มเติมเข้ากับอุปกรณ์อื่น ๆ

Amplifier / เครื่องขยาย

You can connect an amplifier to upgrade your car stereo system.

- Connect the remote lead (blue with white stripe) to the remote lead of the other equipment so that it can be controlled through this unit.
- **Disconnect the speakers from this unit, connect them to the amplifier. Leave the speaker leads of this unit unused.**

คุณสามารถต่อแอมพลิฟายเออร์ เพื่อเพิ่มสมรรถนะให้ระบบสเตอริโอได้

- ต่อสายตะกั่วระยะไกล (สีน้ำเงินลายขาว) เข้ากับสายตะกั่วระยะไกลของอุปกรณ์อื่น ๆ เพื่อจะสามารถควบคุมโดยชุดประกอบนี้ได้
- ถอดลำโพงออกจากชุดประกอบนี้ แล้วต่อเข้ากับเครื่องขยาย ทั้งสายตะกั่วลำโพงของชุดประกอบนี้ไว้

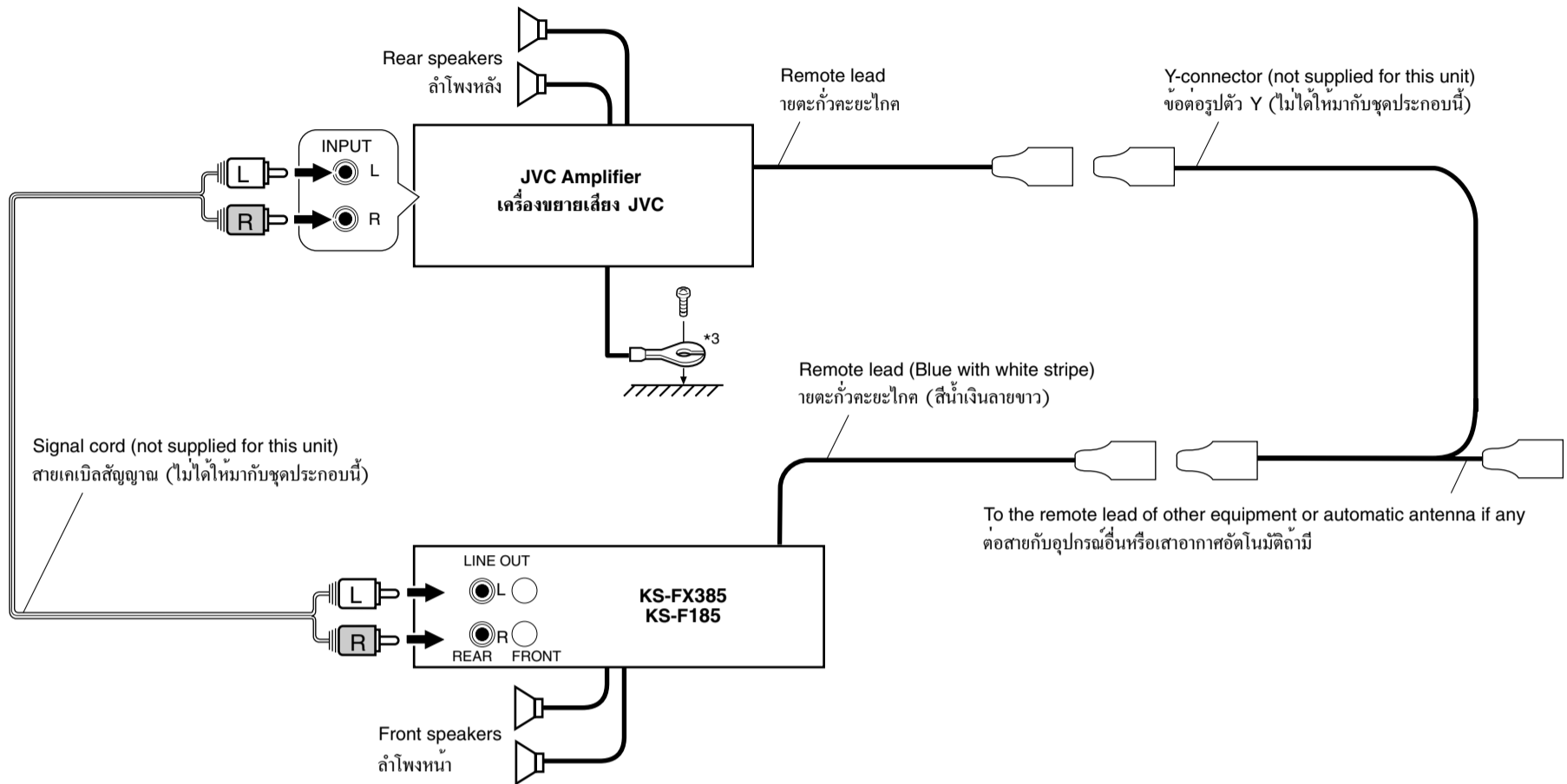

*3 Firmly attach the ground wire to the metallic body or to the chassis of the car—to the place not coated with paint (if coated with paint, remove the paint before attaching the wire). Failure to do so may cause damage to the unit.

*3 ต่อดึงสายดินให้แน่นเข้ากับตัวถังเหล็ก หรือตัวถังรถ — ตรงส่วน ที่ไม่มีสีเคลือบ (หากมีสีเคลือบอยู่ ให้ขูดสีออกก่อน ต่อดึงสายดิน) หากไม่ปฏิบัติตามคำแนะนำนี้ เครื่องอาจชำรุดหรือเสียหายได้

CD Changer / เครื่องเล่นซีดี CD

Only for KS-FX385 / KS-FX385 เท่านั้น

Refer also to page 13 of the INSTRUCTIONS. / ดูข้อแนะนำในหน้า 13

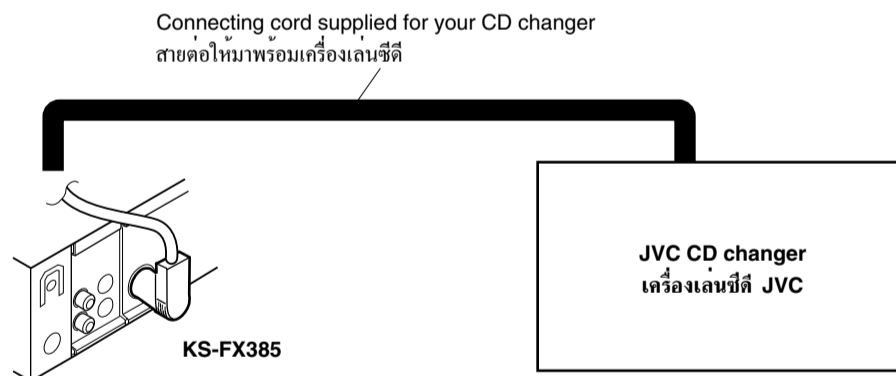

CAUTION / ข้อควรระวัง

- Before connecting the CD changer, make sure that the unit is turned off.
- ก่อนจะเชื่อมต่อเครื่องเล่นซีดี กรุณาตรวจสอบให้แน่ใจว่าเครื่องเล่นซีดีนั้นปิดอยู่

PRECAUTIONS on power supply and speaker connections:

- **DO NOT** connect the speaker leads of the power cord to the car battery; otherwise, the unit will be seriously damaged.
- **BEFORE** connecting the speaker leads of the power cord to the speakers, check the speaker wiring in your car.

ข้อควรระวังสำหรับการต่อแหล่งจ่ายกำลังและลำโพง:

- อย่าต่อสายตะกั่วเคเบิลกำลังของลำโพงเข้ากับแบตเตอรี่รถยนต์ มิฉะนั้น ชุดประกอบจะได้รับความเสียหายมาก
- ก่อนที่จะต่อสายตะกั่วเคเบิลกำลังของลำโพงเข้ากับลำโพง ให้ตรวจสอบการเดินสายไฟลำโพงในรถของคุณให้เรียบร้อยเสียก่อน

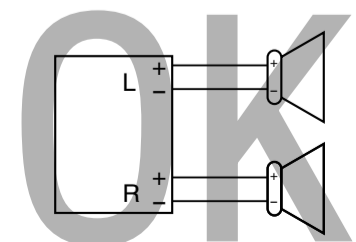
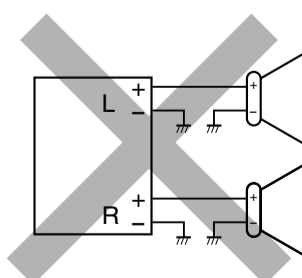
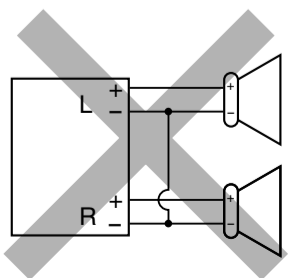

JVC

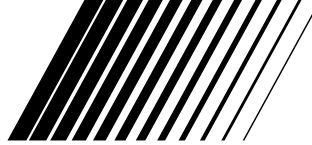

CASSETTE RECEIVER KS-FX385/KS-FX385S/KS-FX385G

ENGLISH

RADIO KASET

KS-FX385/KS-FX385S/KS-FX385G

INDONESIA

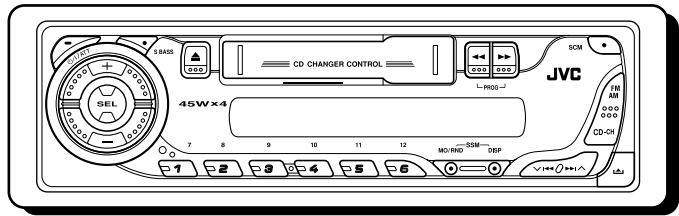
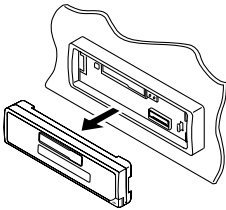

For installation and connections, refer to the separate manual.
Untuk instalasi dan penyambungan, lihat buku pedoman terpisah.

INSTRUCTIONS BUKU PETUNJUK

GET0226-003A
[UN]

Thank you for purchasing a JVC product.

Please read all instructions carefully before operation, to ensure your complete understanding and to obtain the best possible performance from the unit.

CONTENTS

How to reset your unit	2	SOUND ADJUSTMENTS	10
LOCATION OF THE BUTTONS	3	Adjusting the sound	10
Control panel	3	Turning on/off the super bass function	10
BASIC OPERATIONS	4	Selecting preset sound modes	11
Turning on the power	4	Storing your own sound adjustments	11
Setting the clock	5	DETACHING THE CONTROL PANEL	12
RADIO OPERATIONS	6	CD CHANGER OPERATIONS	13
Listening to the radio	6	Playing CDs	13
Storing stations in memory	7	Selecting CD playback modes	14
Tuning in to a preset station	8	TROUBLESHOOTING	15
TAPE OPERATIONS	9	MAINTENANCE	16
Listening to a cassette	9	SPECIFICATIONS	17

How to reset your unit

While holding SEL (select), press **⏻/ATT** (standby/on/attenuator) button for more than 2 seconds. This will reset the built-in microcomputer.

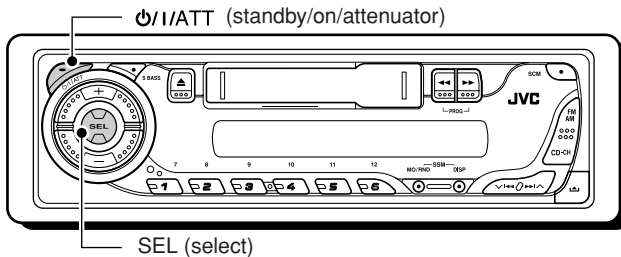

Note:

Your preset adjustments—such as preset channels or sound adjustments—will also be erased.

BEFORE USE

***For safety....**

- Do not raise the volume level too much, as this will block outside sounds, making driving dangerous.
- Stop the car before performing any complicated operations.

***Temperature inside the car....**

If you have parked the car for a long time in hot or cold weather, wait until the temperature in the car becomes normal before operating the unit.

LOCATION OF THE BUTTONS



Control panel

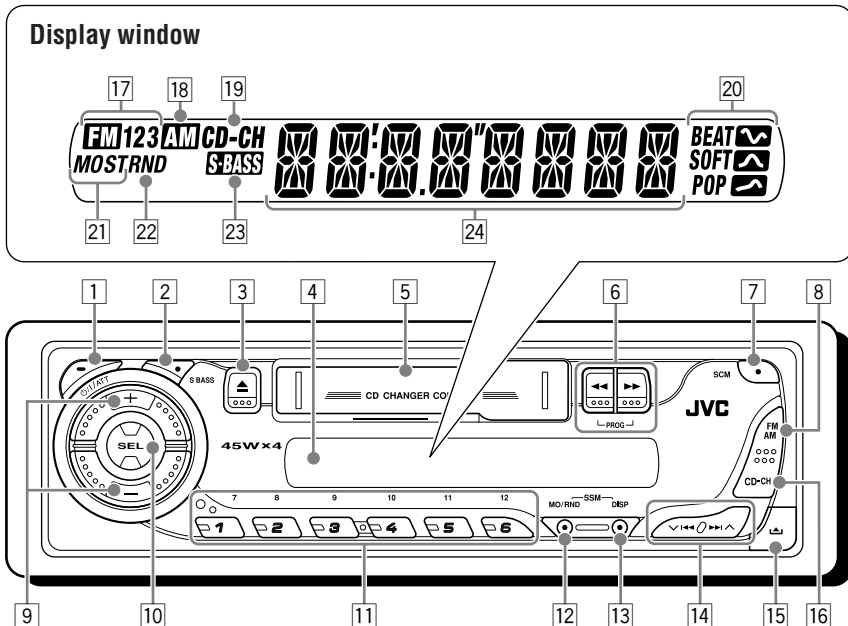

- 1 (standby/on/attenuator) button
- 2 S BASS (super bass) button
- 3 (eject) button
- 4 Display window
- 5 Cassette compartment
- 6 PROG (program) button
- 7 SCM (sound control memory) button
- 8 FM AM button
- 9 +/- buttons
- 10 SEL (select) button
- 11 Number buttons
- 12 MO/RND (monaural/random) button
 - Also functions as SSM buttons when pressed together with DISP (display) button.
 - RND (random) functions only when connecting to a CD changer.
- 13 DISP (display) button
 - Also functions as SSM buttons when pressed together with MO/RND (monaural/random) button.

- 14 buttons
- 15 (control panel release) button
- 16 CD-CH (CD changer) button

Display window

- 17 FM band indicators
FM1, FM2, FM3
- 18 AM band indicator
- 19 CD-CH (CD changer) indicator
- 20 Sound mode indicators
BEAT, SOFT, POP
- 21 Tuner reception indicators
MO (monaural), ST (stereo)
- 22 RND (random) indicator
 - Used only when connecting to a CD changer.
- 23 S-BASS (super bass) indicator
- 24 Main display



BASIC OPERATIONS

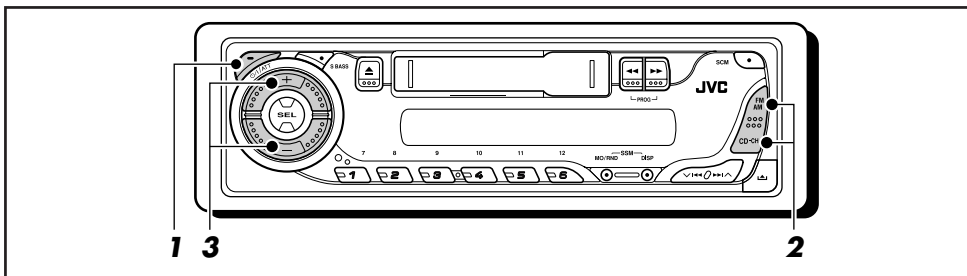

Turning on the power

1 Turn on the power.



Note on One-Touch Operation:

When you select a source in step 2 below, the power automatically comes on. You do not have to press this button to turn on the power.

2 Select the source.

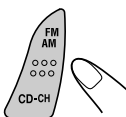

To operate the tuner (FM or AM), see pages 6 – 8.

To play a tape, see page 9.

To operate the CD changer, see pages 13 – 14.

3 Adjust the volume.

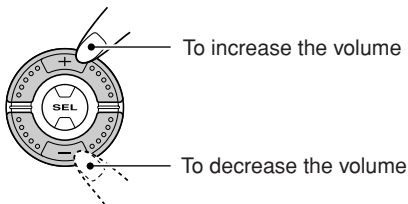

Volume level appears.

4 Adjust the sound as you want. (See pages 10 and 11.)

To drop the volume in a moment

Press **⏻/ATT** briefly while listening to any source. "ATT" starts flashing on the display, and the volume level will drop in a moment.

To resume the previous volume level, press the button briefly again.

To turn off the power

Press and hold **⏻/ATT** for more than one second.

"SEE YOU" appears, then the unit turns off.

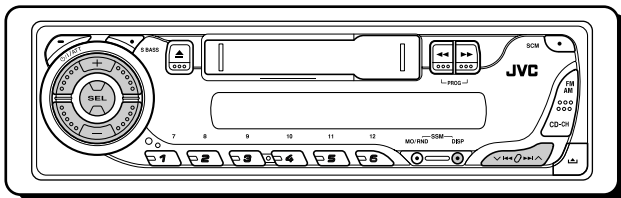

Setting the clock

1 Press and hold SEL (select) for more than 2 seconds.



“CLOCK H” or “CLOCK M” appears on the display.

2 Set the hour.

- 1 Select “CLOCK H” (hour) if not shown on the display.
- 2 Adjust the hour.

1

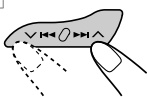

2



3 Set the minute.

- 1 Select “CLOCK M” (minute).
- 2 Adjust the minute.

1

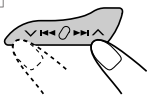

2



4 Finish the setting.



To check the current clock time or change the display mode



Press DISP (display) repeatedly. Each time you press the button, the display mode changes as follows:

• During tuner operation:

Frequency ↔ Clock

• During tape operation:

Play mode (TAPE) ↔ Clock

• During CD Changer operation:





RADIO OPERATIONS

ENGLISH

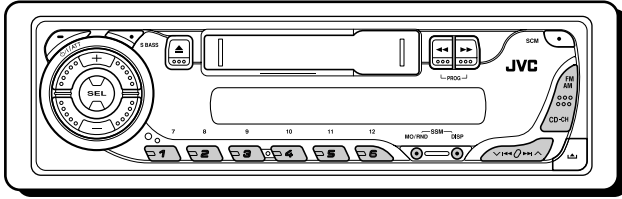

Listening to the radio

You can use either automatic searching or manual searching to tune in to a particular station.

Note:

When a cassette is in the cassette compartment, you cannot select the tuner. Be sure to eject the cassette from the cassette compartment to listen to the radio.

Searching for a station automatically: Auto search

1 Select the band (FM1 – 3, AM).

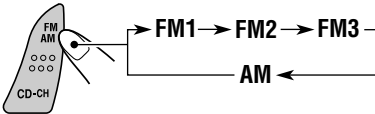

Selected band appears.



Lights up when receiving an FM stereo broadcast with sufficient signal strength.

Note:

This receiver has three FM bands (FM1, FM2, FM3). You can use any one of them to listen to an FM broadcast.

2 Start searching for a station.

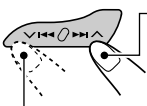

To search for stations of higher frequencies

To search for stations of lower frequencies

When a station is received, searching stops.

To stop searching before a station is received, press the same button you have pressed for searching.

Searching for a station manually: Manual search

1 Select the band (FM1 – 3, AM).

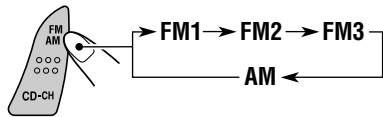

Note:

This receiver has three FM bands (FM1, FM2, FM3). You can use any one of them to listen to an FM broadcast.

2 Press and hold >>> ^ or v <<< until "M" (manual) starts flashing on the display.

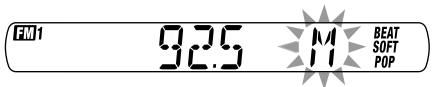
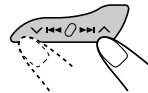

3 Tune in to a station you want while “M” (manual) is still flashing.

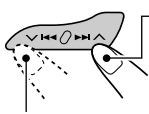

To tune in to stations of higher frequencies

To tune in to stations of lower frequencies

- If you release your finger from the button, the manual mode will automatically turn off after 5 seconds.
- If you hold down the button, the frequency keeps changing (in 50 kHz intervals for FM and 9 kHz intervals for AM) until you release the button.

When an FM stereo broadcast is hard to receive:

MO/RND



Press MO/RND (monaural/random), while listening to an FM stereo broadcast.

Each time you press the button, the MO indicator lights up and goes off alternately.



MO (monaural) indicator

When the MO indicator is lit on the display, the sound you hear becomes monaural but the reception will be improved.

To restore the stereo effect, press the same button again.

Storing stations in memory

You can use one of the following two methods to store broadcasting stations in memory.

- Automatic preset of FM stations: SSM (Strong-station Sequential Memory)
- Manual preset of both FM and AM stations

FM station automatic preset: SSM

You can preset 6 local FM stations in each FM band (FM1, FM2, and FM3).

1 Select the FM band (FM1 – 3) you want to store FM stations into.

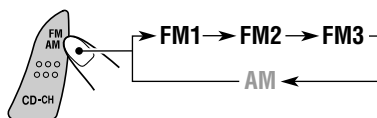

2 Press and hold both buttons for more than 2 seconds.

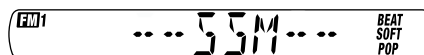
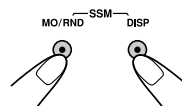

“SSM” appears, then disappears when automatic preset is over.

Local FM stations with the strongest signals are searched and stored automatically in the band number you have selected (FM1, FM2, or FM3). These stations are preset in the number buttons —No.1 (lowest frequency) to No.6 (highest frequency).

When automatic preset is over, the station stored in number button 1 will be automatically tuned in.



Manual preset

You can preset up to 6 stations in each band (FM1, FM2, FM3, and AM) manually.

Ex.: Storing FM station of 92.5 MHz into the preset number 1 of the FM1 band.

- 1** Select the band (FM1 – 3, AM) you want to store stations into (in this example, FM1).



- 2** Tune in to a station (in this example, of 92.5 MHz).

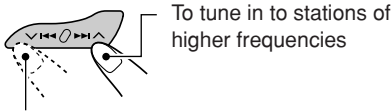

To tune in to stations of lower frequencies



- 3** Press and hold the number button (in this example, 1) for more than 2 seconds.

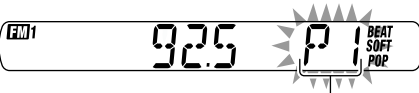
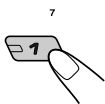

Preset number flashes for a while.

- 4** Repeat the above procedure to store other stations into other preset numbers.

Notes:

- A previously preset station is erased when a new station is stored in the same preset number.
- Preset stations are erased when the power supply to the memory circuit is interrupted (for example, during battery replacement). If this occurs, preset the stations again.

Tuning in to a preset station

You can easily tune in to a preset station. Remember that you must store stations first. If you have not stored them yet, see “Storing stations in memory” on pages 7 and 8.

- 1** Select the band (FM1 – 3, AM).

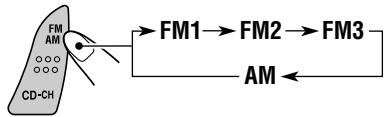

- 2** Select the number (1 – 6) for the preset station you want.

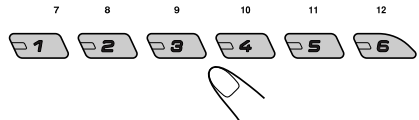

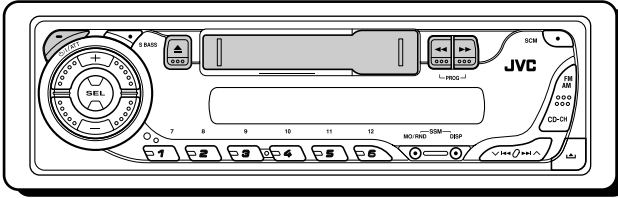

Listening to a cassette

You can play back type I (normal) tapes.

1 Turn on the power.



Note on One-Touch Operation:

When a cassette is already in the cassette compartment, tape play starts automatically. However, it is not recommended to leave the cassette in the compartment when turning off the power. It may damage the tape head and the cassette.

2 Insert a cassette into the cassette compartment.

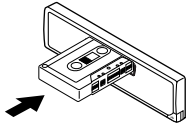

When one side of the tape reaches its end during play, the other side of the tape automatically starts playing. (Auto Reverse)

3 Select the tape direction.



Press both buttons at the same time. Each time you press both buttons, the tape direction changes alternately—forward (TAPPE >>>) and reverse (TAPPE <<<).

To stop play and eject the cassette

Press ▲.

Tape play stops, the cassette automatically ejects from the cassette compartment. The source changes to the previously selected one.

- You cannot change the source if the cassette is still in the cassette compartment.

To change the source, you must eject the cassette first.

- You can also eject the cassette by pressing ▲ while the unit is turned off.

To fast wind a tape

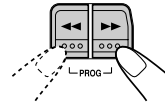

Press in ►► or ◀◀.

The tape will be wound in the direction of the arrows (:>> or <<:).



Tape direction



To restart playback, lightly press the other button which is not pressed in (◀◀ or ►►).



SOUND ADJUSTMENTS

ENGLISH

Adjusting the sound

You can adjust the sound characteristics to your preference.

1 Select the item you want to adjust.



Each time you press the button, the adjustable items change as follows:

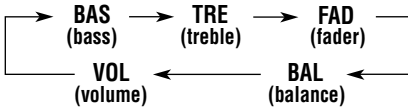

Indication	To do:	Range
BAS (Bass)	Adjust the bass.	-6 (min.) +6 (max.)
TRE (Treble)	Adjust the treble.	-6 (min.) +6 (max.)
FAD* ¹ (Fader)	Adjust the front and rear speaker balance.	R6 (Rear only) F6 (Front only)
BAL (Balance)	Adjust the left and right speaker balance.	L6 (Left only) R6 (Right only)
VOL* ² (Volume)	Adjust the volume.	00 (min.) 50 (max.)

*¹ If you are using a two-speaker system, set the fader level to "00."

*² Normally, the + and - buttons work as the volume control buttons. So you do not have to select "VOL" to adjust the volume level.

2 Adjust the level.

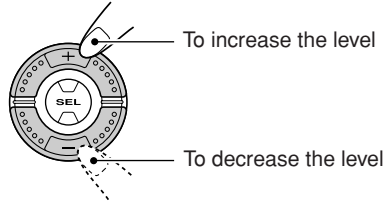

Ex.: When you select "TRE" (treble)

3 Repeat steps 1 and 2 to adjust the other items.

Turning on/off the super bass function

The super bass function allows you to maintain the richness and fullness of the bass sound regardless of how low you set the volume.



Each time you press the button, the function turns on and off alternately.

S-BASS indicator





Selecting preset sound modes

You can select a preset sound adjustment suitable to the music genre.

Select the sound mode you want.



Each time you press the button, the sound mode changes as follows:



Ex.: When you select "BEAT"

Indication	For:	Preset values		
		BAS	TRE	S.BASS
SCM OFF	(Flat sound)	00	00	OFF
BEAT	Rock or disco music	+2	00	ON
SOFT	Quiet background music	+1	-3	OFF
POP	Light music	+4	+1	OFF

Notes:

- You can adjust each sound mode to your preference, and store it in memory.
If you want to adjust and store your original sound mode, see "Storing your own sound adjustments" below.
- To adjust the bass and treble reinforcement levels or to turn on/off the super bass function, see page 10.

Storing your own sound adjustments

You can adjust the sound modes (BEAT, SOFT, POP) to your preference and store your own adjustments in memory.

- There is a time limit in doing the following procedure. If the setting is canceled before you finish, start from step 1 again.

1 Call up the sound mode you want to adjust.

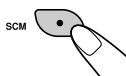

- See on the left column for details.

2 To adjust the bass or treble level.

- Select "BAS" (bass) or "TRE" (treble).



- Adjust the level.



To turn on or off the super bass function.



- See page 10 for details.

3 Repeat step 2 to adjust the other items.

4 Press and hold SCM until the sound mode you have selected in step 1 flashes on the display.

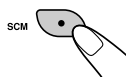

Your adjustment made for the selected sound mode is stored in memory.

5 Repeat the same procedure to store other sound modes.

To reset to the factory settings, repeat the same procedure and reassign the preset values listed in the table on the left column.

You can detach the control panel when leaving the car.

When detaching or attaching the control panel, be careful not to damage the connectors on the back of the control panel and on the panel holder.

Detaching the control panel

Before detaching the control panel, be sure to turn off the power.

1 Unlock the control panel.

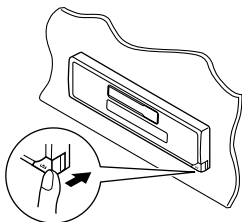

2 Lift and pull the control panel out of the unit.

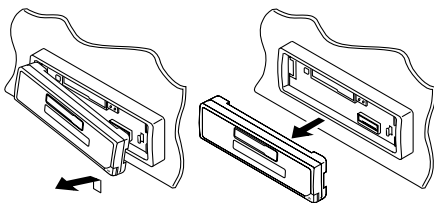

3 Put the detached control panel into the provided case.

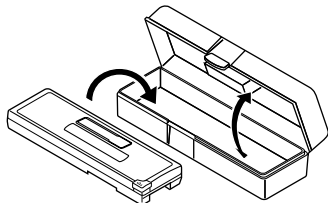

Attaching the control panel

1 Insert the left side of the control panel into the groove on the panel holder.

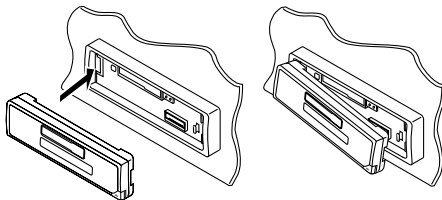

2 Press the right side of the control panel to fix it to the panel holder.

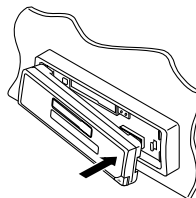

Note on cleaning the connectors:

If you frequently detach the control panel, the connectors will deteriorate. To minimize this possibility, periodically wipe the connectors with a cotton swab or cloth moistened with alcohol, being careful not to damage the connectors.

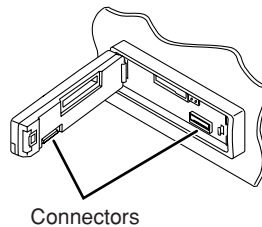

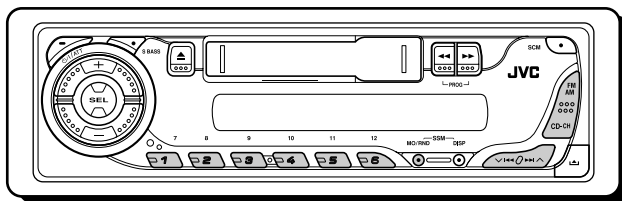

We recommend that you use one of the CH-X series with your unit (except for JVC MP3-compatible CD changer).

If you have another CD changer, consult your JVC car audio dealer for connections.

- For example, if your CD changer is one of the KD-MK series, you need a cord (KS-U15K) for connecting it to this unit.

Before operating your CD changer:

- Refer also to the Instructions supplied with your CD changer.
- If no discs are in the magazine of the CD changer or the discs are inserted upside down, "NO CD" will appear on the display. If this happens, remove the magazine and set the discs correctly.
- If no magazine is loaded in the CD changer, "NO MAG" appears on the display. If this happens, insert the magazine in the CD changer.
- If "RESET 1" – "RESET 8" appears on the display, something is wrong with the connection between this unit and the CD changer. If this happens, check the connection and make sure the cords are connected firmly. Then, press the reset button of the CD changer.

Playing CDs

Select the CD changer (CD-CH).

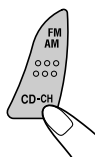

Playback starts from the first track of the first disc.

All tracks of all discs are played back.

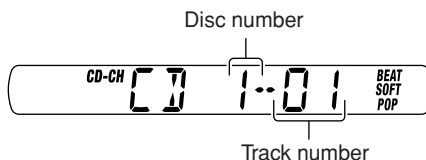

Note on One-Touch Operation:

When you press CD-CH, the power automatically turns on. You do not have to press /ATT to turn on the power.



To fast-forward or reverse the track

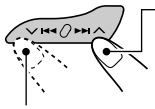

Press and hold **▶▶▶ ▲**, while playing a CD, to fast-forward the track.

Press and hold **◀◀◀ ▼**, while playing a CD, to reverse the track.

To go to the next or previous tracks

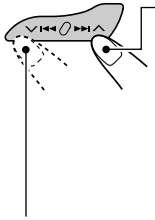

Press **▶▶▶ ▲** briefly, while playing a CD, to go ahead to the beginning of the next track. Each time you press the button consecutively, the beginning of the next track is located and played back.

Press **◀◀◀ ▼** briefly, while playing a CD, to go back to the beginning of the current track. Each time you press the button consecutively, the beginning of the previous tracks is located and played back.

To go to a particular disc directly

Press the number button corresponding to the disc number to start its playback (while the CD changer is playing).

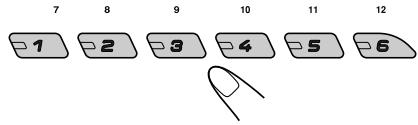

- To select a disc number from 1 – 6: Press 1 (7) – 6 (12) briefly.
- To select a disc number from 7 – 12: Press and hold 1 (7) – 6 (12) for more than one second.

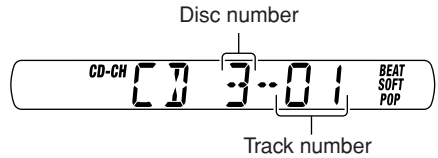

Ex.: When disc number 3 is selected

Selecting CD playback modes

To play back tracks at random (Random Play)



Each time you press the button, CD random play mode changes as follows:



Mode	RND Indicator	Plays at random
RND1	Lights	All tracks of the current disc, then the tracks of the next disc, and so on.
RND2	Flashes	All tracks of all discs inserted in the magazine.

TROUBLESHOOTING



What appears to be trouble is not always serious. Check the following points before calling a service center.

	Symptoms	Causes	Remedies
General	• Sound cannot be heard from the speakers.	The volume level is set to the minimum level.	Adjust it to the optimum level.
		Connections are incorrect.	Check the cords and connections.
	• This unit does not work at all.	The built-in microcomputer may have functioned incorrectly due to noise, etc.	While holding SEL, press ⏻/ATT for more than 2 seconds to reset the unit. (Your preset adjustments will also be erased.) (See page 2.)
FM/AM	• SSM (Strong-station Sequential Memory) automatic preset does not work.	Signals are too weak.	Store stations manually.
	• Static noise while listening to the radio.	The antenna is not connected firmly.	Connect the antenna firmly.
Tape Playback	• A cassette tape cannot be inserted.	You have tried to insert a cassette in the wrong way.	Insert the cassette with the exposed tape facing right.
	• Cassette tapes become hot.	This is not a malfunction.	_____
	• Tape sound is at very low level and sound quality is degraded.	The tape head is dirty.	Clean it with a head cleaning tape.
CD Changer	• "NO CD" appears on the display.	No disc is in the magazine.	Insert discs into the magazine.
		Discs are inserted upside down.	Insert discs correctly.
		Discs are unplayable.	Insert playable discs.
	• "NO MAG" appears on the display.	No magazine is loaded in the CD changer.	Insert the magazine.
	• "RESET 8" appears on the display.	This unit is not connected to the CD changer correctly.	Connect this unit and the CD changer correctly, then press the reset button of the CD changer.
• "RESET 1" – "RESET 7" appears on the display.	_____	Press the reset button of the CD changer.	
	• The CD changer does not work at all.	The built-in microcomputer may have functioned incorrectly due to noise, etc.	While holding SEL, press ⏻/ATT for more than 2 seconds to reset the unit. (Your preset adjustments will also be erased.) (See page 2.)



MAINTENANCE

ENGLISH

This unit requires very little attention, but you will be able to extend the life of the unit if you follow the instructions below.

To clean the head

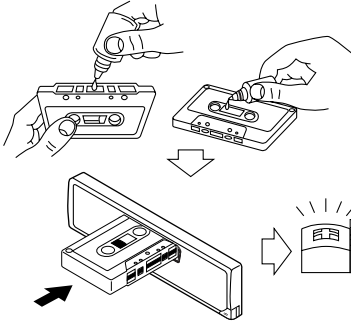

- Clean the heads after every 10 hours of use using a wet-type head cleaning tape (available at an audio store).
When the head becomes dirty, you may realize the following symptoms:
 - Sound quality is reduced.
 - Sound level decreases.
 - Sound drops out.
- Do not play dirty or dusty tapes.
- Do not touch the highly-polished head with any metallic or magnetic tools.

To keep the tape clean

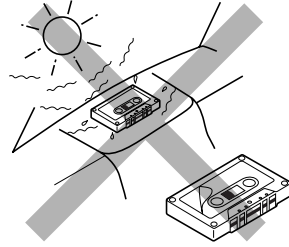

- Always store the cassettes in their storage cases after use.
- Do not store cassettes in the following places:
 - Subject to direct sunlight
 - With high humidity
 - At extremely hot temperatures

CAUTION:

- *Do not play the cassettes with peeling labels; otherwise, they can damage the unit.*
- *Tighten tapes to remove slack since loose tape may become entangled with the mechanism.*
- *Do not leave a cassette in the cassette compartment after use, as the tape may become slack.*

AUDIO AMPLIFIER SECTION

Maximum Power Output:

Front: 45 W per channel

Rear: 45 W per channel

Continuous Power Output (RMS):

Front: 17 W per channel into 4 Ω , 40 Hz to 20 000 Hz at no more than 0.8% total harmonic distortion.

Rear: 17 W per channel into 4 Ω , 40 Hz to 20 000 Hz at no more than 0.8% total harmonic distortion.

Load Impedance: 4 Ω (4 Ω to 8 Ω allowance)

Tone Control Range:

Bass: ± 10 dB at 100 Hz

Treble: ± 10 dB at 10 kHz

Frequency Response: 40 Hz to 20 000 Hz

Signal-to-Noise Ratio: 70 dB

Line-Out Level/Impedance:

2.0 V/20 k Ω load (250 nWb/m)

TUNER SECTION

Frequency Range:

FM: 87.5 MHz to 108.0 MHz

AM: 531 kHz to 1 602 kHz

[FM Tuner]

Usable Sensitivity:

11.3 dBf (1.0 μ V/75 Ω)

50 dB Quieting Sensitivity:

16.3 dBf (1.8 μ V/75 Ω)

Alternate Channel Selectivity (400 kHz):

65 dB

Frequency Response: 40 Hz to 15 000 Hz

Stereo Separation: 35 dB

Capture Ratio: 2.0 dB

[AM Tuner]

Sensitivity: 20 μ V

Selectivity: 35 dB

CASSETTE DECK SECTION

Wow & Flutter: 0.15% (WRMS)

Fast-Wind Time: 190 sec. (C-60)

Frequency Response: 50 Hz to 14 000 Hz
(Normal tape)

Signal-to-Noise Ratio: 52 dB

Stereo Separation: 40 dB

GENERAL

Power Requirement:

Operating Voltage: DC 14.4 V

(11 V to 16 V allowance)

Grounding System: Negative ground

Allowable Operating Temperature: 0°C to +40°C

Dimensions (W \times H \times D):

Installation Size (approx.):

182 mm \times 52 mm \times 150 mm

Panel Size (approx.):

188 mm \times 58 mm \times 11 mm

Mass (approx.):

1.3 kg (excluding accessories)

Design and specifications are subject to change without notice.

**Having TROUBLE with operation?
Please reset your unit
Refer to page of How to reset your unit**



EN, IN

© 2004 VICTOR COMPANY OF JAPAN, LIMITED

0604DTSMDTJEIN

JVC KS-FX385/KS-FX385S/KS-FX385G/ KS-F185/KS-F185S/KS-F185G

Installation/Connection Manual Buku Panduan Instalasi/Penyambungan

GET0225-006A
[UN]

0604DTSMDTJEIN
EN, IN

ENGLISH

This unit is designed to operate on **12 V DC, NEGATIVE ground electrical systems**. If your vehicle does not have this system, a voltage inverter is required, which can be purchased at JVC car audio dealers.

INDONESIA

Unit ini dirancang untuk dipakai pada tegangan **12 V DC, dengan sistem negatif yang di-ground-kan**. Jika peralatan anda tidak memiliki sistem ini, maka dibutuhkan sebuah perubah tegangan, yang dapat dibeli di agen audio mobil JVC.

Parts list for installation and connection

The following parts are provided for this unit.
After checking them, please set them correctly.

(A / B)
Hard case/Control panel
Kotak/Panel kontrol

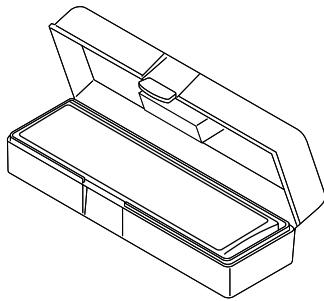

(C)
Sleeve
Mounting sleeve

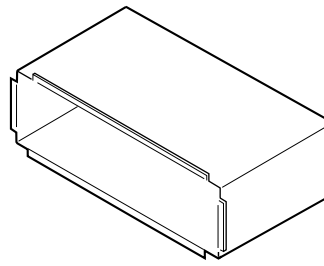

(D)
Trim plate
Trim plate

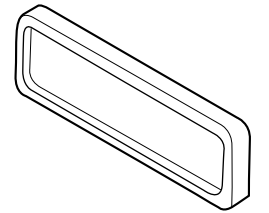

(E)
Power cord
Kabel listrik

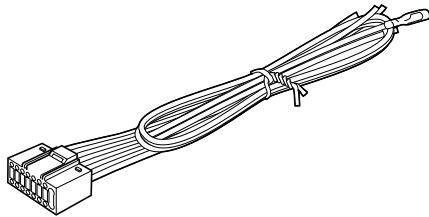

(F)
Washer (ø5)
Ring (ø5)



(G)
Lock nut (M5)
Mur pengunci (M5)



(H)
Mounting bolt (M5 x 20 mm)
Baut pengganjal (M5 x 20 mm)

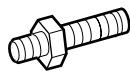

(I)
Rubber cushion
Bantalan karet



(J)
Handles
Handle

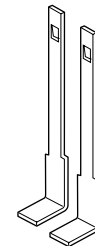

INSTALLATION (IN-DASH MOUNTING)

The following illustration shows a typical installation. If you have any questions or require information regarding installation kits, consult your JVC car audio dealer or a company supplying kits.

- If you are not sure how to install this unit correctly, have it installed by a qualified technician.

INSTALASI (PEMASANGAN PADA DASBOARD)

Ilustrasi berikut akan menjelaskan instruksi umum untuk instalasi. Apabila anda membutuhkan informasi lebih lanjut, silakan konsultasi dengan dealer audio mobil JVC terdekat ataupun perusahaan alat-alat elektronik.

- Apabila anda tidak mengetahui dengan pasti bagaimana memasang unit ini dengan benar, tanyakan pada teknisi yang berpengalaman untuk pemasangannya.

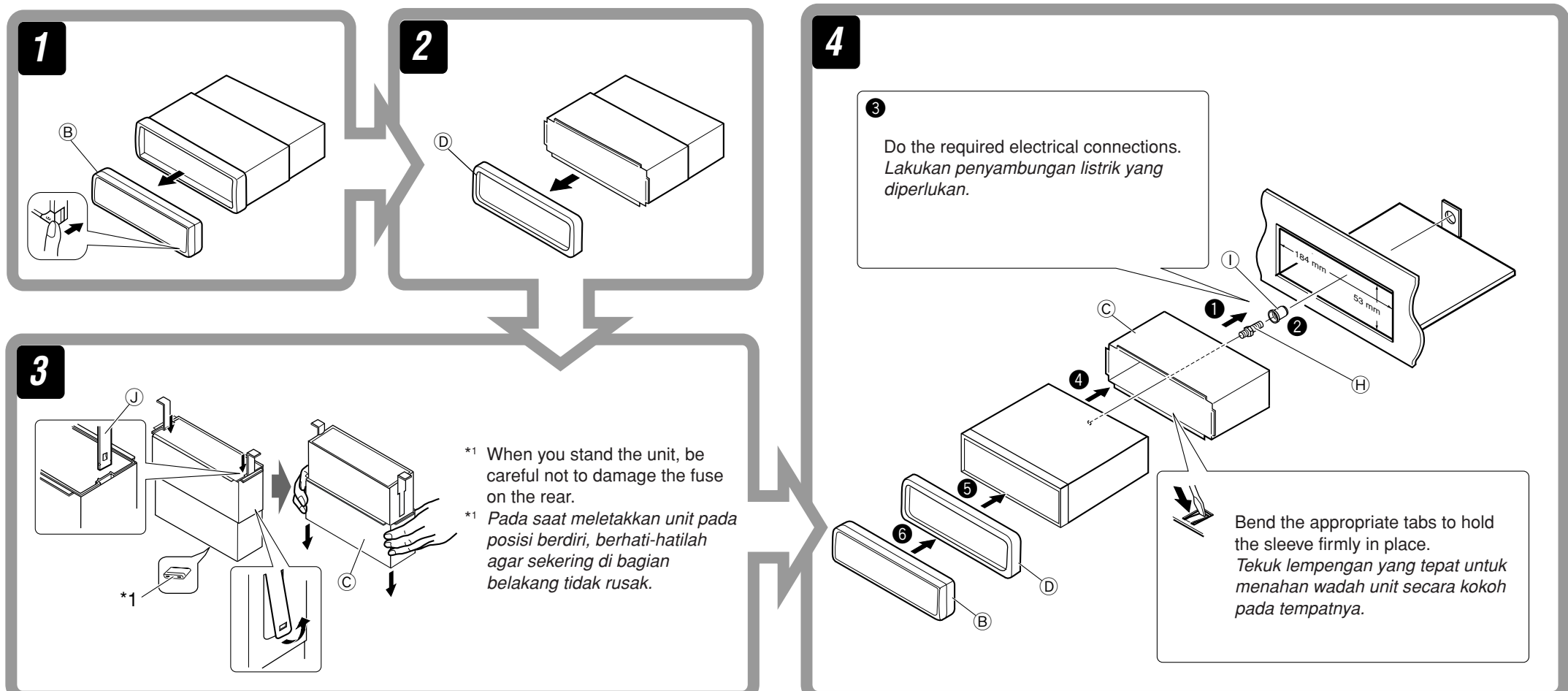

Removing the unit

Before removing the unit, release the rear section.

Melepaskan unit

Sebelum melepaskan unit, lepaskan terlebih dahulu bagian belakangnya.

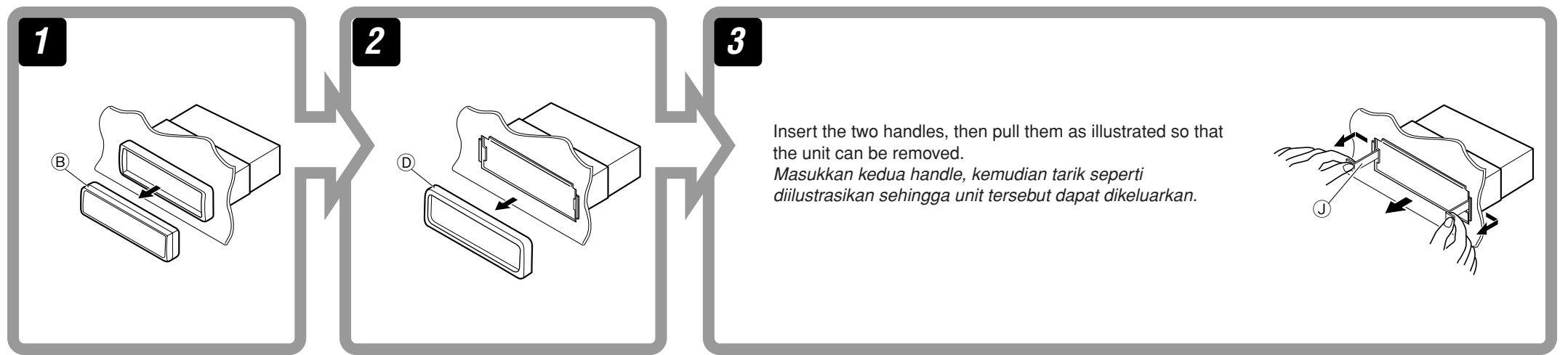

When using the optional stay/Pemasangan pilihan

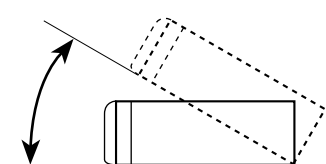
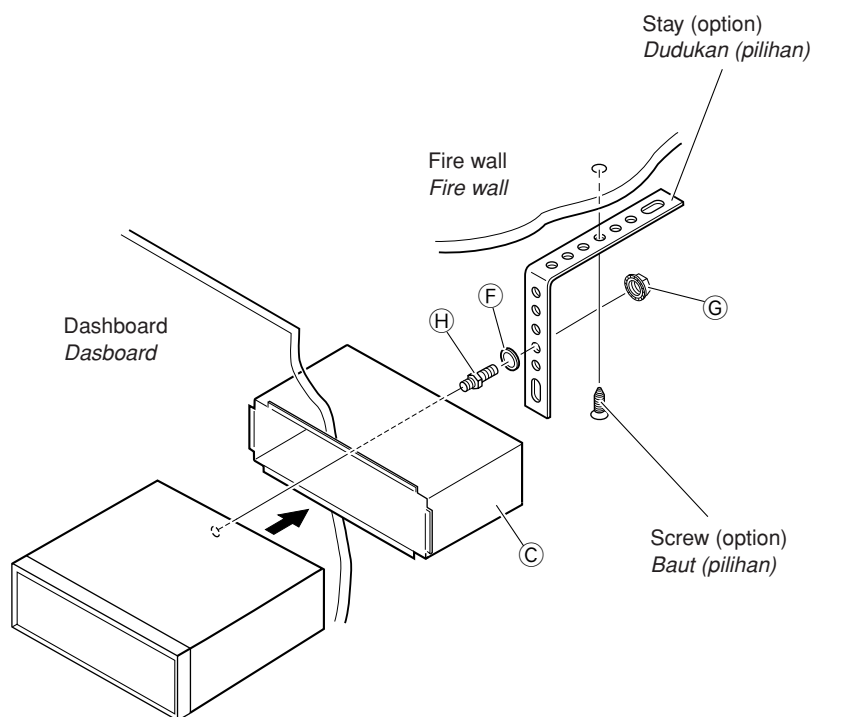

Install the unit at an angle of less than 30°.
Pasang unit tersebut pada sudut kurang dari 30°.

When installing the unit without using the sleeve/Instalasi unit tanpa mounting sleeve

In a Toyota for example, first remove the car radio and install the unit in its place.
Sebagai contoh untuk mobil Toyota, lepaskan radio mobil terlebih dahulu dan kemudian pasang unit di tempat yang sama.

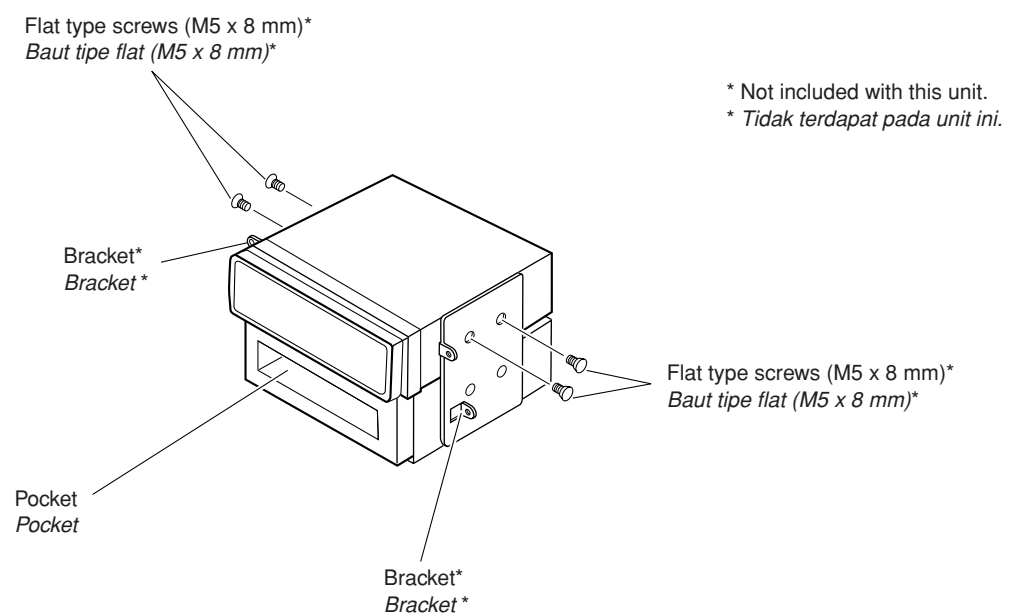

Note : When installing the unit on the mounting bracket, make sure to use the 8 mm-long screws. If longer screws are used, they could damage the unit.
Catatan : Saat memasang unit pada bracket, gunakan baut yang berukuran 8 mm. Baut yang lebih panjang dapat merusak unit.

TROUBLESHOOTING

- **The fuse blows.**
 - * Are the red and black leads connected correctly?
- **Power cannot be turned on.**
 - * Is the yellow lead connected?
- **No sound from the speakers.**
 - * Is the speaker output lead short-circuited?
- **Sound is distorted.**
 - * Is the speaker output lead grounded?
 - * Are the “-” terminals of L and R speakers grounded in common?
- **Noise interfere with sounds.**
 - * Is the rear ground terminal connected to the car’s chassis using shorter and thicker cords?
- **Unit becomes hot.**
 - * Is the speaker output lead grounded?
 - * Are the “-” terminals of L and R speakers grounded in common?

PEMECAHAN MASALAH

- **Sekering terbakar.**
 - * Periksa apakah kabel merah dan hitam telah tersambung dengan benar?
- **Unit tidak dapat dinyalakan.**
 - * Periksa apakah kabel kuning telah tersambung?
- **Tidak ada suara dari speaker.**
 - * Periksa apakah ada korsleting pada kabel speaker?
- **Suara tidak jelas.**
 - * Periksa apakah output speaker telah di-ground-kan?
 - * Periksa apakah terminal “-” pada speaker kiri dan kanan telah di-ground-kan?
- **Derau yang menyertai suara.**
 - * Apakah terminal ground di belakang unit terhubung ke sasis mobil yang menggunakan kabel tipis dan pendek?
- **Unit menjadi panas.**
 - * Periksa apakah speaker output telah di-ground-kan?
 - * Periksa apakah terminal “-” pada speaker kiri dan kanan telah di-ground-kan?

ELECTRICAL CONNECTIONS

To prevent short circuits, we recommend that you disconnect the battery's negative terminal and make all electrical connections before installing the unit.

• **Be sure to ground this unit to the car's chassis again after installation.**

Notes:

- Replace the fuse with one of the specified rating. If the fuse blows frequently, consult your JVC car audio dealer.
- Maximum input of the speakers should be more than 45 W at the rear and 45 W at the front, with an impedance of **4 Ω to 8 Ω**.
- To prevent short-circuit, cover the terminals of the UNUSED leads with insulating tape.
- The heat sink becomes very hot after use. Be careful not to touch it when removing this unit.

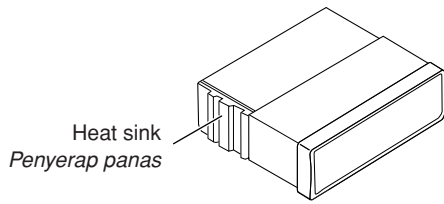

PENYAMBUNGAN LISTRIK

Untuk mencegah terjadinya korsleting, sangat dianjurkan apabila anda mencabut terminal baterai negatif dan memasang semua sambungan listrik sebelum memasang unit.

• **Yakinkan kembali ground dari unit ini apakah sudah terpasang atau belum setelah instalasi selesai.**

Catatan:

- Ganti sekering dengan sekering lain yang sesuai dengan syarat spesifikasi. Jika sekering sering terbakar, tanyakan pada dealer audio mobil JVC.
- Input maksimum speaker sebaiknya lebih dari 45 W pada bagian belakang dan 45 W pada bagian depan dengan impedansi antara **4 Ω sampai 8 Ω**.
- Untuk mencegah terjadinya korsleting, tutup ujung kabel yang tidak TERPAKAI dengan pita insulator.
- Penyerap panas akan menjadi sangat panas setelah pemakaian. Berhati-hatilah untuk tidak menyentuhnya saat memindahkan unit ini.

A Typical Connections/Penyambungan Khusus

Before connecting: Check the wiring in the vehicle carefully. Incorrect connection may cause serious damage to this unit.

The leads of the power cord and those of the connector from the car body may be different in color.

- 1 Connect the colored leads of the power cord in the order specified in the illustration below.
- 2 Connect the antenna cord.
- 3 Finally connect the wiring harness to the unit.

Sebelum menghubungkan listrik: Periksa kabel-kabel dalam peralatan anda dengan hati-hati. Hubungan yang salah dapat menyebabkan kerusakan serius pada unit ini.

Kabel dalam kabel listrik dan juga konektor kendaraan memiliki warna yang berlainan.

- 1 Hubungkan petunjuk warna pada kabel power dalam urutan yang ditunjukkan pada ilustrasi di bawah.
- 2 Sambungkan kabel antena.
- 3 Sambungkan sarung kabel dengan unit.

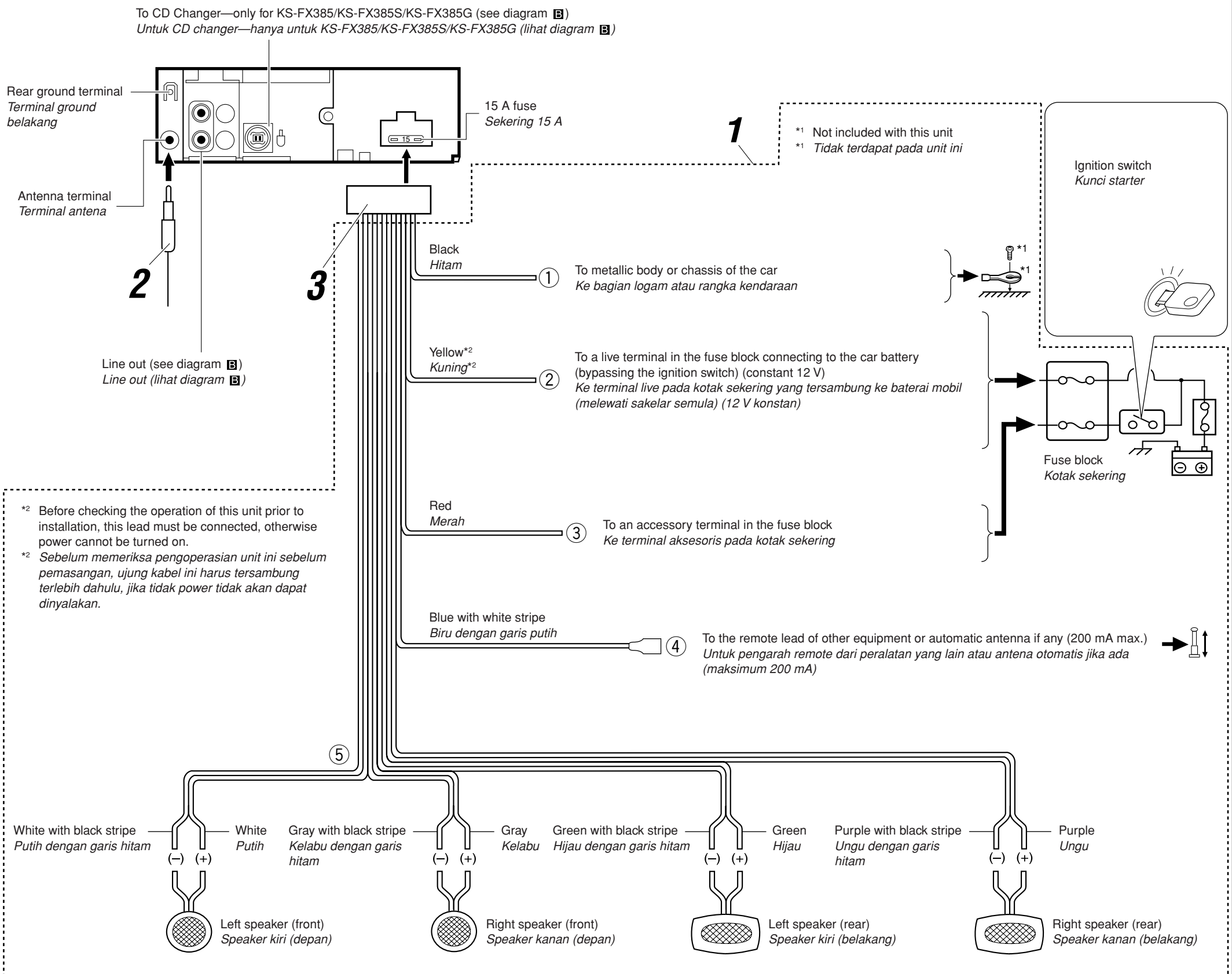

B Connections Adding Other Equipment/Sambungan pada peralatan lain

Amplifier/Amplifier

You can connect an amplifier to upgrade your car stereo system.

- Connect the remote lead (blue with white stripe) to the remote lead of the other equipment so that it can be controlled through this unit.
- **Disconnect the speakers from this unit, connect them to the amplifier. Leave the speaker leads of this unit unused.**

Anda dapat menghubungkan sebuah penguat suara untuk meningkatkan sistem stereo mobil anda.

- Sambungkan ujung kabel remote (biru dengan garis putih) dengan ujung kabel remote peralatan lain sehingga peralatan lain tersebut dapat dikontrol melalui unit ini.
- **Cabut speaker dari sistem dan sambungkan pada amplifier. Biarkan ujung speaker yang tidak terpakai.**

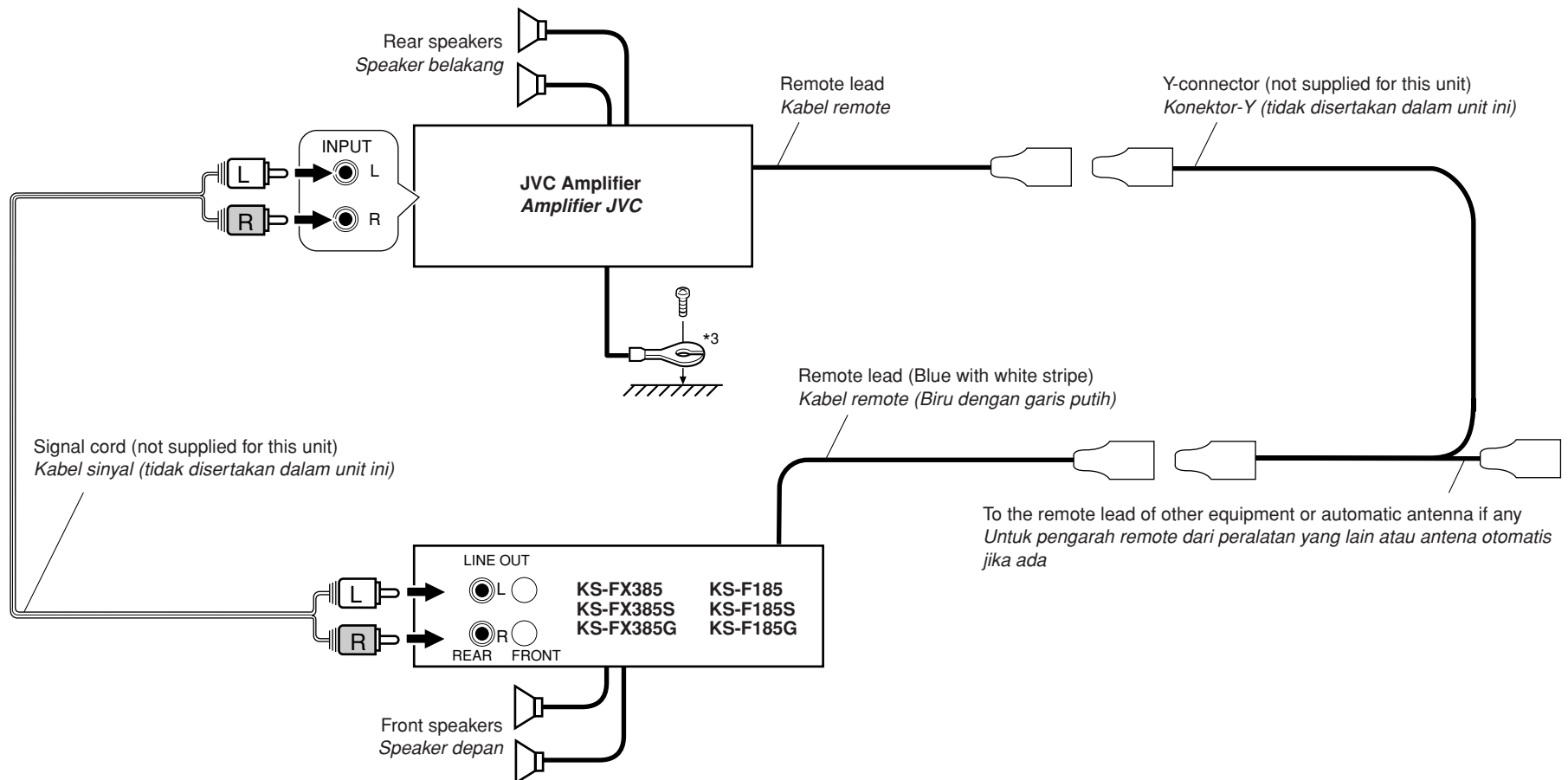

*3 Firmly attach the ground wire to the metallic body or to the chassis of the car—to the place not coated with paint (if coated with paint, remove the paint before attaching the wire). Failure to do so may cause damage to the unit.

*3 Pasanglah dengan ketat kabel ground ke bagian logam atau rangka kendaraan—dengan bagian yang tidak tertutupi oleh cat (apabila tertutup oleh cat, buanglah cat sebelum memasang kabel). Bila tidak dibuang, dapat mengakibatkan kerusakan serius.

CD Changer/CD changer

Only for KS-FX385/KS-FX385S/KS-FX385G/Hanya untuk KS-FX385/KS-FX385S/KS-FX385G

Refer also to page 13 of the INSTRUCTIONS.
Lihat juga ke halaman 13 dari BUKU PETUNJUK.

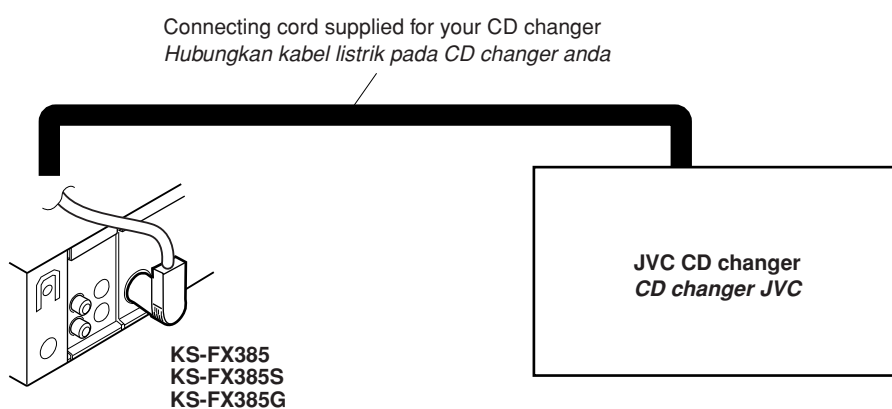

CAUTION/PERHATIKAN

- Before connecting the CD changer, make sure that the unit is turned off.
- *Sebelum CD changer dihubungkan pada sumber listrik, pastikan unit tersebut dalam keadaan mati.*

PRECAUTIONS on power supply and speaker connections:

- **DO NOT** connect the speaker leads of the power cord to the car battery; otherwise, the unit will be seriously damaged.
- **BEFORE** connecting the speaker leads of the power cord to the speakers, check the speaker wiring in your car.

PENCEGAHAN pada power supply dan sambungan speaker:

- **JANGAN** sambung ujung kabel speaker dengan baterai mobil. Hal ini dapat mengakibatkan kerusakan serius pada unit.
- **SEBELUM** menyambung ujung kabel speaker dengan speaker, periksa dulu sistem pengkabelan kendaraan anda.

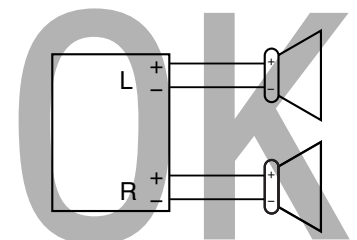
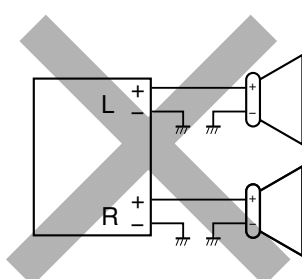
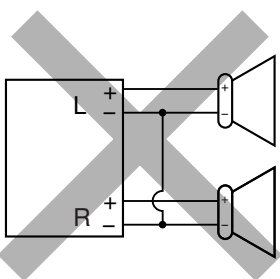

Free Manuals Download Website

<http://myh66.com>

<http://usermanuals.us>

<http://www.somanuals.com>

<http://www.4manuals.cc>

<http://www.manual-lib.com>

<http://www.404manual.com>

<http://www.luxmanual.com>

<http://aubethermostatmanual.com>

Golf course search by state

<http://golfingnear.com>

Email search by domain

<http://emailbydomain.com>

Auto manuals search

<http://auto.somanuals.com>

TV manuals search

<http://tv.somanuals.com>