

JVC



ENGLISH

DEUTSCH

FRANÇAIS

NEDERLANDS

CASSETTE RECEIVER
CASSETTEN-RECEIVER
RADIOCASSETTE
RADIO/CASSETTESPELER

KS-FX43R/KS-FX483R/KS-FX480R **KS-F383R/KS-F380R**

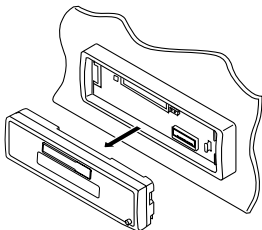

KS-FX43R/KS-FX483R/KS-FX480R

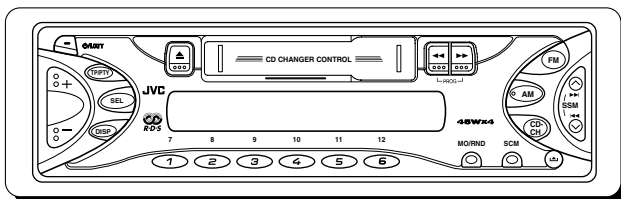

KS-F383R/KS-F380R

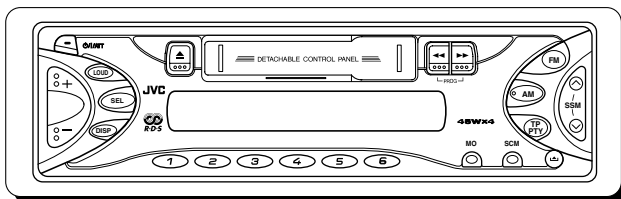

For installation and connections, refer to the separate manual.

Für den Einbau und die Anschlüsse siehe das eigenständige Handbuch.

Pour l'installation et les raccordements, se référer au manuel séparé.

Bijzonderheden over de installatie en aansluiting van het apparaat vindt u in de desbetreffende handleiding.

INSTRUCTIONS **BEDIENUNGSANLEITUNG** **MANUEL D'INSTRUCTIONS** **GEBRUIKSAANWIJZING**

GET0110-001A
[E/EX]

Thank you for purchasing a JVC product. Please read all instructions carefully before operation, to ensure your complete understanding and to obtain the best possible performance from the unit.

CONTENTS

How to reset your unit	2	SOUND ADJUSTMENTS	19
LOCATION OF THE BUTTONS	3	Adjusting the sound	19
Control panel—KS-FX43R/KS-FX483R/ KS-FX480R	3	Selecting preset sound modes	20
Control panel—KS-F383R/KS-F380R	4	Storing your own sound adjustments	20
BASIC OPERATIONS	5	OTHER MAIN FUNCTIONS	21
Turning on the power	5	Selecting the telephone muting	21
Setting the clock	6	Selecting the CD changer display	21
RADIO OPERATIONS	7	Detaching the control panel	23
Listening to the radio	7	CD CHANGER OPERATIONS (ONLY FOR KS-FX43R/KS-FX483R/KS-FX480R) ...	24
Storing stations in memory	9	Playing CDs	24
Tuning in to a preset station	10	Selecting CD playback modes	25
RDS OPERATIONS	11	MAINTENANCE	26
What you can do with RDS	11	TROUBLESHOOTING	27
Other convenient RDS functions and adjustments	15	SPECIFICATIONS	29
TAPE OPERATIONS	18		
Listening to a cassette	18		

How to reset your unit

While holding SEL (select), press ϕ /I/ATT (standby/on/attenuator) for more than 2 seconds. This will reset the built-in microcomputer.

Note:

Your preset adjustments—such as preset channels or sound adjustments—will also be erased.

ϕ /I/ATT (standby/on/attenuator)

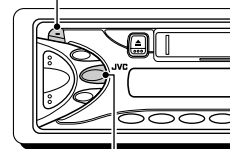

SEL (select)

Note:

For security reasons, a numbered ID card is provided with this unit, and the same ID number is imprinted on the unit's chassis. Keep the card in a safe place, as it will help the authorities to identify your unit if stolen.

BEFORE USE

*For safety....

- Do not raise the volume level too much, as this will block outside sounds, making driving dangerous.
- Stop the car before performing any complicated operations.

*Temperature inside the car....

If you have parked the car for a long time in hot or cold weather, wait until the temperature in the car becomes normal before operating the unit.

LOCATION OF THE BUTTONS



Control panel—KS-FX43R/KS-FX483R/KS-FX480R

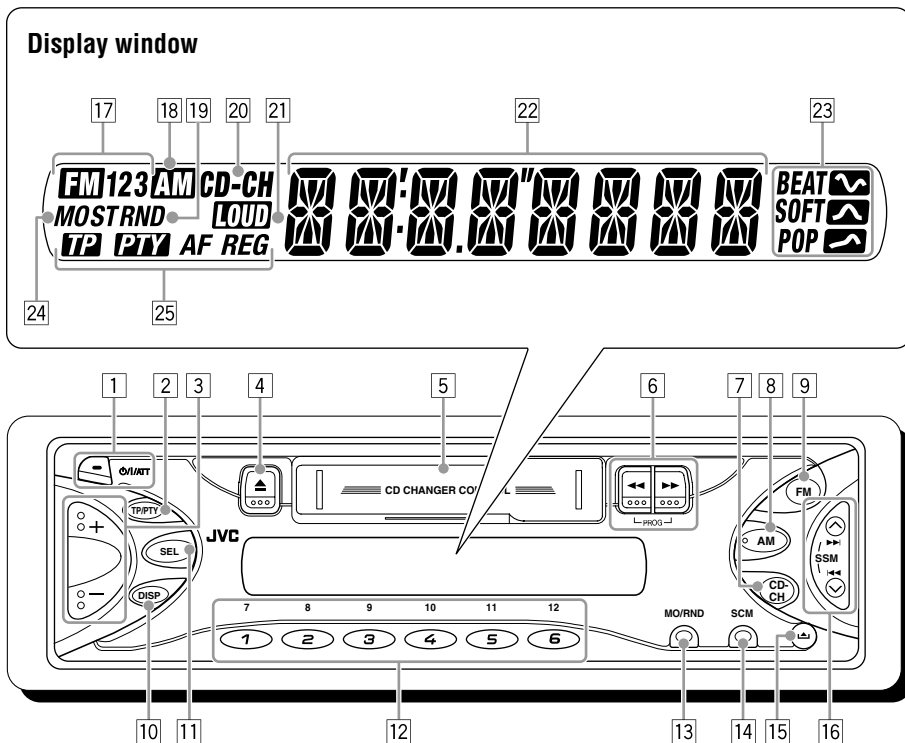

- 1 Φ /I/ATT (standby/on/attenuator) button
- 2 TP/PTY (traffic programme/programme type) button
- 3 +/- buttons
- 4 \blacktriangle (eject) button
- 5 Cassette compartment
- 6 \blacktriangleleft / \blacktriangleright (PROG: program) buttons
- 7 CD-CH (CD changer) button
- 8 AM button
- 9 FM button
- 10 DISP (display) button
- 11 SEL (select) button
- 12 Number buttons
- 13 MO/RND (monaural/random) button
- 14 SCM (sound control memory) button
- 15 \blacktriangle (control panel release) button
- 16 \blacktriangle \blacktriangleright / \blacktriangleleft \blacktriangledown buttons

• Also functions as SSM buttons when pressed together.

Display window

- 17 FM band indicators (FM1, FM2, FM3)
- 18 AM band indicator
- 19 RND (random) indicator
- 20 CD-CH (CD changer) indicator
- 21 LOUD (loudness) indicator
- 22 Main display
- 23 Sound mode indicators BEAT, SOFT, POP
- 24 Tuner reception indicators MO (monaural), ST (stereo)
- 25 RDS indicators TP, PTY, AF, REG

Control panel—KS-F383R/KS-F380R

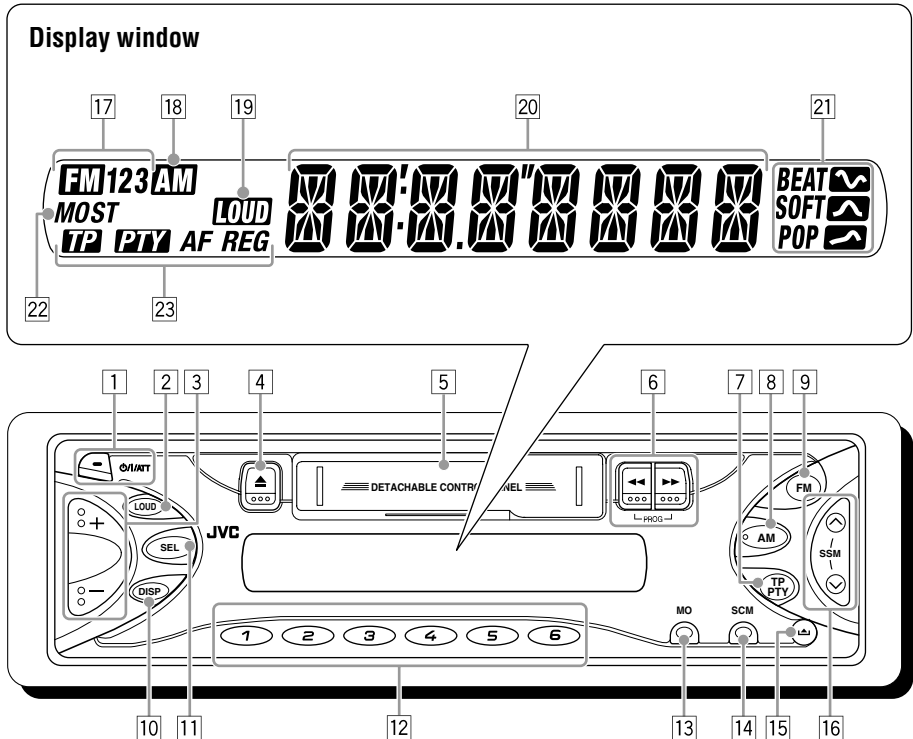

- 1 Φ /I/ATT (standby/on/attenuator) button
- 2 LOUD (loudness) button
- 3 +/- buttons
- 4 \blacktriangle (eject) button
- 5 Cassette compartment
- 6 $\blacktriangleleft\blacktriangleright$ (PROG: program) buttons
- 7 TP/PTY (traffic programme/programme type) button
- 8 AM button
- 9 FM button
- 10 DISP (display) button
- 11 SEL (select) button
- 12 Number buttons
- 13 MO (monaural) button
- 14 SCM (sound control memory) button
- 15 \blacktriangle (control panel release) button
- 16 $\blackwedge/\blacktriangledown$ buttons

- Also functions as SSM buttons when pressed together.

Display window

- 17 FM band indicators (FM1, FM2, FM3)
- 18 AM band indicator
- 19 LOUD (loudness) indicator
- 20 Main display
- 21 Sound mode indicators BEAT, SOFT, POP
- 22 Tuner reception indicators MO (monaural), ST (stereo)
- 23 RDS indicators TP, PTY, AF, REG

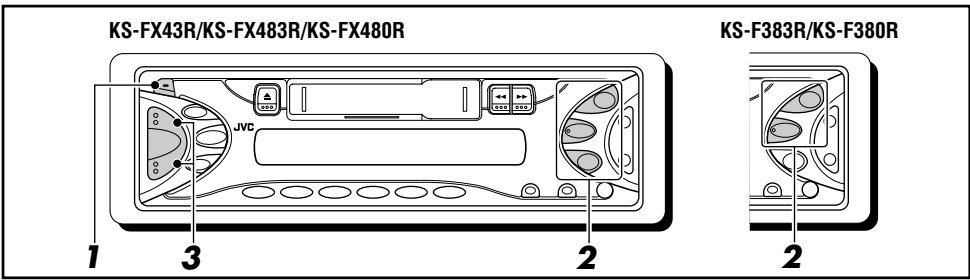

Turning on the power

1 Turn on the power.



Notes on One-Touch Operation:

- When you select a source in step 2 below, the power automatically comes on. You do not have to press this button to turn on the power.
- If the cassette is already in the cassette compartment, tape play starts automatically. However, it is not recommended to leave the cassette in the compartment when turning off the power or ignition key. It may damage the tape head and the cassette.

2 Select the source.



**KS-FX43R/
KS-FX483R/KS-FX480R**

KS-F383R/KS-F380R

To operate the tuner (FM or AM),
see pages 7 – 17.

To operate the tape,
see page 18.

Only for KS-FX43R/KS-FX483R/KS-FX480R:

To operate the CD changer,
see pages 24 – 25.

3 Adjust the volume.

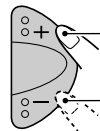

To increase the volume

To decrease the volume

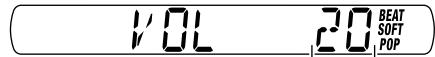

Volume level appears.

4 Adjust the sound as you want. (See pages 19 – 20.)

To drop the volume in a moment

Press **O/I/ATT** briefly while listening to any source. "ATT" starts flashing on the display, and the volume level will drop in a moment.

To resume the previous volume level, press the button briefly again.

To turn off the power

Press and hold **O/I/ATT** for more than one second.

"SEE YOU" appears, then the unit turns off.

Only for KS-FX43R

KS-FX43R is equipped with the steering wheel remote control function.

If your car is equipped with the steering wheel remote controller, you can operate this receiver using the controller.

- See the Installation/Connection Manual (separate volume) for connection to utilize this function.

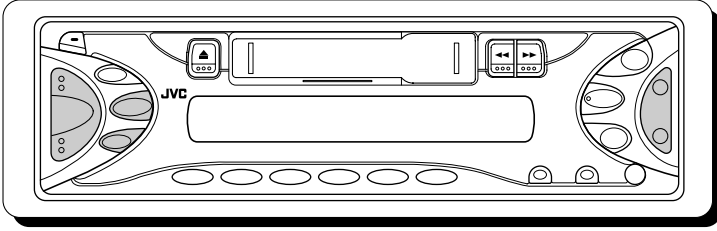

Setting the clock

You can also set the clock system to either 24 hours or 12 hours.

- 1 Press and hold SEL (select) for more than 2 seconds so that one of the PSM items appears on the display. (PSM: see page 22.)



- 2 Set the hour.

- 1 Select "CLOCK H" (hour) if not shown on the display.

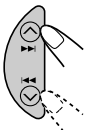

KS-FX43R
KS-FX483R
KS-FX480R

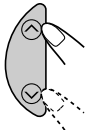

KS-F383R
KS-F380R

- 2 Adjust the hour.

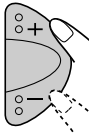

- 3 Set the minute.

- 1 Select "CLOCK M" (minute).

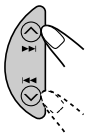

KS-FX43R
KS-FX483R
KS-FX480R

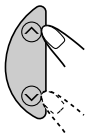

KS-F383R
KS-F380R

- 2 Adjust the minute.

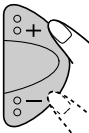

- 4 Set the clock system.

- 1 Select "24H/12H."

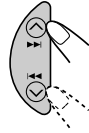

KS-FX43R
KS-FX483R
KS-FX480R

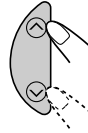

KS-F383R
KS-F380R

- 2 Select "24H" or "12H."

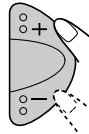

- 5 Finish the setting.



To check the current clock time or change the display mode



Press DISP (display) repeatedly.

Each time you press the button, the display mode and clock time alternates on the display.

Notes:

- For the indication change during RDS operation, see page 16.
- During CD changer operation (for KS-FX43R/ KS-FX483R/ KS-FX480R), see page 24.

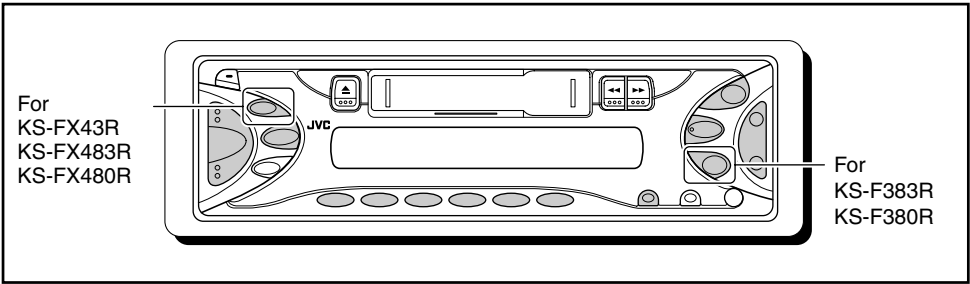

Listening to the radio

You can use either automatic searching or manual searching to tune in to a particular station.

Note:

When a cassette is in the cassette compartment, you cannot select the tuner. Be sure to eject the cassette from the cassette compartment to listen to the radio.

Searching a station automatically: Auto search

1 Select the band (FM1 – 3, AM).

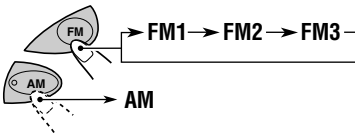

Selected band appears.

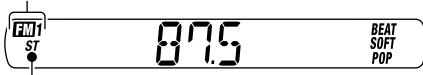

Lights up when receiving an FM stereo broadcast with sufficient signal strength.

Note:

This receiver has three FM bands (FM1, FM2, FM3). You can use any one of them to listen to an FM broadcast.

2 Start searching a station.

To search stations of higher frequencies

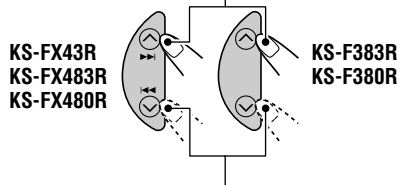

To search stations of lower frequencies

When a station is received, searching stops.

To stop searching before a station is received, press the same button you have pressed for searching.



Searching a station manually: Manual search

1 Select the band (FM1 – 3, AM).

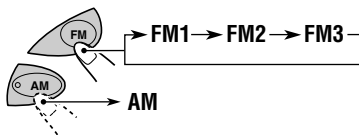

Note:

This receiver has three FM bands (FM1, FM2, FM3). You can use any one of them to listen to an FM broadcast.

2 Press and hold \wedge $\triangleright \triangleright \triangleright$ / $\mid \ll \ll \vee$ (for KS-FX43R/KS-FX483R/KS-FX480R) or \wedge / \vee (for KS-F383R/KS-F380R) until “M” (manual) starts flashing on the display.

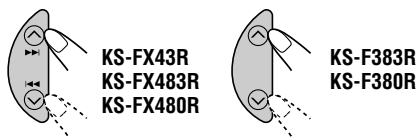

3 Tune in to a station you want while “M” is flashing.

To tune in to stations of higher frequencies

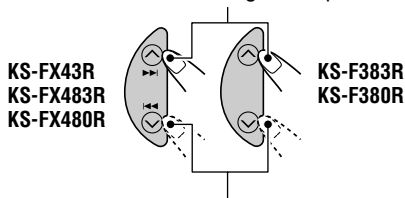

To tune in to stations of lower frequencies

- If you release your finger from the button, the manual mode will automatically turn off after 5 seconds.
- If you hold down the button, the frequency keeps changing (in 50 kHz intervals for FM and 9 kHz intervals for AM—MW/LW) until you release the button.

When an FM stereo broadcast is hard to receive:

Press MO/RND (for KS-FX43R/KS-FX483R/KS-FX480R) or MO (for KS-F383R/KS-F380R) while listening to an FM stereo broadcast.

- Each time you press the button, the MO indicator lights up and goes off alternately.

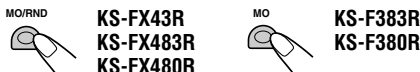

MO (monaural) indicator

When the MO indicator is lit on the display, the sound you hear becomes monaural but the reception will be improved.

Storing stations in memory

You can use one of the following two methods to store broadcasting stations in memory.

- Automatic preset of FM stations: SSM (Strong-station Sequential Memory)
- Manual preset of both FM and AM stations

FM station automatic preset: SSM

You can preset 6 local FM stations in each FM band (FM1, FM2, and FM3).

- 1** Select the FM band (FM1 – 3) you want to store FM stations into.

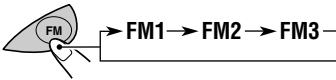

- 2** Press and hold both buttons for more than 2 seconds.

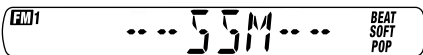
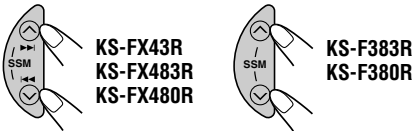

"-SSM-" appears, then disappears when automatic preset is over.

Local FM stations with the strongest signals are searched and stored automatically in the band number you have selected (FM1, FM2, or FM3). These stations are preset in the number buttons—No.1 (lowest frequency) to No.6 (highest frequency). When automatic preset is over, the station stored in number button 1 will be automatically tuned in.

Manual preset

You can preset up to 6 stations in each band (FM1, FM2, FM3, and AM) manually.

Ex.: Storing FM station of 88.3 MHz into the preset number 1 of the FM1 band.

- 1** Select the band (FM1 – 3, AM) you want to store stations into (in this example, FM1).

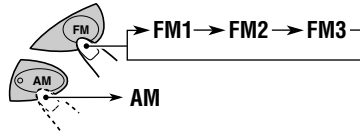

- 2** Tune in to a station (in this example, of 88.3 MHz).

To tune in to stations of higher frequencies

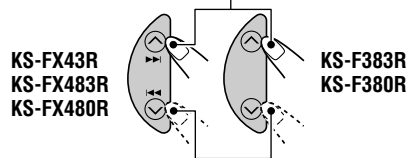

To tune in to stations of lower frequencies





3 Press and hold the number button (in this example, 1) for more than 2 seconds.



"P1" flashes for a few seconds.

4 Repeat the above procedure to store other stations into other preset numbers.

Notes:

- A previously preset station is erased when a new station is stored in the same preset number.
- Preset stations are erased when the power supply to the memory circuit is interrupted (for example, during battery replacement). If this occurs, preset the stations again.

Tuning in to a preset station

You can easily tune in to a preset station. Remember that you must store stations first. If you have not stored them yet, see "Storing stations in memory" on pages 9 and 10.

1 Select the band (FM1 – 3, AM).

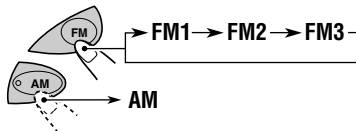

2 Select the number (1 – 6) for the preset station you want.

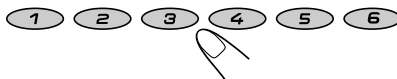



What you can do with RDS

RDS (Radio Data System) allows FM stations to send an additional signal along with their regular programme signals. For example, the stations send their station names, as well as information about what type of programme they broadcast, such as sports or music, etc.

Another advantage of RDS function is called "Enhanced Other Networks." By using the Enhanced Other Networks data sent from a station, you can tune in to a different station of a different network broadcasting your favorite programme or traffic announcement while listening to another programme or to another source such as tape.

By receiving the RDS data, this unit can do the following:

- Tracing the same programme automatically (Network-Tracking Reception)
- Standby Reception of TA (Traffic Announcement) or your favorite programme
- PTY (Programme Type) search
- Programme search
- And some other functions

Tracing the same programme automatically (Network-Tracking Reception)

When driving in an area where FM reception is not good, the tuner built in this unit automatically tunes in to another RDS station, broadcasting the same programme with stronger signals. So, you can continue to listen to the same programme in its finest reception, no matter where you drive. (See the illustration on page 17.)

Two types of the RDS data are used to make Network-Tracking Reception work correctly—PI (Programme Identification) and AF (Alternative Frequency).

Without receiving these data correctly from the RDS station you are listening to, Network-Tracking Reception will not operate.

To use Network-Tracking Reception

You can select the different modes of network-tracking reception to continue listening to the same programme in its finest reception. When shipped from the factory, "AF" is selected.

- **AF:** Network-Tracking Reception is activated with Regionalization set to "off." With this setting, the unit switches to another station within the same network when the receiving signals from the current station become weak. (In this mode, the programme may differ from the one currently received.) The AF indicator lights up but the REG indicator does not.
- **AF REG:** Network-Tracking Reception is activated with Regionalization set to "on." With this setting, the unit switches to another station, within the same network, broadcasting the same programme when the receiving signals from the current station become weak. Both the AF indicator and the REG indicator light up.
- **OFF:** Network-Tracking Reception is deactivated. Neither the AF indicator nor the REG indicator lights up.

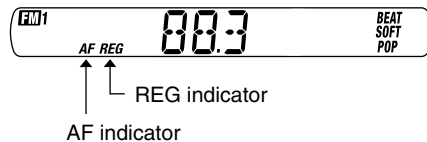

CONTINUED ON THE NEXT PAGE



1 Press and hold SEL (select) for more than 2 seconds so that one of the PSM items appears on the display. (PSM: see page 22.)



2 Select “AF-REG” (alternative frequency/regionalization reception) if not shown on the display.

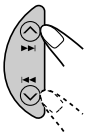

KS-FX43R
KS-FX483R
KS-FX480R

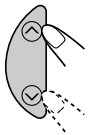

KS-F383R
KS-F380R

3 Select the desired mode—“AF,” “AF REG,” or “OFF.”

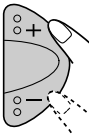

4 Finish the setting.



Using TA Standby Reception

TA Standby Reception allows the unit to switch temporarily to Traffic Announcement (TA) from the current source—another FM station, tape, or other connected components (for KS-FX43R/ KS-FX483R/KS-FX480R).

- *TA Standby Reception will not work if you are listening to an AM station.*

Press TP/PTY to activate TA Standby Reception.



KS-FX43R
KS-FX483R
KS-FX480R



KS-F383R
KS-F380R

■ **When the current source is FM,** the TP indicator either lights up or flashes.

- If the TP indicator lights up, TA Standby Reception is activated.

If a station starts broadcasting a traffic announcement, “TRAFFIC” appears on the display, and this unit automatically tunes in to the station. The volume changes to the preset TA volume level (see page 16) and the traffic announcement can be heard.

- If the TP indicator flashes, TA Standby Reception is not yet activated since the station being received does not provide the signals used for TA Standby Reception. To activate TA Standby Reception, you need to tune in to another station providing these signals.

Press \blacktriangle \blacktriangleright \blacktriangleleft \blacktriangleleft \blacktriangledown (for KS-FX43R/ KS-FX483R/KS-FX480R) or \blacktriangle \blacktriangledown (for KS-F383R/KS-F380R) to search for such a station.

When a station providing these signals is tuned in, the TP indicator stops flashing and remains lit. Now TA Standby Reception is activated.

■ **When the current source is other than FM,** the TP indicator lights up.

If a station starts broadcasting a traffic announcement, “TRAFFIC” appears on the display, and this unit automatically changes the source and tunes in to the station.

To deactivate the TA Standby Reception, press TP/PTY again.



Using PTY Standby Reception

PTY Standby Reception allows the unit to switch temporarily to your favorite programme (PTY: Programme Type) from the current source—another FM station, tape, or other connected components (for KS-FX43R/KS-FX483R/KS-FX480R).

- *PTY Standby Reception will not work if you are listening to an AM station.*

You can select your favorite programme type for PTY Standby Reception.

When shipped from the factory, PTY Standby Reception is turned off. ("OFF" is selected for PTY Standby Reception.)

- 1 Press and hold SEL (select) for more than 2 seconds so that one of the PSM items appears on the display. (PSM: see page 22.)**



- 2 Select "PTY STBY" (standby) if not shown on the display.**

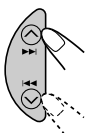

KS-FX43R
KS-FX483R
KS-FX480R

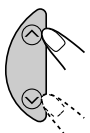

KS-F383R
KS-F380R

- 3 Select one of the twenty-nine PTY codes. (See page 17.)**

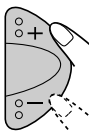

Selected code name appears on the display and is stored into memory.

- 4 Finish the setting.**



■ **When the current source is FM**, the PTY indicator either lights up or flashes.

- **If the PTY indicator lights up**, PTY Standby Reception is activated.

If a station starts broadcasting the selected PTY programme, this unit automatically tunes in to the station.

- **If the PTY indicator flashes**, PTY Standby Reception is not yet activated since the station being received does not provide the signals used for PTY Standby Reception.

To activate PTY Standby Reception, you need to tune in to another station providing these signals.

Press \blacktriangle \blacktriangleright / \blacktriangleleft \blacktriangledown (for KS-FX43R/KS-FX483R/KS-FX480R) or \blacktriangle / \blacktriangledown (for KS-F383R/KS-F380R) to search for such a station.

When a station providing these signals is tuned in, the PTY indicator stops flashing and remains lit. Now PTY Standby Reception is activated.

■ **When the current source is other than FM**, the PTY indicator lights up.

If a station starts broadcasting the selected PTY programme, this unit automatically changes the source and tunes in to the station.

To deactivate the PTY Standby Reception, select "OFF" in step 3 on the left column. The PTY indicator disappears.



Searching your favorite programme

You can search any one of the PTY codes. In addition, you can store your 6 favorite programme types in the number buttons. When shipped from the factory, the following 6 programme types have been stored in the number buttons (1 to 6).

To store your favorite programme types, see below.

To search your favorite programme type, see page 15.

1	2	3
POP M	ROCK M	EASY M
4	5	6
CLASSICS	AFFAIRS	VARIED

To store your favorite programme types

1 Press and hold TP/PTY for more than 2 seconds while listening to an FM station.



The last selected PTY code appears.

2 Select one of the twenty-nine PTY codes. (See page 17.)

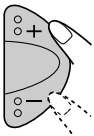

Selected code name appears on the display.

3 Press and hold the number button for more than 2 seconds to store the PTY code selected into the preset number you want.

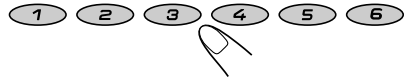

“MEMORY” and the selected code name will flash alternately on the display.

4 Press and hold TP/PTY for more than 2 seconds to exit from this mode.



To search your favorite programme type

- 1** Press and hold TP/PTY for more than 2 seconds while listening to an FM station.



KS-FX43R
KS-FX483R
KS-FX480R



KS-F383R
KS-F380R



The last selected PTY code appears.

- 2** To select one of your favorite programme type

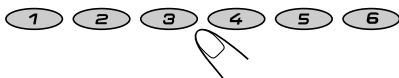

or

To select any one of the twenty-nine PTY-codes

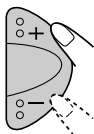

Ex.: When "ROCK M" is selected

- 3** Press \wedge \triangleright \triangleright \triangleright / \triangleright \llcorner \llcorner \llcorner \vee (for KS-FX43R/ KS-FX483R/ KS-FX480R) or \wedge / \vee (for KS-F383R/ KS-F380R) to start PTY search for your favorite programme.

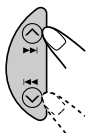

KS-FX43R
KS-FX483R
KS-FX480R

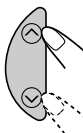

KS-F383R
KS-F380R

- If there is a station broadcasting a programme of the same PTY code as you selected, that station is tuned in.
- If there is no station broadcasting a programme of the same PTY code as you selected, the station will not change.

Note:

In some areas, the PTY search will not work correctly.

Other convenient RDS functions and adjustments

Automatic selection of the station when using the number buttons

Usually when you press the number button, the preset station is tuned in. However, when the preset station is an RDS station, something different will happen. If the signals from that preset station are not sufficient for good reception, this unit, using the AF data, tunes in to another frequency broadcasting the same programme as the original preset station is broadcasting. (Programme search)

- The unit takes some time to tune in to another station using programme search.

To activate programme search, follow the procedure below.

- 1 Press and hold SEL (select) for more than 2 seconds so that one of the PSM items appears on the display. (See page 22.)
- 2 Press \wedge \triangleright \triangleright \triangleright / \triangleright \llcorner \llcorner \llcorner \vee (for KS-FX43R/ KS-FX483R/ KS-FX480R) or \wedge / \vee (for KS-F383R/ KS-F380R) to select "P(Programme)-SEARCH."
- 3 Press + to select "ON."
Now programme search is activated.
- 4 Press SEL (select) to finish the setting.

To cancel programme search, repeat the same procedure and select "OFF" in step 3 by pressing -.



Changing the display mode while listening to an FM station

You can change the initial indication on the display to station name (PS NAME), station frequency (FREQ), or clock time (CLOCK) while listening to an FM RDS station.

- 1 Press and hold SEL (select) for more than 2 seconds so that one of the PSM items appears on the display. (See page 22.)
- 2 Press \blacktriangle \blacktriangleright / \blacktriangleleft \blacktriangleleft \blacktriangledown (for KS-FX43R/KS-FX483R/KS-FX480R) or \blacktriangle / \blacktriangledown (for KS-F383R/KS-F380R) to select "DISPMODE" (display mode).
- 3 Press + or - to set to the desired indication ("PS NAME," "FREQ," or "CLOCK").
- 4 Press SEL (select) to finish the setting.

Note:

By pressing DISP (display), you can change the display while listening to an FM RDS station. Each time you press the button, the following information appears on the display:

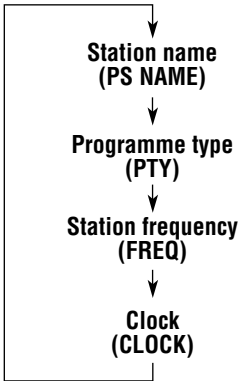

- Then, the display goes back to the original indication in several seconds.

Setting the TA volume level

You can preset the volume level for TA Standby Reception. When a traffic programme is received, the volume level automatically changes to the preset level.

- 1 Press and hold SEL (select) for more than 2 seconds so that one of the PSM items appears on the display. (See page 22.)
- 2 Press \blacktriangle \blacktriangleright / \blacktriangleleft \blacktriangleleft \blacktriangledown (for KS-FX43R/KS-FX483R/KS-FX480R) or \blacktriangle / \blacktriangledown (for KS-F383R/KS-F380R) to select "TA VOL" (volume).
- 3 Press + or - to set to the desired volume. You can set it from "VOL 00" to "VOL 50."
- 4 Press SEL (select) to finish the setting.

Automatic clock adjustment

When shipped from the factory, the clock built in this unit is set to be readjusted automatically using the CT (Clock Time) data in the RDS signal. If you do not want to use automatic clock adjustment, follow the procedure below.

- 1 Press and hold SEL (select) for more than 2 seconds so that one of the PSM items appears on the display. (See page 22.)
- 2 Press \blacktriangle \blacktriangleright / \blacktriangleleft \blacktriangleleft \blacktriangledown (for KS-FX43R/KS-FX483R/KS-FX480R) or \blacktriangle / \blacktriangledown (for KS-F383R/KS-F380R) to select "AUTO ADJ" (adjustment).
- 3 Press - to select "OFF". Now automatic clock adjustment is canceled.
- 4 Press SEL (select) to finish the setting.

To reactivate clock adjustment, repeat the same procedure and select "ON" in step 3 by pressing +.

Note:

You must stay tuned to the same station for more than 2 minutes after setting "AUTO ADJ" to "ON." Otherwise, the clock time will not be adjusted. (This is because the unit takes up to 2 minutes to capture the CT data in the RDS signal.)

PTY codes

NEWS:	News	CHILDREN:	Entertainment programmes for children
AFFAIRS:	Topical programmes expanding on current news or affairs	SOCIAL:	Programmes on social activities
INFO:	Programmes which impart advice on a wide variety of topics	RELIGION:	Programmes dealing with any aspect of belief or faith, or the nature of existence or ethics
SPORT:	Sport events	PHONE IN:	Programmes where people can express their views either by phone or in a public forum
EDUCATE:	Educational programmes	TRAVEL:	Programmes about travel destinations, package tours, and travel ideas and opportunities
DRAMA:	Radio plays	LEISURE:	Programmes concerned with recreational activities such as gardening, cooking, fishing, etc.
CULTURE:	Programmes on national or regional culture	JAZZ:	Jazz music
SCIENCE:	Programmes on natural science and technology	COUNTRY:	Country music
VARIED:	Other programmes like comedies or ceremonies	NATION M:	Current popular music from another nation or region, in that country's language
POP M:	Pop music	OLDIES:	Classic pop music
ROCK M:	Rock music	FOLK M:	Folk music
EASY M:	Easy-listening music	DOCUMENT:	Programmes dealing with factual matters, presented in an investigative style
LIGHT M:	Light music		
CLASSICS:	Classical music		
OTHER M:	Other music		
WEATHER:	Weather information		
FINANCE:	Reports on commerce, trading, the Stock Market, etc.		

The same programme can be received on different frequencies.

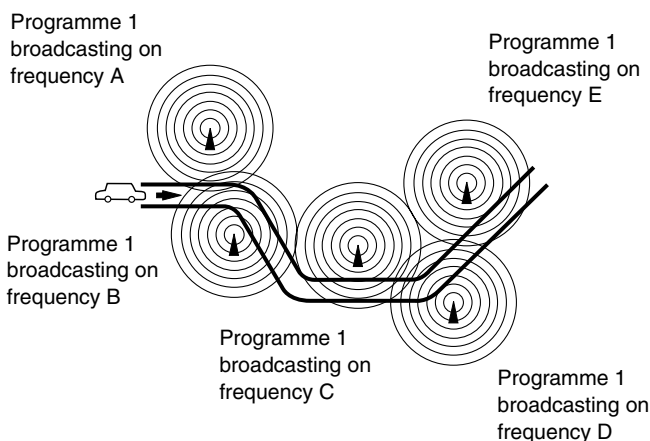



TAPE OPERATIONS

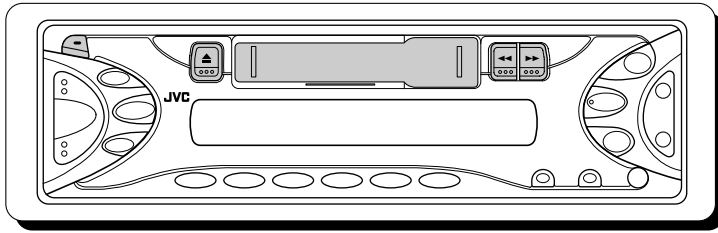

Listening to a cassette

You can play back type I (normal) tapes.

1 Turn on the power.



Note on One-Touch Operation:

If a cassette is already in the cassette compartment, tape play starts automatically. However, it is not recommended to leave the cassette in the compartment when turning off the power or ignition key. It may damage the tape head and the cassette.

2 Insert a cassette into the cassette compartment.

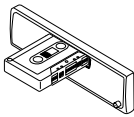

When one side of the tape reaches its end during play, the other side of the tape automatically starts playing (Auto Reverse).

3 Select the tape direction.



Press both buttons at the same time. Each time you press both buttons, the tape direction changes alternately—forward (TAPE >>>) and reverse (TAPE <<<).

To stop play and eject the cassette

Press ▲.

Tape play stops and the cassette ejects from the cassette compartment. The source changes to the previously selected one.

- You cannot change the source if the cassette is still in the cassette compartment. To change the source, you must eject the cassette first.
- You can also eject the cassette by pressing ▲ while the unit is turned off.

To fast-wind a tape

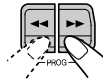

Press in >>> or <<<.

The tape will be wound in the direction of the arrows (>>> or <<<).



Tape direction



To restart playback, lightly press the other button which is not pressed in (<<< or >>>).



Adjusting the sound

You can adjust the sound characteristics to your preference.

1 Select the item you want to adjust.



Each time you press the button, the adjustable items change as follows:

For KS-FX43R/KS-FX483R/KS-FX480R:

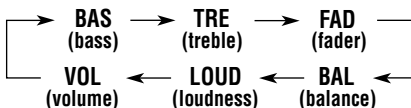

For KS-F383R/KS-F380R:

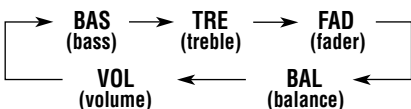

2 Adjust the setting.

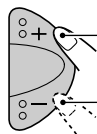

To increase the level or turn on the loudness

To decrease the level or turn off the loudness

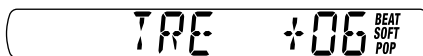

Ex.: When you adjust "TRE" (treble)

To turn on or off the loudness function

(For KS-F383R/KS-F380R)



Each time you press LOUD, the loudness function turns on and off alternately.

3 Repeat steps 1 and 2 to adjust the other items.

Note:

Normally the +/- buttons work as the volume control. So you do not have to select "VOL" to adjust the volume level.

Indication	To do:	Range
BAS	Adjust the bass.	-06 (min.) +06 (max.)
TRE	Adjust the treble.	-06 (min.) +06 (max.)
FAD*	Adjust the front and rear speaker balance.	R06 (Rear only) F06 (Front only)
BAL	Adjust the left and right speaker balance.	L06 (Left only) R06 (Right only)
LOUD**	Boost low and high frequencies to produce a well-balanced sound at low volume level.	LOUD ON LOUD OFF
VOL	Adjust the volume.	00 (min.) 50 (max.)

* If you are using a two-speaker system, set the fader level to "00."

** For KS-FX43R/KS-FX483R/KS-FX480R.

For KS-F383R/KS-F380R, press LOUD to turn on or off the loudness function.



Selecting preset sound modes

You can select a preset sound adjustment suitable to the music genre.

Select the sound mode you want.



Each time you press the button, the sound mode changes as follows:



Indication	For:	Preset values		
		BAS	TRE	LOUD
SCM OFF	(Flat sound)	00	00	OFF
BEAT	Rock or disco music	+02	00	ON
SOFT	Quiet background music	+01	-03	OFF
POP	Light music	+04	+01	OFF

Notes:

- You can adjust each sound mode to your preference, and store it in memory. If you want to adjust and store your original sound mode, see “Storing your own sound adjustments” that follows.
- To adjust the bass and treble reinforcement levels or to turn on/off the loudness function, see page 19.

Storing your own sound adjustments

You can adjust the sound modes (BEAT, SOFT, POP) to your preference and store your own adjustments in memory.

- There is a time limit in doing the following procedure. If the setting is canceled before you finish, start from step 1 again.

1 Call up the sound mode you want to adjust.



- See the left column for details.

2 Make adjustments.

- For details, see “Adjusting the sound” on page 19.

3 Repeat step 2 to adjust the other items.

4 Press and hold SCM until the sound mode you have selected in step 1 flashes on the display.



Your adjustment made for the selected sound mode is stored in memory.

5 Repeat the same procedure to store other sound modes.

To reset each sound mode to the factory settings, repeat the same procedure and reassign the preset values listed in the table on the left column.



Selecting the telephone muting

This mode is used when a cellular phone system is connected. Depending on the phone system used, select either "MUTING 1" or "MUTING 2," whichever mutes the sounds from this unit. When shipped from the factory, this mode is deactivated.

- 1 Press and hold SEL (select) for more than 2 seconds so that one of the PSM items appears on the display. (See page 22.)**



- 2 Select "TEL" (telephone muting).**

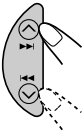

- 3 Select the desired mode—"MUTING 1," "MUTING 2," or "OFF."**

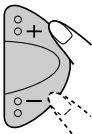

- MUTING 1: Select this if this setting can mute the sounds.
- MUTING 2: Select this if this setting can mute the sounds.
- OFF: Cancels the telephone muting.

- 4 Finish the setting.**



Selecting the CD changer display

Only for KS-FX43R/KS-FX483R/KS-FX480R.

You can change the initial indication on the display either to disc number or to elapsed playing time, while using the CD changer. When shipped from the factory, "DISC" is selected.

- 1 Press and hold SEL (select) for more than 2 seconds so that one of the PSM items appears on the display. (See page 22.)**



- 2 Select "CH DISP" (changer display).**

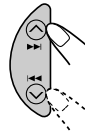

- 3 Select the desired mode—"DISC" or "TIME."**

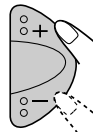

- DISC: Shows the disc number and track number.
- TIME: Shows the elapsed playing time and track number.

- 4 Finish the setting.**





Preferred Setting Mode (PSM) items

• For detailed operations of each PSM item, refer to the pages listed in the table.

1 Hold.		2 Select. KS-FX43R/KS-FX483R/ KS-FX480R		3 Set. 		Factory-preset settings	See page
				-	+		
CLOCK H	Hour adjustment	Back	Advance	0:00	6		
CLOCK M	Minute adjustment	Back	Advance				
24H/12H	24/12-hour time display	12H	24H	24H	6		
AUTO ADJ	Automatic clock setting	OFF	ON	ON	16		
DISPMODE	Display mode	CLOCK ↔ PS NAME 		PS NAME	16		
CH DISP*	Changer display	TIME	DISC	DISC	21		
AF-REG	Alternate frequency/ Regionalization reception	AF	AF REG	AF	11		
PTY STBY	PTY standby	OFF → 29 programme types (see page 17)		OFF	13		
TA VOL	Traffic announcement volume	VOL 00 – VOL 50		VOL 20	16		
P-SEARCH	Programme search	OFF	ON	OFF	15		
TEL	Telephone muting	MUTING 1 ↔ MUTING 2 		OFF	21		

• Press SEL (select) to finish the setting.

* Only for KS-FX43R/KS-FX483R/KS-FX480R.



Detaching the control panel

You can detach the control panel when leaving the car.
When detaching or attaching the control panel, be careful not to damage the connectors on the back of the control panel and on the panel holder.

Detaching the control panel

Before detaching the control panel, be sure to turn off the power.

1 Unlock the control panel.

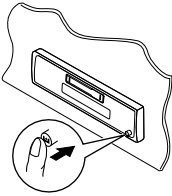

2 Lift and pull the control panel out of the unit.

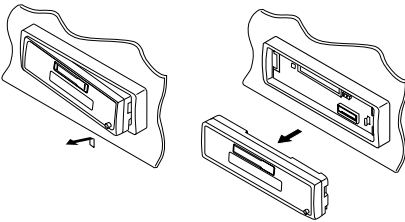

3 Put the detached control panel into the provided case.

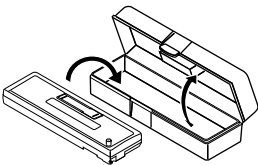

Attaching the control panel

1 Insert the left side of the control panel into the groove on the panel holder.

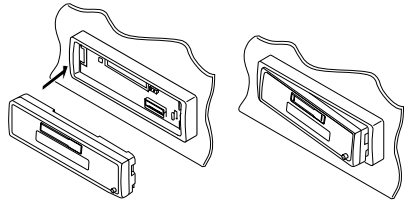

2 Press the right side of the control panel to fix it to the panel holder.

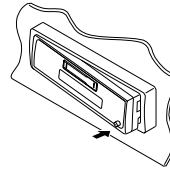

Note on cleaning the connectors:

If you frequently detach the control panel, the connectors will deteriorate.

To minimize this possibility, periodically wipe the connectors with a cotton swab or cloth moistened with alcohol, being careful not to damage the connectors.

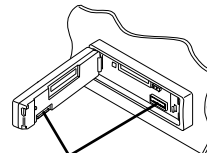

Connectors



CD CHANGER OPERATIONS

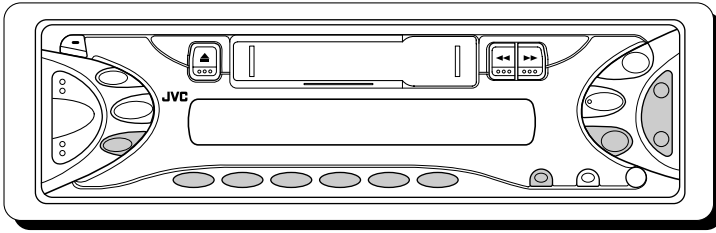

This section is only for KS-FX43R/KS-FX483R/ KS-FX480R.

We recommend that you use one of the CH-X series with your unit (except for JVC MP3-compatible CD changer).

If you have another CD changer, consult your JVC IN-CAR ENTERTAINMENT dealer for connections.

- For example, if your CD changer is one of the KD-MK series, you need a cord (KS-U15K) for connecting it to this unit.

Before operating your CD changer:

- Refer also to the Instructions supplied with your CD changer.
- If no discs are in the magazine of the CD changer or the discs are inserted upside down, "NO CD" will appear on the display. If this happens, remove the magazine and set the discs correctly.
- If no magazine is loaded in the CD changer, "NO MAG" appears on the display. If this happens, insert the magazine in the CD changer.
- If "RESET 1" – "RESET 8" appears on the display, something is wrong with the connection between this unit and the CD changer. If this happens, check the connection and make sure the cords are connected firmly. Then, press the reset button of the CD changer.

Playing CDs

Select the CD changer (CD-CH).



Playback starts from the first track of the first disc. All tracks of all discs will be played back.

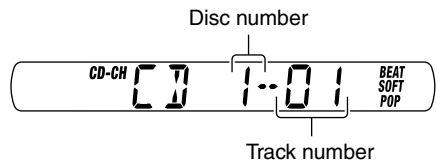

Note on One-Touch Operation:

When you press CD-CH, the power automatically turns on. You do not have to press /ATT to turn on the power.

To check the elapsed playing time



Press DISP (display) repeatedly. Each time you press the button, the display mode changes as follows:





To fast-forward or reverse the track

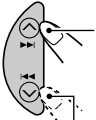

Press and hold **▲▶▶▶**, while playing a CD, to fast-forward the track.

Press and hold **◀◀◀▼**, while playing a CD, to reverse the track.

To go to the next or previous tracks

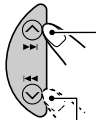

Press **▲▶▶▶** briefly, while playing a CD, to go ahead to the beginning of the next track.

Each time you press the button consecutively, the beginning of the next track is located and played back.

Press **◀◀◀▼** briefly, while playing a CD, to go back to the beginning of the current track.

Each time you press the button consecutively, the beginning of the previous tracks is located and played back.

To go to a particular disc directly

Press the number button corresponding to the disc number to start its playback (while the CD changer is playing).

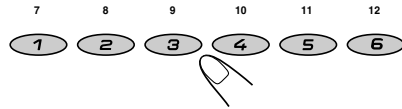

- To select a disc number from 1 – 6: Press 1 (7) – 6 (12) briefly.
- To select a disc number from 7 – 12: Press and hold 1 (7) – 6 (12) for more than one second.

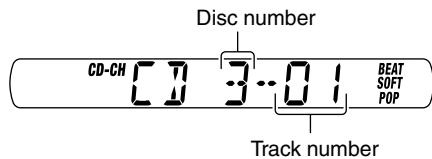

Ex.: When disc number 3 is selected.

Selecting CD playback modes

To play back tracks at random (Random Play)



Each time you press the button, CD random play mode changes as follows:



Mode	RND Indicator	Plays at random
RND1 (random1)	Lights	All tracks of the current disc, then the tracks of the next disc, and so on.
RND2 (random2)	Flashes	All tracks of all discs inserted in the magazine.



MAINTENANCE

This unit requires very little attention, but you will be able to extend the life of the unit if you follow the instructions below.

To clean the head

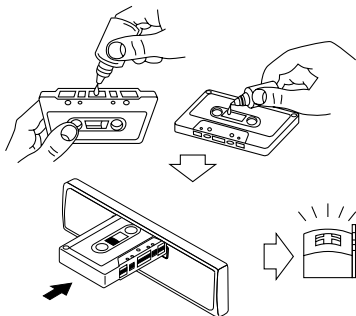

- Clean the head after every 10 hours of use using a wet-type head cleaning tape (available at an audio store).
When the head becomes dirty, you may realize the following symptoms:
 - Sound quality is reduced.
 - Sound level decreases.
 - Sound drops out.
- Do not play dirty or dusty tapes.
- Do not touch the highly-polished head with any metallic or magnetic tools.

To keep the tape clean

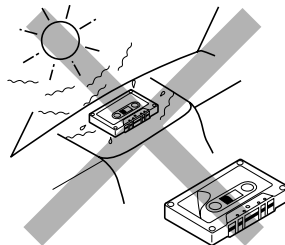

- Always store the cassettes to their storage cases after use.
- Do not store cassettes in the following places:
 - Subject to direct sunlight
 - With high humidity
 - At extremely hot temperatures

CAUTION:

- *Do not play the cassettes with peeling labels; otherwise, they can damage the unit.*
- *Tighten tapes to remove slack since loose tape may become entangled with the mechanism.*
- *Do not leave a cassette in the cassette compartment after use, as the tape may become slack.*

TROUBLESHOOTING



What appears to be trouble is not always serious. Check the following points before calling a service center.

	Symptoms	Causes	Remedies
General	• Sound is sometimes interrupted.	Connections are incorrect.	Check the cords and connections.
	• Sound cannot be heard from the speakers.	The volume is set to the minimum level.	Adjust it to the optimum level.
		Connections are incorrect.	Check the cords and connections.
	• The unit does not work at all.	The built-in microcomputer may function incorrectly due to noise, etc.	While holding SEL (select), press Φ /I/ATT (standby/on/attenuator) for more than 2 seconds to reset the unit. (The clock setting and preset stations stored in memory are erased.) (See page 2.)
FM/AM	• SSM (Strong-station Sequential Memory) automatic preset does not work.	Signals are too weak.	Store stations manually.
	• Static noise while listening to the radio.	The antenna is not connected firmly.	Connect the antenna firmly.
Tape playback	• A cassette tape cannot be inserted.	You have tried to insert a cassette in the wrong way.	Insert the cassette with the exposed tape facing right.
	• Cassette tapes become hot.	This is not a malfunction.	_____
	• Tape sound is at very low level and sound quality is degraded.	The tape head is dirty.	Clean it with a head cleaning tape.

**Only for KS-FX43R/KS-FX483R/KS-FX480R**

	Symptoms	Causes	Remedies
CD Changer	<ul style="list-style-type: none"> • “NO CD” appears on the display. 	No CD is in the magazine.	Insert CDs into the magazine.
		CDs are inserted incorrectly.	Insert them correctly.
	<ul style="list-style-type: none"> • “NO MAG” appears on the display. 	No magazine is loaded in the CD changer.	Insert the magazine.
	<ul style="list-style-type: none"> • “RESET 8” appears on the display. 	This unit is not connected to a CD changer correctly.	Connect this unit and the CD changer correctly and press the reset button of the CD changer.
	<ul style="list-style-type: none"> • “RESET 1” – “RESET 7” appears on the display. 	_____	Press the reset button of the CD changer.
<ul style="list-style-type: none"> • The CD changer does not work at all. 	The built-in microcomputer may function incorrectly due to noise, etc.	While holding SEL (select), press $\Phi/1/ATT$ (standby/on/attenuator) for more than 2 seconds to reset the unit. (The clock setting and preset stations stored in memory are erased.) (See page 2.)	

AUDIO AMPLIFIER SECTION

Maximum Power Output:

Front: 45 W per channel

Rear: 45 W per channel

Continuous Power Output (RMS):

Front: 17 W per channel into 4 Ω , 40 Hz to 20 000 Hz at no more than 0.8% total harmonic distortion.

Rear: 17 W per channel into 4 Ω , 40 Hz to 20 000 Hz at no more than 0.8% total harmonic distortion.

Load Impedance: 4 Ω (4 Ω to 8 Ω allowance)

Tone Control Range:

Bass: ± 10 dB at 100 Hz

Treble: ± 10 dB at 10 kHz

Frequency Response: 40 Hz to 20 000 Hz

Signal-to-Noise Ratio: 70 dB

Line-Out Level/Impedance:

KS-FX43R/KS-FX483R/KS-FX480R:
2.0 V/20 k Ω load (250 nWb/m)

KS-F383R/KS-F380R:
1.0 V/20 k Ω load (250 nWb/m)

TUNER SECTION

Frequency Range:

FM: 87.5 MHz to 108.0 MHz

AM: (MW) 522 kHz to 1 620 kHz

(LW) 144 kHz to 279 kHz

[FM Tuner]

Usable Sensitivity: 11.3 dBf (1.0 μ V/75 Ω)

50 dB Quieting Sensitivity:

16.3 dBf (1.8 μ V/75 Ω)

Alternate Channel Selectivity (400 kHz):

65 dB

Frequency Response: 40 Hz to 15 000 Hz

Stereo Separation: 30 dB

Capture Ratio: 1.5 dB

[MW Tuner]

Sensitivity: 20 μ V

Selectivity: 35 dB

[LW Tuner]

Sensitivity: 50 μ V

CASSETTE DECK SECTION

Wow & Flutter: 0.15% (WRMS)

Fast-Wind Time: 190 sec. (C-60)

Frequency Response: 50 Hz to 14 000 Hz
(Normal tape)

Signal-to-Noise Ratio: 52 dB

Stereo Separation: 40 dB

GENERAL

Power Requirement:

Operating Voltage: DC 14.4 V

(11 V to 16 V allowance)

Grounding System: Negative ground

Allowable Operating Temperature: 0°C to +40°C

Dimensions (W \times H \times D):

Installation Size (approx.):

182 mm \times 52 mm \times 150 mm

Panel Size (approx.):

188 mm \times 58 mm \times 11 mm

Mass (approx.):

1.3 kg (excluding accessories)

Design and specifications are subject to change without notice.

Having TROUBLE with operation?

Please reset your unit

Refer to page of How to reset your unit

Haben Sie PROBLEME mit dem Betrieb?

Bitte setzen Sie Ihr Gerät zurück

Siehe Seite Zurücksetzen des Geräts

Vous avez des PROBLÈMES de fonctionnement?

Réinitialisez votre appareil

Référez-vous à la page intitulée Comment réinitialiser votre appareil

Hebt u PROBLEMEN met de bediening?

Stel het apparaat terug

Zie de pagina met de paragraaf Het apparaat terugstellen

JVC

VICTOR COMPANY OF JAPAN, LIMITED



EN, GE, FR, NL



1202KKSMJTJEIN

© 2002 VICTOR COMPANY OF JAPAN, LIMITED

Download from [Www.Somanuals.com](http://www.Somanuals.com). All Manuals Search And Download.

JVC

KS-FX43R/KS-FX483R/KS-FX480R

KS-F383R/KS-F380R

Installation/Connection Manual

Einbau/Anschlußanleitung

Manuel d'installation/raccordement

Handleiding voor installatie/aansluiting

GET0110-003A
[E/EX]

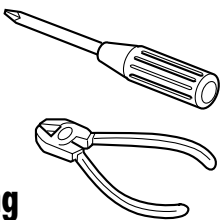

1202KKSMDTJEIN
EN, GE, FR, NL

ENGLISH

DEUTSCH

FRANÇAIS

NEDERLANDS

- This unit is designed to operate on 12 V DC, NEGATIVE ground electrical systems.

- Dieses Gerät ist für einen Betrieb in elektrischen Anlagen mit 12 V Gleichstrom und (-) Erdung ausgelegt.

- Cet appareil est conçu pour fonctionner sur des sources de courant continu de 12 V à masse NEGATIVE.

- Dit apparaat mag worden gebruikt bij elektrische systemen die werken op 12 V gelijkstroom met negatieve aarding.

INSTALLATION (IN-DASH MOUNTING)

EINBAU (IM ARMATURENBRETT)

INSTALLATION (MONTAGE DANS LE TABLEAU DE BORD)

INSTALLATIE (INBOUW IN HET DASHBOARD)

- The following illustration shows a typical installation. However, you should make adjustments corresponding to your specific car. If you have any questions or require information regarding installation kits, consult your JVC IN-CAR ENTERTAINMENT dealer or a company supplying kits.

- Die folgende Abbildung zeigt einen typischen Einbau. Dennoch müssen Sie entsprechend Ihrem jeweiligen Auto Anpassungen vornehmen. Bei irgendwelchen Fragen oder wenn Sie Informationen hinsichtlich des Einbausatzes brauchen, wenden Sie sich an ihren JVC Autoradiohändler oder ein Unternehmen das diese Einbausätze vertreibt.

- L'illustration suivante est un exemple d'installation typique. Cependant, vous devez faire les ajustements correspondant à votre voiture particulière. Si vous avez des questions ou avez besoin d'information sur des kits d'installation, consulter votre revendeur d'autoradios JVC ou une compagnie d'approvisionnement.

- Op de volgende afbeelding kunt u zien hoe de installatie, normaal gesproken, in zijn werk gaat. U moet echter bij de installatie rekening houden met de bijzonderheden van uw eigen auto. Neem bij vragen of voor meer bijzonderheden over inbouwpakketten contact op met uw JVC car audio dealer of een dealer of een bedrijf dat inbouwpakketten levert.

- 1 Before mounting:** Press (control panel release button) to detach the control panel if already attached.

* When shipped from the factory, the control panel is packed in the hard case.

- 2** Remove the trim plate.

- 3** Remove the sleeve after disengaging the sleeve locks.

① Stand the unit.

Note: When you stand the unit, be careful not to damage the fuse on the rear.

② Insert the 2 handles between the unit and the sleeve, as illustrated, to disengage the sleeve locks.

③ Remove the sleeve.

Note: Be sure to keep the handles for future use after installing the unit.

- 4** Install the sleeve into the dashboard.

* After the sleeve is correctly installed into the dashboard, bend the appropriate tabs to hold the sleeve firmly in place, as illustrated.

- 5** Fix the mounting bolt to the rear of the unit's body and place the rubber cushion over the end of the bolt.

- 6** Do the required electrical connections.

- 7** Slide the unit into the sleeve until it is locked.

- 8** Attach the trim plate.

- 9** Attach the control panel.

- 1 Vor dem Einbau:** Drücken Sie (Freigabe der Schalttafel), um die Arretierung der Schalttafel zu lösen, sofern diese bereits angebracht ist.

* Bei der Auslieferung ab Werk ist die Schalttafel im Etui verpackt.

- 2** Den Frontrahmen herausnehmen.

- 3** Die Halterung nach dem Entriegeln der Halterungssperren abnehmen.

① Das Gerät aufstellen.

Hinweis: Beim Aufstellen des Geräts darauf achten, daß die Sicherung auf der Rückseite nicht beschädigt wird.

② Die 2 Griffe zwischen dem Gerät und der Halterung wie abgebildet einstecken und die Halterungssperren entriegeln.

③ Die Halterung entfernen.

Hinweis: Sicherstellen, daß die Griffe für künftigen Gebrauch nach dem Einbau des Geräts aufbewahrt werden.

- 4** Die Halterung im Armaturenbrett einbauen.

* Nach dem korrekten Einbau der Halterung im Armaturenbrett, die entsprechenden Riegel umknicken, um die Halterung an ihrem Platz zu sichern, siehe Abbildung.

- 5** Die Befestigungsschraube an der Rückseite des Gerätekörpers befestigen und das Ende der Schraube mit einem Gummipuffer abdecken.

- 6** Nehmen Sie die erforderlichen elektrischen Anschlüsse vor.

- 7** Das Gerät in die Halterung schieben, bis es einrastet.

- 8** Befestigen Sie den Frontrahmen.

- 9** Die Schalttafel anbringen.

- 1 Avant le montage:** Appuyer sur (déblocage du panneau de commande) pour éventuellement détacher le panneau de commande.

* Lorsque ce panneau de commande sort d'usage, il est rangé dans un étui de transport.

- 2** Retirer la plaque d'assemblage.

- 3** Libérer les verrous du manchon et retirer le manchon.

① Poser l'appareil à la verticale.

Remarque: Lorsque vous mettez l'appareil à la verticale, faire attention de ne pas endommager le fusible situé sur l'arrière.

② Insérer les 2 poignées entre l'appareil et le manchon comme indiqué pour désengager les verrous de manchon.

③ Retirer le manchon.

Remarque: S'assurer de garder les poignées pour une utilisation ultérieure, après l'installation de l'appareil.

- 4** Installer le manchon dans le tableau de bord.

* Après installation correcte du manchon dans le tableau de bord, plier les bonnes pattes pour maintenir fermement le manchon en place, comme montré.

- 5** Monter le boulon de montage sur l'arrière du corps de l'appareil puis passer l'amortisseur en caoutchouc sur l'extrémité du boulon.

- 6** Réaliser les connexions électriques.

- 7** Faire glisser l'appareil dans le manchon jusqu'à ce qu'il soit verrouillé.

- 8** Attachez la plaque d'assemblage.

- 9** Remonter le panneau de commande.

- 1 Voordat u aan de montage van het apparaat begint:** Druk op (het bedieningspaneel vrijgeven) als u het bedieningspaneel wilt loskoppelen indien dit aan de eenheid is vastgekoppeld.

* Standaard wordt het bedieningspaneel bij het verlaten van de fabriek los verpakt meegeleverd.

- 2** Verwijder de sierplaat.

- 3** Verwijder het huis nadat u de klemmen hebt losgemaakt.

① Zet het apparaat rechtop.

Opmerking: Wanneer u het apparaat rechtop zet, moet u erop letten dat u de zekering aan de achterkant niet beschadigt.

② Plaats de 2 hendels, zoals afgebeeld, tussen het apparaat en het huis, om de klemmen los te maken.

③ Verwijder het huis.

Opmerking: Bewaar de hendels nadat u het apparaat hebt geïnstalleerd, zodat u ze ook in de toekomst kunt gebruiken.

- 4** Installeer het huis in het dashboard.

* Nadat het huis op de juiste wijze in het dashboard is geplaatst, moet u de palletjes, zoals afgebeeld, stevig op hun plaats duwen.

- 5** Maak de bevestigingsbout aan de achterkant van het apparaat vast en plaats de rubberdop over het uiteinde van de bout.

- 6** Breng de vereiste elektrische verbindingen tot stand.

- 7** Schuif het apparaat in het huis totdat het vergrendeld is.

- 8** Bevestig een sierplaat.

- 9** Bevestig het bedieningspaneel.

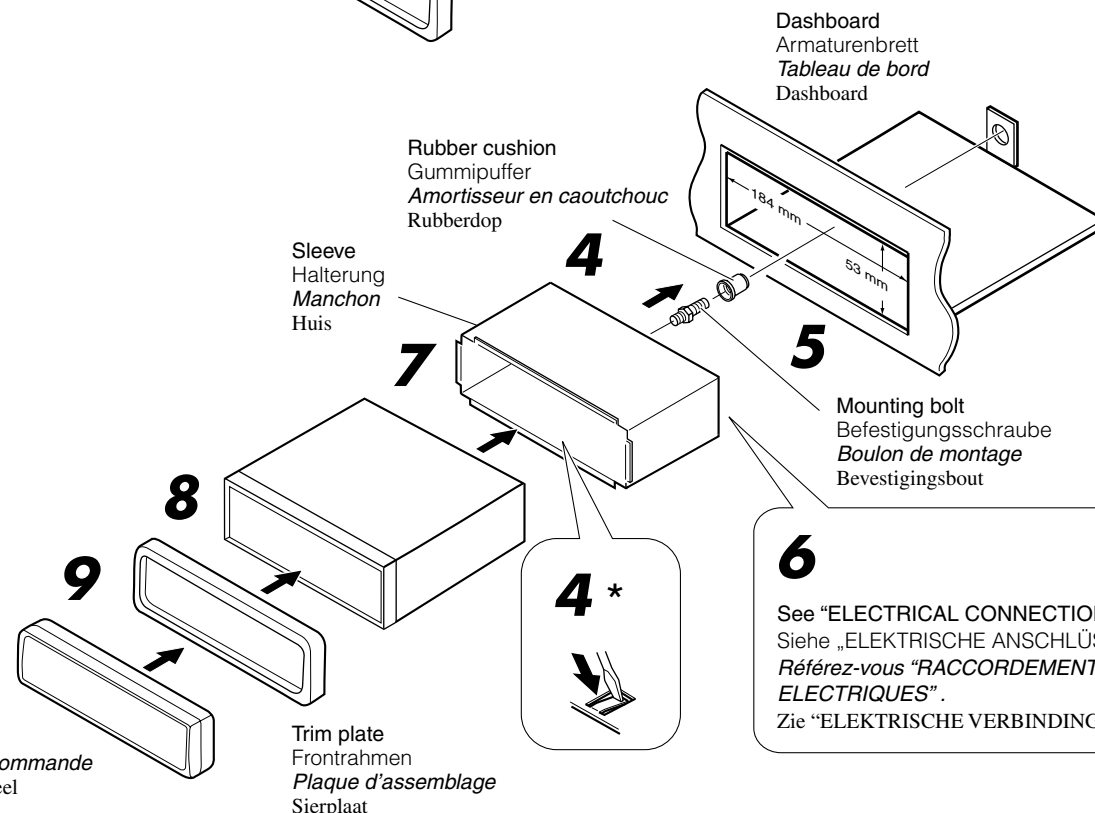
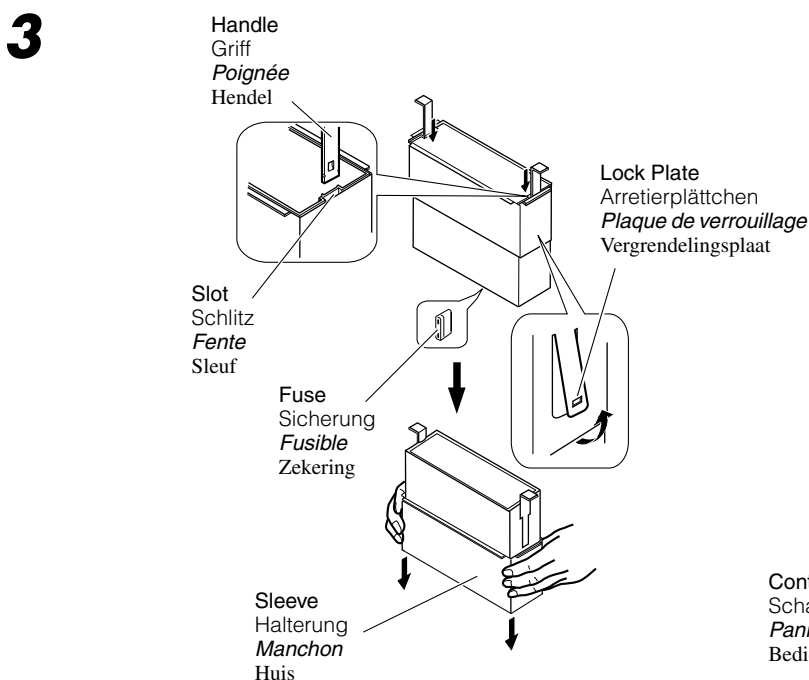
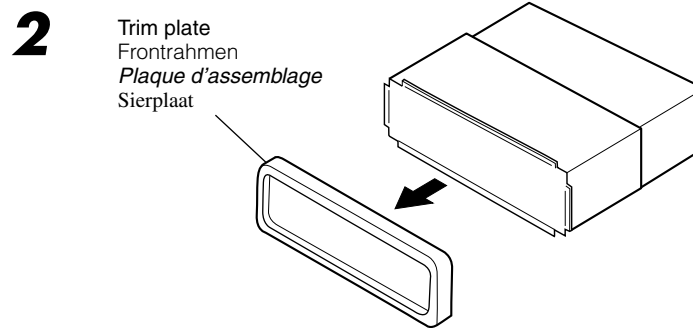
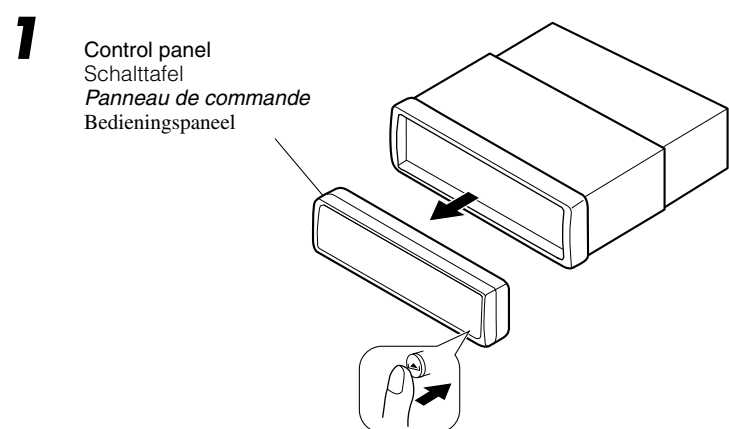

6 See "ELECTRICAL CONNECTIONS." Siehe „ELEKTRISCHE ANSCHLÜSSE“. Référez-vous "RACCORDEMENTS ELECTRIQUES". Zie "ELEKTRISCHE VERBINDINGEN".

- When using the optional stay
- Beim Verwenden der Anker-Option
- Lors de l'utilisation du hauban en option
- Wanneer u de steun gebruikt (facultatief)

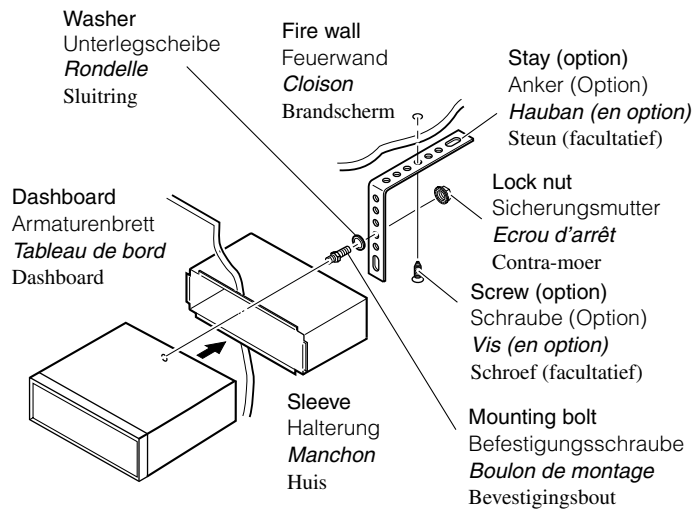

- When installing the unit without using the sleeve
- Beim Einbau des Geräts ohne Halterung
- Lors de l'installation de l'appareil sans utiliser de manchon
- Wanneer u het apparaat zonder huis installeert

In a Toyota for example, first remove the car radio and install the unit in its place. Zum Beispiel in einem Toyota zuerst das Autoradio ausbauen und dann das Gerät an seinem Platz einbauen. Par exemple dans une Toyota, retirer d'abord l'autoradio et installer l'appareil à la place. Voorbeeld: Bij een Toyota moet u eerst de autoradio verwijderen en daarna het apparaat installeren.

Flat type screws (M5 x 6 mm)*
Senkkopfschrauben (M5 x 6 mm)*
Vis à tête plate (M5 x 6 mm)*
Platkop Schroeven (M5 x 6 mm)*

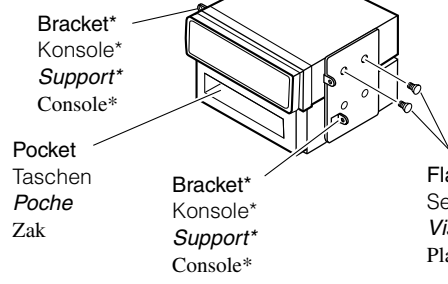

* Not included with this unit.
* Nicht Teil dieses Geräts.
* Non fourni avec cet appareil.
* Niet meegeleverd.

Note: When installing the unit on the mounting bracket, make sure to use the 6 mm-long screws. If longer screws are used, they could damage the unit.
Hinweis: Beim Anbringen des Geräts an der Konsole sicherstellen, daß 6 mm lange Schrauben verwendet werden. Werden längere Schrauben verwendet, können sie das Gerät beschädigen.
Remarque: Lors de l'installation de l'appareil sur le support de montage, s'assurer d'utiliser des vis d'une longueur de 6 mm. Si des vis plus longues sont utilisées, elles peuvent endommager l'appareil.
Opmerking: Wanneer u het apparaat aan de bevestigingsklem vastmaakt, moet u de 6 mm lange schroeven gebruiken. Als u langere schroeven gebruikt, kan het apparaat worden beschadigd.

Removing the unit

- Before removing the unit, release the rear section.

- 1 Remove the control panel.
- 2 Remove the trim plate.
- 3 Insert the 2 handles into the slots, as shown. Then, while gently pulling the handles away from each other, slide out the unit. **(Be sure to keep the handles after installing it.)**

Ausbau des Geräts

- Vor dem Ausbau des Geräts den hinteren Teil freigeben.

- 1 Den Schalttafel abnehmen.
- 2 Den Frontrahmen herausnehmen.
- 3 Die 2 Griffe in die Schlitze wie gezeigt stecken. Dann die Griffe behutsam auseinander ziehen und das Gerät herausziehen. **(Die Griffe nach dem Einbau auf jeden Fall aufbewahren.)**

Retrait de l'appareil

- Avant de retirer l'appareil, libérer la section arrière.

- 1 Retirer le panneau de commande.
- 2 Retirer la plaque d'assemblage.
- 3 Introduire les 2 poignées dans les fentes, comme montré. Puis, tout en tirant doucement les poignées écartées, faire glisser l'appareil pour le sortir. **(S'assurer de conserver les poignées après l'installation de l'appareil.)**

Verwijderen van het apparaat

- Voordat u het apparaat verwijdert, moet u het achtergedeelte losmaken.

- 1 Verwijder het bedieningspaneel.
- 2 Verwijder de sierplaat.
- 3 Plaats de 2 hendels, zoals afgebeeld, in de sleuven. Daarna duwt u de hendels zachtjes uit elkaar en kunt u het apparaat naar buiten schuiven. **(Bewaar de hendels nadat u het apparaat hebt geïnstalleerd!)**

1

Control panel
Schalttafel
Panneau de commande
Bedieningspaneel

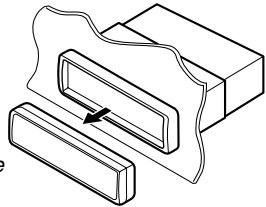

2

Trim plate
Frontrahmen
Plaque d'assemblage
Sierplaat

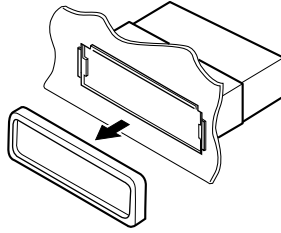

3

Handle
Griff
Poignée
Hendel

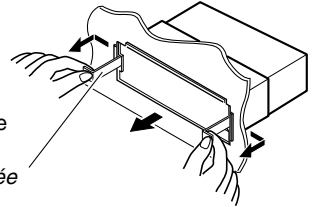

Parts list for installation and connection

The following parts are provided with this unit. After checking them, please set them correctly.

Teileliste für den Einbau und Anschluß

Die folgenden Teile werden zusammen mit diesem Gerät geliefert. Nach ihrer Überprüfung, die Teile richtig einsetzen.

Liste des pièces pour l'installation et raccordement

Les pièces suivantes sont fournies avec cet appareil. Après vérification, veuillez les placer correctement.

Lijst van onderdelen die u bij installatie en aansluiting nodig hebt

De volgende onderdelen worden bij het apparaat geleverd. Installeer ze op de juiste wijze, nadat u ze hebt gecontroleerd.

Hard case/Control panel
Etui/Schalttafel
Etui de transport/Panneau de commande
Behuizing/Bedieningspaneel

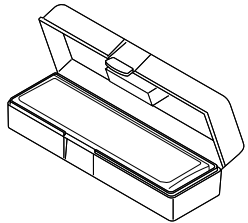

Sleeve
Halterung
Manchon
Huis

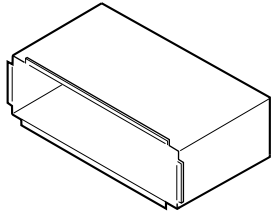

Trim plate
Frontrahmen
Plaque d'assemblage
Sierplaat

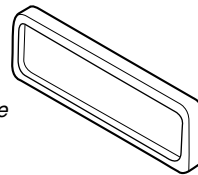

Power cord
Stromkabel
Cordon d'alimentation
Stroomkabel

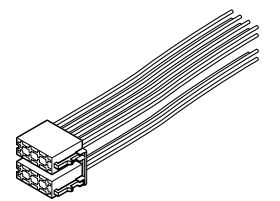

Handles
Griffe
Poignées
Hendels

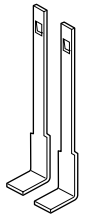

Washer (ø5)
Unterlegscheibe (ø5)
Rondelle (ø5)
Slutring (ø5)



Lock nut (M5)
Sicherungsmutter (M5)
Ecrou d'arrêt (M5)
Contra-moer (M5)



Mounting bolt (M5 x 20 mm)
Befestigungsschraube (M5 x 20 mm)
Boulon de montage (M5 x 20 mm)
Bevestigingsbout (M5 x 20 mm)



Rubber cushion
Gummipuffer
Amortisseur en caoutchouc
Rubberdop



ELECTRICAL CONNECTIONS

ELEKTRISCHE ANSCHLÜSSE

RACCORDEMENTS ELECTRIQUES

ELEKTRISCHE VERBINDINGEN

To prevent short circuits, we recommend that you disconnect the battery's negative terminal and make all electrical connections before installing the unit. If you are not sure how to install this unit correctly, have it installed by a qualified technician.

Zur Vermeidung von Kurzschlüssen empfehlen wir, daß Sie den negativen Batterieanschluß abtrennen und alle elektrischen Anschlüsse herstellen, bevor das Gerät eingebaut wird. Sind Sie sich über den richtigen Einbau des Geräts nicht sicher, lassen Sie es von einem qualifizierten Techniker einbauen.

Pour éviter tout court-circuit, nous vous recommandons de débrancher la borne négative de la batterie et d'effectuer tous les raccordements électriques avant d'installer l'appareil. Si l'on n'est pas sûr de pouvoir installer correctement cet appareil, le faire installer par un technicien qualifié.

Om kortsluiting te voorkomen adviseren wij u om de minpool van de accu los te maken en alle elektrische verbindingen tot stand te brengen voordat u het apparaat in de auto installeert. Als u niet zeker weet hoe u dit apparaat moet installeren, kunt u dit beter door een daartoe gekwalificeerde technicus laten doen.

Note:

This unit is designed to operate on **12 V DC, NEGATIVE ground electrical systems**. If your vehicle does not have this system, a voltage inverter is required, which can be purchased at JVC IN-CAR ENTERTAINMENT dealers.

- Replace the fuse with one of the specified rating. If the fuse blows frequently, consult your JVC IN-CAR ENTERTAINMENT dealer.
- If noise is a problem... This unit incorporates a noise filter in the power circuit. However, with some vehicles, clicking or other unwanted noise may occur. If this happens, connect the unit's **rear ground terminal** (see connection diagram) to the car's chassis using shorter and thicker cords, such as copper braiding or gauge wire. If noise still persists, consult your JVC IN-CAR ENTERTAINMENT dealer.
- Maximum input of the speakers should be more than 45 W at the rear and 45 W at the front, with an impedance of **4 Ω to 8 Ω**.
- **Be sure to ground this unit to the car's chassis.**
- The heat sink becomes very hot after use. Be careful not to touch it when removing this unit.

Hinweis: Dieses Gerät ist für einen Betrieb in **elektrischen Anlagen mit 12 V Gleichstrom und (-) Erdung ausgelegt**. Verfügt Ihr Fahrzeug nicht über diese Anlage, ist ein Spannungsinverter erforderlich, der bei JVC Autoradiohändler erworben werden kann.

- Die Sicherung mit einer der entsprechenden Nennleistung ersetzen. Brennt die Sicherung häufig durch, wenden Sie sich an Ihren JVC Autoradiohändler.
- Sind Störgeräusche ein Problem... Dieses Gerät enthält ein Störfilter im Stromkreis. Bei manchen Fahrzeugen kann jedoch ein Klicken oder andere unerwünschte Störgeräusche auftreten. Sollte das der Fall sein, die **hintere Erdungsanschlußklemme** (siehe Schaltplan) des Geräts am Fahrwerk des Fahrzeugs anschließen, dabei kürzere und dickere Kabel wie beispielsweise Kupfergeflechtdraht oder Stahldraht verwenden. Bleibt Störgeräusch bestehen, wenden Sie sich an Ihren JVC Autoradiohändler.
- Die maximale Eingangsleistung der Lautsprecher sollte mehr als 45 W hinten und 45 W vorn bei einer Impedanz von **4 Ω bis 8 Ω**.
- **Sicherstellen, daß das Gerät am Fahrwerk geerdet wird.**
- Das Abstrahlblech wird nach dem Gebrauch sehr heiß. Beim Ausbau des Geräts darauf achten, das Abstrahlblech nicht zu berühren.

Remarque: Cet appareil est conçu pour fonctionner sur des sources de courant continu de **12 V à masse NEGATIVE**. Si votre véhicule n'offre pas ce type d'alimentation, il vous faut un convertisseur de tension, que vous pouvez acheter chez un revendeur d'autoradios JVC.

- Remplacer le fusible par un de la valeur précisée. Si le fusible saute souvent, consulter votre revendeur d'autoradios JVC.
- Si le bruit est un problème... Cet appareil incorpore un filtre de bruit dans le circuit d'alimentation. Cependant, avec certains véhicules, quelques claquements ou autres bruits non désirés risquent de se produire. Si cela arrive, raccorder la borne arrière de masse de l'appareil au châssis de la voiture (voir le diagramme de raccordement) en utilisant des cordons les plus gros et les plus courts possibles telle qu'une barre de cuivre ou une tresse. Si le bruit persiste, consulter votre revendeur d'autoradios JVC.
- La puissance admissible des enceintes devrait supérieure à 45 W à l'arrière et à 45 W l'avant, avec une impédance de **4 Ω à 8 Ω**.
- **S'assurer de raccorder la mise à la masse de cet appareil au châssis de la voiture.**
- Le dissipateur de chaleur devient très chaud après usage. Faire attention de ne pas le toucher en retirant cet appareil.

Opmerking: Dit apparaat mag worden gebruikt bij elektrische systemen die werken op **12 V gelijkstroom met negatieve aarding**. Als uw auto niet is uitgerust met een dergelijk systeem, is een spanningsomzetter vereist. Dit instrument kan worden aangeschaft bij JVC car audio dealers.

- Vervang de zekering door een exemplaar met het aangegeven vermogen. Als de zekering vaak doorslaat, moet u uw JVC car audio dealer raadplegen.
- Als u geluidsproblemen hebt... De krachtschakeling van dit apparaat heeft een ingebouwd geluidsfilter. In sommige voertuigen zijn tikgeluiden of andere ongewenste geluiden te horen. Als dit gebeurt, moet u de **massaklem aan de achterkant** (zie aansluitingsschema) aan het chassis van de auto vastmaken met behulp van een kortere en dikkere kabel, zoals kopermanteldraad of tellerkabel. Als het geluid niet verdwijnt, moet u contact opnemen met uw JVC car audio dealer.
- Het maximum ingangsvermogen van de speakers moet achterin meer dan 45 W zijn en voorin 45 W, met een impedantie van **4 Ω tot 8 Ω**.
- **Zorg ervoor dat dit apparaat door middel van een aardkabel is verbonden met het chassis van de auto.**
- De warmte-opnemer kan na gebruik erg heet worden. Raak de warmte-opnemer niet aan wanneer u dit apparaat van zijn plaats haalt.

Heat sink
Abstrahlblech
Dissipateur de chaleur
Warmte-opnemer

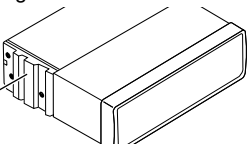

Typical Connections / Typische Anschlüsse / Raccordements typiques / Normale verbindingen

Before connecting: Check the wiring in the vehicle carefully. Incorrect connection may cause serious damage to this unit.

The leads of the power cord and those of the connector from the car body may be different in color.

1 Connect the colored leads of the power cord to the car battery, speakers and power aerial (if any) in the following sequence.

- ① Black: ground
- ② Yellow: to car battery (constant 12 V)
- ③ Red: to an accessory terminal
- ④ Blue with white stripe: to remote lead of other equipment or power aerial if any (200 mA max.)
- ⑤ Brown: to cellular phone system (For details, refer to the instructions of the cellular phone.)
- ⑥ Others: to speakers

2 Connect the aerial cord.

3 Finally connect the wiring harness to the unit.

Note: If your vehicle does not have any accessory terminal, move the fuse from the fuse position 1 (initial position) to fuse position 2, and connect the red lead (A7) to the positive (+) battery terminal.

• The yellow lead (A4) is not used in this case.

Vor dem Anschließen: Die Verdrahtung im Fahrzeug sorgfältig überprüfen. Falsche Anschlüsse können ernsthafte Schäden am Gerät hervorrufen.

Die Leiter des Stromkabels und die Leiter des Anschlusses im Fahrzeug können sich farblich unterscheiden.

1 Die farbigen Leitungen des Spannungsversorgungskabels an der Autobatterie, antestekungsschakelaarden Lautsprechern und dem Motorantenne (sofern vorhanden) in folgender Reihenfolge anschließen.

- ① Schwarz: Erdung
- ② Gelb: an Autobatterie (konstant 12 V)
- ③ Rot: zur einer Zubehörananschlußklemme
- ④ Blau mit weißem Streifen: zum Zusatzkabel des anderen Geräts oder der Motorantenne, sofern vorhanden (max. 200 mA)
- ⑤ Braun: an Mobiltelefon (Weitere Informationen entnehmen Sie bitte der Bedienungsanleitung des Mobiltelefons.)
- ⑥ Andere: zur Lautsprecher

2 Das Antennenkabel anschließen.

3 Die Kabelbäume am Gerät anschließen.

Hinweis: Verfügt Ihr Fahrzeug nicht über eine Zubehörananschlußklemme, die Sicherung von der 1. Sicherungsposition (Erstposition) in die 2. Sicherungsposition versetzen, die rote Leitung (A7) an der (+) Batterieanschlußklemme anschließen.

• Die gelbe Leitung (A4) wird in diesem Fall nicht verwendet.

Avant de commencer la connexion: Vérifiez attentivement le câblage du véhicule. Une connexion incorrecte peut endommager sérieusement l'appareil. Le fil du cordon d'alimentation et ceux des connecteurs du châssis de la voiture peuvent être différents en couleur.

1 Connectez les fils de couleur du cordon d'alimentation à la batterie de la voiture, aux enceintes et à l'antenne automatique (s'il y en a une) dans l'ordre suivant.

- ① Noir: à la masse
- ② Jaune: à la batterie de la voiture (12 V constant)
- ③ Rouge: à une borne accessoire
- ④ Bleu avec bande blanche: au fil de télécommande de l'autre appareil ou à l'antenne automatique s'il y en a une (200 mA max.)
- ⑤ Marron: à un système de téléphone cellulaire (Pour les détails, se référer aux instructions du téléphone cellulaire.)
- ⑥ Autres: aux enceintes

2 Connectez le cordon d'antenne.

3 Finalement, connectez le faisceau de fils à l'appareil.

Remarque: Si votre véhicule ne possède pas de borne accessoire, déplacez le fusible de la position de fusible 1 (position originale) à la position de fusible 2 et connectez le fil rouge (A7) à la borne positive (+) de la batterie.

• Le fil jaune (A4) n'est pas utilisé dans ce cas.

Alvorens de verbindingen tot stand te brengen: Moet u de bedrading in de auto zorgvuldig. Het apparaat kan door verkeerde verbindingen ernstige schade oplopen. De draden van het stroomkabel verschillen mogelijk in kleur met de aansluitingen op het chassis van de auto.

1 Sluit de gekleurde snoerdraden van de stroomkabel in de hierna genoemde volgorde aan op de accu van de auto, de luidsprekers en de antenne (indien aanwezig).

- ① Zwart: aarde
- ② Geel: naar de accu van de auto (constant 12 V)
- ③ Rood: naar de aansluitklem van de accessoire
- ④ Blauw met witte streep: naar afstandsdraad van andere apparatuur of antenne met circuit indien aanwezig (200 mA max.)
- ⑤ Bruin: Naar het mobiele-telefoonsysteem (Lees voor meer informatie de instructies die bij de mobiele telefoon worden geleverd.)
- ⑥ Andere: naar de speakers

2 Sluit de antenne aan.

3 Verbind de draadbundel daarna met het apparaat.

Opmerking: Als uw voertuig niet beschikt over een aansluitklem, moet u de zekering verplaatsen van stand 1 (beginstand) naar stand 2 en moet u de rode draad (A7) met de pluspool (+) van de accu verbinden.

• In dit geval wordt de gele draad (A4) niet gebruikt.

To steering wheel remote controller

—Only for KS-FX43R (see diagram)

An Lenkradfernbedienung

—Nur für KS-FX43R (siehe Schaltplan)

Pour la télécommande de volant

—Seulement pour le KS-FX43R

(voir le diagramme)

Naar stuurwiel-afstandsbediening

—Alleen voor de KS-FX43R (zie schema)

Rear ground terminal

Hintere Erdungsschlußklemme

Borne arrière de masse

Massaklem aan de achterkant

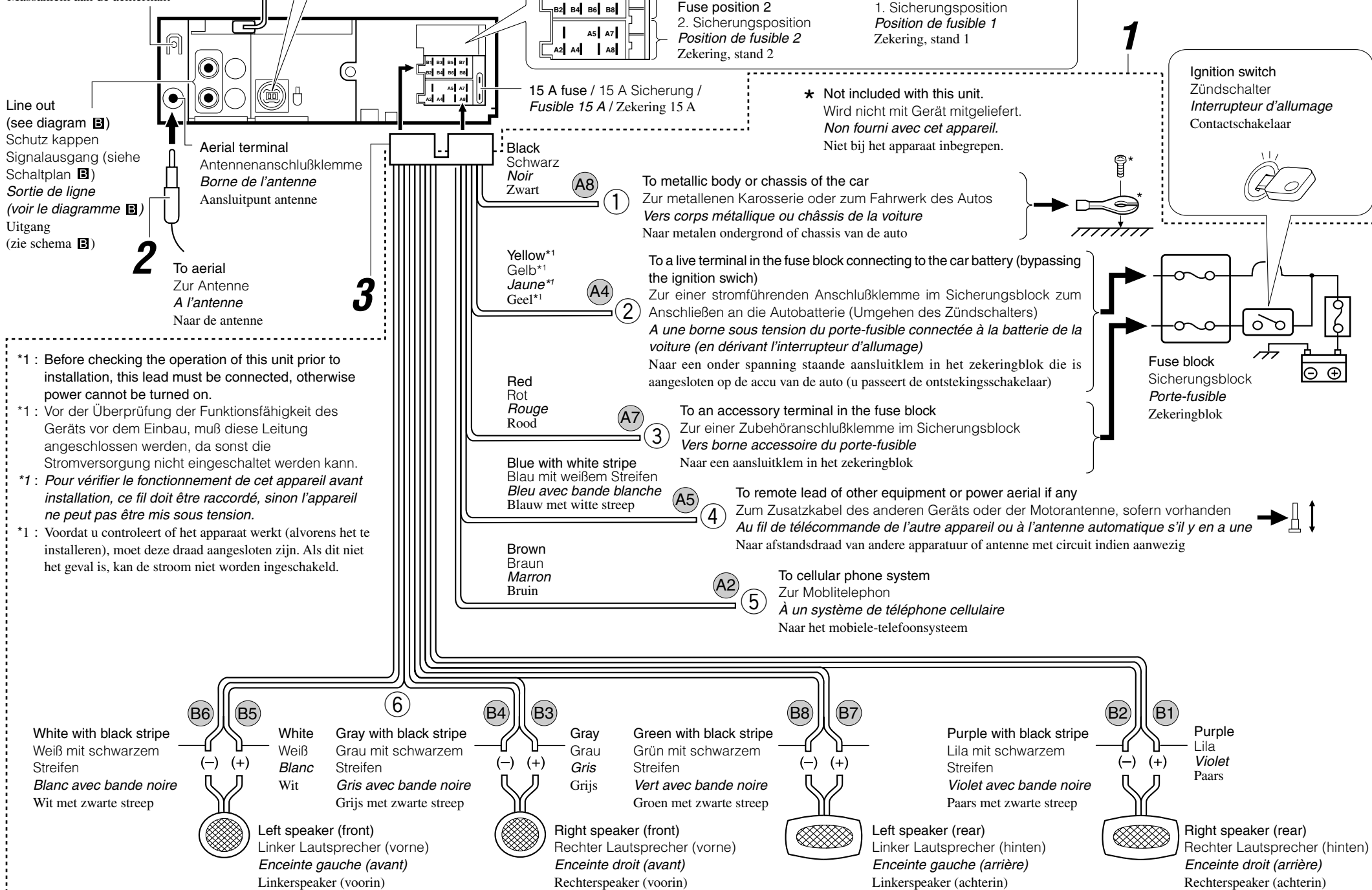

TROUBLESHOOTING

- **The fuse blows.**
* Are the red and black leads connected correctly?
- **Power cannot be turned on.**
* Is the yellow lead connected?
- **No sound from the speakers.**
* Is the speaker output lead short-circuited?
- **Sound is distorted.**
* Is the speaker output lead grounded?
* Are the “-” terminals of L and R speakers grounded in common?
- **Unit becomes hot.**
* Is the speaker output lead grounded?
* Are the “-” terminals of L and R speakers grounded in common?

FEHLERSUCHE

- **Die Sicherung brennt durch.**
* Sind die roten und schwarzen Leitungen richtig angeschlossen?
- **Stromversorgung kann nicht eingeschaltet werden.**
* Ist die gelbe Leitung angeschlossen?
- **Kein Ton aus den Lautsprechern.**
* Ist die LautsprecherAusgangsleitung kurzgeschlossen?
- **Ton verzerrt.**
* Ist die LautsprecherAusgangsleitung geerdet?
* Sind die (-) Anschlußklemmen der linken und rechten Lautsprecher zusammen geerdet?
- **Gerät wird heiß.**
* Ist die LautsprecherAusgangsleitung geerdet?
* Sind die (-) Anschlußklemmen der linken und rechten Lautsprecher zusammen geerdet?

EN CAS DE DIFFICULTES

- **Le fusible saute.**
* Les fils rouge et noir sont-ils raccordés correctement?
- **L'appareil ne peut pas être mise sous tension.**
* Le fil jaune est-elle raccordée?
- **Pas de son des enceintes.**
* Le fil de sortie d'enceinte est-il court-circuité?
- **Le son est déformé.**
* Le fil de sortie d'enceinte est-il à la masse?
* Les bornes “-” des enceintes gauche et droit sont-elles mises ensemble à la masse?
- **L'appareil devient chaud.**
* Le fil de sortie d'enceinte est-il à la masse?
* Les bornes “-” des enceintes gauche et droit sont-elles mises ensemble à la masse?

PROBLEMEN OPLOSSEN

- **De zekering slaat door.**
* Zijn de rode en de zwarte draden op de juiste manier aangesloten?
- **De stroom kan niet worden ingeschakeld.**
* Is de gele draad aangesloten?
- **Er komt geen geluid uit de speakers.**
* Is de uitgaande speakerdraad kortgesloten?
- **Het geluid wordt vervormd.**
* Is de uitgaande speakerdraad geerd?
- **Het apparaat raakt verhit.**
* Is de uitgaande speakerdraad geerd?
* Zijn de “-” polen van de linker- en de rechterspeakers gemeenschappelijk geerd?

PRECAUTIONS on power supply and speaker connections:

- DO NOT connect the speaker leads of the power cord to the car battery; otherwise, the unit will be seriously damaged.
- Connect the black lead (ground), yellow lead (to car battery, constant 12 V), and red lead (to an accessory terminal) correctly.
- BEFORE connecting the speaker leads of the power cord to the speakers, check the speaker wiring in your car.
 - If the speaker wiring in your car is as illustrated in Fig. 1 and Fig. 2 below, DO NOT connect the unit using that original speaker wiring. If you do, the unit will be seriously damaged. Redo the speaker wiring so that you can connect the unit to the speakers as illustrated in Fig. 3.
 - If the speaker wiring in your car is as illustrated in Fig. 3, you can connect the unit using the original speaker wiring in your car.
 - If you are not sure of the speaker wiring of your car, consult your car dealer.

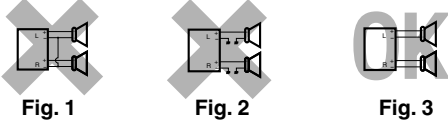

VORSICHTSMASSEGELN beim Anschließen der Stromversorgung und Lautsprecher:

- Die Lautsprecherleitungen des Netzkabels NICHT an der Autobatterie anschließen, da sonst das Gerät schwer beschädigt wird.
- Die schwarze Leitung (Erdung), die gelbe Leitung (zur Autobatterie, konstant 12 V) und die rote Leitung (zur Zubehöranschlusssklemme) richtig anschließen.
- VOR dem Anschließen der Lautsprecherleitungen des Spannungsversorgungskabels an die Lautsprecher, die Lautsprecherverdrahtung in Ihrem Auto überprüfen.
 - Ist die Lautsprecherverdrahtung wie unten in „Fig. 1“ und „Fig. 2“ abgebildet, das Gerät NICHT mit der Originalverdrahtung der Lautsprecher anschließen, da sonst das Gerät schwer beschädigt wird. Die Lautsprecherverdrahtung erneuern, so daß Sie das Gerät an den Lautsprechern wie in „Fig. 3“ abgebildet anschließen können.
 - Ist die Lautsprecherverdrahtung in Ihrem Auto wie in „Fig. 3“ abgebildet, können Sie das Gerät mit der Originalverdrahtung der Lautsprecher in Ihrem Auto anschließen.
 - Sind Sie sich über die Lautsprecherverdrahtung in Ihrem Auto nicht sicher, wenden Sie sich an Ihren Autohändler.

PRECAUTIONS sur l'alimentation et la connexion des enceintes:

- NE CONNECTEZ PAS les fils d'enceintes du cordon d'alimentation à la batterie; sinon, l'appareil serait sérieusement endommagé.
- Connectez correctement le fil noir (à la masse), le fil jaune (à la batterie de la voiture, 12 V constant) et le fil rouge (à la prise accessoire).
- AVANT de connecter les fils d'enceintes du cordon d'alimentation aux enceintes, vérifiez le câblage des enceintes de votre voiture.
 - Si le câblage des enceintes de votre voiture est comme montré sur la Fig. 1 ou Fig. 2 ci-dessous, NE CONNECTEZ PAS l'appareil en utilisant ce câblage original des enceintes. Si vous le faites, l'appareil sera sérieusement endommagé. Recommencez le câblage des enceintes de façon que vous puissiez connecter l'appareil aux enceintes comme montré sur la Fig. 3.
 - Si le câblage des enceintes de votre voiture est comme montré sur la Fig. 3, vous pouvez connecter l'appareil en utilisant ce câblage original d'enceintes pour votre voiture.
 - Si vous n'êtes pas sûrs du câblage d'enceintes de votre voiture, consulter le concessionnaire de votre voiture.

VOORZORGSMAATREGELEN bij het verbinden van de stroomkabeldraad met de speakers:

- Verbind de speakerdraden van de stroomkabel NIET met de accu van de auto; als u dit wel doet, zal het apparaat ernstige schade oplopen.
- Sluit de zwarte draad (aarde), de gele draad (naar de accu van de auto, constant 12 V) en de rode draad (naar de aansluitklem van de accessoire) op de juiste wijze aan.
- VOORDAT u de speakerdraden van de stroomkabel met de speakers verbindt, moet u de bedrading van de speakers in uw auto controleren.
 - Als de bedrading van de speakers eruitziet zoals hieronder staat afgebeeld in Fig. 1 en Fig. 2, mag het apparaat NIET worden aangesloten met behulp van deze oorspronkelijke speakerbedrading. Als u dat wel doet, zal het apparaat ernstige schade oplopen. Pas de bedrading van de speakers aan, zodat u het apparaat met de speakers kunt verbinden, zoals staat afgebeeld in Fig. 3.
 - Als de bedrading van de speakers eruitziet zoals staat afgebeeld in Fig. 3, kunt u het apparaat aansluiten met behulp van de oorspronkelijke speakerbedrading in uw auto.
 - Als u twijfels hebt over de speakerbedrading in uw auto, moet u contact opnemen met uw autodealer.

Connecting the leads / Anschließen der Leitungen / Raccordement des fils / Aansluiting van de gekleurde draden

Twist the core wires when connecting.
Die Kerndrähte beim Anschließen verdrehen.
Torsader les âmes des fils en les raccordant.
Draai de kerndraden om elkaar heen wanneer u ze wilt aansluiten.

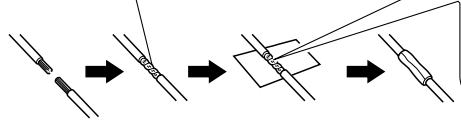

Solder the core wires to connect them securely.
Die Kerndrähte anlöten, um sie fest anzuschließen.
Souder les âmes des fils pour les raccorder entre eux de façon sûre.
Soldeer de kerndraden zodat ze stevig vast zitten.



CAUTION / VORSICHT / PRECAUTION / LET OP!:

- To prevent short-circuit, cover the terminals of the UNUSED leads with insulating tape.
- Zur Vermeidung eines Kurzschlusses die Anschlußklemmen der NICHT VERWENDETEN Leitungen mit Isolierklebeband umwickeln.
- Pour éviter les court-circuits, couvrir les bornes des fils qui ne sont PAS UTILISÉS avec de la bande isolante.
- Om kortsluiting te voorkomen, moet u de aansluitklemmen van ONGEBRUIKTE gekleurde draden met isolatieband bedekken.

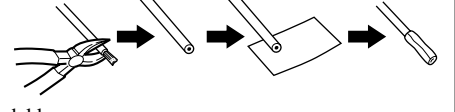

Connections Adding Other Equipment / Anschlüsse zum Hinzufügen von anderer Ausrüstung / Raccordement pour ajouter d'autres appareils / Aansluitingen voor het toevoegen van andere apparatuur

You can connect an amplifier and other equipment to upgrade your car stereo system.

- Connect the remote lead (blue with white stripe) to the remote lead of the other equipment so that it can be controlled through this unit.
- For amplifier only:
 - Connect this unit's line-out terminals to the amplifier's line-in terminals.
 - Disconnect the speakers from this unit, connect them to the amplifier. Leave the speaker leads of this unit unused. (Cover the terminals of these unused leads with insulating tape, as illustrated above.)

Sie können einen Verstärker oder ein anderes Gerät anschließen, um Ihre Autostereoanlage zu erweitern.

- Schließen Sie das Fernbedienungskabel (blau mit weißem Streifen) an das Fernbedienungskabel des anderen Geräts an, so daß es über dieses Gerät gesteuert werden kann.
- Nur für den Verstärker:
 - Die Anschlußklemmen am Ausgang dieses Gerät an den Anschlußklemmen des Eingangs des Verstärkers anschließen.
 - Die Lautsprecher von diesem Gerät abtrennen und am Verstärker anschließen. Die Lautsprecherleitungen dieses Geräts unbenutzt lassen. (Die Anschlußklemmen dieser nicht verwendeten Leitungen mit Isolierklebeband umwickeln, siehe Abbildung oben.)

Vous pouvez connecter un amplificateur ou autre appareil pour améliorer votre système autoradio.

- Connectez le fil de commande à distance (bleu avec bande blanche) au fil de commande à distance de l'autre appareil de façon qu'il puisse être commandé via cet appareil.
- Pour l'amplificateur seulement:
 - Raccorder les bornes de sortie ligne de cet appareil aux bornes d'entrée ligne de l'amplificateur.
 - Déconnectez les enceintes de cet appareil et connectez-les à l'amplificateur. Laissez les fils d'enceintes de cet appareil inutilisés. (Recouvrir les extrémités de ces fils inutilisés avec de la bande isolante comme montré ci-dessus.)

Het is mogelijk om uw autostereosysteem uit te breiden met een versterker of andere apparatuur.

- Verbind de externe kabel (blauw met witte streep) met de externe kabel van het andere apparaat zodat deze op afstand vanaf deze apparaat kan worden bediend.
- Alleen voor een versterker:
 - Verbind de uitgang van het apparaat met de ingang van de versterker.
 - Koppel de speakers van dit apparaat los en verbind ze aan de versterker. Gebruik de speakerdraden van dit apparaat niet. (Plak de aansluitklemmen van deze speakerdraden met isolatieband af zoals hierboven is afgebeeld.)

Amplifier / Verstärker / Amplificateur / Versterker

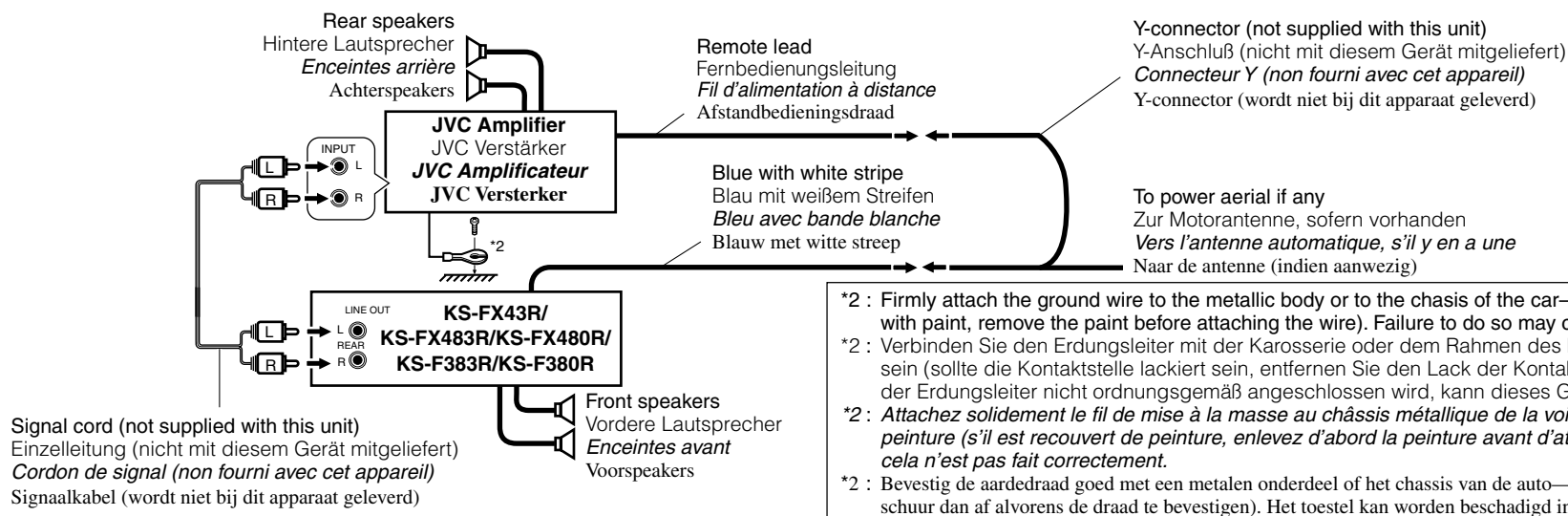

CD changer / CD-Wechsler / Changeur CD / CD-wisselaar

Only for KS-FX43R/KS-FX483R/KS-FX480R:

You can connect a JVC CD changer.

- For the connections, refer to the Instructions supplied with them.

Nur für KS-FX43R/KS-FX483R/KS-FX480R:

Sie können einen CD-Wechsler von JVC.

- Weitere Informationen über den Anschluß können Sie der Bedienungsanleitung entnehmen, die dem jeweiligen Gerät beiliegt.

Seulement pour le KS-FX43R/KS-FX483R/KS-FX480R:

Vous pouvez connecter un changeur CD JVC.

- Pour les connexions, référez-vous aux modes d'emploi qui les accompagnent.

Alleen voor KS-FX43R/KS-FX483R/KS-FX480R:

Het is mogelijk een JVC CD-wisselaar aan te sluiten.

- Zie de instructies van deze apparaten voor meer informatie over het tot stand brengen van deze aansluiting.

Connecting cord supplied with your CD changer
Verbindingskabel, dat zum Lieferumfang des CD-Wechsler gehört
Cordon de connexion fourni avec votre changeur CD
Verbindingskabel die met de CD-wisselaar wordt meegeleverd
KS-FX43R/KS-FX483R/KS-FX480R

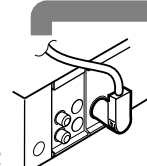

JVC CD changer
CD-Wechsler von JVC
Changeur CD JVC
JVC CD-wisselaar

CAUTION / VORSICHT / PRECAUTION / LET OP!:

- Before connecting the CD changer, make sure that the unit is turned off.
- Bevor Sie den CD-Wechsler anschließen, vergewissern Sie sich, daß das Gerät ausgeschaltet ist.
- Avant de connecter le changeur CD, s'assurer que l'unité est éteinte.
- Zorg ervoor dat de apparat is uitgeschakeld alvorens u de CD-wisselaar aansluit.

Connecting to the steering wheel remote controller / Anschluß an die Lenkradfernbedienung / Connexion de la télécommande de volantcontroller / Verbinden met de stuurwiel-afstandsbediening

Only for KS-FX43R / Nur für KS-FX43R / Seulement pour le KS-FX43R / Alleen voor KS-FX43R

If your car is equipped with the steering wheel remote controller, you can operate this receiver using the controller. To do it, a JVC's OE remote adapter (not supplied) which matches with your car is required. Consult your JVC IN-CAR ENTERTAINMENT dealer for details.

Wenn Ihr Fahrzeug mit einer Lenkradfernbedienung ausgestattet ist, können Sie damit diesen Receiver steuern. Hierfür ist ein für Ihr Fahrzeug passender OE-Fernbedienungsadapter von JVC (nicht im Lieferumfang enthalten) erforderlich. Für weitere Einzelheiten wenden Sie sich an Ihren JVC Autoradiohändler.

Si votre voiture est munie d'une télécommande de volant, vous pouvez commander cet autoradio en utilisant la télécommande. Pour le faire, un adaptateur de télécommande de volant (non fourni) correspondant à votre voiture est nécessaire. Consultez votre revendeur d'autoradio JVC pour les détails.

Indien uw auto een stuurwiel-afstandsbediening (niet bijgeleverd) heeft, kunt u deze receiver met die afstandsbediening bedienen. Hiervoor heeft u echter een JVC adapter nodig die geschikt is voor de stuurwiel-afstandsbediening in uw auto. Raadpleeg uw JVC car audio dealer voor details.

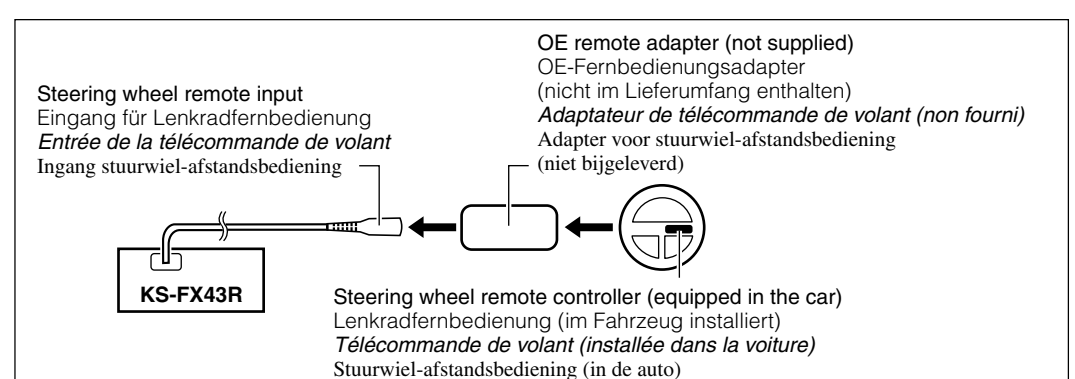

Free Manuals Download Website

<http://myh66.com>

<http://usermanuals.us>

<http://www.somanuals.com>

<http://www.4manuals.cc>

<http://www.manual-lib.com>

<http://www.404manual.com>

<http://www.luxmanual.com>

<http://aubethermostatmanual.com>

Golf course search by state

<http://golfingnear.com>

Email search by domain

<http://emailbydomain.com>

Auto manuals search

<http://auto.somanuals.com>

TV manuals search

<http://tv.somanuals.com>