

JVC

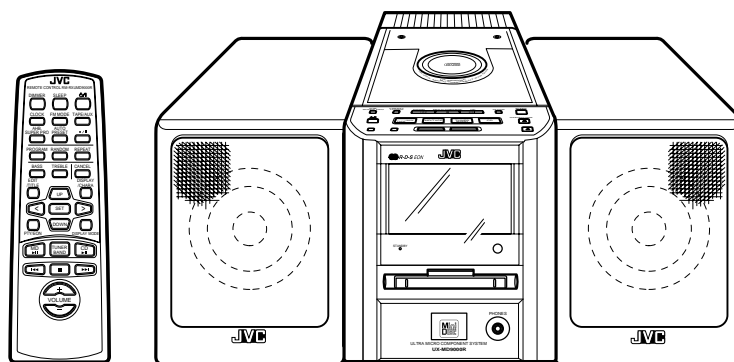

ULTRA MICRO COMPONENT SYSTEM
ULTRA-MIKRO-KOMPONENTEN-SYSTEM
SYSTEME DE COMPOSANTS ULTRA MICRO
ULTRA MIKRO KOMPONENTENSISTEEM
SISTEMAS DE COMPONENTES ULTRA MICRO
SISTEMA AD ULTRA MICROCOMPONENTI

UX-MD9000R



R-D-S EON

COMPACT
disc
DIGITAL AUDIO

INSTRUCTIONS
BEDIENUNGSANLEITUNG
MANUEL D'INSTRUCTIONS
GEBRUIKSAANWIJZING
MANUAL DE INSTRUCCIONES
ISTRUZIONI

For Customer Use:

Enter below the Model No. and Serial No.
which are located either on the rear, bot-
tom or side of the cabinet. Retain this
information for future reference.

Model No. _____

Serial No. _____

LVT0053-001B

[E]

Warnings, Cautions and Others / Warnung, Achtung und sonstige Hinweise / Mises en garde, précautions et indications diverses / Waarschuwingen, voorzorgen en andere mededelingen / Avisos, precauciones y otras notas / Avvertenze e precauzioni da osservare

Caution — ϕ /I switch!

Disconnect the mains plug to shut the power off completely. The ϕ /I switch in any position does not disconnect the mains line. The power can be remote controlled.

Achtung — ϕ /I Schalter!

Den Netzstecker aus der Steckdose ziehen, um die Stromversorgung vollkommen zu unterbrechen. Der Schalter ϕ /I unterbricht in keiner Stellung die Stromversorgung vollkommen. Die Stromversorgung kann mit der Fernbedienung ein- und ausgeschaltet werden.

Attention — Commutateur ϕ /I!

Déconnecter la fiche de secteur pour couper complètement le courant. Le commutateur ϕ /I ne coupe jamais complètement la ligne de secteur, quelle que soit sa position. Le courant peut être télécommandé.

Voorzichtig — ϕ /I schakelaar!

Om de stroomtoevoer geheel uit te schakelen, trekt u de stekker uit het stopcontact. Anders zal er altijd een geringe hoeveelheid stroom naar het apparaat lopen, ongeacht de stand van de ϕ /I schakelaar. U kunt het apparaat ook met de afstandsbediening aan- en uitschakelen.

Precaución — Interruptor ϕ /I!

Desconectar el cable de alimentación para desactivar la alimentación totalmente. Cualquier que sea la posición de ajuste del interruptor ϕ /I, la alimentación no es cortada completamente. La alimentación puede ser controlada remotamente.

Attenzione — L'interruttore ϕ /I !

Disinserire la spina del cavo di alimentazione dalla presa della rete elettrica per staccare completamente l'alimentazione. L'interruttore ϕ /I in nessuna posizione stacca la linea di alimentazione elettrica principale. È possibile il controllo remoto dell'alimentazione.

Per l'Italia:

"Si dichiara che il questo prodotto di marca JVC è conforme alle prescrizioni del Decreto Ministeriale n.548 del 28/08/95 pubblicato sulla Gazzetta Ufficiale della Repubblica Italiana n.301 del 28/12/95."

CAUTION

To reduce the risk of electrical shocks, fire, etc.:

1. Do not remove screws, covers or cabinet.
2. Do not expose this appliance to rain or moisture.

ACHTUNG

Zur Verhinderung von elektrischen Schlägen, Brandgefahr, usw:

1. Keine Schrauben lösen oder Abdeckungen entfernen und das Gehäuse nicht öffnen.
2. Dieses Gerät weder Regen noch Feuchtigkeit aussetzen.

ATTENTION

Afin d'éviter tout risque d'électrocution, d'incendie, etc.:

1. Ne pas enlever les vis ni les panneaux et ne pas ouvrir le coffret de l'appareil.
2. Ne pas exposer l'appareil à la pluie ni à l'humidité.

VOORZICHTIG

Ter vermindering van gevaar voor brand, elektrische schokken, enz.:

1. Verwijder geen schroeven, panelen of de behuizing.
2. Stel het toestel niet bloot aan regen of vocht.

PRECAUCIÓN

Para reducir riesgos de choques eléctricos, incendio, etc.:

1. No extraiga los tornillos, los cubiertas ni la caja.
2. No exponga este aparato a la lluvia o a la humedad.

ATTENZIONE

Per ridurre il rischio di shock elettrici, incendi, ecc.:

1. Non togliete viti, coperchi o la scatola.
2. Non esponete l'apparecchio alla pioggia e all'umidità.

Caution: Proper Ventilation

To avoid risk of electric shock and fire, and to prevent damage, locate the apparatus as follows:

- 1 Front:
 - No obstructions and open spacing.
- 2 Sides/ Top/ Back:
 - No obstructions should be placed in the areas shown by the dimensions below.
- 3 Bottom:
 - Place on the level surface. Maintain an adequate air path for ventilation by placing on a stand with a height of 10 cm or more.

Vorsicht: Ausreichende Belüftung

Zur Vermeidung von elektrischen Schlägen, Feuer und sonstigen Schäden sollte das Gerät unter folgenden Bedingungen aufgestellt werden:

- 1 Vorderseite:
 - Hindernisfrei und gut zugänglich.
- 2 Seiten- und Rückwände:
 - Hindernisfrei in allen gegebenen Abständen (s. Abbildung).
- 3 Unterseite:
 - Die Stellfläche muß absolut eben sein. Sorgen Sie für ausreichende Luftzufuhr durch Aufstellung auf einem Stand mit mindestens 10 cm Höhe.

Attention: Aération correcte

Pour prévenir tout risque de décharge électrique ou d'incendie et éviter toute détérioration, installez l'appareil de la manière suivante:

- 1 Avant:
 - Bien dégagé de tout objet.
- 2 Côtés/dessus/dessous:
 - Assurez-vous que rien ne bloque les espaces indiqués sur le schéma ci-dessous.
- 3 Dessous:
 - Posez l'appareil sur une surface plane et horizontale. Veillez à ce que sa ventilation correcte puisse se faire en le plaçant sur un support d'au moins dix centimètres de hauteur.

Voorzichtig: Goede ventilatie vereist

Om brand, elektrische schokken en beschadiging te voorkomen, moet u het toestel als volgt opstellen:

- 1 Voorkant:
 - Geen belemmeringen en voldoende ruimte.
- 2 Zijkanten/boven-/onderkant:
 - Geen belemmeringen plaatsen in de hieronder aangegeven zones.
- 3 Onderkant:
 - Op vlakke ondergrond plaatsen. Voldoende ventilatieruimte voorzien door het toestel op een onderstel met een hoogte van 10 cm of meer te plaatsen.

Precaucion: ventilación correcta

Para evitar el riesgo de descargas eléctricas e incendio y prevenir posibles daños, instale el equipo en un lugar que cumpla los siguientes requisitos:

- 1 Parte frontal:
 - Sin obstrucciones, espacio abierto.
- 2 Lados/parte superior/parte posterior:
 - No debe haber ninguna obstrucción en las áreas mostradas por las dimensiones de la siguiente figura.
- 3 Parte inferior:
 - Sitúe el equipo sobre una superficie nivelada. Mantenga un espacio adecuado para permitir el paso del aire y una correcta ventilación, situando el equipo sobre un soporte de 10 o más cm de altura.

Attenzione: Per una corretta ventilazione

Per prevenire il rischio di scosse elettriche e di incendio ed evitare possibili danni, collocare le apparecchiature nel modo seguente:

- 1 Parte anteriore:
 - Nessun ostacolo e spazio libero.
- 2 Lati/Parte superiore/Retro:
 - Lasciare libere le zone indicate dalle dimensioni di seguito.
- 3 Base:
 - Collocare su una superficie piana. Consentire un'adeguata ventilazione dell'impianto appoggiandolo su un tavolino alto almeno 10 cm.

Front view
Vorderansicht
Face
Vooraanzicht
Vista frontal
Vista frontale

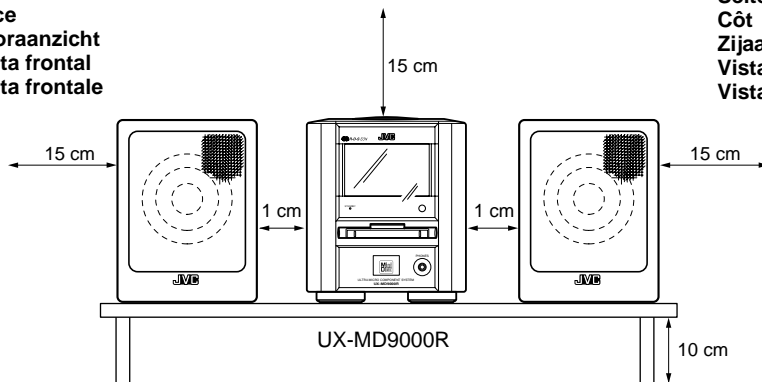

Side view
Seitenansicht
Côté
Zijaanzicht
Vista lateral
Vista laterale

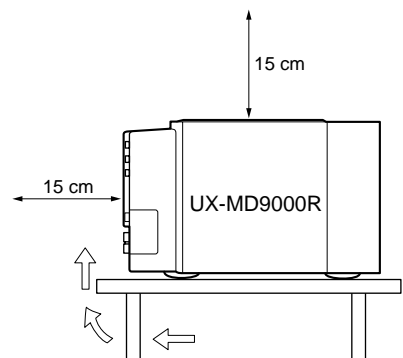

IMPORTANT FOR LASER PRODUCTS/ WICHTIGER HINWEIS FÜR LASER-PRODUKTE / IMPORTANT POUR LES PRODUITS LASER / BELANGRIJKE INFORMATIE VOOR LASERPRODUKTEN / IMPORTANTE PARA LOS PRODUCTOS LÁSER / IMPORTANTE PER I PRODOTTI LASER

REPRODUCTION OF LABELS/ANBRINGUNGSORTE FÜR LASER-PRODUKTE/REPRODUCTION DES ETIQUETTES/VERKLARING VAN DE LABELS/REPRODUCCIÓN DE ETIQUETAS/RIPRODUZIONE DELLE ETICHETTE

- | | |
|--|---|
| ① CLASSIFICATION LABEL, PLACED ON EXTERIOR SURFACE | ② WARNING LABEL, PLACED INSIDE THE UNIT |
| ① KLASSIFIZIERUNGSHINWEIS BEFINDET SICH AUF DER AUSSENSIETE | ② WARNETIKETTE IM GERÄTEINNEREN |
| ① ÉTIQUETTE DE CLASSIFICATION, PLACÉE SUR LA SURFACE EXTÉRIEURE | ② ETIQUETTE D'AVERTISSEMENT PLACÉE À L'INTERIEUR DE L'APPAREIL |
| ① CLASSIFICATIE-ETIKET AAN DE BUITENKANT VAN HET APPARAAT | ② WAARSCHUWINGSLABEL, IN HET APPARAAT |
| ① ETIQUETA DE CLASIFICACION, PROVISTA SOBRE LA SUPERFICIE EXTERIOR | ② ETIQUETA DE ADVERTENCIA, PEGADA EN EL INTERIOR DE LA UNIDAD |
| ① ETICHETTA DI CLASSIFICAZIONE POSTA ALL'ESTERNO | ② ETICHETTA DI AVVERTENZA, SITUATA ALL'INTERNO DELL'APPARECCHIO |

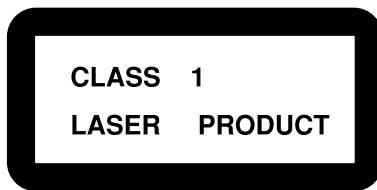

DANGER: Invisible laser radiation when open and interlock failed or defeated. AVOID DIRECT EXPOSURE TO BEAM. (e)	VARNING: Osynlig laserstrålning när denna del är öppnad och spärren är urkopplad. Beträkta ej strålen. (s)	ADVARSEL: Usynlig laserstrålning ved åbning, når sikkerhedsafbrydere er ude af funktion. Undgå udsættelse for stråling. (d)	VARO: Avattaessa ja suo-jälukitus ohitettaessa olet alttiina näkymättömälle lasersäteilylle. Älä katso säteeseen. (f)
---	---	--	--

- | | |
|---|---|
| <ol style="list-style-type: none">1. CLASS 1 LASER PRODUCT2. DANGER: Invisible laser radiation when open and interlock failed or defeated. Avoid direct exposure to beam.3. CAUTION: Do not open the top cover. There are no user serviceable parts inside the Unit; leave all servicing to qualified service personnel. | <ol style="list-style-type: none">1. KLAS 1 LASERPRODUKT2. GEVAARLIJK: Onzichtbare laserstraling wanneer open en de beveiliging faalt of uitgeschakeld is. Voorkom het direct blootstaan aan de straal.3. VOORZICHTIG: De bovenkap niet openen. Binnenin het toestel bevinden zich geen door de gebruiker te repareren onderdelen: laat onderhoud over aan bekwaam vakpersoneel. |
| <ol style="list-style-type: none">1. LASER-PRODUKT DER KLASSE 12. GEFAHR: Unsichtbare Laserstrahlung bei Öffnung und fehlerhafter oder beschädigter Spre. Direkten Kontakt mit dem Strahl vermeiden!3. ACHTUNG: Das Gehäuse nicht öffnen. Das Gerät enthält keinerlei Teile, die vom Benutzer gewartet werden können. Überlassen Sie Wartungsarbeiten bitte qualifizierten Kundendienst-Fachleuten. | <ol style="list-style-type: none">1. PRODUCTO LASER CLASE 12. PELIGRO: En el interior hay radiación láser invisible. Evite el contacto directo con el haz.3. PRECAUCIÓN: No abra la tapa superior. En el interior de la unidad no existen piezas reparables por el usuario; deje todo servicio técnico en manos de personal calificado. |
| <ol style="list-style-type: none">1. PRODUIT LASER CLASSE 12. ATTENTION: Radiation laser invisible quand l'appareil est ouvert ou que le verrouillage est en panne ou désactivé. Eviter une exposition directe au rayon.3. ATTENTION: Ne pas ouvrir le couvercle du dessus. Il n'y a aucune pièce utilisable à l'intérieur. Laisser à un personnel qualifié le soin de réparer votre appareil. | <ol style="list-style-type: none">1. PRODOTTO LASER CLASSE 12. PERICOLO: Radiazione laser invisibile quando l'apparecchio è aperto ed il dispositivo di sicurezza è guasto o disattivato. Evitare l'esposizione diretta ai raggi.3. ATTENZIONE: Non aprire il coperchio superiore. Non vi sono parti adoperabili dall'utente all'interno di questo apparecchio; lasciare tutti i controlli a personale qualificato. |

Thank you for purchasing the JVC Ultra Micro Component System.
 We hope it will be a valued addition to your home, giving you years of enjoyment.
 Be sure to read this instruction manual carefully before operating your new stereo system.
 In it you will find all the information you need to set up and use the system.
 If you have a query that is not answered by the manual, please contact your dealer.

Features

Here are some of the things that make your System both powerful and simple to use.

- The controls and operations have been redesigned to make them very easy to use, freeing you to just enjoy the music.
 - With JVC's **COMPU PLAY** you can turn on the System and automatically start the Radio, CD Player, MD Player with a single touch.
- The System incorporates Active Hyper Bass Super PRO circuitry to faithfully reproduce low frequency sounds.
- A 45-station preset capability (30 FM and 15 AM (MW/LW)) in addition to auto-seek and manual tuning.
- Versatile CD options include repeat, random and program play.
- Versatile MD Player provides playback function, recording function, editing function of the tracks in the MD, title function to give title to the MD and tracks.
- Sampling rate converter which supports 3 digital sources Incorporated.
 - 32 kHz, 44.1 kHz and 48 kHz.
- Timer functions; set the system to automatically come on, switch off.
- The System is compatible with RDS (Radio Data System) broadcasting.
 - The EON data enables you to standby for desired information.
 - The PTY Search function searches for programmes in the category you wish.
 In addition, Radio Text can be displayed using data sent by station.
- You can connect various external units, such as a CD player, tape deck, etc.



How This Manual Is Organized

- Basic information that is the same for many different functions - e.g. setting the volume - is given in the section 'Common Operations', and not repeated under each function.
- The names of buttons/controls and display messages are written in all capital letters: e.g. TUNER BAND, "NO DISC".
- System functions are written with an initial capital letter only: e.g. Normal Play.

Use the table of contents to look up specific information you require.

We've enjoyed making this manual for you, and hope it serves you in enjoying the many features built into your System.

IMPORTANT CAUTIONS

1. Installation of the System

- Select a place which is level, dry and neither too hot nor too cold. (Between 5°C and 35°C or 41°F and 95°F.)
- Leave sufficient distance between the System and a TV.
- Do not use the System in a place subject to vibrations.

2. Power cord

- Do not handle the power cord with wet hands!
- Some power is always consumed as long as the power cord is connected to the wall outlet.
- When unplugging the System from the wall outlet, always pull the plug, not the power cord.

3. Malfunctions, etc.

- There are no user serviceable parts inside. In case of system failure, unplug the power cord and consult your dealer.
- Do not insert any metallic object into the System.

Table of Contents

Features	1	Using the Timers	22
How This Manual Is Organized	1	Information on MDs (Minidisks).....	23
IMPORTANT CAUTIONS	1	MD (Minidisc) Error Messages	24
Getting Started	2	Minidisc limitations	25
Common Operations	6	Rules of Digital Dubbing.....	25
Using the Tuner	8	Care And Maintenance	26
Using the CD Player	11	Troubleshooting	27
Using the MD Player (Listening to an MD)	13	Specifications	28
Recording onto an MD	15		
Using the MD Player (Editing)	16		
Using External Equipments	21		

Getting Started

Accessories

Check that you have all of the following items, which are supplied with the System.

- Power Cord (1)
- AM Loop Antenna (1)
- Remote Control (1)
- Batteries (2)
- FM Wire Antenna (1)
- Speaker Cords (2)
- Polishing Cloth (1)

If any of these items are missing, contact your dealer immediately.

How To Put Batteries In the Remote Control

Match the polarity (+ and –) on the batteries with the + and – markings in the battery compartment.

R6P(SUM-3)/AA(15F)

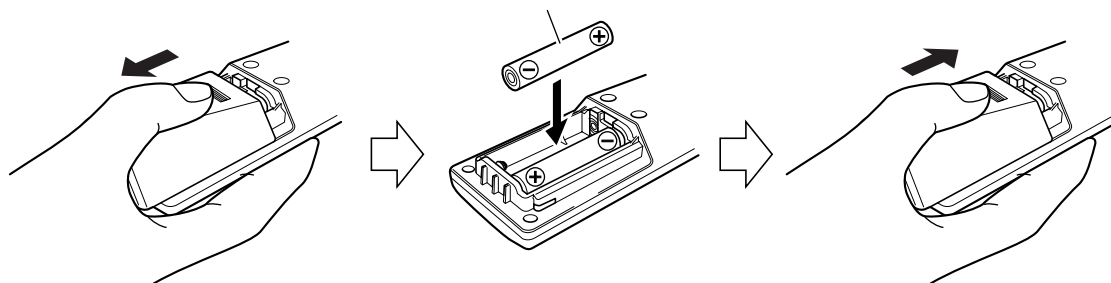

CAUTION: Handle batteries properly.

To avoid battery leakage or explosion:

- Remove batteries when the Remote Control will not be used for a long time.
- When you need to replace the batteries, replace both batteries at the same time with new ones.
- Don't use an old battery with a new one.
- Don't use different types of batteries together.

Using the Remote Control

The Remote Control makes it easy to use many of the functions of the System from a distance of up to 7m (23 feet) away. You need to point the Remote Control at the remote sensor on the System's front panel.

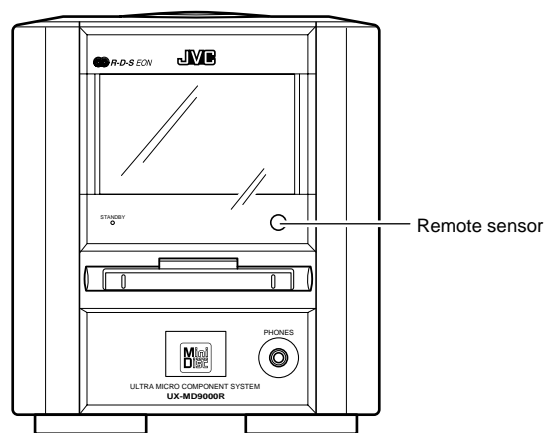

CAUTION: Make all connections before plugging the System into an AC power outlet.

Connecting the FM Antenna

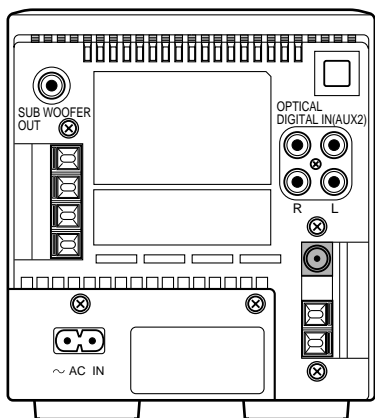

Using the Supplied Wire Antenna

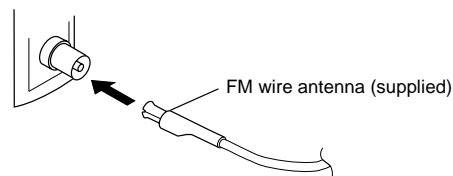

Using the Coaxial Type Connector (Not Supplied)

A 75-ohm antenna with coaxial type connector (IEC or DIN45 325) should be connected to the FM 75-ohm COAXIAL terminal.

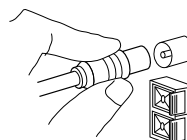

If reception is poor, connect the outside antenna.

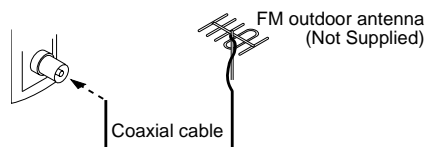

Note: Before attaching a 75 ohm coaxial lead (the kind with a round wire going to an outside antenna), disconnect the supplied FM Wire Antenna.

CAUTION: To avoid noise, keep antennas away from the System, the connecting cord and the AC power cord.

Connecting the AM (MW/LW) Antenna

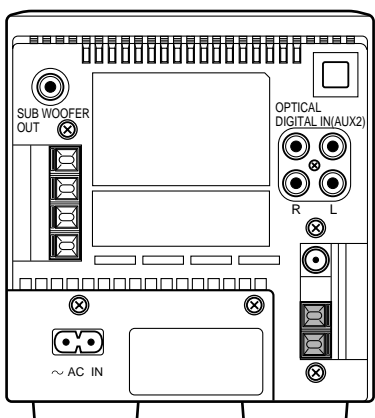

AM loop antenna (Supplied)

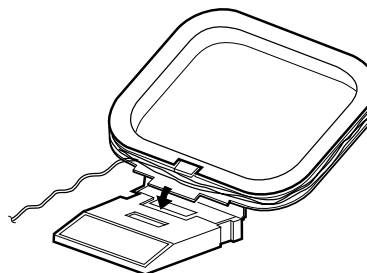

Attach the AM loop to its base by snapping the tabs on the loop into the slot in the base.

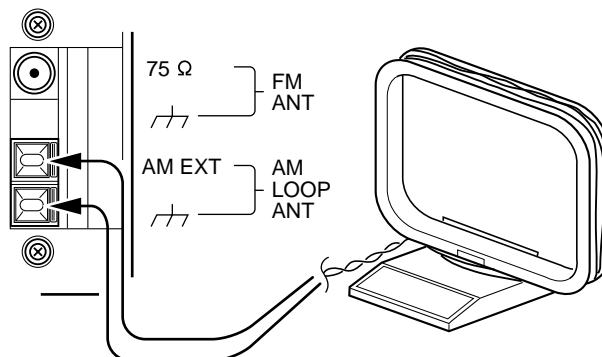

Turn the loop until you have the best reception.

CAUTION: Make all connections before plugging the System into an AC power outlet.

Connecting the Speakers

1. Open each of the terminals to connect the speaker wire leads.
2. Connect the speaker cords between the Speaker terminals of the Unit and the terminals of the Speakers. Connect the cords with a black line to the (–) terminals and cords without a black line to the (+) terminals.
3. Close each of the terminals to securely connect the cords.

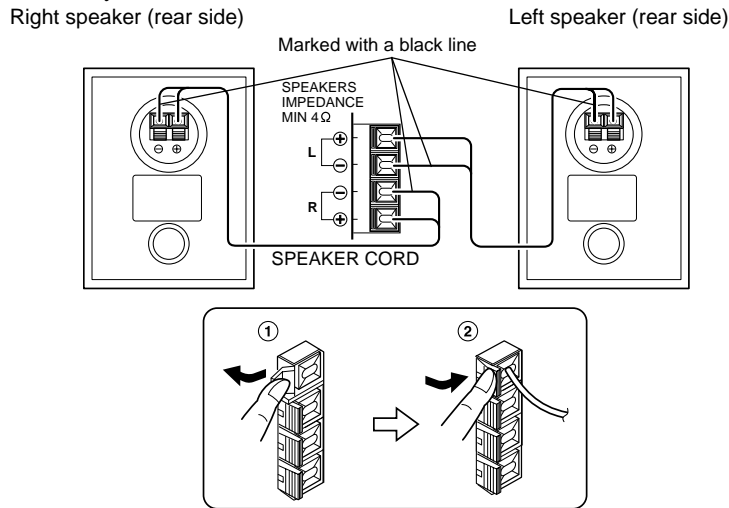

CAUTION: A TV may display irregular colors if located near the speakers. If this happens, set the speakers away from the TV.

Removing the speaker grilles

The speaker grilles can be removed.

When removing,

1. Insert your fingers at the top and pull towards you.
2. Also pull the bottom towards you.

Attaching the speaker grille

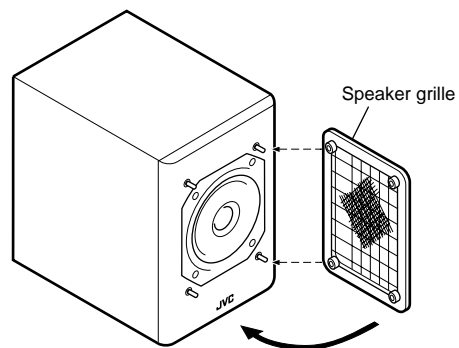

Connecting External Equipment

Connecting a Tape Deck, etc.

Connect (not supplied) signal cords between the System's LINE IN (AUX1)/OUT terminals and the output/input terminals of the external tape deck, etc.

You can listen to one of these sources. Also, you can record the System's CD Player, MD Player, or tuner output signal to the external tape deck, etc..

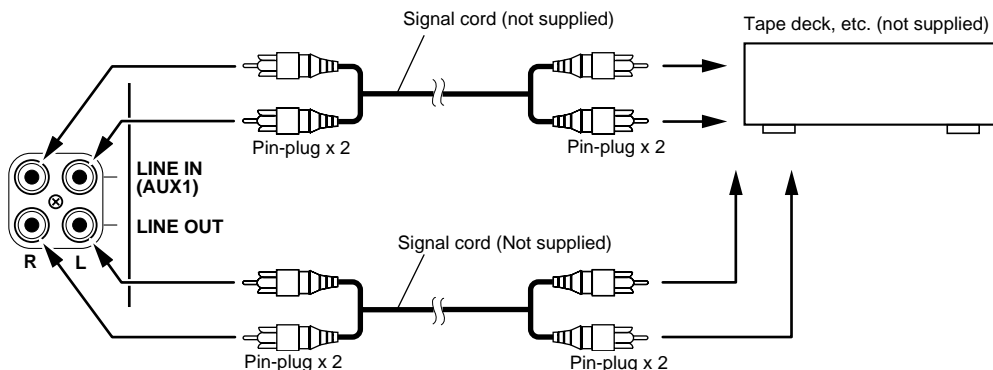

CAUTION: Make all connections before plugging the System into an AC power outlet.

Connecting Auxiliary Equipment

Connect an (not supplied) signal cord between the LINE IN (AUX1) terminals on the System and the output terminals of your auxiliary equipment (e.g. turntable). You can listen to this source.

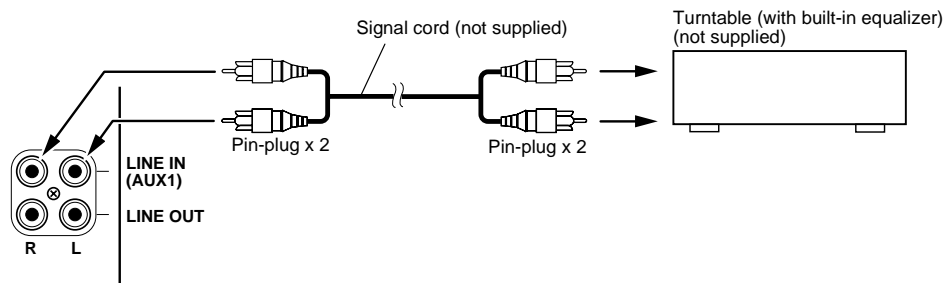

Connecting a CD Player, etc (Digital Input (AUX2))

Unplug the cap and connect an (not supplied) optical digital cord between the System's OPTICAL DIGITAL IN (AUX2) terminal and the output terminal of the CD player, etc.

You can listen to the digital input signal from the CD player, etc.

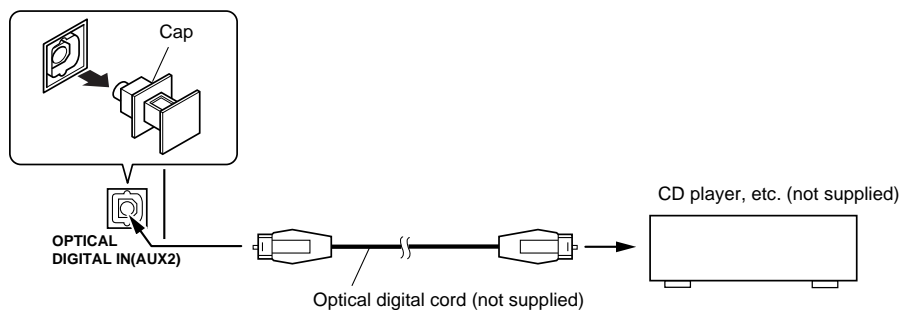

Connecting a Subwoofer System

Connect an (not supplied) signal cord between the SUB WOOFER OUT terminal and an external JVC subwoofer system, etc.

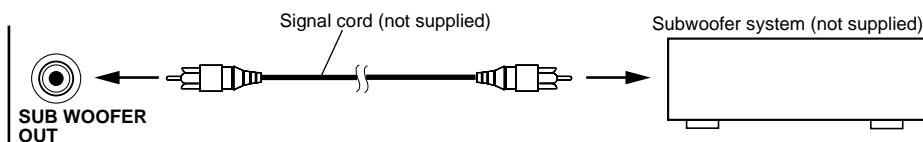

Connecting the AC Power Cord

Firmly insert the supplied AC power cord into the AC inlet on the back of the Unit.

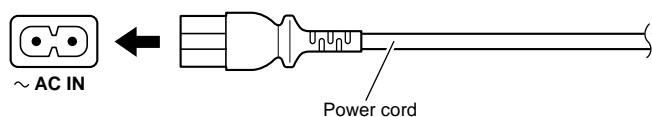

CAUTIONS:

- **ONLY USE THE JVC POWER CORD PROVIDED WITH THIS SYSTEM TO AVOID MALFUNCTION OR DAMAGE TO THE SYSTEM.**
- **BE SURE TO UNPLUG THE POWER CORD FROM THE OUTLET WHEN GOING OUT OR WHEN THE SYSTEM IS NOT IN USE FOR AN EXTENDED PERIOD OF TIME.**

Now you can plug the AC power cord into the wall outlet, and your System is at your command!!

COMPU PLAY

JVC's COMPU PLAY feature lets you control the most frequently used System functions with a single touch.

With One Touch Operation you can play a CD, an MD, or turn on the radio with a single press of the play button for that function. One Touch Operation turns the power on for you, then starts the function you have specified. If the System is not ready (no CD in place, for example), the System still powers on so you can insert a CD.

How One Touch Operation works in each case is explained in the section dealing with that function.

The COMPU PLAY buttons are:

On the Unit

CD ►|| button
TUNER BAND button
MD ►|| button
TAPE/AUX button

On the Remote Control

CD ►|| button
TUNER BAND button
MD ►|| button
TAPE/AUX button

AUTOMATIC POWER ON

The System automatically turns on with the following operation.

- When you press the CD ▲ button, the System automatically turns on and the CD holder opens to allow CD insertion. However, this operation does not change the function to CD.
When you press the ⏻ button to turn off the System, the CD holder will automatically closed if it is opened.
- When you insert an MD, the System automatically turns on. However, this operation does not change the function to MD.

Common Operations

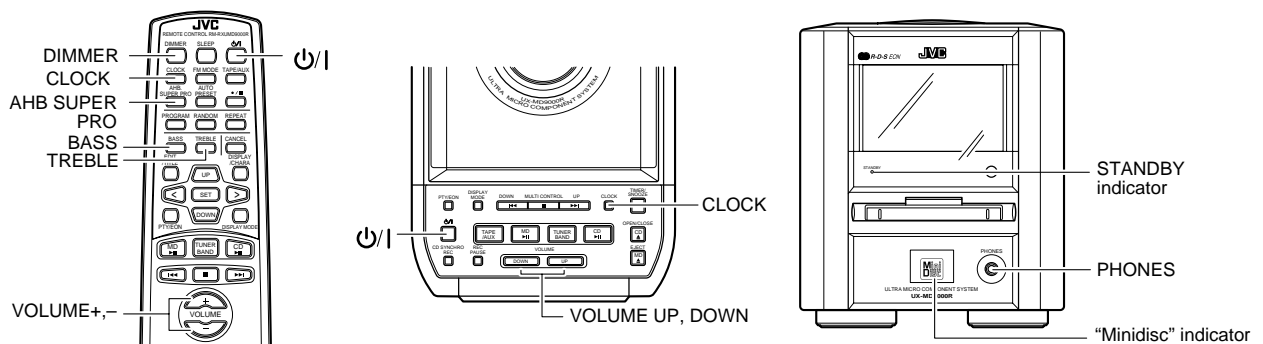

Turning the Power On and Off

Turning the System On

Press the ⏻ button.

The display comes on and the STANDBY indicator goes out.

The System comes on ready to continue in the mode it was in when the power was last turned off.



- For example, if the last thing you were doing was listening to a CD, you are now ready to listen to a CD again. If you wish, you can change to another source.
- If you were listening to the Tuner last, the Tuner comes on playing the station it was last set to.

Turning the System Off

Press the ⏻ button again.

The "STANDBY" indicator lights up and the display is blank, except for the clock display.



- Some power (5W) is always consumed even though power is turned off (called Standby Mode).
- To switch off the System completely, unplug the AC power cord from the AC outlet. When you unplug the AC power cord, the clock will be reset to 0:00 after about 20 minutes, and preset Tuner stations will be erased after about 24 hours.

Adjusting the Brightness (DIMMER)

You can adjust the brightness of the display in three levels.

To change the brightness, press the DIMMER button on the Remote Control.

Each time you press the DIMMER button, the brightness changes as follows.

Bright (Level 1) → Dark (Level 2) → Darker (Level 3) → (back to the beginning)

- When the System is turned on, the display brightens with the Level 1.
- The "Minidisc" indicator will go out in Level 3.

Adjusting the Volume

You can adjust the volume level between 0 and 50.
The VOLUME indicator on the display indicates the volume level.



Press the VOLUME UP button of the Unit to increase the volume or press the VOLUME DOWN button to decrease it.

OR

Press the VOLUME + button on the Remote Control to increase the volume or press the VOLUME - button to decrease it.

CAUTION: DO NOT start playing any source without first setting the VOLUME control to minimum position, as a sudden blast of sound can damage your hearing, speakers and/or headphones.

For private listening

Connect a pair of headphones to the PHONES jack. No sound comes out of the speakers.

Be sure to turn down the volume before connecting or putting on headphones.

Reinforcing the Bass Sound (AHB SUPER PRO)

You can reinforce the bass sound to maintain rich, full bass at low volume (you can use this effect only for playback):

To get the effect, press the AHB (Active Hyper Bass) SUPER PRO button on the Remote Control.

The "BASS" indicator lights up on the display.

To cancel the effect, press the button again.

The "BASS" indicator goes out.

Tone Control (BASS/TREBLE)

You can control the tone by changing the bass and treble.

BASS Control

You can adjust the bass level (low frequency range level) between -6 and +6. (0: Flat)

1. Press the BASS button on the Remote Control.

2. Press the UP or DOWN button on the Remote Control to adjust the bass level.

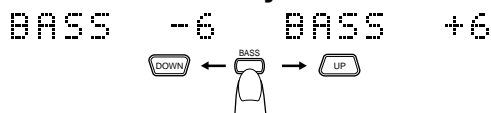

TREBLE Control

You can adjust the treble level (high frequency range level) between -6 and +6. (0: Flat)

1. Press the TREBLE button on the Remote Control.

2. Press the UP or DOWN button on the Remote Control to adjust the treble level.

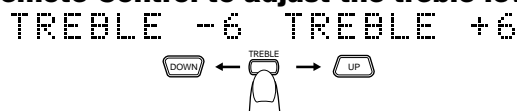

- The bass or treble level display goes out when the BASS or TREBLE button is pressed again or when nothing is done for about 6 seconds.

Showing the Time (CLOCK)

In Standby mode, the clock appears on the display.

When the System is turned on, you can display the clock at any time.

To display the clock, press the CLOCK button.

To light off the clock, press the CLOCK button again.



Note: To let work the clock, you need to set the clock beforehand. (See "Setting the Clock" on page 22.)

Using the Tuner

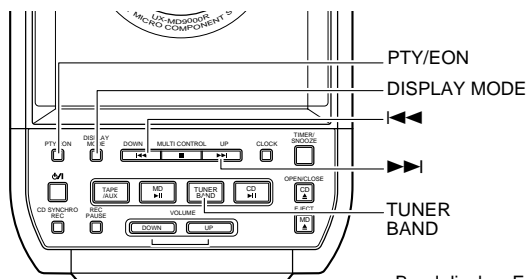
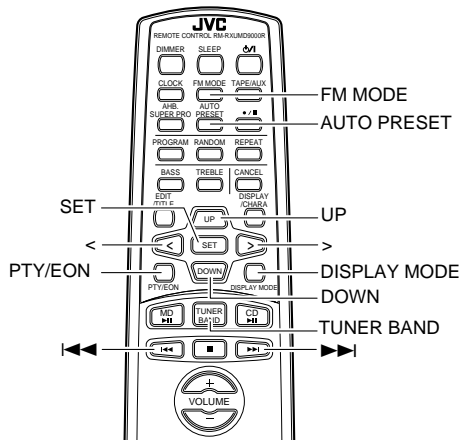

When the System is in use, the display shows other items as well. For simplicity, we show here only the items described in this section.

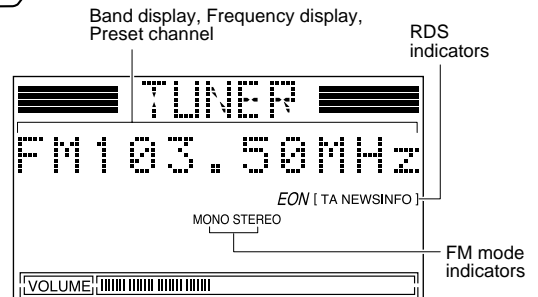

You can listen to FM and AM (MW/LW) stations. Stations can be tuned in manually, automatically, or from preset memory storage.

■ Before listening to the radio:

- Check that both the FM and AM (MW/LW) antennas are correctly connected. (See page 3).

One Touch Radio

Just press the TUNER BAND button to turn on the System and start playing the station you were last tuned to.

- You can switch from any other sound source to the radio by pressing the TUNER BAND button.

Tuning In a Station

1. Press the TUNER BAND button.

The Band and Frequency you were last tuned to appear on the display.

Each time you press the button, the band alternates between FM and AM (MW/LW).

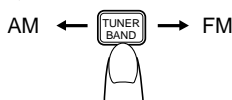

2. Select a station using one of the following methods.

■ Manual Tuning

Press the <<< or >>> button repeatedly to move from frequency to frequency until you find the station you want.

OR

■ Auto Tuning

If you press and hold the <<< or >>> button for one second or more, the frequency changes down, or up, automatically until a station is found.

OR

■ Preset Tuning using the Remote Control (Possible only after presetting stations)

Select the desired preset number using the UP, DOWN, >, and < buttons on the Remote Control. After 1 second the display will show the preset number's band and frequency.

UP button: Increases the preset number by 1.

DOWN button: Decreases the preset number by 1.

> button: Increases the tenth digit for preset number.

< button: Decreases the tenth digit for preset number.

Example: For program number 12, press the > button, then press the UP button twice (or simply press the UP button 12 times.).

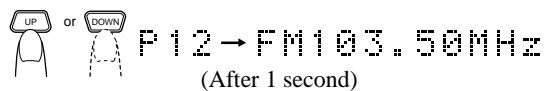

Presetting Stations

You can preset up to 30 FM stations and up to 15 AM (MW/LW) stations using the Remote Control.

Note: Preset numbers may have been set to factory test frequencies prior to shipment. This is not a malfunction. You can preset the stations you want into memory by following one of the presetting methods below.

Manual Presetting

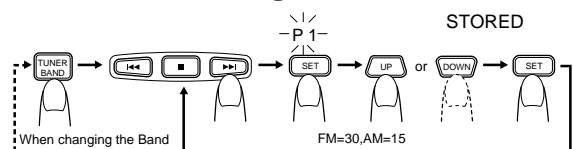

1. Select a band by pressing the TUNER BAND button.

2. Press the <<< or >>> button to tune in a station.

3. Press the SET button.

"P 1" will blink.

4. Press the UP, DOWN, >, or < button to select the preset number.

UP button: Increases the preset number by 1.

DOWN button: Decreases the preset number by 1.

> button: Increases the tenth digit for preset number.

< button: Decreases the tenth digit for preset number.

5. Press the SET button.

"STORED" appears and, after 1 second, the display returns to the broadcast frequency display.

6. Repeat above steps 1 to 5 for each station you want to store in memory with a preset number.

To cancel the presetting, press the CANCEL button in step 3 or 4.

To change the preset stations, repeat the same steps as above.

Auto Presetting

In each band, you can automatically preset FM-30, AM (MW/LW)-15 stations. Preset numbers will be allocated as stations are found, starting from the lowest station and moving up the frequency.

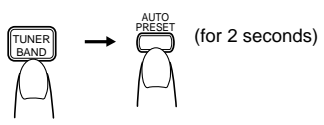

1. Select a band by pressing the **TUNER BAND** button.
2. Press the **AUTO PRESET** button on the Remote Control for more than two seconds.
3. Repeat steps 1-2 for the other band.

If you want to change the preset stations, carry out the Manual Presetting for the desired preset numbers.

CAUTION: If the System is unplugged or if a power failure occurs, the preset stations will be erased after about 24 hours. If this happens, you will need to preset the stations again.

To Change the FM Reception Mode

When you are tuned in an FM broadcast, the "STEREO" indicator lights up and you can hear stereo effects.

If an FM stereo broadcast is hard to receive or noisy, you can select Monaural mode. Reception improves, but you lose any stereo effect.

Press the **FM MODE** button on the Remote Control so that the "MONO" indicator lights up on the display.

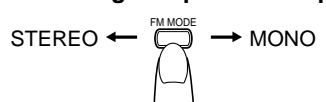

To restore the stereo effect, press the **FM MODE** button on the Remote Control so that the "MONO" indicator goes off.

Receiving FM Stations with RDS

You can use the RDS (Radio Data System) by using the buttons on the Unit or the Remote Control.

RDS allows FM stations to send additional signals with their regular programme signals. For example, the stations send their station names, and information about what type of programmes they broadcast, such as sports or music, etc. This unit can receive the following types of RDS signals:

- PS (Programme Service):** shows commonly known station names.
- PTY (Programme Type):** shows types of broadcast programmes.
- RT (Radio Text):** shows text messages the station sends.
- TA (Traffic Announcement):** shows traffic announcements being broadcast.

What information can RDS signals provide?
The display shows RDS signal information that the station sends.

To show the RDS signals on the display

Press the **DISPLAY MODE** button while listening to an FM station.

Each time you press the button, the display changes to show information in the following order:

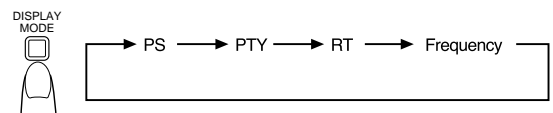

- PS (Programme Service):** While searching, "PS" appears, then station name is displayed. "NO PS" appears if no signal is sent.
- PTY (Programme Type):** While searching, "PTY" appears, then broadcast programme type is displayed. "NO PTY" appears if no signal is sent.
- RT (Radio Text):** While searching, "RT" appears, then a text message sent by the station is displayed. "NO RT" appears if no signal is sent.
- Station Frequency:** Station frequency (non-RDS service)

- Notes:**
- If searching finishes at once, "PS", "PTY" and "RT" will not appear on the display.
 - If you press the **DISPLAY MODE** button while listening to an AM (MW/LW) station, the display only shows station frequency.
 - RDS is not available for AM (MW/LW) broadcasts.

On characters displayed

- When the display shows PS, PTY or RT signals:
- The display cannot show accented letters; For example, "A" may represent accented "A's" like "Á, Â, Ã, Ä, Å and Ă".

[Example]

A	Á, Â, Ã, Ä, Å, Ă	K	K	U	U, Ú, Ó, U, Ü	0	0	#	*	<	<
B	B	L	L	V	V	1	1	+	+	>	>
C	Č, Ć, Ć	M	M	W	W	2	2	-	-	=	=
D	D, Đ	N	N, Ñ	X	X	3	3	'	'	\	\
E	É, Ê, Ë, E, E	O	O, Ó, Ô, Ö, Ø	Y	Y	4	4	'	'	'	'
F	F	P	P	Z	Z, Ž, Ž	5	5	/	/		
G	G	Q	Q			6	6	-	-		
H	H	R	R, Ř, Ř			7	7	-	-		
I	Í, Î, Î	S	S, Ś, Ś			8	8	-	-		
J	J	T	T			9	9				

To search for a programme by PTY codes

One of the advantages of the RDS service is that you can locate a particular kind of programme by specifying the PTY codes.

To search for a programme using PTY or TA codes:

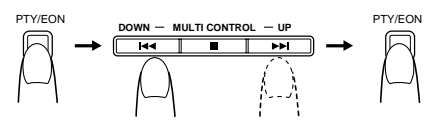

1. Press the **PTY/EON** button once while listening to an FM station.
"SELECT PTY" appears on the display.
2. Select the **PTY** code using the **◀◀** or **▶▶** button (or **UP** or **DOWN** button on the Remote Control) within 10 seconds.
Each time you press the button, the display shows a category in the following order:

NEWS ↔ AFFAIRS ↔ INFO ↔ SPORT ↔ EDUCATE ↔ DRAMA ↔ CULTURE ↔ SCIENCE ↔ VARIED ↔ POP M

↔ROCK M↔M.O.R.M↔LIGHT M↔CLASSICS↔OTHER M↔WEATHER↔FINANCE↔CHILDREN↔SOCIAL A↔RELIGION↔PHONE IN↔TRAVEL↔LEISURE↔JAZZ↔COUNTRY↔NATIONAL↔OLDIES↔FOLK M↔DOCUMENT↔TRAFFIC↔NEWS

3. Press the PTY/EON button within 10 seconds again.

While searching, the display alternates between "SEARCH" and the selected PTY code.

The unit searched preset stations and stops when it finds a station of the category you have selected, then tunes into that station.

If no programme is found, "NOT FOUND" appears on the display.

To continue searching after the first stop, press the PTY button again while the display indications blink.

To stop searching at any time during the process

Press the PTY button to stop search operation.

Note: Station will change from the current one.

Descriptions of the PTY Codes

NEWS:	News
AFFAIRS:	Topical programme expanding on the current news or affairs
INFO:	Programmes on medical service, weather forecasts, etc.
SPORT:	Sports events
EDUCATE:	Educational programmes
DRAMA:	Radio plays
CULTURE:	Programmes on national or regional culture
SCIENCE:	Programmes on natural sciences and technology
VARIED:	Other programmes like comedies or ceremonies
POP M:	Pop music
ROCK M:	Rock music
M.O.R.M:	Middle-of-the-road music (usually called "easy listening")
LIGHT M:	Light music
CLASSICS:	Classical music
OTHER M:	Other music
WEATHER:	Weather information
FINANCE:	Reports on commerce, trading, the Stock Market, etc.
CHILDREN:	Entertainment programmes for children
SOCIAL A:	Programmes on social activities
RELIGION:	Programmes dealing with any aspect of belief or faith, or the nature of existence or ethics
PHONE IN:	Programmes where people can express their views either by phone or in a public forum
TRAVEL:	Programmes about travel destinations, package tours, and travel ideas and opportunities
LEISURE:	Programmes concerned with recreational activities such as gardening, cooking, fishing, etc.
JAZZ:	Jazz music
COUNTRY:	Country music
NATIONAL:	Current popular music from another nation region, in that country's language
OLDIES:	Classic pop music
FOLK M:	Folk music
DOCUMENT:	Programmes dealing with factual matters, presented in an investigative style
TRAFFIC:	Broadcasts which carry traffic announcements

To temporarily switch to a broadcast programme of your choice

EON (Enhanced Other Networks) is another convenient RDS service that allows this unit to switch temporarily to a broadcast programme of your choice (NEWS, TA or INFO) from the currently selected station, except if you are listening to a non-RDS station (all AM (MW/LW) stations or some FM stations).

- If an FM station does broadcast EON information, EON cannot be activated.

To select a programme type

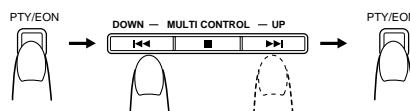

1. Press the PTY/EON button twice while listening to an FM station.

"SELECT EON" appears on the display.

2. Select the programme type with the ◀◀ or ▶▶ button (or UP or DOWN button on the Remote Control) within 10 seconds.

The display shows a programme type in the following order:



TA: Traffic Announcement

NEWS: News

INFO: Programmes on medical service, weather forecast, etc.

OFF: EON off

3. Press the PTY/EON button within 10 seconds again to set the selected programme type.

The selected programme type indicator lights up on the display, and the unit enters EON Standby mode.

- The EON indicator lights up when tuned to a station which provides EON information.

If there is no station broadcasting the type of programme you have selected

The broadcast station being currently heard will continue to be heard.



When a station starts broadcasting the programme you have selected, this unit automatically switches to the station. The programme type (TA, NEWS or INFO) indicator starts blinking.



When the programme is over, this unit goes back to the currently selected station, but still remains in EON Standby mode.

Notes:

- If the EON is in standby mode and the function (CD, MD, TAPE/AUX) switch is changed or the power is switched off, then the EON mode will be released. When the band is set to AM (MW/LW), the EON is not activated. When the band is set to FM again, the EON will be set to standby mode.
- When the EON is being operated (i.e. the selected programme type is being received from the broadcast station) and if the ◀◀, ▶▶ button is operated, the station will not switch back to the current selected station even after the programme ends. The programme type indicator remains in the display, indicating that the EON is in standby mode.
- When the EON is in standby mode and a radio broadcast is being recorded, be careful because the EON may be activated and a different programme than the intended one may be recorded. When the EON mode is not required, release the EON mode.
- When the alarm signal is detected by EON, the station broadcasting the alarm is received with priority. "ALARM" is not displayed.

Caution:

When the sound alternated intermittently between the station tuned in by the EON function and the current selected station, cancel the EON mode. This does not constitute malfunction of the unit.

Using the CD Player

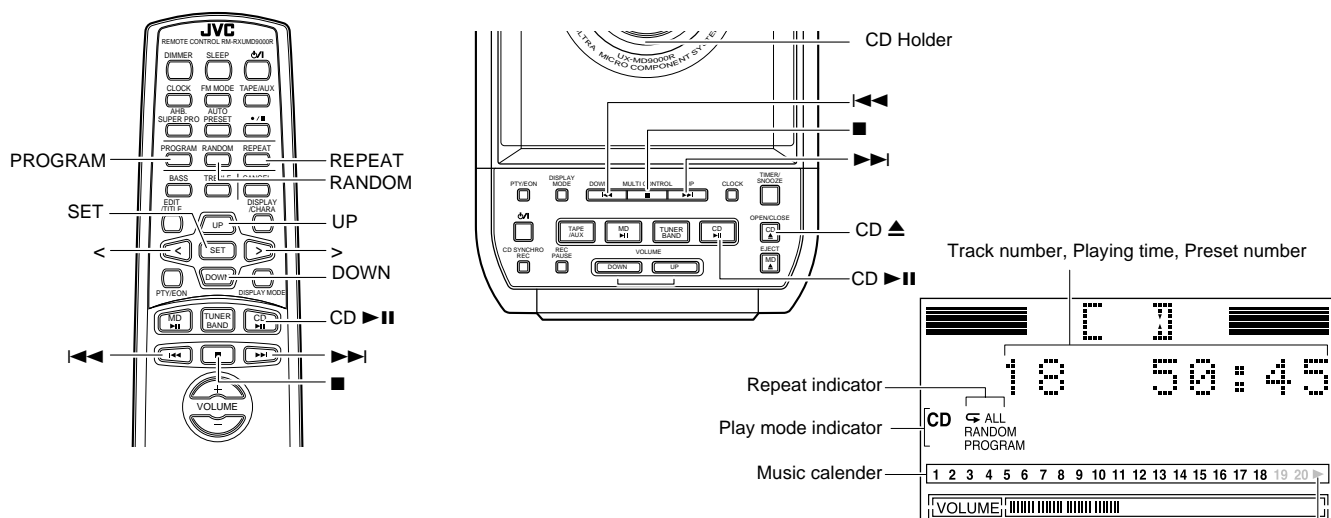

You can use Normal, Random, Program or Repeat Play. Repeat Play can repeat all the tracks or just one of the tracks on the CD. Here are the basic things you need to know to play a CD and locate the different tracks on it.

The Quickest Way To Start a CD Is With the One Touch Operation

- Press the CD ►► button.
- The power is automatically turned on. If a CD is already inserted, it will start playing from the first track.
- If no CD is inserted, "NO DISC" appears on the display and the CD Player remains in Stop mode.

To Insert a CD

1. Press the CD ▲ button on the Unit.

The CD holder opens.

2. Place a CD, with its label side up as shown below.

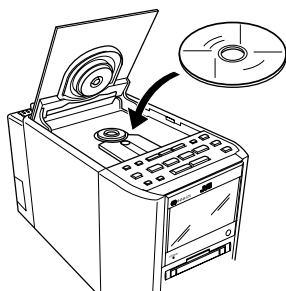

3. Press the CD ▲ button again to close the CD holder.

- To close the CD holder and play the CD, you can press the CD ►► button.
- You can place an 8 cm (3") CD without an adaptor.
- If the CD cannot be read correctly (because it is scratched, for example), "0 0:00" appears on the display.
- You can insert a CD while listening to the other source.

Basics of Using the CD Player-Normal Play

To Play a CD

1. Insert a CD.

2. Press the CD ►► button.

The first track of the CD begins playing.

1 0:05
Track number Playback time

- The track number that has been played disappears from the music calendar.
- The CD Player automatically stops when the last track of the CD has finished playing.

To stop playing the CD, press the ■ button.

The following information for the CD is displayed.

18 50:45
Total track number Total playback time

To stop playing and remove the CD, press the CD ▲ button to open the CD holder.

To pause, press the CD ►► button. The playback time blinks on the display.

To cancel pause, press the same button again. Play continues from the point where it was paused.

To Select a Track or Passage within a Track

During playback, press the ◀◀ or ▶▶ button to select the track you want.

The selected track starts playing.

- Press the ▶▶ button once to skip to the beginning of the next track.
- Press the ◀◀ button to skip to the beginning of the track being played. Press twice quickly to skip to the beginning of the previous track.

Search Play

Holding down the ◀◀ or ▶▶ button, during playback, will fast forward/backwards the CD so you can quickly find a particular passage in the track you are listening to.

Programming the Playing Order of the Tracks

You can program the playing order of the tracks using the Remote Control.

- You can program up to 20 tracks in any desired order including the same tracks.
- You can only make a program when the CD Player is stopped.

- 1. Insert a CD.**
- 2. Press the CD ►|| button.**
- 3. Press the ■ button to stop the CD.**
- 4. Press the PROGRAM button.**

The System enters the programming mode and the "CD PROGRAM" indicator lights up.



- 5. Press the UP, DOWN, >, or < button to select the track to program.**

- UP button: Increases the track number by 1.
- DOWN button: Decreases the track number by 1.
- > button: Increases the tenth digit of the track number.
- < button: Decreases the tenth digit of the track number.
- Example: for track 2, press the UP button twice. For track 12, press the > button, then press the UP button twice (or simply press the UP button 12 times).

- 6. Press the SET button.**

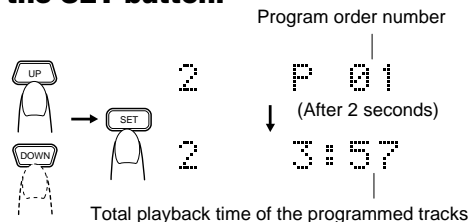

- 7. Repeat steps 5 and 6 to select the other tracks for the program.**

You can see the total playback time of programmed tracks on the display. Also, you can see the programmed tracks on the music calendar.

- 8. Press the CD ►|| button.**

The System plays the tracks in the order you have programmed them.

- You can skip to a particular program track by pressing the ◀◀ or ▶▶ button during Program Play.
- To stop playing, press the ■ button once.

To confirm the programmed tracks while the CD player is stopped, press the ◀◀ or ▶▶ button; the tracks making up the program will successively be displayed in the programmed order.

To delete all the tracks in the program, press the ■ button repeatedly until all the tracks are cleared. Turning off the power or pressing the CD ▲ button to open the CD holder will also clear the programmed tracks.

To exit the program mode once, while the CD Player is stopped, press the PROGRAM button to light off the "CD PROGRAM" indicator.

Note: If the total playback time of the programmed tracks exceeds 99 minutes 59 seconds, the total playback time will go out on the display.

To Modify the Program

Modify the contents of the program while the CD Player is stopped. Each time you press the ■ button, the last track in the program is deleted. To add new tracks to the end of the program, repeat above steps 5 to 7.

Random Play

The tracks will play in no special order when you use this mode.

- 1. Press the RANDOM button on the Remote Control.**

The "CD RANDOM" indicator lights up on the display.

- 2. Press the CD ►|| button.**

The tracks are played in random order.

To skip a track during playback, press the ▶▶ button to jump to the next track in the random sequence. Press the ◀◀ button to jump back to the start of a track being played.

To exit Random Play mode, press the RANDOM button to light off the "CD RANDOM" indicator and carry out Normal Play or Program Play, or press the CD ▲ button to open the CD holder.

Repeating Tracks

You can set the program or individual track playing to repeat as many times as you like.

Press the REPEAT button on the Remote Control.

The Repeat indicator changes with each press of the button, as shown below.

◀ → ◀ **ALL** → blank display → (back to the beginning)

◀ : Repeats one track.

◀ **ALL** : In Normal Play mode, repeats all the tracks.

In Program Play mode, repeats all the tracks in the program.

In Random Play mode, repeats all the tracks in random order.

To exit Repeat mode, press the REPEAT button until the Repeat indicator on the display goes out.

- In Random Play, as a matter of course, ◀ cannot be selected.

- Repeat mode remains on the display even when you change the play mode.

Search Play

Holding down the ◀◀ or ▶▶ button, during playback, will fast forward/backwards the MD so you can quickly find a particular passage in the track you are listening to.

Programming the Playing Order of the Tracks

You can program the playing order of the tracks using the Remote Control.

- You can program up to 32 tracks in any desired order including the same tracks.
- You can only make a program when the MD Player is stopped.

1. **Insert an MD.**
2. **Press the MD ▶|| button.**
3. **Press the ■ button to stop the MD.**
4. **Press the PROGRAM button.**

The System enters the programming mode and the "MD PROGRAM" indicator lights up.



5. **Press the UP, DOWN, >, or < button to select the track to program.**

- UP button: Increases the track number by 1.
- DOWN button: Decreases the track number by 1.
- > button: Increases the tenth digit of the track number.
- < button: Decreases the tenth digit of the track number.
- Example: for track 2, press the UP button twice. For track 12, press the > button, then press the UP button twice (or simply press the UP button 12 times).

6. **Press the SET button.**

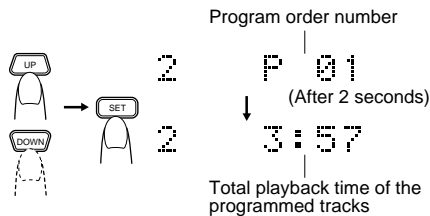

7. **Repeat steps 5 and 6 to select the other tracks for the program.**

You can see the total playback time of programmed tracks on the display. Also, you can see the programmed tracks on the music calendar.

8. **Press the MD ▶|| button.**

The System plays the tracks in the order you have programmed them.

- You can skip to a particular program track by pressing the ◀◀ or ▶▶ button during Program Play.
- To stop playing, press the ■ button.

To confirm the programmed tracks while the MD Player is stopped, press the ◀◀ or ▶▶ button; the tracks making up the program will successively be displayed in the programmed order.

To delete all the tracks in the program, press the ■ button repeatedly until all the tracks are cleared. Turning off the power or pressing the MD ▲ button to eject the MD will also clear the programmed tracks.

To exit the program mode once, while the MD Player is stopped, press the PROGRAM button to light off the "MD PROGRAM" indicator.

Note: If the total playback time of the programmed tracks exceeds 150 minutes, the total playback time will go out on the display.

To Modify the Program

Modify the contents of the program while the MD Player is stopped. Each time you press the ■ button, the last track in the program is deleted. To add new tracks to the end of the program, repeat above steps 5 to 7.

Random Play

The tracks will play in no special order when you use this mode.

1. **Press the RANDOM button on the Remote Control.**

The "MD RANDOM" indicator lights up on the display.

2. **Press the MD ▶|| button.**

The tracks are played in random order.

To skip a track during playback, press the ▶▶ button to jump to the next track in the random sequence. Press the ◀◀ button to jump back to the start of a track being played.

To exit Random Play mode, press the RANDOM button to light off the "MD RANDOM" indicator and carry out Normal Play or Program Play, or press the MD ▲ button to eject the MD.

Repeating Tracks

You can set the program or individual track playing to repeat as many times as you like.

Press the REPEAT button on the Remote Control.

The Repeat indicator changes with each press of the button, as shown below.

- ↺ → ↺ **ALL** → blank display → (back to the beginning)
- ↺ : Repeats one track.
- ↺ **ALL** : In Normal Play mode, repeats all the tracks.
In Program Play mode, repeats all the tracks in the program.
In Random Play mode, repeats all the tracks in random order.

To exit Repeat mode, press the REPEAT button until the Repeat indicator on the display goes out.

- In Random Play, as a matter of course, ↺ cannot be selected.
- Repeat mode remains on the display even when you change the play mode.

Recording onto an MD

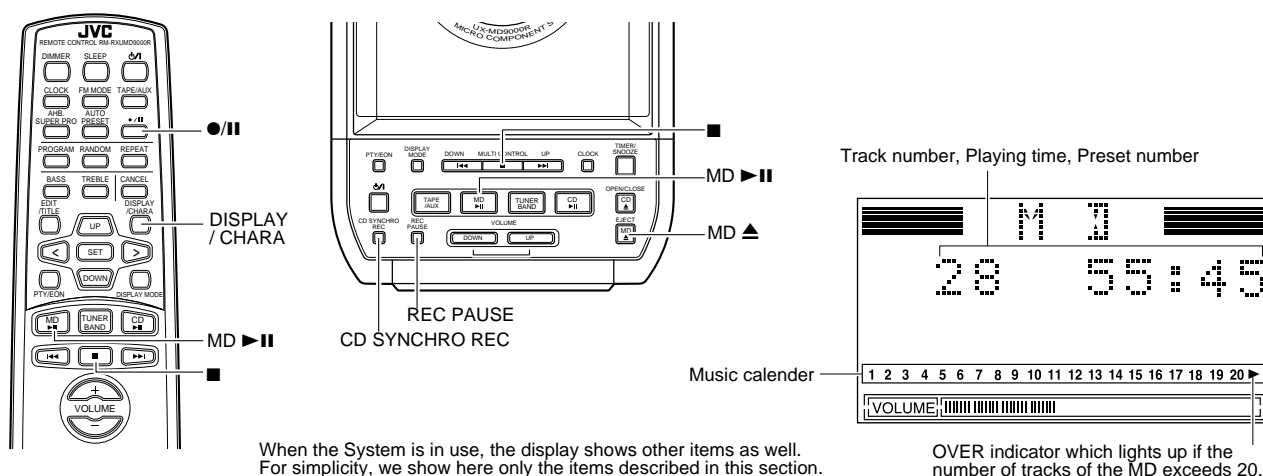

When the System is in use, the display shows other items as well. For simplicity, we show here only the items described in this section.

OVER indicator which lights up if the number of tracks of the MD exceeds 20.

Recording onto an MD from any of the sound sources is simple. Just insert an MD to the Unit, have the source ready, make one or two settings, and you are ready to record. For each source, the procedure is a little bit different so we explain each separately. But first, here are a few things to make your recordings better.

Things To Know Before You Start

Recording

- It may be unlawful to record or play back copyrighted material without the consent of the copyright owner.
- Carefully read the "Rules of Digital Dubbing" on page 25.
- The MD Recorder supports the following sampling frequencies for digital sources.
For the OPTICAL DIGITAL IN (AUX2): 32 kHz, 44.1 kHz and 48 kHz.
For the CD Player of the Unit: 44.1 kHz.
- The recording level, which is the volume at which the new MD is being made, is automatically set correctly, so it is not affected by the VOLUME level of the System. Nor it is affected by adjusting the sound effects. Thus, during recording you can adjust the sound you are actually listening to without affecting the recording level.
- The accidental erasure prevention knob is provided on the back of an MD cartridge to prevent accidental erasure or recording. It must be set to the close position beforehand.

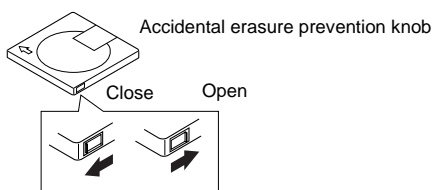

- When you stick an adhesive label onto the MD cartridge, adhere it securely. If it peels off, ejection trouble, etc. will occur.

Preparation Before Recording

- Be sure that the MD is not the Play-only type one.
- Be sure that the accidental erasure prevention knob of the MD cartridge is set to the close position. Otherwise, "DISC PROTECTED" will appear when you try to record a signal to the MD.
- Be sure that the MD has enough space for recording. If not, carry out ALL ERASE or ERASE function to erase all the tracks or desired tracks in the MD. (See page 18-19.) You can check the recordable remaining time of the MD in Stop mode or during recording by pressing the DISPLAY/CHARA button.

(See "Checking the Remaining Time of the MD" mentioned on page 16.)

Indication of the MD Indicator for Recording

The MD indicator on the front panel of the Unit blinks as follow.

- Record-pause mode: Blinks rapidly.
- During recording: Blinks slowly.
- MD inserted or played: Stays lit.

Standard Recording

You can record any sound source to an MD as follows.

- 1. Insert a MD with its label side up.**
The MD indicator lights up.
- 2. Prepare one of the sources.**
CD: Use the "CD Synchro Recording" mentioned below.
Tuner: Tune in to a station.
AUX1 (LINE IN (AUX1)): Press the TAPE/AUX button on the Unit or the Remote Control until "AUX 1 ANALOG IN" appears on the display.
AUX2 (OPTICAL DIGITAL IN (AUX2)): Press the TAPE/AUX button on the Unit or the Remote Control until "AUX 2 DIGITAL IN" appears on the display.
- 3. Press the REC PAUSE button on the Unit or the ●/II button on the Remote Control.**
The MD indicator starts blinking and the track number in the music calendar is increased by 1.
- 4. Play the record source selected in step 2.**
- 5. Press the MD ►II button to start recording.**
The MD indicator blinks slowly and the selected source is recorded on the MD.
- 6. Press the ■ button to stop recording.**
The MD indicator stays lit and "UTOCwriting" appears on the display, indicating that the recording is successfully completed. Then, the MD stops.

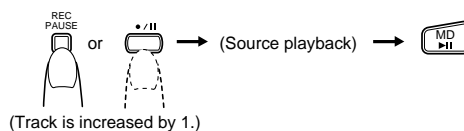

- If the MD becomes full before pressing the ■ button, the recording will be terminated after indicating "UTOCwriting".

Checking the Remaining Time of the MD

You can see the recordable remaining time of the MD in Stop or Recording mode.

Press the **DISPLAY/CHARA** button on the Remote Control, the remaining time appears on the display.

Track marking

- Whenever playback advances from one track to another during digital recording, the track number at the MD side is automatically incremented by 1.
- Whenever no sound at the playback side continues for 3 or more seconds during analog recording, the track number at the MD side is automatically incremented by 1.
- The track number at the MD side is automatically incremented by 1 by pressing the SET button on the remote control at the desirable location during analog recording. (tuner or the equipment connected to the AUX-1.).

CD Synchro Recording

Everything on the CD goes onto the MD in the order it is on the CD, or according to the order you have set in the program. (See page 12 for programming the CD tracks.)

1. Insert an MD with its label side up.

2. Insert a CD. (See page 11.)

3. Press the **CD ►||** button and then press the ■ button to stop the CD.

4. Press the **CD SYNCHRO REC** button on the Unit.

Digital recording from the CD to the MD starts.

- The track number for the MD increases synchronous with the track on the CD.
- After the CD Player has played the entire CD or all the programmed tracks, "UTOCwriting" appears on the display, indicating that the recording is successfully completed. Then, the MD and the CD stops.
- When the MD becomes full before the CD Player finishes playback, the MD stops after indicating "UTOCwriting".

One Track Recording

1. Insert an MD with its label side up.

2. Play the track on the CD you wish to record.

3. Press the **CD SYNCHRO REC** button on the Unit.

The CD Player returns to the beginning of that track and the track is recorded on the MD. After recording, the CD Player and MD Player automatically stop.

Using the MD Player (Editing)

In addition to its recording and play functions, the MD Player comes with editing functions. You can divide, join, move, or erase the recorded tracks in the MD as required. Also, you can give a disc title to the MD and track titles to the tracks in the MD.

Dividing tracks (DIVIDE function)

This involves adding a track mark (see Note) at some point during the track which is to be made into the start of an additional track so that the original track is divided into two tracks.

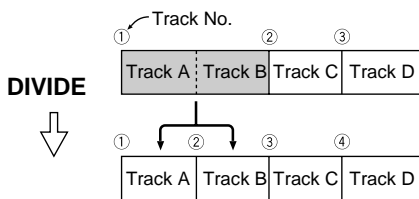

Moving tracks (MOVE function)

Tracks can be moved around so that they are in the desired sequence.

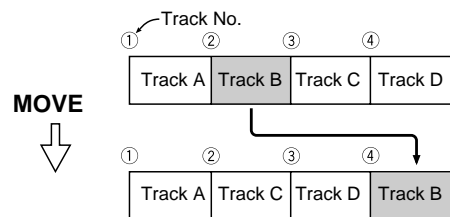

Joining tracks (JOIN function)

This involves erasing a track mark and turning two adjoining tracks into one track.

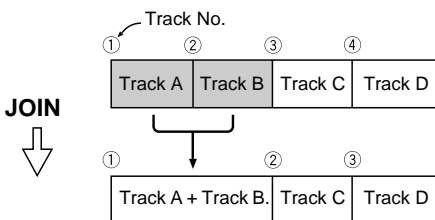

Erasing tracks (ERASE function)

This enables unnecessary tracks, Narration, etc. to be erased speedily. The erased parts do not remain as silences but are closed up by the subsequent tracks.

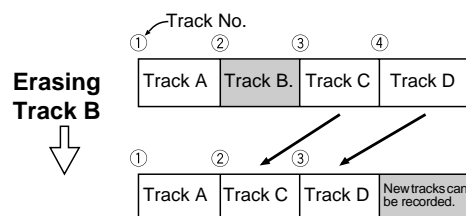

Erasing all the tracks (ALL ERASE function)

All the tracks can be erased at once without recording fresh material over them.

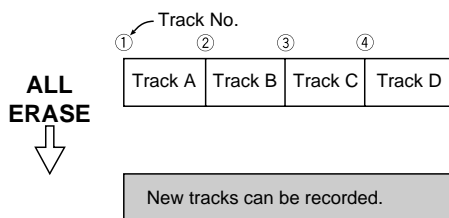

Giving titles to discs and tracks (TITLE function)

A title consisting of up to 32 characters can be given to a disc and a track. The title given appears in the display window.

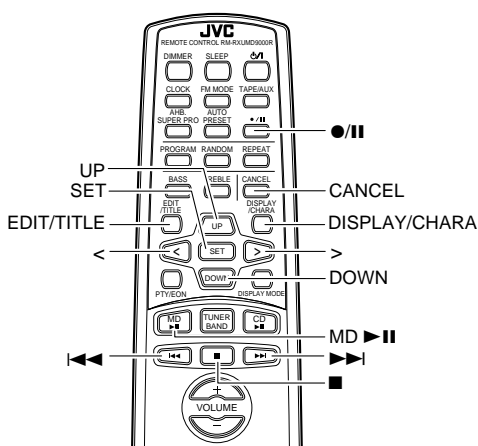

Note: Track marks

These marks are provided to locate the start of each track. Whatever lies between one track mark and the next is considered to a track. and the numbers of the tracks (called "track numbers") are displayed in the sequence in which they are to be played.

Track number, Playing time, Preset number

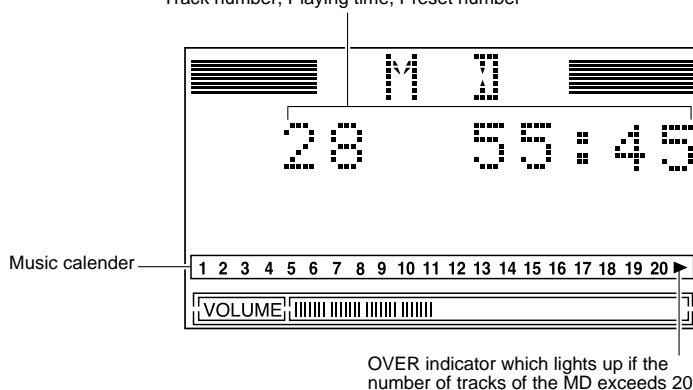

Dividing Tracks (DIVIDE Function)

Use the Remote Control to carry out this function.

1. Insert an MD to be edited with its label side up.

2. Press the MD ►|| button and then ■ button to set the function to MD.

The track numbers and total playback time are displayed.

3. Press the EDIT/TITLE button until "DIVIDE ?" is displayed.

The "EDIT" indicator appears on the display.
 DIVIDE → JOIN → MOVE → ERASE → ALL ERASE → DISC TITLE → TITLE → (Back to the beginning)

4. Press the SET button.

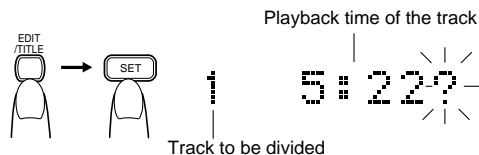

5. Select the track number to be divided.

The selected track is automatically played.
 To select the track number, press the UP, DOWN, >, or < button.

- UP button: Increases the track number by 1.
- DOWN button: Decreases the track number by 1.
- > button: Rapidly increases the track number.
- < button: Rapidly decreases the track number.

6. Press the SET button at the point where the track is to be divided.



- The selected track is divided into two tracks and the track number in the music calendar will increase by 1.
- The recording lasting for 4 seconds starting where the track was divided is repeatedly played for your reference. Movement is possible within the POSITION-128 to 128 range (about 8 seconds before or after the position). The recording lasting for 4 seconds starting from the position to which the dividing point has been moved is repeatedly played.

7. Press the SET button.

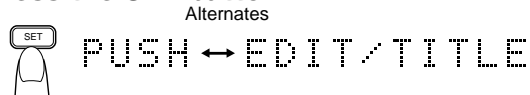

8. Press the EDIT/TITLE button.

The "EDIT" indicator disappears on the display.

9. Press the MD ▲ button to complete editing.

The MD is ejected after "UTOCwriting" is displayed.

- You can also complete editing operation by pressing the ◀/|| button to turn off the power.

To cancel the operation, press the CANCEL button in step 4, 5, or 7 until the display returns to the original display before editing the track.

Note: While "UTOCwriting" is displayed, do not disconnect the power cord or subject the Unit to the vibration to avoid incorrect recording.

Joining Tracks (JOIN Function)

■ Use the Remote Control to carry out this function.

1. Insert an MD to be edited with its label side up.

2. Press the MD ►|| button and then ■ button to set the function to MD.

The track numbers and total playback time are displayed.

3. Press the EDIT/TITLE button until "JOIN ?" is displayed.

The "EDIT" indicator appears on the display.

DIVIDE→JOIN→MOVE→ERASE→ALL ERASE→DISC
TITLE→TITLE→(Back to the beginning)

4. Press the SET button.

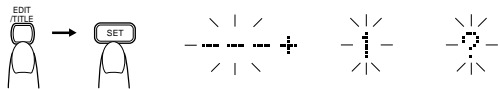

5. Select the track number to be joined.

To select the track number, press the UP, DOWN, >, or < button. (For details, see step 5 in "Dividing Tracks (DIVIDE Function)".)

Example: Track number 2.

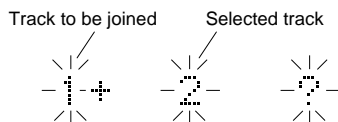

6. Press the SET button.

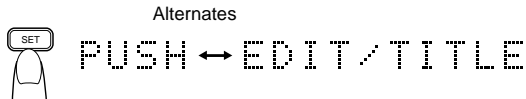

7. Press the EDIT/TITLE button.

The selected track and the previous track are joined and the track numbers in the music calendar will decrease by 1.

- Then the "EDIT" indicator disappears on the display.

8. Press the MD▲ button to complete editing.

The MD is ejected after "UTOCwriting" is displayed.

- You can also complete editing operation by pressing the button to turn off the power.

To cancel the operation, press the CANCEL button in step 4, 5, or 6 until the display returns to the original display before editing the track.

Note: While "UTOCwriting" is displayed, do not disconnect the power cord or subject the Unit to the vibration to avoid incorrect recording.

Moving Tracks (MOVE Function)

■ Use the Remote Control to carry out this function.

1. Insert an MD to be edited with its label side up.

2. Press the MD ►|| button and then ■ button to set the function to MD.

The track numbers and total playback time are displayed.

3. Press the EDIT/TITLE button until "MOVE ?" is displayed.

The "EDIT" indicator appears on the display.

DIVIDE→JOIN→MOVE→ERASE→ALL ERASE→DISC
TITLE→TITLE→(Back to the beginning)

4. Press the SET button.

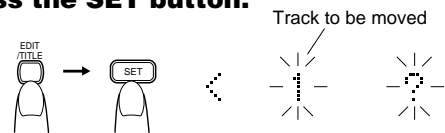

5. Select the track number to be moved.

To select the track number, press the UP, DOWN, >, or < button. (For details, see step 5 in "Dividing Tracks (DIVIDE Function)".)

Example: Track number 12.



6. Press the SET button.



7. Select the destination to which the track is to be moved.

To select the track number, press the UP, DOWN, >, or < button.

In this example, the 12th track will move to the 14th track. (Since, the 12th track is lost, the upper tracks than the 12th one will be shifted toward the younger tracks.)

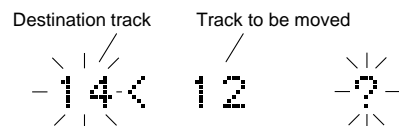

8. Press the SET button.

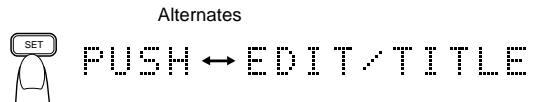

9. Press the EDIT/TITLE button.

The "EDIT" indicator disappears on the display.

10. Press the MD▲ button to complete editing.

The MD is ejected after "UTOCwriting" is displayed.

- You can also complete editing operation by pressing the button to turn off the power.

To cancel the operation, press the CANCEL button in step 4 through 8 until the display returns to the original display before editing the track.

Note: While "UTOCwriting" is displayed, do not disconnect the power cord or subject the Unit to the vibration to avoid incorrect recording.

Erasing Tracks (ERASE Function)

■ Use the Remote Control to carry out this function.

1. Insert an MD to be edited with its label side up.

2. Press the MD ►|| button and then ■ button to set the function to MD.

The track numbers and total playback time are displayed.

3. Press the EDIT/TITLE button until "ERASE ?" is displayed.

The "EDIT" indicator appears on the display.
 DIVIDE→JOIN→MOVE→ERASE →ALL ERASE→DISC
 TITLE→TITLE→(Back to the beginning)

4. Press the SET button.

Track to be erased



5. Select the track number to be erased.

To select the track number, press the UP, DOWN, >, or < button. (For details, see step 5 in "Dividing Tracks (DIVIDE Function)".)

6. Press the SET button.

Alternates

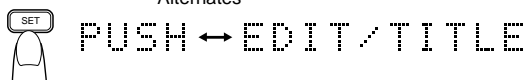

7. Press the EDIT/TITLE button.

The selected track is erased and the track numbers in the music calender decreases by 1.
 Then the "EDIT" indicator disappears on the display.

8. Press the MD ▲ button to complete editing.

The MD is ejected after "UTOCwriting" is displayed.
 • You can also complete editing operation by pressing the ⏻ button to turn off the power.

To cancel the operation, press the CANCEL button in step 4, 5, or 6 until the display returns to the original display before editing the track.

Note: While "UTOCwriting" is displayed, do not disconnect the power cord or subject the Unit to the vibration to avoid incorrect recording.

Erasing all the Tracks (ALL ERASE Function)

■ Use the Remote Control to carry out this function.

1. Insert an MD to be edited with its label side up.

2. Press the MD ►|| button and then ■ button to set the function to MD.

The track numbers and total playback time are displayed.

3. Press the EDIT/TITLE button until "ALL ERASE ?" is displayed.

The "EDIT" indicator appears on the display.
 DIVIDE→JOIN→MOVE→ERASE→ALL ERASE→DISC
 TITLE→TITLE→(Back to the beginning)

4. Press the SET button.

Alternates

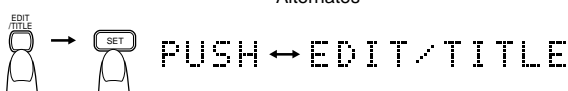

5. Press the EDIT/TITLE button.

All the tracks in the MD are erased and "BLANK DISC" is kept displayed.

The "EDIT" indicator disappears on the display.

To cancel the all erasing, press the CANCEL button in step 4. To remove the MD, press the MD▲ button.

Note: While "UTOCwriting" is displayed, do not disconnect the power cord or subject the Unit to the vibration to avoid incorrect recording.

Giving Titles to MD (DISC TITLE/TITLE Function)

You can give a disc title to the MD and a track title to the tracks in the MD. Any title name can be given up to 32 characters using the provided character sets.

The disc title you have given will be displayed in the following cases.

- When you insert the MD while the function is set to MD.
- When you press the MD►|| button and then ■ button to set the function to MD.

Once you have given the title to the tracks, the track title will be displayed before playing the track.

- Since the procedure to give title is the same as for the disc title and track title except for step 4, both functions are explained together here.
- Use the Remote Control to carry out these functions.

1. Insert an MD to be edited with its label side up.

2. Press the MD ►|| button and then ■ button to set the function to MD.

The total track numbers and total playback time are displayed.

3. Press the EDIT/TITLE button until "DISC TITLE ?/TITLE ? (for track title)" is displayed.

The "EDIT" indicator appears on the display.
 DIVIDE→JOIN→MOVE→ERASE→ALL ERASE→DISC
 TITLE→TITLE→(Back to the beginning)

4. Press the SET button.

- For DISC TITLE:

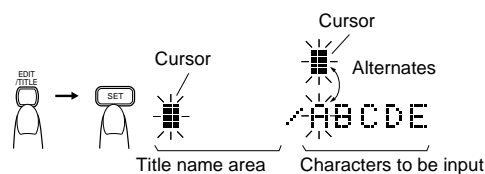

- For TITLE (Track Title):

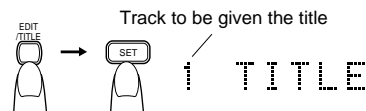

- ① Select the track number to be given the title using the UP, DOWN, >, or < button. (For details, see step 5 in "Dividing Tracks (DIVIDE Function)".)
- ② Press the SET button.

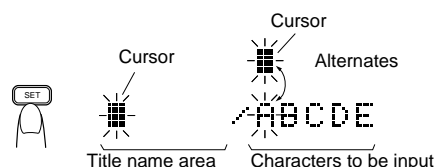

5. Input a preferred title (up to 32 characters).

Use the following buttons to input a title.

[Title editing buttons and their functions] (see below)

Button	Function
DISPLAY /CHARA	Changes the type of characters to be input as follows. Upper-case letters and symbols ↓ Lower-case letters and symbols ↓ Numbers
>	Moves the cursor for the character to be input to the right.
<	Moves the cursor for the character to be input to the left.
UP	Selects the characters in the upper row in the character set. e.g. FGHIJ → ABCDE
DOWN	Selects the characters in the lower row in the character set. e.g. ABCDE → FGHIJ
▶▶	Moves the cursor for the title name to the right.
◀◀	Moves the cursor for the title name to the left.

Example: When input the title "N(space)1"

- Display the letter N to be input.
 - Press the > button until the letter N is displayed.

OR

 - Press the DOWN button until "KLMNO" is displayed.
- Select "N" (put the cursor to the letter N using the > or < button).
- Press the SET button.

[Character Layout Table]

You can write album or song names to a disc, using the following characters:

Uppercase letters

A	B	C	D	E
F	G	H	I	J
K	L	M	N	O
P	Q	R	S	T
U	V	W	X	Y
Z				
(space)	!	"	#	\$
%	&	'	()
*	+	,	-	.
/	:	;	<	=
>	?	@	_	`

Lowercase letters

a	b	c	d	e
f	g	h	i	j
k	l	m	n	o
p	q	r	s	t
u	v	w	x	y
z				
(space)	!	"	#	\$
%	&	'	()
*	+	,	-	.
/	:	;	<	=
>	?	@	_	`

Numbers

0	1	2	3	4
5	6	7	8	9

The letter N is now displayed in the title area.



- Select "(space)" and press the SET button.
- Press the DISPLAY/CHARA button until the numbers are displayed.
- Select "1" and press the SET button.
The title name "N(space)1" will be displayed.

Editing the Title Name:

- If the wrong character has been input, clear it using the CANCEL button.
- To clear a particular character which has been input, use the ▶▶ or ◀◀ button to align the cursor with the character, and press the CANCEL button. Then, select the correct character and press the SET button.

6. Press the EDIT/TITLE button.



Alternates

PUSH ↔ EDIT/TITLE

7. Press the EDIT/TITLE button again.

The "EDIT" indicator disappears on the display.

8. Press the MD▲ button to complete editing.

The MD is ejected after "UTOCwriting" is displayed.

- You can also complete editing operation by pressing the ⏻ button to turn off the power.

To cancel the operation, press the CANCEL button in step 6.

Note: While "UTOCwriting" is displayed, do not disconnect the power cord or subject the Unit to the vibration to avoid incorrect recording.

Using External Equipments

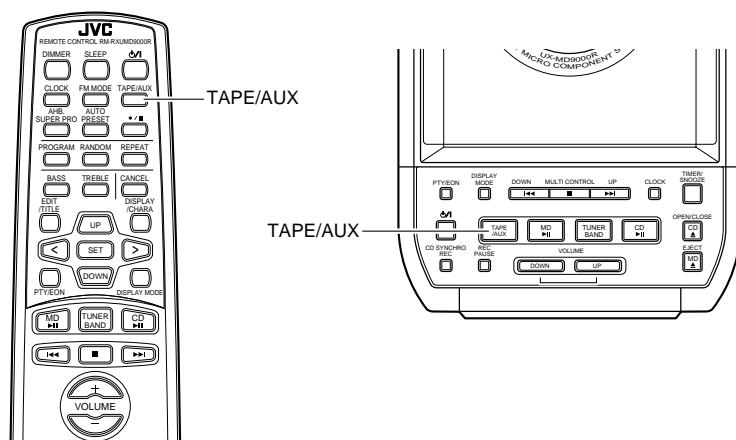

Listening to External Equipment

You can listen to external equipment.

■ First make sure that the external equipment is properly connected to the System. (See page 4).

1. Set the **VOLUME** control to the minimum position.

2. Press the **TAPE/AUX** button.

The display changes with each press of the button, as shown below.

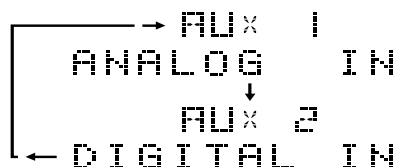

When the "AUX 1 ANALOG IN" is selected:

You can use the external equipment connected to the LINE IN (AUX1) terminals of the System, such as cassette deck, turntable, etc.

- To listen to the external equipment, start playing the external equipment.

When the "AUX 2 DIGITAL IN" is selected:

You can use the external equipment connected to the OPTICAL DIGITAL IN (AUX2) terminal of the System, such as CD player, etc.

- To listen to the external equipment, start playing the external equipment.

3. Adjust the **VOLUME** control to the desired listening level.

4. Apply sound effects, if you wish.

- Press the AHB Super PRO button to reinforce the bass sound.
- Press the BASS/TREBLE button to control the tone. (See "Tone Control" on page 7.)

Note: For operation of the external equipment, refer to its Instructions.

Recording to External Equipment

You can record the System's source to external equipment which is connected to the LINE OUT terminals of the System, such as cassette deck, etc.

■ First make sure that the external equipment is properly connected to the System. (See page 4).

1. Play the System's CD Player, MD Player, or tune into a station.

■ The recording level is not affected by the VOLUME level set by the System. Also it is not affected by the sound effects.

Note: For operation of the external equipment, refer to its Instructions.

Using the Timers

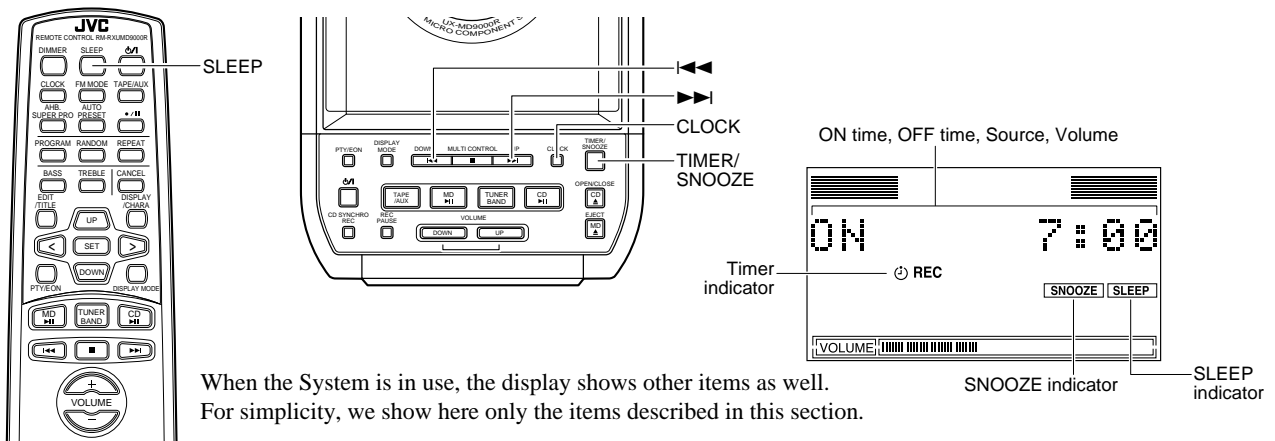

The timers let you control listening and recording functions automatically.

Setting the Clock

- When you plug the AC power cord into the wall outlet, the time indication blinks on the display. You can set the clock whether the System is on or off.

Note:

- The clock must be correctly set for the timers to work.
- The procedure must be completed within two minutes. Otherwise, the setting is cleared and must be repeated from the beginning.

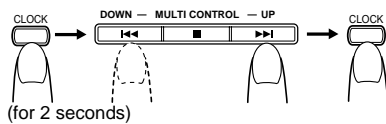

1. Press the **CLOCK** button on the Unit for more than two seconds.

The time indication rapidly blinks on the display.

2. Press the **▶▶** or **◀◀** button on the Unit to set the time.

Pressing the **▶▶** button moves the time forwards and pressing the **◀◀** button moves it backwards. Hold down the button to move the time in 10-minute intervals.

3. Press the **CLOCK** button.

The selected time is set and the seconds start counting from 0.

CAUTION: If there is a power failure, the clock loses its setting after about 20 minutes. "0:00" blinks on the display and the clock must be reset.

Setting the Daily Timer

Once you have set the Daily Timer, the timer will be activated at the same time every day. It can be cancelled and re-activate whenever you wish.

The Timer indicator on the display shows when the Daily Timer you have set is in effect.

Note: Perform each setting within 30 seconds. Otherwise, setting is cleared and the procedure must be repeated from the beginning.

1. Press the **⏻** button to turn on the System.

2. Setting the ON time (Example: 12:15).

- Press the **TIMER/SNOOZE** button on the Unit. The Timer indicator lights up and the current ON time blinks on the display.



- Press the **▶▶** or **◀◀** button on the Unit to set the time you want the Unit to come on. Pressing the **▶▶** button moves the time forwards and pressing the **◀◀** button moves it backwards. Hold down the button to move the time in 10-minute intervals.

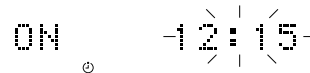

3. Setting the OFF time (Example: 13:15).

- Press the **TIMER/SNOOZE** button on the Unit. The current OFF time blinks on the display.



- Press the **▶▶** or **◀◀** button on the Unit to set the time you want the Unit to be turned off. Pressing the **▶▶** button moves the time forwards and pressing the **◀◀** button moves it backwards. Hold down the button to move the time in 10-minute intervals.



4. Selecting the music source.

- Press the **TIMER/SNOOZE** button on the Unit. The "TUNER" blinks on the display.
- Press the **▶▶** or **◀◀** button to select the music source you want to listen to. The display changes as shown below.
TUNER ↔ TUNER REC ↔ CD ↔ MD ↔ (back to the beginning)

- When you select the "TUNER REC", the "REC" indicator appears on the display.

5. Setting the volume level.

- Press the **TIMER/SNOOZE** button on the Unit. The current volume setting blinks on the display.
- Press the **▶▶** or **◀◀** button to select the volume level. -- : The current volume level will be used.
0 to 50: When the timer is turned on, the Volume will be automatically set to the selected level.



6. Press the **TIMER/SNOOZE** button on the Unit.

The timer setting is completed and the display returns to the display before you set the timer. The timer indicator remains lit.

7. Before turning off the System, prepare the music source selected in step 4.

TUNER: Tune in to the desired station.

TUNER REC: Tune in to the desired station and insert an MD for recording the station.

CD: Insert a CD.

MD: Insert an MD.

8. Press the **⏻** button to turn off the System.

To cancel the timer, press the **TIMER/SNOOZE** button. The Timer indicator goes out on the display.

To re-activate the cancelled timer, press the **TIMER/SNOOZE** button to light the Timer indicator. Then, press the **TIMER/SNOOZE** button until the display returns to the original display.

To confirm the timer settings, cancel the timer once by pressing the **TIMER/SNOOZE** button. Then, press the **TIMER/SNOOZE** button repeatedly, to see the current timer settings (ON time, OFF time, source, and volume).

To change the timer setting, repeat the setting procedure from the beginning.

- When the timer turns on, the Timer indicator starts blinking and the volume level gradually increases from 0 (zero) to the preset level, except when you set the volume level to “—” in step 5.

CAUTION: If the System is unplugged, or a power failure occurs, the timer setting will be lost. You will need to reset the clock first, then the timer.

5-Minute Snoozing

When the timer turns on the music source you can, if you wish, activate the 5-minute snoozing function to temporarily stop playback.

Press the **TIMER/SNOOZE** button on the Unit.

The “SNOOZE” indicator lights up on the display and the power is turned off for five minutes for snoozing.

Information on MDs (Minidisks)

This is a new digital audio disc format: it has a diameter of 64 mm and enables up to 74 minutes of playback and recording.

The cartridge

The diameter of the disc itself is 64 mm, smaller than a CD single. The disc sits inside a 68 x 72 mm cartridge, which also being pocket size, makes minidisks extremely handy for carrying and storage. Since the disc is protected by the cartridge, dust and dirt cannot easily get into it. And thanks to a shutter which is closed at all times except during use, there is no need to worry about scratches or finger marks, making the handling of minidisks very simple.

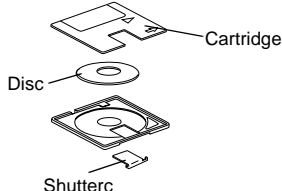

Two types of minidisc

There are two types of minidisc, “recordable MDs” and “playback-only MDs.” The playback method for each is the same: a laser irradiates the disc and the signal is read from the beam which comes back. However, the recording method for each type is different.

Setting the SLEEP Timer

Use the Sleep Timer to turn the System off after a certain number of minutes when it is playing. By setting the Sleep Timer, you can fall asleep to music and know that your System will turn off by itself rather than play all night.

- You can only set the Sleep Timer when the System is on and a source is playing.

1. Play a CD, MD, or tune in to the desired station.

2. Press the **SLEEP** button on the Remote Control.

The “SLEEP” indicator lights up.

3. Set the length of time you want the source to play before shutting off.

- Each time you press the **SLEEP** button, it changes the number of minutes shown on the display in this sequence:
→ 30 → 60 → 90 → 120 → Cancelled → (back to the beginning)

After setting the number of minutes for the Sleep Timer, the display will stop blinking and return to the display as before setting the Sleep Timer. (The display is dimmed.)

The System is now set to turn off after the number of minutes you set.

To Confirm the Sleep Time

When the **SLEEP** button is pressed, the remaining sleep time is displayed. Wait until the display returns to the original display.

To Cancel the SLEEP Timer Setting

Press the **SLEEP** button until the “SLEEP” indicator goes out on the display.

Turning off the System also cancels the **SLEEP** Timer.

- If you are setting the Daily Timer, the System will be turned on at the set time to wake you up.

Playback-only MD

This is the type used for commercially-available pre-recorded MDs, on which recording cannot be done. Like a CD, data is recorded based on the presence or absence of small indentations called pits. A disc recorded with this format is called an “optical disc.”

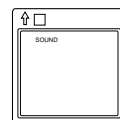

Recordable MDs

These are the so-called “blank” MDs you can use to make your own recordings. Data is recorded by magnetism, which is easily processed, so that recording can be done again and again. By using a laser to heat the disc, the magnetism is erased and the magnetic head records the new data. Discs with this type of recording method are called magneto-optical (MO) discs.

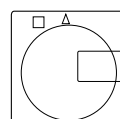

ATRAC (Adaptive Transform Acoustic Coding)

Within recordings, there are sounds which cannot be readily heard. For example, as the volume decreases, high-pitched sounds and low-pitched sounds become difficult to hear. Also, if a quiet sound comes at the same time as or just after a loud sound, it will not be heard. With minidiscs, data is compressed using a technology called ATRAC (Adaptive Transform Acoustic Coding) which selectively chooses sounds based on human sense of hearing characteristics. With this technology, the recorded data is about one-fifth the volume of the original data, allowing it to fit on a compact minidisc.

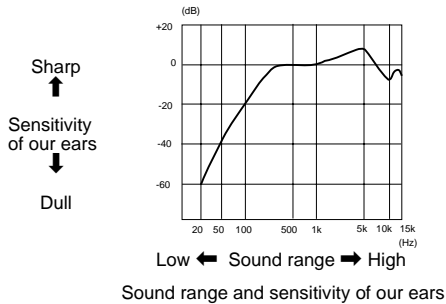

Sound skip guard memory

With the minidisc, the data of the track being played can be temporarily stored up using a function called "sound skip guard memory". Even when data cannot be collected properly from the disc due to shaking or vibrations, information is stored in the "sound skip guard memory", so that there is no break in the sound which is actually delivered.

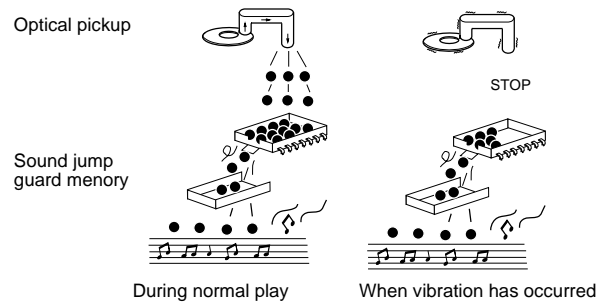

UTOC (User Table Of Contents)

In a minidisc, apart from the recorded tracks, there is the "UTOC". In this area, information such as the position where each track is recorded, the track divisions, and track order are listed. When music search is done, the UTOC is consulted, and the tracks are quickly found and played back. When editing is done, only the UTOC is changed, so there is no need to re-record the tracks.

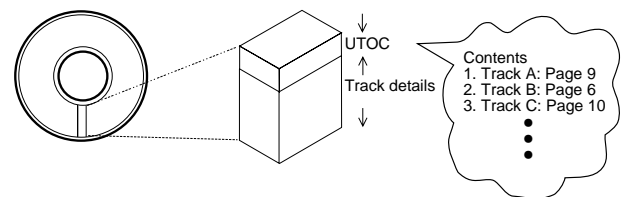

MD (Minidisc) Error Messages

Error message	Meaning	Action
BLANK DISC	A disc has been inserted with nothing recorded on it.	Except when making a new recording, replace the disc with one which has been recorded on.
CANNOT JOIN	You have tried to join tracks which cannot be joined.	This is a limitation of the minidisc system. See "Minidiscs limitations" on page 25.
DISC ERROR	There is a problem (damage) with the disc.	Replace the disc..
DISC FULL	There is not enough space left on the disc. There are over 254 tracks.	Replace the disc with another recordable MD.
DISC PROTECTED	The disc is in accidental erasure protection mode.	Slide the accidental erasure protection tab. (So that the hole is covered.)
EMERGENCY STOP	A malfunction occurred during recording.	Stop the disc by pressing the ■ button and redo the operation.
NO DISC	There is no disc in the unit.	Insert a disc into the unit.
NON AUDIO CANNOT COPY	You have tried to digitally dub a CD-ROM	Stop recording.
PLAYBACK MD	You have tried to record or edit on a playback-only disc.	Replace the disc with a recordable MD.
TRACK PROTECTED	The track is protected.	This unit cannot undo track protection. Undo the protection using the appliance that created it.
SCMS CANNOT COPY	You have tried to make a copy of a copy by digital dubbing.	Dub using analogue input (LINE IN).
DIGITAL IN UNLOCK	The digital cable is disconnected.	Connect the digital cable securely.

Minidisc limitations

The minidisc records information in an original format that differs from that of conventional cassette tapes or DATs. Since there are some limitations with this recording format, the following types of conditions may arise. These conditions are not malfunctions.

Condition	Cause
"DISC FULL" is displayed, even though the possible recording time is not used up.	With the minidisc, there is a maximum number of tracks which can be recorded, regardless of time. More than 254 tracks cannot be recorded on a disc. When parts of the disc are erased and re-recorded, blank spots are created on the disc. When recording to such a disc, one track of data is divided and recorded in the blank areas. During recording, when these divided parts become numerous, the "DISC FULL" message may be displayed. When a part of 8 seconds or less is created by division, that track cannot be joined by the JOIN function, and even if it is erased, the remaining usable time on the disc does not increase. Tracks divided into small pieces may skip when fast forward or fast rewind is done.
"DISC FULL" is displayed, even though the number of tracks and recording time are not at the limit.	
The JOIN function sometimes doesn't work	
The remaining usable time on the disc doesn't increase even when tracks are erased.	
The sound skip during fast forward or fast rewind.	
The amount of recorded time on the disc added to the amount of remaining time falls short of the disc's total possible recording time.	Minidiscs must have at least 2 seconds of continuous space in order to record. For this reason, the actual recording time of discs with a lot of short blank areas becomes shorter.

Rules of Digital Dubbing

The following rules regarding copyright exist for dubbing to MDs from CDs or DATs through digital terminals.

SCMS (Serial Copy Management System)

Minidiscs can record clear sound with low loss of quality from CDs or DATs through each component's digital input/output terminal. However, minidiscs are set up so that a disc recorded in this way cannot be recorded onto another minidisc through digital input/output terminals. In other words, you can not make a copy of a copy. This rule is called SCMS (Serial Copy Management System).

The recorder is designed in compliance with this rule. If you try to make a copy of a copy the error message "SCMS CANNOT COPY" is displayed, and dubbing can not be done.

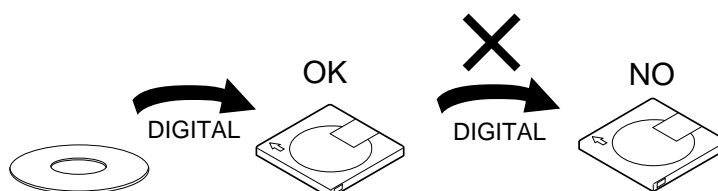

It may be unlawful to record or play back copyrighted material without the consent of the copyright owner.

Care And Maintenance

Handle your CDs and MDs carefully, and they will last a long time.

Compact Discs

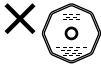
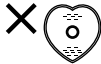

- Only CDs bearing this mark can be used with this System. However, continued use of irregular shape CDs (heart-shape, octagonal, etc.) can damage the System.



- Remove the CD from its case by holding it at the edges while pressing the case's center hole lightly.
- Do not touch the shiny surface of the CD, or bend the CD.

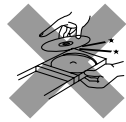

- Put the CD back in its case after use to prevent warping.
- Be careful not to scratch the surface of the CD when placing it back in the case.
- Avoid exposure to direct sunlight, temperature extremes, and moisture.



- A dirty CD may not play correctly. If a CD does become dirty, wipe it with a soft cloth in a straight line from center to edge.

CAUTION: Do not use any solvent (for example, conventional record cleaner, spray thinner, benzene, etc.) to clean a CD.

MDs (Minidiscs)

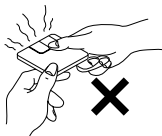

Do not open the shutter. Since the shutter is locked to prevent it from opening, forcing it to open will break the disc.

Moisture Condensation



Moisture may condense on the lens inside the System in the following cases:

- After turning on heating in the room.
- In a damp room.
- If the System is brought directly from a cold to a warm place.

Should this occur, the System may malfunction. In this case, leave the System turned on for a few hours until the moisture evaporates, unplug the AC power cord, and then plug it in again.

General Notes

In general, you will have the best performance by keeping your CDs, MDs, and the mechanism clean.

- Store CDs and MDs in their cases, and keep them in cabinets or on shelves.
- Keep the system's CD holder closed when not in use.

Cleaning the lens

If the lens in the CD pickup is dirty, dropout, etc., could degrade sound.

Open the CD holder and clean the lens as shown.

- Use a blower (available from a camera store) to blow dust off the lens.

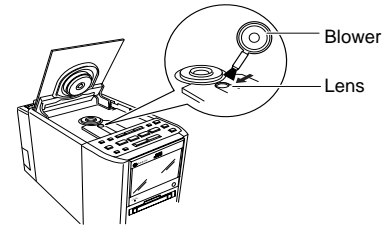

- If there are fingerprints, etc. on the lens, gently wipe clean with a cotton swab.

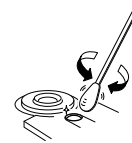

The cabinet of the speaker is coated with high-grade polished paint. When dirt such as a fingerprint, dust, etc. is stuck to the cabinet, first, dust the coating surface with the attached polishing cloth. Next, lightly wipe off the dirt.

If the polishing cloth is dirty, wash it using a synthetic detergent.

Troubleshooting

- If you are having a problem with your System, check this list for a possible solution before calling for service.
- If you cannot solve the problem from the hints given here, or the System has been physically damaged, call a qualified person, such as your dealer, for service.

Symptom	Possible Cause	Action
No sound is heard.	<ul style="list-style-type: none"> • Connections are incorrect, or loose. • Headphones are connected. 	<ul style="list-style-type: none"> • Check all connections and make corrections. (See pages 4- 5.) • Disconnect the headphones.
Poor radio reception	<ul style="list-style-type: none"> • The antenna is disconnected. • The AM Loop Antenna is too close to the System. • The FM Wire Antenna is not properly extended and positioned. 	<ul style="list-style-type: none"> • Reconnect the antenna securely. • Change the position and direction of the AM Loop Antenna. • Extend FM Wire Antenna to the best reception position.
The CD skips.	The CD is dirty or scratched.	Clean or replace the CD.
The CD does not play.	The CD is upside down.	Put the CD in with the label side up.
The MD cannot be inserted.	An MD has already been inserted.	Press the MD▲ button to eject the inserted MD and insert a new MD.
Recording cannot be made on MD.	The accidental erasure prevention knob of the MD is set to the open position.	Set it to the close position.
Timer fails to start.	Present time is not correct.	Set the time correctly.
Unable to operate the Remote Control.	<ul style="list-style-type: none"> • The path between the Remote Control and the sensor on the Unit is blocked • The batteries have lost their charge. 	<ul style="list-style-type: none"> • Remove the obstruction. • Replace the batteries.
Operations are disabled.	The built-in microprocessor has malfunctioned due to external electrical interference.	Unplug the System then plug it back in

Specifications

Amplifier

Output Power 30 W (15 W + 15 W) at 4 ohms (Max.)
20 W (10 W + 10 W) at 4 ohms (10% THD)

Input Sensitivity/Impedance (1 kHz)

LINE IN (AUX 1) 500 mV/60 kohms

Optical In -24 dBm - -15 dBm

Output Sensitivity/Impedance (1 kHz)

LINE OUT 500 mV/5 kohms

Subwoofer 0 - 144 mV/30 kohms

Speaker terminals 4 - 16 ohms

Phones 16 ohms - 1 kohms

MD Player

Wow And Flutter Unmeasurable

CD Player

Wow And Flutter Unmeasurable

Tuner

FM Tuner

Tuning Range 87.5 - 108.0 MHz

AM Tuner

Tuning Range (MW) 522 - 1,629 kHz

(LW) 144 - 288 kHz

Speaker Specifications

(each unit) Speakers 8 cm cone

Impedance 4 ohms

Dimensions 120 × 160 × 190 mm (W/H/D)

Mass Approx. 1.3 kg

General

Dimensions 380 × 164 × 301 mm (W/H/D)

Mass Approx. 6.4 kg

Accessories

Power Cord (1)

AM Loop Antenna (1)

Remote Control (1)

Batteries R6P (SUM-3)/AA (15F) (2)

FM Wire Antenna (1)

Speaker Cords (2)

Polishing Cloth (1)

Power Specifications

Power Requirements AC 230 V ~ , 50 Hz

Power Consumption 30 watts (power on mode)

5 watts (in Standby mode)

Design and specifications are subject to change without notice.



Free Manuals Download Website

<http://myh66.com>

<http://usermanuals.us>

<http://www.somanuals.com>

<http://www.4manuals.cc>

<http://www.manual-lib.com>

<http://www.404manual.com>

<http://www.luxmanual.com>

<http://aubethermostatmanual.com>

Golf course search by state

<http://golfingnear.com>

Email search by domain

<http://emailbydomain.com>

Auto manuals search

<http://auto.somanuals.com>

TV manuals search

<http://tv.somanuals.com>