

JVC

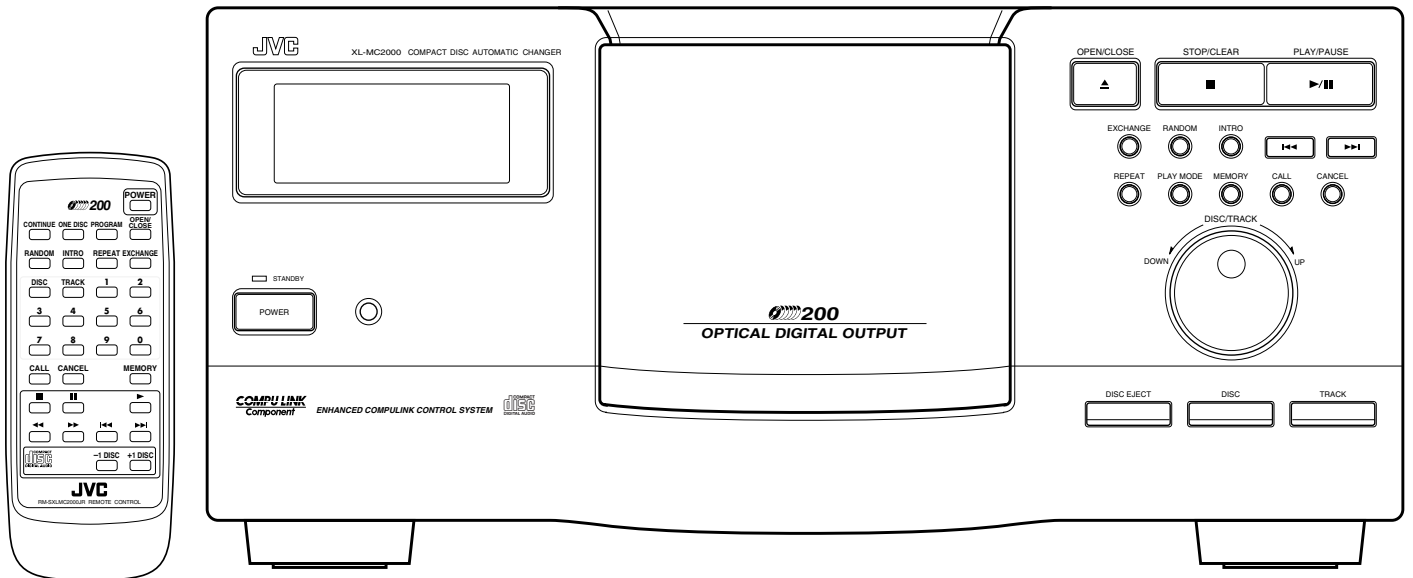

COMPACT DISC AUTOMATIC CHANGER

XL-MC2000BK



COMPU LINK
Component

compact disc
DIGITAL AUDIO

INSTRUCTIONS

For Customer Use:

Enter below the Model No. and Serial No. which are located on the rear, bottom or side of the cabinet. Retain this information for future reference.

Model No. _____

Serial No. _____

LVT0359-001B

[J]

WARNING AND CAUTIONS

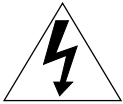

The lightning flash with arrowhead symbol, within an equilateral triangle is intended to alert the user to the presence of uninsulated "dangerous voltage" within the product's enclosure that may be of sufficient magnitude to constitute a risk of electric shock to persons.



The exclamation point within an equilateral triangle is intended to alert the user to the presence of important operating and maintenance (servicing) instructions in the literature accompanying the appliance.

For U.S.A.

This equipment has been tested and found to comply with the limits for a Class B digital device, pursuant to part 15 of the FCC Rules. These limits are designed to provide reasonable protection against harmful interference in a residential installation.

This equipment generates, uses and can radiate radio frequency energy and, if not installed and used in accordance with the instructions, may cause harmful interference to radio communications. However, there is no guarantee that interference will not occur in a particular installation. If this equipment does cause harmful interference to radio or television reception, which can be determined by turning the equipment off and on, the user is encouraged to try to correct the interference by one or more of the following measures:

- Reorient or relocate the receiving antenna.
- Increase the separation between the equipment and receiver.
- Connect the equipment into an outlet on a circuit different from that to which the receiver is connected.
- Consult the dealer or an experienced radio/TV technician for help.

WARNING: TO REDUCE THE RISK OF FIRE OR ELECTRIC SHOCK, DO NOT EXPOSE THIS APPLIANCE TO RAIN OR MOISTURE.

Caution — POWER switch!

Disconnect the mains plug to shut the power off completely. The POWER switch in any position does not disconnect the mains line. The power can be remote controlled.

IMPORTANT FOR LASER PRODUCTS

1. CLASS 1 LASER PRODUCT
2. **DANGER:** Invisible laser radiation when open and interlock failed or defeated. Avoid direct exposure to beam.
3. **CAUTION:** Do not open the top cover. There are no user serviceable parts inside the unit; leave all servicing to qualified service personnel.

CAUTION

To reduce the risk of electrical shocks, fire, etc.:

1. Do not remove screws, covers or cabinet.
2. Do not expose this appliance to rain or moisture.

INTRODUCTION

Thank you very much for purchasing the JVC product. We sincerely hope it proves its quality and performance to your full satisfaction. Please read the instructions contained in this manual in order to get the most of the product's capability and performance. If there are any questions concerning the product, please consult your JVC dealer .

Feature of XL-MC2000

- This component is designed to store up to 200 compact discs, change and play them automatically in three different playback modes.
- This component features a digital optical output jack for direct digital audio transmission to an MD, CD-R, amplifier or receiver.

CONTENTS

Precautions	2
Installation	2
Compact discs	2
Operation	2
Setting Up	3
Connecting the unit	3
Installing batteries in the remote control	4
Control Panel and Remote Control.....	5
Control panel	5
Display	6
Remote control	6
Basic Operation	7
Turning the power on	7
Loading compact discs	7
Unloading/changing discs	7
Playing discs	8
CONTINUE Mode Playback	9
Basic mode	9
Playing discs in random order	9
Playing a track repeatedly	9
Playing only the beginning of each disc's first track	9
ONE DISC Mode Playback	10
Basic mode	10
Playing the tracks in random order	10
Playing the disc repeatedly	10
Playing a track repeatedly	10
Playing only the beginning of each disc's first track	10
PROGRAM Mode Playback.....	11
Basic mode	11
Playing program steps in random order	11
Playing the program repeatedly	12
Playing a program step repeatedly	12
CompuLink-3 Remote Control System	12
Handling and Taking Care of Discs	13
Handling compact discs	13
Cleaning compact discs	13
Storing compact discs	13
Specifications & Packing List	13
Troubleshooting	14

Installation

- **Select the best location**

Select a level location to install this component, where it is free from extremes of temperature (5 to 35°C, or 41 to 95°F), humidity, dust, or vibration.

If noise interference is caused during AM broadcast reception by a tuner/receiver located nearby, relocate it or this component, or turn off either one.

- **Moving the unit**

Before moving the unit, first remove all the discs. Turn the power off, making sure the standby indicator is lit. Then remove the AC power cord from the AC outlet.

Compact discs

- **Use only compact digital audio discs**

Only the audio compact discs identified by the logo shown on the right can be used with this component.



Operation

- **Keep the disc storage free of obstacles**

Do not put anything other than discs in slots of the disc storage.

- **Turn the power off if a problem occurs**

If an unusual condition arises, turn the power off immediately. If the condition persists whenever the power is turned on, consult your JVC dealer.

- **Do not pull the AC power cord**

Do not pull the cable when unplugging the AC cord from the wall socket or this component — hold and pull the plug body.

- **Set the sound volume carefully**

Be careful in setting the sound volume on your amplifier/receiver when playing a CD, which has almost none of background noise unlike analog records and tapes. Find out the right setting starting with a low level setting. Setting the level too high and starting a CD could damage the speakers.

- **Protect the component against condensation**

Condensation inside the component could disrupt the proper transmission of the disc-reading laser beam, causing noise or malfunction. If condensation ever ensues due to excessive humidity or sudden temperature change, leave the component turned on for a couple of hours to dry up — consult your JVC dealer if this does not correct the condition.

SETTING UP

Connecting the unit

This compact disc changer/player needs to be connected to an amplifier/receiver for audio reproduction.

CAUTION

Do not connect the AC power cord until all other necessary connections have been made.

Analog audio connections

First connect the OUTPUT jacks in the back of this unit with the CD or AUX input jacks of the amplifier/receiver using the accessory audio cord. Be sure to insert the audio cord plugs firmly into the proper jacks matching the output and input channels — RIGHT to RIGHT and LEFT to LEFT.

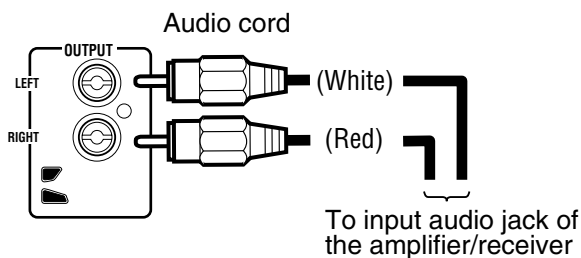

Digital audio connections

If the MD, CD-R, amplifier or receiver you are making connections to has a digital optical input jack, connect the DIGITAL OUT OPTICAL jack in the back of this unit to the CD or AUX digital input jack on the MD, CD-R, amplifier or receiver using a commercially available optical fiber cable.

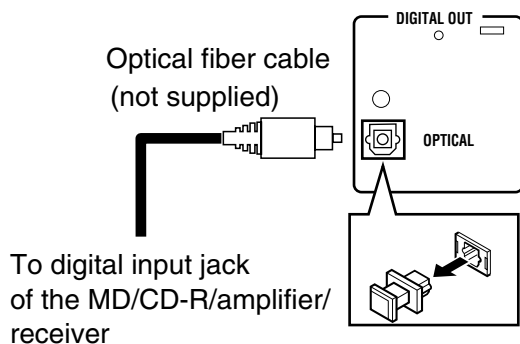

Be sure to pull off the caps before you make any connections, as shown above. Place the caps in a safe place.

System control connections

If you are connecting the unit to a JVC audio component using the CompuLink-3 remote control system, connect the units with the accessory CompuLink cord. Either one of the COMPULINK-3 (SYNCHRO) jacks in the back of this unit can be used.

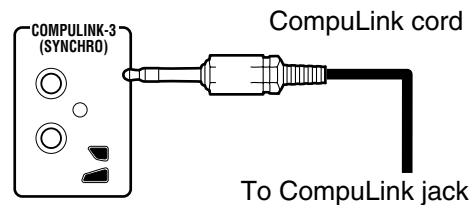

When you use this system, you can remote-control this CD unit from the connected JVC amplifier/receiver. (See Page 12 for more information.)

NOTE: JVC components equipped with two COMPULINK-3 (SYNCHRO) ports can be connected in series; a component with only one jack may only be connected at the end of the series.

Power connection

Connect the accessory AC power cord into the socket in the back of this unit. Then insert the plugs into an AC outlet. (Do not connect the power cord to a switched AC outlet of a component if the CompuLink system is used.)

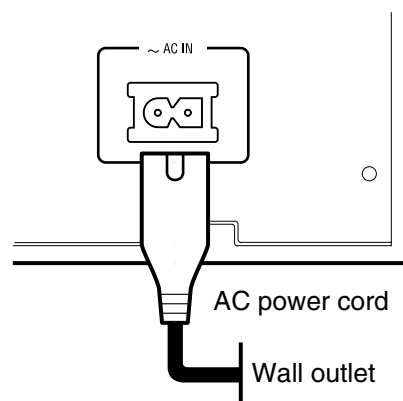

Installing batteries in the remote control

1. Remove the rear cover of the remote control unit.

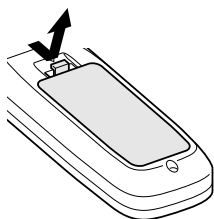

2. Install batteries. Be sure that the batteries are installed with correct polarity, (+) and (-).

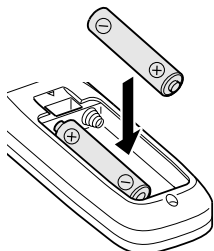

3. Attach the rear cover.

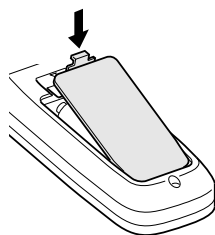

CAUTION

- Install the batteries with their polarities correctly set.
- Remove the batteries if the remote control is not going to be used for an extended period of time.
- Do not expose the remote control to heat, flame, or direct sunlight.

Replacing the batteries

The service life of batteries normally lasts for about one year though it is dependent on the use of the remote control (it is shortened in low temperatures, too). Replace the batteries any time if the controllable range is reduced (max. range: 7 meters or 23 feet and 30 degrees away from the component).

CAUTION

- Be sure to replace them with the correct batteries (1.5V, R6P, AA).
- Do not use new and old batteries in combination.

CONTROL PANEL AND REMOTE CONTROL

Control panel

Alphabetic letters in brackets following button names indicate their counterparts on the remote control.

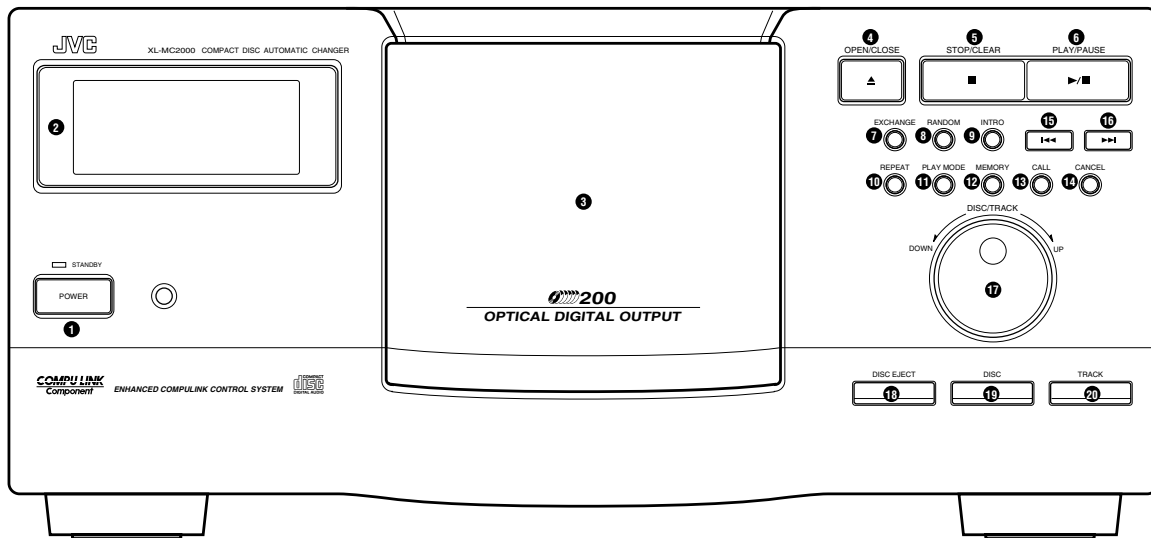

1 POWER button [ⓐ]

Turns the power on and off. The STANDBY indicator above lights when the power is turned off and the unit is in the standby state; it goes out when the power is turned on. (To turn off the unit completely, unplug the power cord from the wall socket.)

2 Display

Shows the current operation status (see next page for more information).

3 Disc storage

Holds up to 200 discs in slots of a carousel, which rotates inside the disc storage.

4 OPEN/CLOSE button [ⓑ]

Opens or closes the disc storage door. The disc in the play position will be retracted into its carousel slot when the door is opened using this button.

5 STOP/CLEAR button [Ⓒ]

Stops playing the disc. Pressing the button in the PROGRAM mode clears all program steps if the unit is stopped.

6 PLAY/PAUSE button [ⓓ , ⓔ]

Retrieves a disc from its carousel slot, places it in the play position, and starts playing the disc; or interrupts the playing temporarily, or restarts the interrupted playing.

7 EXCHANGE button [ⓕ]

Opens the disc storage door without retracting the disc currently in the play position, and permits to change discs in the slots positioned in the front.

8 RANDOM button [ⓖ]

Selects or deselects the RANDOM playback function (see the description of playback modes).

9 INTRO button [ⓗ]

Selects or deselects the INTRO playback function (see the description of playback modes).

10 REPEAT button [ⓘ]

Selects or deselects the REPEAT or REPEAT 1 playback function (see the description of playback modes).

11 PLAY MODE button [ⓙ , ⓚ , ⓛ]

Selects in turn a mode of playing successive discs continuously (CONTINUE), one disc only (ONE DISC), or according to a program (PROGRAM). Refer to the description of each playback mode for details.

12 MEMORY button [ⓜ]

Enters specified disc and track numbers as a program step in the PROGRAM mode.

13 CALL button [ⓝ]

Displays the programmed steps for review or deletion in the PROGRAM mode.

14 CANCEL button [ⓞ]

Deletes the currently displayed program step (disc and track numbers) in the PROGRAM mode.

15 ⏮ (track skip/search backward) button [ⓐ , ⓑ]

Skip tracks or search for a track backward. Holding down this button causes playback to fast reverse.

16 ⏭ (track skip/search forward) button [ⓓ , ⓔ]

Skip tracks or search for a track forward. Holding down this button causes playback to fast forward.

17 DISC/TRACK jog dial

Used to select a disc or track — the DISC or TRACK button located below the dial determines the dial function. "JOG" and "DISC" or "TRACK" will be shown on the display when the function is selected.

18 DISC EJECT button

Raises the disc in the load/unload position of the disc storage when the door is open.

Pressing this button when the door is closed retrieves the disc from the play position and brings it to the load/unload position. The disc will then be popped up when the door is opened.

19 DISC button [ⓙ]

Selects the DISC/TRACK jog dial function for discs.

20 TRACK button [ⓚ]

Selects the DISC/TRACK jog dial function for tracks.

Display

The information shown on the display of the control panel includes: current playback mode, function, disc (slot) and track numbers, program step number, track and total playing times, jog dial function, operation status, and track number table. The display with all elements shown is illustrated below:

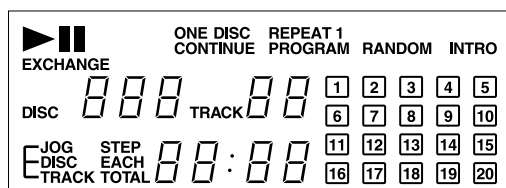

The track number table shows the tracks selected for the currently selected/displayed disc. When a track is specified as the starting track, all track numbers following the specified track will be shown. The track number display is available only up to 20, however.

Remote control

Numbers in brackets following button names indicate their counterparts on the control panel.

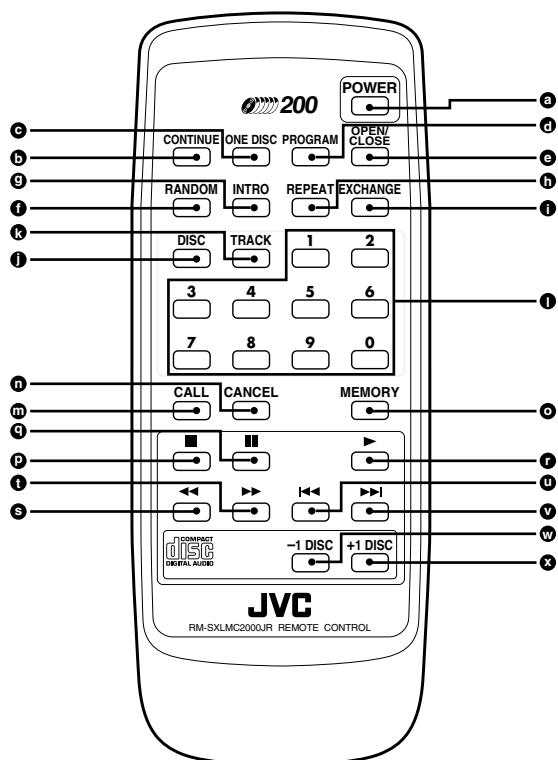

a POWER button [1]

b CONTINUE button

Directly selects the mode of playing successive discs continuously — instead of selecting the CONTINUE mode using the PLAY MODE button 11 on the front panel.

c ONE DISC button

Directly selects the mode of playing one disc only — instead of selecting the ONE DISC mode using the PLAY MODE button 11 on the front panel.

d PROGRAM button

Directly selects the mode of playing discs and tracks according to a program — instead of selecting the PROGRAM mode using the PLAY MODE button 11 on the front panel.

e OPEN/CLOSE button [4]

f RANDOM button [8]

g INTRO button [9]

h REPEAT button [10]

i EXCHANGE button [7]

j DISC button [19]

k TRACK button [20]

l Numeric buttons (0 through 9)

Used to specify a disc or track number.

m CALL button [13]

n CANCEL button [14]

o MEMORY button [12]

p (stop) button [5]

Stops playing the disc. Pressing the button in the PROGRAM mode clears all program steps if the unit is stopped.

q (pause) button

Temporarily interrupts the playing of the disc.

r (play) button

Starts playing the disc, or restarts the interrupted playing.

s (search reverse) button

Search through a track in reverse.

t (search forward) button

Searches through a track forward.

u (track skip backward) button

Skips tracks backward.

v (track skip forward) button

Skips tracks forward.

w - 1 DISC (disc skip backward) button

Skips discs backward.

x + 1 DISC (disc skip forward) button

Skips discs forward.

BASIC OPERATION

Turning the power on

Check that the standby indicator on the control panel is lit. Then press the POWER button either on the control panel or remote control.

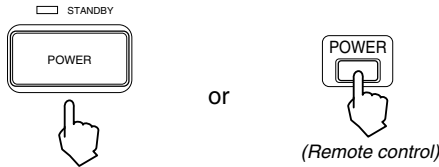

To turn the power off, press the button again lighting the standby indicator.

NOTE: Keeping the unit in the standby state consumes a minimal 6.5 watts. If necessary, unplug the power cord from the wall socket to turn off the power completely.

Loading compact discs

Also see Page 13 for the manner of handling and taking care of compact discs.

1. Press the OPEN/CLOSE button either on the control panel or remote control, opening the disc storage door and exposing carousel slots. "d-OP" is shown in the display.

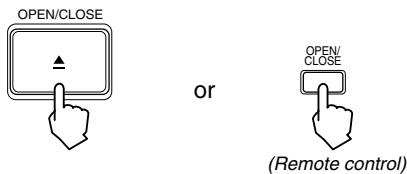

2. To select a specific slot to load a disc, press the DISC button and turn the DISC/TRACK jog dial, to specify the required slot number, which is shown as "DISC" number on the display. The carousel rotates to bring the specified slot to the load/unload position, which is in the center of the storage area.

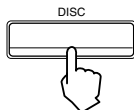

3. Place the disc in a slot, with its label facing to the left.

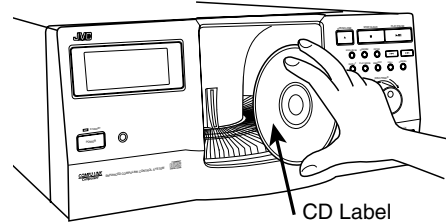

CAUTION

- Do not put anything except CDs in the storage area.
- 8 cm CDs cannot be played back in this unit.
- Be careful not to touch the playback mechanism in the unit.
- Up to 25 discs can be accessed at one time. Trying to insert or remove a disc which is not in the loading area may result in damage to the discs and unit.
- The disc needs to be placed vertically in the storage slot of this component. After taking the disc out of its case, grip the rim of the disc between your thumb and middle finger — be sure to keep the fingers on the narrow, outermost strip where the surface is solidly bright.
- Do not try to put more than one disc in a single slot. The unit will be damaged.

4. Repeat step 3, or steps 2 and 3, to load additional discs in the storage. Up to 200 discs can be loaded.
5. When all necessary discs have been loaded, press the OPEN/CLOSE button to close the storage door. "d-CL" is shown in the display.

CAUTION

Make sure to remove your hand from the storage opening before pressing the OPEN/CLOSE button.

Unloading/changing discs

1. Press the OPEN/CLOSE button to eject a disc in the playback position for unloading or changing.
2. To unload or change discs in other slots, press the DISC button and specify the slot number using the jog dial. The specified disc will be brought to the load/unload position. Then press the DISC EJECT button to raise the disc up.

Repeat this step to unload or change any additional discs.

3. When unloading or changing is completed, press the OPEN/CLOSE button to close the door. The disc in the load/unload position at this time will then be shifted to the play position.

Playing discs

1 Selecting a playback mode

There are three main playback modes, namely CONTINUE, ONE DISC, and PROGRAM; each has selective playback functions. (See the following pages for the description of the playback modes and functions.)

Select the mode using the PLAY MODE button on the control panel, or the CONTINUE, ONE DISC, or PROGRAM button on the remote controller.



2 Selecting a disc to play

To select a disc for playing, press the DISC button and then use the DISC/TRACK jog dial, or use the - 1 DISC or + 1 DISC buttons or numeric buttons on the remote control, showing the DISC (slot) number on the display.

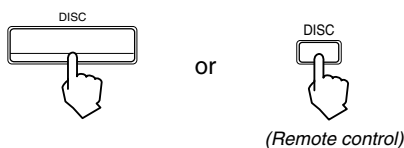

NOTE: When you use the numeric buttons to specify the disc or track numbers, press the button in the order of larger digit. For example, press "5," then "2" for "52." Press "1," "4," and then "8" for "148."

3 Selecting a track

To select a track of the selected disc, from which the disc is to be played instead of starting from the beginning, press the TRACK button and then use the DISC/TRACK jog dial, ◀▶ or ▶▶ buttons or use the numeric buttons on the remote control, showing the required TRACK number on the display.

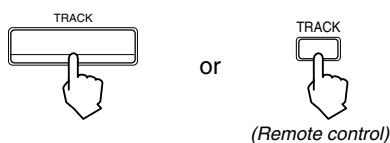

4 Starting the disc

Press the PLAY/PAUSE button or the ▶ button to play the selected disc or track.

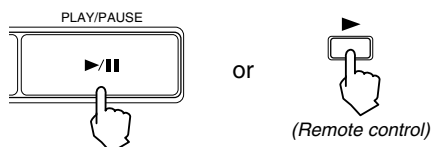

NOTE:

- If the disc storage door is open when playback starts, the door closes automatically.
- After specifying the disc to be played and pressing the TRACK button, playback will begin automatically.
- Once disc playback is started, in order to specify a track number to be played, the PLAY/PAUSE button or the ▶ button on the remote control must be pressed within five seconds.

• Interrupting the playback

Press the PLAY/PAUSE button or the ■■ button on the remote control to temporarily interrupt the playing, which can be resumed by pressing the PLAY/PAUSE button or the ▶ button on the remote control.

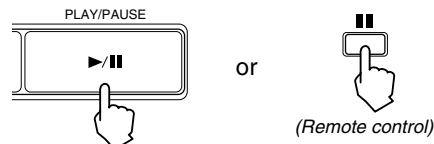

• Skipping to the different track in the same disc during playback

Proceed to steps 3 and 4. Press ◀◀ or ▶▶ buttons to skip tracks respectively.

• Skipping to the beginning of the different disc during playback

Proceed to steps 2, then press PLAY/PAUSE button on the front panel or the ▶ button on the remote control.

• Skipping to a track in the different disc during playback

Proceed to steps 2 to 4.

NOTE: When "JOG" is shown in the display, the ▶ button acts as the ENTER function and the pause function is disabled.

• Changing discs during playback

The carousel slots positioned in the front behind the disc storage door are accessible for loading, unloading, or changing discs while a disc is being played. Press the EXCHANGE button to open the door. Press the EXCHANGE or OPEN/CLOSE button to close the door.

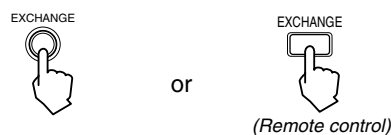

CAUTION

- Insert or remove discs very carefully at this time — the slots other than the center one are radially slanted toward the center of the carousel. Never try to rotate the carousel forcibly — it cannot be rotated when a disc is being played.
- Do not insert a disc outside of the loading area.
- A disc placed outside of the loading area is not registered and playback will not start.
- When you want to rotate the carousel, press the OPEN/CLOSE button after closing the disc storage door.
- After loading/unloading discs, promptly close the disc storage door. Playback will not occur with the door is in the open position.

Stopping the playback

Press the ■ button to stop and cancel the playing.

NOTE: When "JOG" is shown in the display, the ■ button acts as the CLEAR button and the stop function is disabled.

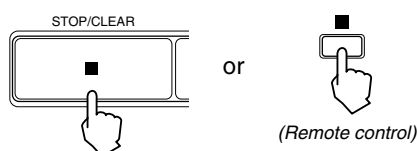

CONTINUE MODE PLAYBACK

Every loaded disc can be played entirely in the numerical order in the CONTINUE mode. After the playback of the last disc ends, the playback begins again from the first disc.

Discs and tracks can be selected randomly from all the loaded discs and played (RANDOM function).

One track can be played repeatedly in the basic mode as well as when the RANDOM function is selected (REPEAT-1 function).

The beginning of the first track of every loaded disc can be played for 15 seconds (INTRO function).

Basic mode

1. Select the mode.

Use the PLAY MODE button, or press the CONTINUE button on the remote control, to show "CONTINUE" on the display.

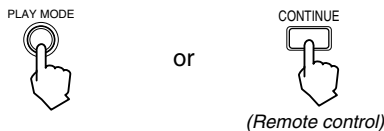

2. Select a disc you want to start playing. The discs following the specified disc will be played in succession.

Press the DISC button and then use the DISC/TRACK jog dial, or use the -1 DISC or +1 DISC button or numeric buttons on the remote control.

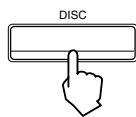

3. Select the track if you want to start playing the disc from a specific track.

Press the TRACK button and then use the DISC/TRACK jog dial, or use the ◀◀ or ▶▶ button or numeric buttons on the remote control.

4. Press the PLAY/PAUSE button or the ► button on the remote control to start playing.

NOTE: If you press the TRACK button after a disc is specified, playback starts automatically, however in order to play the specified track, you should press the ► button.

5. Discs and tracks can be skipped forward or backward during the playback using the ◀◀ or ▶▶ buttons. The playback can be paused or stopped in the normal manner. For further information, see [BASIC OPERATION] on pages 7 and 8.

Playing discs in random order

To play every disc in the storage in random order, press the RANDOM button showing "RANDOM" on the display. Then start the disc.

Playback order is continuous and discs and tracks are randomly selected. There is an approximately fifteen second pause between tracks.

Press the RANDOM button again while playback is stopped to cancel the function, clearing the indication from the display.

Playing a track repeatedly

A track of the selected disc can be played repeatedly. With a disc selected, press the REPEAT button, and select to show "REPEAT 1" on the display. Then start the disc to play the selected track repeatedly until you stop it.

This function can be used in the basic CONTINUE mode as well as when the RANDOM function is on.

Press the REPEAT button once to cancel the function, clearing the indication from the display.

NOTE: The REPEAT function is not available in the CONTINUE mode, as all discs are already being played back continuously.

Playing only the beginning of each disc's first track

To scan the first tracks of all discs, press the INTRO button to show "INTRO" on the display and the ► button. The beginning part of the first track of each disc will be played for 15 seconds successively.

Press the INTRO button again to cancel the function, clearing the indication from the display. This function will continue until the ■ button is pressed.

One disc can be selected and played entirely in the ONE DISC mode. The starting track may be specified.

Every track of the disc can be played once in a random order (RANDOM function).

The entire disc can be played repeatedly (REPEAT function) or one selected track can be played repeatedly (REPEAT-1 function) in the basic mode as well as when the RANDOM function is selected.

The beginning part of every track of the disc can be played for 15 seconds (INTRO function).

Basic mode

1. Select the mode.
Use the PLAY MODE button, or press the ONE DISC button on the remote control, to show "ONE DISC" on the display.

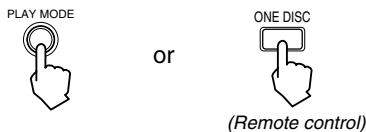

2. Select a disc you want to play.
Press the DISC button and then use the DISC/TRACK jog dial. The -1 DISC or +1DISC buttons as well as the numeric buttons on the remote control can also be used.

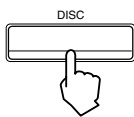

3. Select the track if you want to start playing the disc from a specific track.
Press the TRACK button and then use the DISC/TRACK jog dial. The ◀◀ or ▶▶ buttons as well as the numeric buttons on the remote control can also be used.

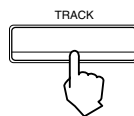

4. Press the PLAY/PAUSE button or the ▶ button on the remote control to start the disc, playing it from the first track or from the specified track through the last track.

NOTE: If you press the TRACK button after a disc is specified, playback starts automatically, however in order to play the specified track, you should press the ▶ button.

5. Tracks can be skipped forward or backward during the playback using the ◀◀ or ▶▶ button. The playback can be paused or stopped in the normal manner. For further information, see [BASIC OPERATION] on pages 7 and 8.

Playing the tracks in random order

To play every track of the disc, which has been selected in Step 2, press the RANDOM button following Step 2, to show "RANDOM" on the display. Then press the PLAY/PAUSE button or ▶ button on the remote control. The playback will be stopped when all tracks have been played.

Press the RANDOM button again to cancel the function, clearing the indication from the display during stop.

Playing the disc repeatedly

To repeatedly play the entire disc selected in Step 2 above, press the REPEAT button, and select and show "REPEAT" on the display. Then start the disc to play it repeatedly until stopped.

This function can be used in the basic ONE DISC mode as well as when the RANDOM function is effective. Press the REPEAT button twice to cancel the function, clearing the indication from the display.

Playing a track repeatedly

To repeatedly play the track selected in Step 3 above, press the REPEAT button, and select to show "REPEAT 1" on the display. Then start playing the disc to play the selected track repeatedly until stopped.

This function can be used in the basic ONE DISC mode as well as when the RANDOM function is effective. Press the REPEAT button once to cancel the function, clearing the indication from the display.

Playing only the beginning of each disc's first track

To scan the tracks of the selected disc, press the INTRO button to show "INTRO" on the display and the ▶ button. The beginning part of each track will be played for 15 seconds. The playback will be stopped when the scan is completed.

Press the INTRO button again to cancel the function, clearing the indication from the display.

PROGRAM MODE PLAYBACK

Discs and tracks can be selectively specified in a program and played according to the program in the PROGRAM mode.

The steps in the program can be played in a random order (RANDOM function).

The entire program can be played repeatedly (REPEAT function) or one program step can be selected and played repeatedly (REPEAT-1 function) in the basic mode as well as when the RANDOM function is selected.

Basic mode

1. Select the mode.
Use the PLAY MODE button, or press the PROGRAM button on the remote control, to show "PROGRAM" on the display.

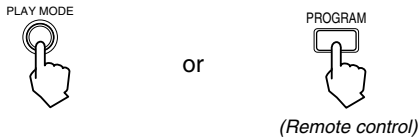

2. Specify disc or track numbers in the order you want to play in the following manner:
 - (a) Specify a disc number and a track number.
Press the DISC or TRACK button and then use the DISC/TRACK jog dial. The -1DISC or +1DISC buttons and the ◀◀ or ▶▶ buttons as well as the numeric buttons on the remote control can also be used.

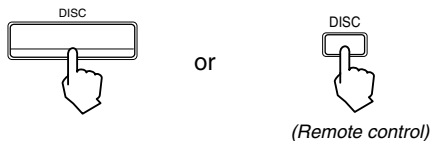

The track number can be omitted when programming a whole disc to be played.
Press the CANCEL button to cancel the specified disc and track numbers shown on the display.

- (b) Press the MEMORY button to register the specification as program step 1.

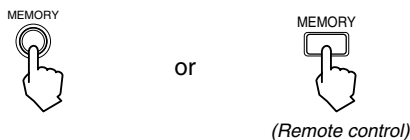

Up to 32 steps can be entered in one program. Each disc, when the whole disc is to be played, or each track programmed is counted as one step.

- (c) Repeat Steps (a) and (b) above to program additional the remaining steps.
3. Press the PLAY/PAUSE button or the ▶ button on the remote control to start playing according to the program.

Reviewing the steps:

Press the CALL button. One step is displayed each time the button is pressed.

Deleting a step:

Press the CALL button and display the necessary step. Then press the CANCEL button.

Adding a step:

An added step is placed in the last step automatically.

Deleting all steps:

Press the STOP/CLEAR button. The entire program will be cleared.

The program reviewing and modification procedures described above can only be performed when the playback is stopped.

The program will be retained and available whenever the PROGRAM mode is selected again as long as the unit is kept in the standby state.

If the AC power cord is disconnected from the outlet, the program will be erased.

Playing program steps in random order

To play every step in the program once in random order, press the RANDOM button, showing "RANDOM" on the display. Then start playing.

The playback will be stopped when all program steps have been played.

If the disc specified in the program is not in the disc storage, the playback stops. The playback starts again after you load the disc and press the PLAY/PAUSE button or the ▶ button on the remote control.

Press the RANDOM button again to cancel the function, clearing the indication from the display during stop.

Playing the program repeatedly

To repeat playback according to the program, press the REPEAT button, and select to show "REPEAT" on the display. Then start playing, which will be repeated until stopped.

This function can be used in the basic PROGRAM mode as well as when the RANDOM function is effective.

Press the REPEAT button twice to cancel the function, clearing the indication from the display during stop.

Playing a program step repeatedly

To repeatedly play a specific program step, select the step using ◀◀ or ▶▶ buttons during playback, press the REPEAT button twice to show "REPEAT 1" on the display. The selected step is played back repeatedly.

This function can be used in the basic PROGRAM mode as well as when the RANDOM function is effective.

Press the REPEAT button once to cancel the function, clearing the indication from the display.

The CompuLink system, which is a JVC-developed remote control system, links JVC audio components to establish systematized operation control of the linked components.

COMPULINK
Component

NOTE: There are three versions of the CompuLink system: CompuLink-1, -2, and -3. Although they are basically compatible, some functions may not be available with the older versions (refer to the instructions manual of the component for the information).

The CompuLink-3 Remote Control System provides the following functions:

Automatic power on/off

Turning a linked component on or off will automatically turn the amplifier/receiver on or off.

Selecting a source on the amplifier/receiver will turn on the relevant component.

CAUTION

- Be sure to use the accessory CompuLink cable for the connection.
- The operation may be disrupted if the power supply to a component is interrupted, in which case turn off all linked components and turn them on again.

Automatic source selection

Selecting a source on the connected amplifier/receiver will automatically turn on the relevant component and start its operation. Starting a linked component will automatically select the relevant source on the amplifier/receiver.

Synchronized recording

This function is effective when a JVC cassette deck or MD recorder is linked in the CompuLink system, allowing simple, synchronized recording.

NOTE: Refer to the instruction manual of your cassette deck or MD recorder for the detail of the synchronized recording. Some functions are disabled in order to prevent the recording trouble during the synchronized recording.

HANDING AND TAKING CARE OF DISCS

Handling compact discs

Protect the disc from being scratched, warped, or damaged in any other way — the plastic disc can easily be damaged and the damaged disc disrupts sound reproduction and the player function.

Keep every disc in its case

Be sure to keep every disc in its case whenever it is taken out of the player. Placing one disc upon another without putting them in their cases will damage their recorded tracks.

Keep the label side clean

Do not attempt to put adhesive tape or paper nor write anything even on the label side of a disc.

Cleaning compact discs

If the underside of a disc is soiled with fingerprints, etc., use a piece of soft, dry cloth and wipe clean the surface from the inside to the outside in straight strokes. If that does not clean the surface, try with a piece of soft cloth moistened with water.

Never use alcohol, record cleaners, or anti-static agents.

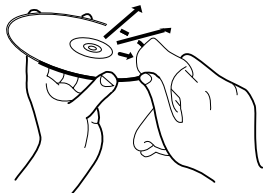

Storing compact discs

Do not store compact discs where they may be exposed to direct sunlight or extremes of temperature and humidity. Also, avoid leaving them in the car.

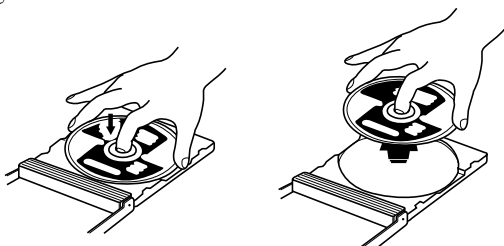

SPECIFICATIONS & PACKING LIST

General

Readable discs: CD

Other

Power requirements: AC 120V \sim , 60Hz
Power consumption: 11 W (POWER ON),
6.5 W (STANDBY mode)
Mass: 7.8 kg (17.2 lbs)
Dimensions (W x H x D): 435 x 199.5 x 482.5 mm
17-3/16 x 7-7/8 x 19 inch

Audio output

ANALOG OUT (pin jack x 2): 2.0 Vrms (1 kHz, 0dB)
DIGITAL OUT
(square optical connector jack): -24 \sim -15dB

The package contains the following items:

- 1 XL-MC2000 Compact Disc Automatic Changer
- 1 RM-SXLMC2000JR Remote Control
- 2 Remote control batteries (1.5V, R6P, AA)
- 1 Instructions manual
- 1 CD booklet file
- 1 Audio cord

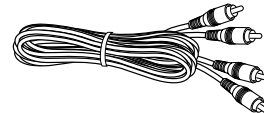

- 1 CompuLink cord

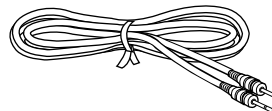

- 1 AC power cord



What appears to be a malfunction may not always be serious and can easily be corrected. The table below describes some typical problems and their remedies. Check them before calling your JVC dealer.

Symptom	Possible Cause	Remedy
The CD is not played.	The CD is not loaded.	Load the disc.
	The CD is not placed in the slot with its label on the left side.	Reload the disc correctly.
	A disc has been placed outside of the loading area	Specify the slot number and open the disc storage door. Then close the door.
	The CD is damaged.	Replace the disc with a new one.
	The AC power cord is disconnected.	Connect the cord securely.
	The audio cord is disconnected.	Connect the cord securely.
The sound is intermittent or harsh.	The CD is soiled.	Clean the surface using a piece of soft cloth.
	The CD is scratched or warped.	Replace the disc with a new one.
	A piece of paper or adhesive tape is stuck to the CD surface.	Remove it cleanly.
	The audio cord is placed close to the AC powercord.	Separate them.
The remote controller does not properly work.	The batteries are exhausted.	Replace the batteries.
	The remote control is not properly used.	Its maximum range is 7 meters (23 feet) and 30 degrees away from the component.
The component does not operate.	The internal circuitry is not properly functioning due to static electricity or other disturbance.	Disconnect the AC power cord and connect it again.

TO OUR VALUED CUSTOMER _____

THANK YOU FOR PURCHASING THIS JVC PRODUCT.
WE WANT TO HELP YOU ACHIEVE A PERFECT EXPERIENCE.

**NEED HELP ON HOW TO HOOK UP?
NEED ASSISTANCE ON HOW TO OPERATE?
NEED TO LOCATE A JVC SERVICE CENTER?
LIKE TO PURCHASE ACCESSORIES?**

JVC[®] IS HERE TO HELP!
TOLL FREE: 1(800)252-5722
<http://www.jvc.com>

Remember to retain your Bill of Sale for Warranty Service.

_____ **Do not attempt to service the product yourself** _____

Caution

To prevent electrical shock, do not open the cabinet.
There are no user serviceable parts inside.
Please refer to qualified service personnel for repairs.



LIMITED WARRANTY

1-1 USA ONLY

ONLY FOR PRODUCT PURCHASED IN U.S.A.

JVC Americas Corp. (JVC) warrants this product and all parts thereof, except as set forth below ONLY TO THE ORIGINAL RETAIL PURCHASER to be FREE FROM DEFECTIVE MATERIALS AND WORKMANSHIP from the date of original purchase for the period shown below. ("The Warranty Period")

PARTS	1 YR	LABOR	1 YR
-------	------	-------	------

THIS LIMITED WARRANTY IS VALID ONLY IN THE FIFTY (50) UNITED STATES, THE DISTRICT OF COLUMBIA AND IN THE COMMONWEALTH OF PUERTO RICO.

WHAT WE WILL DO:

If this product is found to be defective within the warranty period, JVC will repair or replace defective parts with new or rebuilt equivalents at no charge to the original owner. Such repair and replacement services shall be rendered by JVC during normal business hours at JVC authorized service centers. Parts used for replacement are warranted only for the remainder of the Warranty Period. All products may be brought to a JVC authorized service center on a carry-in basis. Color televisions with a screen size of 27" or greater qualify for in-home service. In such cases, a technician will come to your home and either repair the TV there or remove and return it if it cannot be repaired in your home.

WHAT YOU MUST DO FOR WARRANTY SERVICE:

Please do not return your product to the retailer

Instead, return your product to the JVC authorized service center nearest you. If shipping the product to the service center, please be sure to package it carefully, preferably in the original packaging, and include a brief description of the problem(s). Please call 1-800-252-5722 to locate the nearest JVC authorized service center. Service locations can also be obtained from our website <http://www.jvc.com>. If your product qualifies for in-home service, the service representative will require clear access to the product.

If you have any questions concerning your JVC Product, please contact our Customer Care Center at 800-252-5722

WHAT IS NOT COVERED:

This limited warranty provided by JVC does not cover:

1. Products which have been subject to abuse, accident, alteration, modification, tampering, negligence, misuse, faulty installation, lack of reasonable care, or if repaired or serviced by anyone other than a service facility authorized by JVC to render such service, or if affixed to any attachment not provided with the products, or if the model or serial number has been altered, tampered with, defaced or removed;
2. Initial installation, installation and removal from cabinets or mounting systems.
3. Operational adjustments covered in the Owner's Manual, normal maintenance, video and audio head cleaning;
4. Damage that occurs in shipment, due to act of God, and cosmetic damage;
5. Signal reception problems and failures due to line power surge;
6. User Removal Memory Devices/Video Pick-up Tubes/CCD Image Sensors are covered for 90 days from the date of purchase;
7. Accessories;
8. Batteries (except that Rechargeable Batteries are covered for 90 days from the date of purchase);
9. Products used for commercial purposes, including, but not limited to rental.
10. Loss of data resultant from malfunction of hard drive or other data storage device;

There are no express warranties except as listed above.

THE DURATION OF ANY IMPLIED WARRANTIES, INCLUDING THE IMPLIED WARRANTY OF MERCHANTABILITY, IS LIMITED TO THE DURATION OF THE EXPRESS WARRANTY HEREIN.

JVC SHALL NOT BE LIABLE FOR ANY LOSS OF USE OF THE PRODUCT, INCONVIENCE, OR ANY OTHER DAMAGES, WHETHER DIRECT, INCIDENTAL OR CONSEQUENTIAL (INCLUDING, WITHOUT LIMITATION, DAMAGE TO TAPES, RECORDS OR DISCS) RESULTING FROM THE USE OF THIS PRODUCT, OR ARISING OUT OF ANY BREACH OF THIS WARRANTY. ALL EXPRESS AND IMPLIED WARRANTIES, INCLUDING THE WARRANTIES OF MERCHANTABILITY AND FITNESS FOR PARTICULAR PURPOSE, ARE LIMITED TO THE WARRANTY PERIOD SET FORTH ABOVE.

Some states do not allow the exclusion of incidental or consequential damages or limitations on how long an implied warranty lasts, so these limitations or exclusions may not apply to you. This warranty gives you specific legal rights and you may also have other rights which vary from state to state.

JVC AMERICAS CORP.

1700 Valley Road, Wayne, New Jersey 07470
<http://www.jvc.com>

REFURBISHED PRODUCTS CARRY A SEPARATE WARRANTY, THIS WARRANTY DOES NOT APPLY. FOR DETAIL OF REFURBISHED PRODUCT WARRANTY, PLEASE REFER TO THE REFURBISHED PRODUCT WARRANTY INFORMATION PACKAGED WITH EACH REFURBISHED PRODUCT.

For customer use:

Enter below the Model No. and Serial No. which is located either on the rear, bottom or side of the cabinet. Retain this information for future reference.

Model No. :	Serial No. :
Purchase date :	Name of dealer :

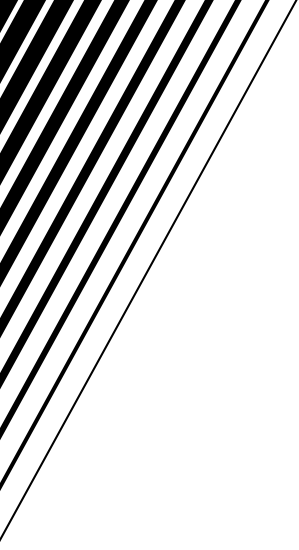

JVC



EN.

© 1999 Victor Company of Japan, Limited

Download from www.Somanuals.com. All Manuals Search And Download.

0806SKMSANJEIN

Free Manuals Download Website

<http://myh66.com>

<http://usermanuals.us>

<http://www.somanuals.com>

<http://www.4manuals.cc>

<http://www.manual-lib.com>

<http://www.404manual.com>

<http://www.luxmanual.com>

<http://aubethermostatmanual.com>

Golf course search by state

<http://golfingnear.com>

Email search by domain

<http://emailbydomain.com>

Auto manuals search

<http://auto.somanuals.com>

TV manuals search

<http://tv.somanuals.com>