

# JVC



## COLOUR TELEVISION

**DigiPure**

100Hz & PROGRESSIVE SCAN

# HV-29WH11

### Contents

Setting up your TV . . . . .	3
TV buttons and functions . . . . .	6
Remote control buttons and functions . . . . .	8
Using the TV's menu . . . . .	14
Basic operation . . . . .	14
PICTURE SETTING menu . . . . .	15
PICTURE FEATURES menu . . . . .	16
SOUND SETTING menu . . . . .	20
FEATURES menu . . . . .	21
INSTALL menu . . . . .	24
Additional preparation . . . . .	29
Troubleshooting . . . . .	31
Specification . . . . .	34

## INSTRUCTIONS



GGT0021-001A-H  
0803-CR-JMT

© 2003 VICTOR COMPANY OF JAPAN, LIMITED

Thank you for buying this JVC colour television.

To make sure you understand how to use your new TV, please read this manual thoroughly before you begin.

**WARNING: TO PREVENT FIRE OR SHOCK HAZARD, DO NOT EXPOSE THIS APPLIANCE TO RAIN OR MOISTURE.**

**CAUTION: TO ENSURE PERSONAL SAFETY, OBSERVE THE FOLLOWING RULES REGARDING THE USE OF THIS TV.**

- 1 Operate only from the power source indicated on the rear of the TV.
- 2 Avoid damaging the power cord and mains plug. When unplugging the TV, grasp the mains plug. Do not pull on the power cord.
- 3 Never block or cover the ventilation openings.  
Never install the TV where good ventilation is unattainable.  
When installing this TV, leave spaces for ventilation around the TV of more than the minimum distances as shown.

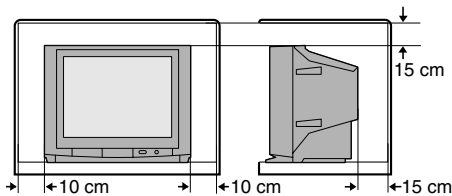

- 4 Do not allow objects or liquid into the cabinet openings.
- 5 In the event of a fault, unplug the unit and call a service technician. Do not attempt to repair it yourself or remove the rear cover.
- 6 The surface of the TV screen is easily damaged. Be very careful with it when handling the TV. Should the TV screen become soiled, wipe it with a soft dry cloth. Never use rub it forcefully. Never use any cleaner or detergent on it.
- 7 If you are not going to use this TV for a long period of time, be sure to disconnect the AC plug from the AC socket.
- 8 The apparatus shall not be exposed to dripping or splashing and that no objects filled with liquids, such as vases, shall be placed on the apparatus.

# Setting up your TV

## CAUTION

- Turn off all the equipment including the TV before connecting anything.

## 1 Connecting the aerial and VCR

- Aerial cable is not supplied. Use a good quality 75-ohm coaxial cable.
- Read the manual that came with the VCR before connecting.

### If not connecting a VCR (see Fig. A):

Connect an aerial cable to the aerial socket on this TV.

### If connecting a VCR (see Fig. B):

**1 Connect the aerial cable to the aerial input socket on the VCR, and connect the VCR and TV with another aerial cable.**

**2 Connect the VCR's VIDEO OUT (video output) jack and the TV's VIDEO jack with a video cable.**

### To connect a VCR to the TV with an S-VIDEO cable:

Connect the VCR's S-VIDEO OUT (S-VIDEO output) connector and TV's S connector with an S-VIDEO cable (A), instead of connecting with a video cable.

**3 Connect the VCR's VIDEO OUT (audio L/R output) jacks and the TV's AUDIO jacks (L/MONO and R) with an audio cable.**

- If the VCR's audio output is in mono, connect the VCR's AUDIO OUT (audio output) jack and the TV's AUDIO L/ MONO jack with an audio cable.

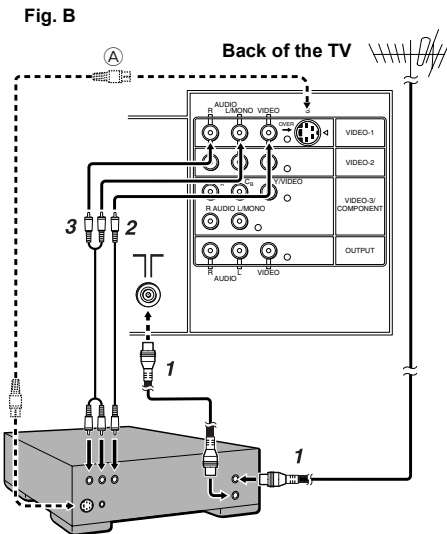
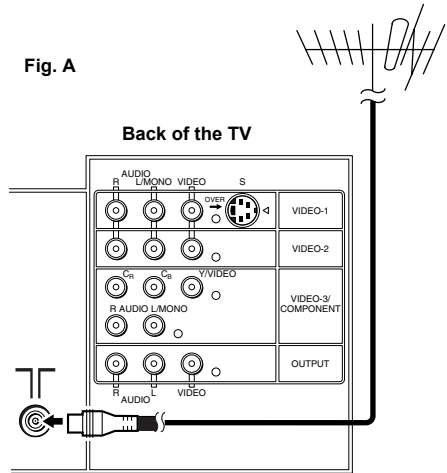

## 2 Connecting the power cord

Connect the mains plug to the AC outlet.

## 3 Putting the batteries into the remote control

Use two AA/R6 batteries.

Insert the batteries from the  $\ominus$  end, making sure the  $\oplus$  and  $\ominus$  polarities are correct.

- Follow the warnings printed on the batteries.
- If the remote control does not work properly, replace the batteries.
- The batteries we supply are only for setting up and testing your TV. Please replace them as soon as necessary.

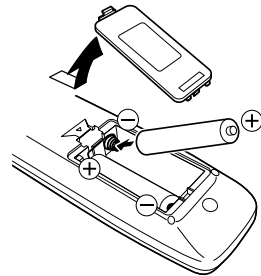

## 4 Making the initial settings

When the TV is first turned on, it enters the initial setting mode, and the JVC logo is displayed.

### 1 Press the main power button on the TV.

The TV is turned on, and the JVC logo appears.

- If the POWER lamp on the TV lights red and does not change to green, your TV is in the standby mode. Press the POWER button on the remote control to turn the TV on.
- If the JVC logo does not appear, your TV has already been turned before. In this case, use the “LANGUAGE” and “AUTO PROGRAM” functions to make the initial settings. For details, see “INSTALL menu” on page 24.

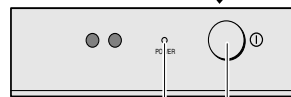
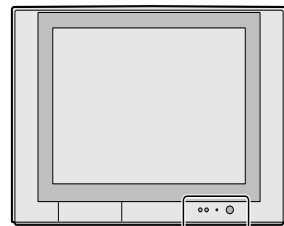

POWER lamp

Main power button

### 2 Press the MENU/OK button.

The LANGUAGE menu appears. You can choose a language for the on-screen language.



**3 Press the ▼/▲ buttons to choose ENGLISH. Then press the MENU/ OK button.**

The AUTO PROGRAM function starts. The TV channels you receive are automatically stored in the PR (programme numbers) LIST.

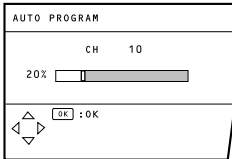

- To stop the AUTO PROGRAM function, press the MENU/OK button.

**4 After the TV channels have been stored in the programme numbers (PR) list, the EDIT menu appears.**

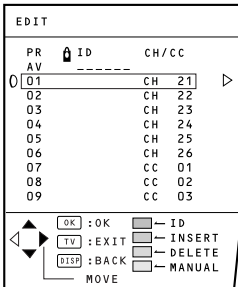

- You can proceed to edit the programme numbers list using the EDIT/MANUAL function. For details, see “EDIT/MANUAL” on page 25.
- If a TV channel you want to view is not stored in the programme numbers list, you can register it using the MANUAL function. For details, see “EDIT/MANUAL” on page 25.
- The AUTO PROGRAM function does not store a TV channel to the programme number 0 (AV).
- If you do not need to use the EDIT/MANUAL function, press the MENU/ OK button to close the EDIT menu.

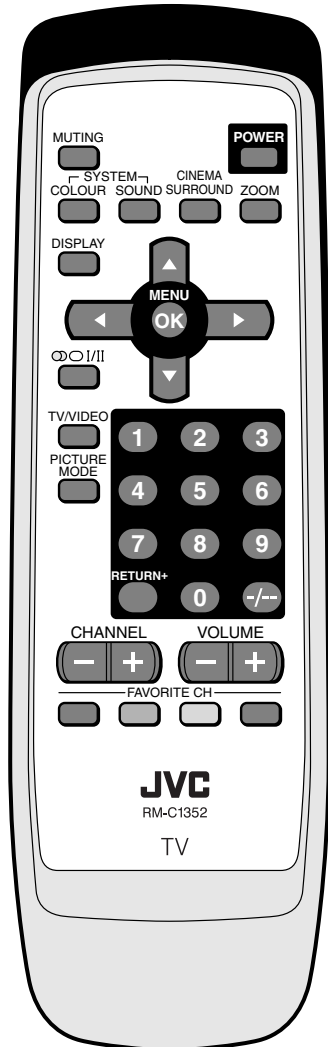

**Now, setting up is complete. Please enjoy your new JVC TV!**

# TV buttons and functions

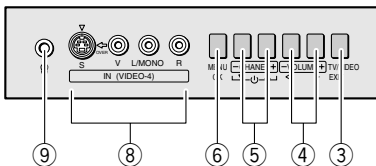
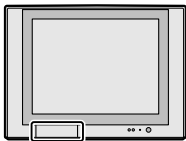
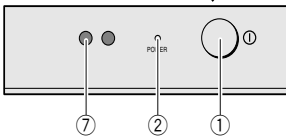
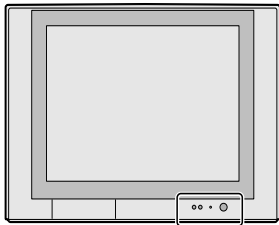

## Turn the main power on

Press the main power button ①.

The POWER lamp ② lights red and your TV is in the standby mode.

**To turn the main power off:**

Press the main power button again. The POWER lamp ② goes off.

## Turn the TV on from standby mode

Press the CHANNEL-/+ buttons ⑤.

The POWER lamp ② lights red to green and your TV will be turned on.

- You can also turn on the TV by pressing the TV/VIDEO button ③ while it is in standby mode.

## Choose a TV channel

Press the CHANNEL-/+ buttons ⑤.

## Choose a VIDEO terminal

Press the TV/VIDEO button ③ or CHANNEL-/+ buttons ⑤.

## Adjust the volume

Press the VOLUME-/+ buttons ④.

The volume level indicator appears.

## MENU button ⑥

Press to open the menu.

For details, see "Operation with the buttons on the TV" on page 15.

## Remote control sensor ⑦ (Behind the cover)

## VIDEO-4 terminal ⑧

See page 29.

## Headphone jack ⑨

Connect the headphones with a stereo mini-jack (3.5mm in diameter).

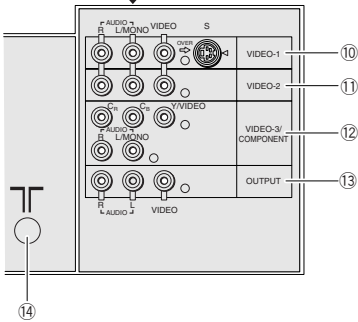
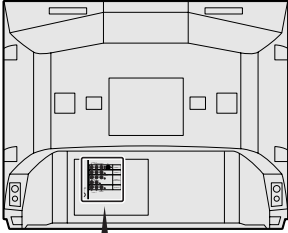

**VIDEO-1 terminal ⑩**

- See pages 3 and 29.

**VIDEO-2 terminal ⑪**

- See page 29.

**VIDEO-3/COMPONENT terminal ⑫**

- See pages 23 and 29.

**OUTPUT terminal ⑬**

- See page 29.

**Aerial socket ⑭**

Connect the aerial cable.

- See page 3.



# Remote control buttons and functions

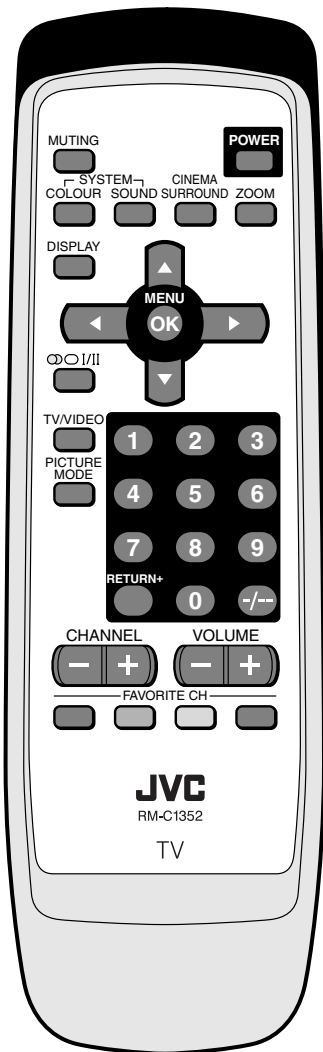

## Turn the TV on from standby mode

### Press the POWER button.

The POWER lamp lights red to green and your TV will be turned on.

- You can turn on the TV from the standby mode by pressing the TV/ VIDEO button, the CHANNEL-/ + buttons or the number buttons.

### To turn the TV off:

Press the POWER button again.

The POWER lamp changes from green to red and the TV enters standby mode.

## Choose a TV channel

Choose a programme number in which a TV channel has been set.

### Press the CHANNEL-/ + buttons or enter the programme number (PR) with the number buttons.

- If you want to put a two-digit channel into the TV, press the -/--button to change to the two-digit entry system.
- You can select a channel from the PR LIST. For details, see "DISPLAY button" on page 11.
- If you do not have a clear picture or no colour appears, follow the operation procedure "COLOUR SYSTEM button" on page 11.

## Adjust the volume

### Press the VOLUME-/ + buttons.

## Watch images from an external device

Choose a VIDEO terminal to which the external device has been connected.

### Press the TV/VIDEO button.

- You can choose a VIDEO terminal with the CHANNEL-/ + buttons or from the PR LIST.

### To return to a TV channel:

Press the TV/VIDEO button, the CHANNEL-/ + buttons or the number buttons.



## MUTING button

Press the MUTING button to turn off the volume. Pressing the MUTING button again resumes the previous volume level.

## ZOOM button

You can change the screen size according to the picture aspect ratio. Choose the optimum one from the following ZOOM modes.

**Press the ZOOM button to choose a mode.**

- The ZOOM button works only in the normal screen.

### REGULAR:

Use to view a normal picture (4:3 aspect ratio) as its original size is.



### ZOOM:

You can zoom up the Wide picture (16:9 aspect ratio) to fill the TV screen.

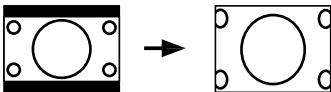

- The left side and right side of the Wide picture (16:9 aspect ratio) will be cut off.

### 16:9:

This mode converts a normal picture (4:3 aspect ratio) into a Wide picture (16:9 aspect ratio).

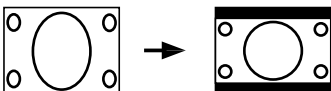

- Use for picture with a 16:9 aspect ratio that have been squeezed into a normal picture (4:3 aspect ratio), you can restore their original dimensions.

## CINEMA SURROUND button

You can enjoy an enhanced sound for a wider audience by using CINEMA SURROUND function.

**Press the CINEMA SURROUND button to select one of CINEMA SURROUND modes.**

### HIGH/LOW:

When you listen to the stereo sound, please select HIGH or LOW mode.

You can enjoy the sound for a wider audience similar to the experience at the theatre.

- In case that you setting up the CINEMA SURROUND function to HIGH mode, there may be slight volume distortion. In case that occurs, please switch the HIGH mode to LOW mode, the effect of CINEMA SURROUND functions will be less noticeable, however, the volume distortion will be corrected.

### MONO:

Select the MONO mode, when you listen to the mono sound.

You can enjoy the sound for a wider audience similar to stereo sound.

### OFF:

The CINEMA SURROUND function switches off.

## PICTURE MODE button

You can choose one of three PICTURE MODEs (three kinds of picture setting) to adjust the picture settings automatically.

**Press the PICTURE MODE button to choose a mode.**

### BRIGHT:

Heightens contrast and sharpness.

### STANDARD:

Standardizes picture adjustment.

### SOFT:

Softens contrast and sharpness.

## RETURN+ button

The RETURN+ button has two functions; the RETURN+ function and the RETURN function. If a channel has been registered as the "Return Channel", the RETURN+ function operates. If there is no setting for the "Return Channel", the RETURN function operates.

## RETURN+ function

By registering a channel you frequently view as the "Return Channel", you can select that channel at any time simply by pressing the RETURN+ button.

### To register a TV channel as the "Return Channel":

Choose the Programme number to which the channel you want to register has been set, and press the RETURN+ button and hold for more than 3 seconds continuously. "RETURN PLUS PROGRAMMED!" is displayed and the registration is completed.

### To cancel a TV channel registered as the "Return Channel":

While viewing any TV channel, press the RETURN+ button and hold for more than 3 seconds continuously. "RETURN PLUS CANCELED!" is displayed and the registration is cancelled.

- When you turn off the TV, the registration for the "Return Channel" is cancelled.
- If you want to view the "Return Channel" and another TV channel alternately, first choose a channel other than the "Return Channel". And then press the RETURN+ button to change the channel to the "Return Channel" In this way, you can view two channels alternately by pressing the RETURN+ button.

## RETURN function

The TV temporarily memorises the TV channel that was chosen right before the current TV channel as the "Last Channel". By pressing the RETURN+ button, you can alternately view the current TV channel and the "Last Channel".

- If you want to view two channels alternately by using the RETURN function, first choose one TV channel and then choose the other TV channel with the Number buttons. If you choose the TV channel without using the Number buttons, there are cases where a channel other than the one you first chose is registered as the "Last Channel".

## ∞/I/II button

When you are viewing a bilingual broadcast programme, you can choose the sound from Bilingual I (Sub I) or Bilingual II (Sub II).

- When the stereo broadcasting is received poorly, you can change from stereo to mono sound so that you can hear the broadcast more clearly and easily.

### Press the ∞/I/II button to choose a sound mode.

∞ : Stereo sound

○ : mono sound

I : Bilingual I (sub I)

II : Bilingual II (sub II)

MONO : Cancels the Multi Sound function, and the sound becomes monaural.

- The sound mode you can choose differs depending on the TV programme.
- This function does not work in the VIDEO modes.

## DISPLAY button

You can display the PR LIST, programme number or VIDEO terminal number on the screen.

### Press the DISPLAY button.

Pressing the DISPLAY button changes the display as follows:

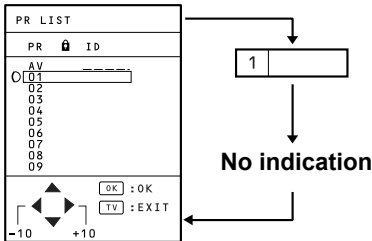

## Choose a TV channel or a VIDEO terminal

**1 Press the DISPLAY button to display the PR LIST.**

**2 Press the ▼/▲ and ◀/▶ buttons to choose a programme number or VIDEO terminal.**

**Then press the MENU/OK button.**

- For programme numbers with the CHANNEL GUARD function set, the  (CHANNEL GUARD) mark is displayed next to the programme number in the PR LIST.
- The VIDEO terminals are registered after the programme number PR99.
- The AV channel (channel number 0) in the PR LIST will be chosen only if you connect the VCR to the TV with an aerial cable without connecting a video cable.

## COLOUR SYSTEM button

The colour system is chosen automatically. However, if the picture is not clear or no colour appears, choose the colour system manually.

**Press the COLOUR SYSTEM button to choose the appropriate colour system.**

### AUTO:

This function detects a colour system from the input signal.

- The AUTO mode may not function properly if you have poor signal quality. If the picture is abnormal in the AUTO mode, choose another colour system manually.
- The AUTO mode detects a colour system from the input signal and chooses the appropriate colour system automatically.
- For the colour systems in each country or region, see the table "BROADCASTING SYSTEMS" on page 12.

**PAL/SECAM/NTSC3.58/NTSC4.43:**  
PAL, SECAM, or NTSC colour system.

## SOUND SYSTEM button

The sound system is chosen automatically. However, if you cannot hear the sound normally even when the picture appears normally, choose the sound system manually.

**Press the SOUND SYSTEM button to choose the appropriate sound system.**

B/G : B/G system  
I : I system  
D/K : D/K system  
M : M system

- This function does not work in the VIDEO mode.
- For the sound systems in each country or region, see the table "BROADCASTING SYSTEMS" on page 12.

## BROADCASTING SYSTEMS

For sound and colour systems in your country or region, refer to the table below:

### COLOUR SYSTEM

Area	Country or Region	System
Asia, Middle East	Bahrain, Kuwait, Oman, Qatar, United Arab Emirates, Yemen, etc. Indonesia, Malaysia, Singapore, Thailand, India, etc.	PAL
	China, Vietnam, etc.	PAL
	Hong Kong, etc.	PAL
	Islamic Republic of Iran, Lebanon, Saudi Arabia, etc.	SECAM
Europe	Philippines, Taiwan, Myanmar, etc.	NTSC
	Russia, etc.	SECAM
	Czech Republic, Poland, etc.	PAL
	Germany, Holland, Belgium, etc. UK, etc.	PAL
Oceania	Australia, New Zealand, etc.	PAL
Africa	Republic of South Africa, etc.	PAL
	Nigeria, etc.	PAL
	Egypt, Morocco, etc.	SECAM

### SOUND SYSTEM

Area	Country or Region	System
Asia, Middle East	Bahrain, Kuwait, Oman, Qatar, United Arab Emirates, Yemen, etc. Indonesia, Malaysia, Singapore, Thailand, India, etc.	B/G
	China, Vietnam, etc.	D/K
	Hong Kong, etc.	I
	Islamic Republic of Iran, Lebanon, Saudi Arabia, etc.	B/G
Europe	Philippines, Taiwan, Myanmar, etc.	M
	Russia, etc.	D/K
	Czech Republic, Poland, etc.	D/K
	Germany, Holland, Belgium, etc. UK, etc.	B/G
Oceania	Australia, New Zealand, etc.	B/G
Africa	Republic of South Africa, etc.	I
	Nigeria, etc.	B/G
	Egypt, Morocco, etc.	B/G

## Favorite channel registration

You can register your favorite TV channels with the colour buttons (Red, Green, Yellow and Blue). After registration you can recall the favorite channel by pressing the colour button.

### 1 In the normal screen, choose a TV channel (PR01-99) you want to register.

For detailed operation, see "Choose a TV channel" on page 8.

### 2 Press and hold a colour button for 3 seconds or more.

Then "FAVORITE CHANNEL PROGRAMMED!" appears on the screen and the current channel is registered.

- If the chosen channel is already registered as the favorite channel, when a colour button is pressed, the registered colour button icon appears on the top right of the screen.

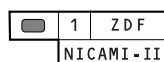

- You cannot register if the chosen channel is guarded with the CHANNEL GUARD function and the screen is blue, or if an on-screen menu is displayed.
- Even if you perform AUTO PROGRAM function, the registration made here will not be changed. (For AUTO PROGRAM, see page 24.)

## Recalling the favorite channel

Press the colour button, then the registered favorite channel will be displayed.

- You cannot recall the favorite channel in Menu mode where an on-screen menu is displayed.
- The picture effect dedicated for the colour button applies. For details, see "Setting the picture effect" on page 13.

## Setting the picture effect

Each colour button has a dedicated picture effect. When you choose a favorite channel with a colour button, the dedicated picture effect is used. When shipped, the factory set picture effect is used for this purpose. However, you can set this picture effect as required. For details, see “FAVORITE CH SETTING” on page 19.

- If you choose the favorite channel normally without using the colour button, the normal picture effect is used.

## Showing the favorite channels

Press the DISPLAY button to display the PR LIST.

You can see the favorite channel that has the registered colour button icon at the right of the channel number.

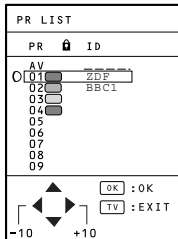

# Using the TV's menu

This TV has a number of functions you can operate using menus.

To fully utilize all your TV's functions, you need to understand the basic menu operating techniques fully.

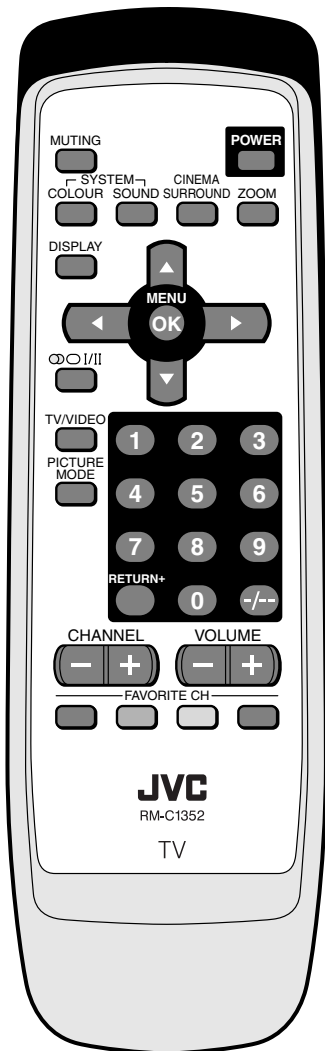

## Basic operation

- 1 Press the MENU/OK button to display the MENU (main menu).

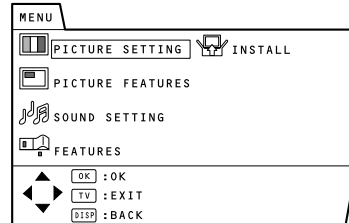

- The display appearing at the bottom of a menu indicates buttons on the remote control you can use when you operate a chosen function.

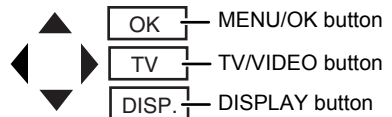

- 2 Press the ▼/▲ buttons or ◀/▶ to choose a menu title, and press the MENU/OK button.

The menu appears.

**To return to the previous menu:**

Press the DISPLAY button.

**To exit a menu instantly:**

Press the TV/VIDEO button.

- 3 Press the ▼/▲ buttons to choose a function.

- For details of the functions in the menus, see the following pages.

#### 4 Press the ◀/▶ buttons to choose the setting of that function.

- If you want to operate a function which appears only with its name, follow the descriptions of that function on the following pages.
- The display appearing at the bottom of a menu shows you a button on the remote control that you can use when you operate a chosen function.

#### 5 Press the MENU/OK button to complete the setting.

The menu disappears.

- When watching the television with the NTSC system, the menus as displayed at about half of their normal vertical size.

### Operation with the buttons on the TV

You can also operate the menus using the buttons on the front panel of the TV.

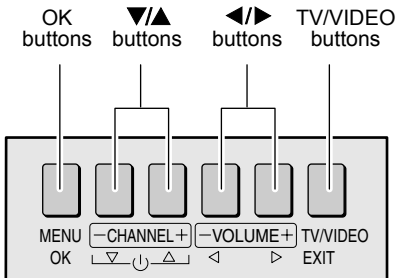

- There is no DISPLAY button on the front panel of the TV, which will be used for menu operation.

## PICTURE SETTING menu

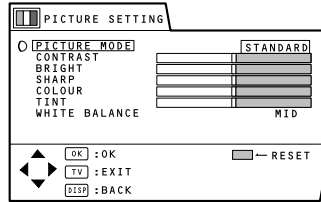

### ■ PICTURE MODE

You can choose one of three PICTURE MODES to adjust the picture settings automatically.

#### **BRIGHT:**

Heightens contrast and sharpness.

#### **STANDARD:**

Standardizes picture adjustment.

#### **SOFT:**

Softens contrast and sharpness.

- You can also operate the PICTURE MODE function with the PICTURE MODE button on the remote control. For details, see "PICTURE MODE button" on page 9.

### ■ Adjusting the picture

You can change the picture settings of each picture mode, as you like. The picture settings changed are stored in the picture mode.

#### **CONTRAST**

You can adjust the picture contrast.

- ◀ : lower
- ▶ : higher

#### **BRIGHT**

You can adjust the picture brightness.

- ◀ : darker
- ▶ : brighter

#### **SHARP**

You can adjust the picture sharpness.

- ◀ : softer
- ▶ : sharper

## COLOUR

You can adjust the picture colour.

- ◀ : lighter
- ▶ : deeper

## TINT

You can adjust the picture tint.

- ◀ : reddish
- ▶ : greenish
  - You can change the TINT setting (picture tint) only when the colour system is NTSC 3.58 or NTSC 4.43.
  - You cannot select the TINT function when receiving the Progressive video signal (525P signal).

### To return to the default settings in each PICTURE MODE:

Press the blue button. This will return the picture settings in the currently chosen PICTURE MODE to the default settings, and stores them in the PICTURE MODE again.

## ■ WHITE BALANCE

You can select one of three WHITE BALANCE modes (three tones of white) to adjust the white balance of the picture. Since white is the colour which is used as a reference for all the other colours, changing the WHITE BALANCE mode affects the appearance of all the other colours on the screen.

### COOL:

A bluish white. Using this mode when watching bright pictures allows you to enjoy a more vivid and bright picture.

### MID:

The normal white colour.

### WARM:

A radish white. Using this mode when watching films allows you to enjoy colours that are characteristic of films.

- You cannot select the WHITE BALANCE function in the 16:9 mode of the ZOOM function.

## PICTURE FEATURES menu

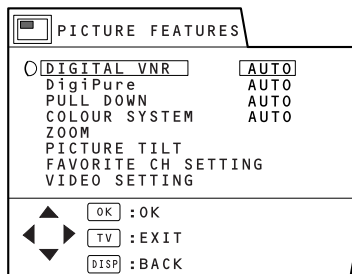

### ■ DIGITAL VNR

The DIGITAL VNR function cuts down the amount of noise in the original picture.

#### AUTO:

The TV will be automatically adjust the level of the DIGITAL VNR effect to match the amount of noise in the picture, giving you the best possible picture.

- If you set the DIGITAL VNR effect too high it can make the picture less sharp. It is recommended to use the AUTO setting if you can.

#### MAX:

The level of the DIGITAL VNR effect is set to the maximum. If you set the DIGITAL VNR function to AUTO but still notice some noise, change the setting from AUTO to MAX.

- The MAX setting is not suitable for high-quality pictures which contain a lot of noise.

#### OFF:

The level of the DIGITAL VNR effect is set to OFF.

#### MIN:

The level of the DIGITAL VNR effect is set to the minimum. If you set the DIGITAL VNR function to AUTO but feel that the sharpness of the original picture has not been reproduced fully, change the setting from AUTO to MIN.

- The MIN setting is not suitable for low-quality pictures which contain a lot of noise.



## ■ DigiPure

The DigiPure function uses the latest in digital technology to give you a natural looking picture. The DigiPure function includes the following two functions.

### **Digipure function:**

This function helps to create a natural looking picture by eliminating unnecessary edges from high-contrast and crisp images. Conversely, for images with low-contrast, edges are added to produce a sharper, more detailed picture.

You can choose from the DigiPure function settings of AUTO, MIN and MAX.

### **Picture motion compensation function:**

This function displays fast-moving pictures (for example, the players or ball in a football game) more smoothly and naturally on the screen.

### **AUTO:**

The TV will automatically adjust the level of the DigiPure effect to match the amount of noise in the picture, giving the best possible picture.

- If you set the DigiPure effect too high on a low-quality picture that contains a lot of noise, this may actually make the noise worse. It is recommended to use the AUTO setting if you can.

### **MAX:**

The level of the DigiPure effect is set to the maximum. If you set the DigiPure function to AUTO but feel that the original picture quality has not been reproduced fully, change the setting from AUTO to MAX.

- The MAX setting is not suitable for low-quality pictures which contain a lot of noise.

### **OFF:**

The DigiPure function is turned off.

### **MIN:**

The level of the DigiPure effect is set to the minimum. When you set the DigiPure function to AUTO and notice some noise, change the setting from AUTO to MIN.

- The MIN setting is not suitable for high-quality pictures which contain very little noise.

## ■ PULL DOWN

The PULL DOWN function displays a cinema film picture more smoothly and naturally on the screen.

### **AUTO:**

This function is turned on. Normally keep this function set to AUTO.

### **ON :**

This function is turned on.

### **OFF:**

This function is turned off.

- The motion may appear unnatural when viewing images with the NTSC colour system. To make the motion smoother, switch the PULL DOWN function from AUTO or ON to OFF.

## ■ COLOUR SYSTEM

The colour system is chosen automatically. However, if the picture is not clear or no colour appears, choose the colour system manually.

**1 Choose COLOUR SYSTEM, then press the ◀/▶ buttons to choose the appropriate colour system.**

- You can also operate the COLOUR SYSTEM function with the COLOUR SYSTEM button on the remote control. For details, see "COLOUR SYSTEM button" on page 11.

## ■ ZOOM

You can change the screen size according to the picture aspect ratio. Choose the optimum one from three ZOOM modes.

**1 Choose ZOOM, then press the MENU/OK button.**

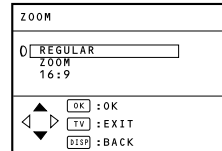

**2 Press the ▼/▲ buttons to choose a ZOOM mode. Then press the MENU/OK button.**

- You can choose a ZOOM mode from REGULAR, ZOOM or 16:9 modes. For details, see "ZOOM button" on page 9.

## ■ PICTURE TILT

There are cases where the Earth's magnetic force may make the picture tilt. If this happens, you can correct the picture tilt.

**1 Choose PICTURE TILT, then press the MENU/OK button.**

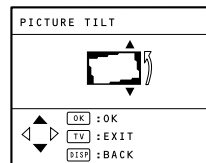

**2 Press the ▼/▲ buttons until the picture becomes level. Then press the MENU/OK button.**

## ■ FAVORITE CH SETTING

You can set a dedicated picture effect for the favorite channels registered to the colour buttons (Red, Green, Yellow and Blue). For favorite channel registration, see "Favorite channel registration" on page 12.

- 1 Choose **FAVORITE CH SETTING**, then press the **MENU/OK** button.

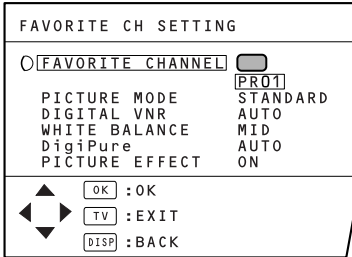

- 2 Press the **▼/▲** button to choose **FAVORITE CHANNEL**, then press the **◀/▶** button to choose the registered favorite channel.

Each time you press the **◀/▶** button, the colour button icon (Red, Green, Yellow or Blue) of the registered favorite channel and its channel number (e.g. PR1) appear.

- 3 Set the picture effect.

Press the **▼/▲** button to choose an item listed in the following table and press the **◀/▶** button to choose one of options.

- As explained in the table, if **PICTURE EFFECT** is set to **OFF**, the dedicated picture effect for the favorite channel is not used. In this case, normal picture effect is used.

- For details of each item, see "PICTURE MODE" on page 15, "DIGITAL VNR" on page 16, "WHITE BALANCE" on page 16, "DigiPure" on page 17.

Item	Options
PICTURE MODE	BRIGHT*, STANDARD, SOFT
DIGITAL VNR	AUTO*, MAX, OFF, MIN
WHITE BALANCE	COOL, MID*, WARM
DigiPure	AUTO*, MAX, OFF, MIN
PICTURE EFFECT	ON*: Above picture effect applies to the chosen favorite channel. OFF: No picture effect applies.

\*: When shipped

- 4 Press the **MENU/OK** button to complete the setting.

## ■ VIDEO SETTING

You can set a dedicated picture effect for the video inputs, VIDEO-1 to -4.

- 1 Choose **VIDEO SETTING**, then press the **MENU/OK** button.

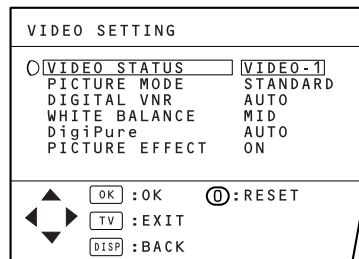

- 2 Press the **▼/▲** button to choose **VIDEO STATUS**, then press the **◀/▶** button to choose one of video inputs, **VIDEO-1** to **-4**.

### 3 Set the picture effect.

Press the **▼/▲** button to choose an item listed in the following table and press the **◀/▶** button to choose one of options.

- As explained in the table, the PICTURE EFFECT for the video inputs is set to OFF when shipped. To use it, you need to set it ON.

Item	Options
PICTURE MODE	BRIGHT*, STANDARD, SOFT
DIGITAL VNR	AUTO*, MAX, OFF, MIN
WHITE BALANCE	COOL, MID*, WARM
DigiPure	AUTO*, MAX, OFF, MIN
PICTURE EFFECT	ON: Above picture effect applies to the chosen video input. OFF*: No picture effect applies.

\*: When shipped

- For details of each item, see "PICTURE MODE" on page 15, "DIGITAL VNR" on page 16, "WHITE BALANCE" on page 16, "DigiPure" on page 17.
- Pressing the number button "0" will return the picture effect to the factory set value.

### 4 Press the MENU/OK button to complete the setting.

## SOUND SETTING menu

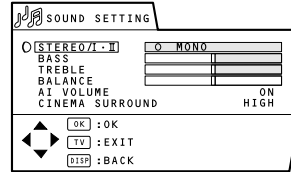

### ■ STEREO / I-II

When you are viewing a bilingual broadcast programme, you can choose the sound from Bilingual I (sub I) or Bilingual II (sub II). When the stereo broadcasting is received poorly, you can change from stereo to mono sound so that you can hear the broadcast more clearly and easily.

∞ : Stereo sound

○ : mono sound

I : Bilingual I (sub I)

II : Bilingual II (sub II)

MONO: Cancels the Multi Sound function, and the sound becomes monaural.

- The sound mode you can choose differs depending on the TV programme.
- This function does not work in the VIDEO modes.
- You can also operate the STEREO / I-II function with the ∞OI/II button. For details, see "∞OI/II button" on page 10.

### ■ Adjusting the sound

You can adjust the sound to your liking.

#### BASS

You can adjust the low tone of the sound.

◀ : weaker

▶ : stronger

#### TREBLE

You can adjust the high tone of the sound.

◀ : weaker

▶ : stronger

## BALANCE

You can adjust the volume balance between the left and right speakers.

- ◀ : turn the left speaker's volume level up.
- ▶ : turn the right speaker's volume level up.

## ■ AI VOLUME

You can prevent the sudden increase or decrease of sound that occurs when changing the channel to another channel or switching the VIDEO mode to another VIDEO mode.

### ON:

This function is turned on.

### OFF:

This function is turned off.

- The AI VOLUME function may not operate as expected if the sound input level from a broadcast station (or video software) is extremely low.

## ■ CINEMA SURROUND

You can enjoy Surround sound with a "live" effect by using the CINEMA SURROUND function.

- You can choose a CINEMA SURROUND mode from HIGH, LOW, MONO and OFF modes. For details, see "CINEMA SURROUND button" on page 9.
- You can also operate the CINEMA SURROUND function with the CINEMA SURROUND button. For details, see "CINEMA SURROUND button" on page 9.

## FEATURES menu

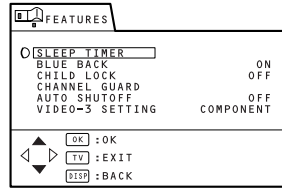

## ■ SLEEP TIMER

You can set the TV to automatically turn off after a set time.

- 1 Choose **SLEEP TIMER**, then press the **MENU/OK** button.

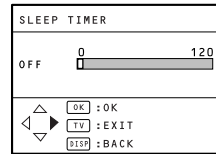

- 2 Press the ◀/▶ buttons to set the **period of time**.

The TV begins count down from the set time.

- You can set the period of time a maximum of 120 minutes (2 hours) in 10 minute steps.

### **To cancel this function:**

- Press the ◀ button to set a period of time to "OFF".

- 3 Press the **MENU/OK** button to **complete the setting**.

The menu disappears.

- One minute before this function turns off the TV, "GOOD NIGHT!" appears.
- This function cannot be used to turn off the TV's main power.
- When this function is on, you can display the SLEEP TIMER menu again to confirm or change the remaining time.

## ■ BLUE BACK

You can set the TV to automatically change to a blue screen and mute the sound if the signal is weak or absent, or when there is no input from an external device.

### ON:

This function is turned on.

### OFF:

This function is turned off.

## ■ CHILD LOCK

You can disable the front control buttons of the TV. When this function is set to ON, the TV can be operated only by using the remote control.

Use this function to prevent children from operating the TV at their own discretion (without parent consent).

### ON:

This function is turned on.

### OFF:

This function is turned off.

## ■ CHANNEL GUARD

When there is a TV channel you do not want your children to watch, you can lock out the channel. Even when a child chooses a programme number for a locked out channel the screen will change to blue and display  $\hat{u}$  so the channel cannot be viewed.

To set this function:

- 1 Choose **CHANNEL GUARD**, then press the number **0 (AV)** button.

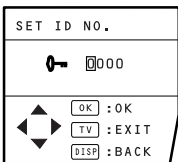

- 2 Set the ID number you want.

**To choose a number:**

Press the  $\blacktriangledown/\blacktriangle$  buttons.

**To move a cursor:**

Press the  $\blacktriangleleft/\blacktriangleright$  buttons.

- 3 Press the **MENU/OK** button.

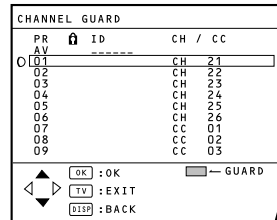

- 4 Press the  $\blacktriangledown/\blacktriangle$  buttons to choose a TV channel.

- The TV shows the TV programme which the chosen TV channel is now broadcasting.

- 5 Press the blue button to set this function to the TV channel.

$\hat{u}$  (CHANNEL GUARD) appears and the TV channel is locked.

**To cancel this function:**

Press the blue button again.

$\hat{u}$  (CHANNEL GUARD) disappears and the lock is released.

- 6 Press the **MENU/OK** button to complete the setting.

The menu disappears.

To view a locked TV channel:

- 1 Choose a programme number in which a TV channel locked with the number buttons or **PR LIST**.

The screen changes to blue and the  $\hat{u}$  (CHANNEL GUARD) appears.

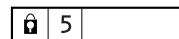

- You cannot choose a locked TV channel with the  $\blacktriangledown/\blacktriangle$  buttons.

- 2 Press the **DISPLAY** button to display "ID NO." (ID number input screen).

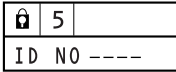

- 3 Press the number buttons to enter the ID number.

The lock is temporarily released so you can view the TV channel.

**If you have forgotten the ID number:**

Perform step 1 of "To set this function:" on page 22. After confirming the ID number, press the TV/VIDEO button to exit the menu.

- When you would like to cancel the CHANNEL GUARD function, you must perform the operation "To set this function" again.

■ **AUTO SHUTOFF**

You can set your TV to turn off if no signal is received for about 15 minutes or longer after the end of a broadcast.

**ON:**

This function is turned on.

**OFF:**

This function is turned off.

- The AUTO SHUTOFF function does not turn off the TV's main power.
- The AUTO SHUTOFF will not work for a VIDEO mode.

■ **VIDEO-3 SETTING**

Set the VIDEO-3 SETTING correctly according to the video signal input from the external device connected to the VIDEO-3 terminal. If this setting is incorrect, images will not be displayed.

**VIDEO:**

If a normal video signal (composite video signal) is input.

**COMPONENT:**

If a Component video signal (Y/CB/CR signals) is input.

- For detailed connecting methods, see "Additional preparation" on page 29. This Television is compatible with the Progressive video signal (525P signal) only when the component video signal is input.

## INSTALL menu

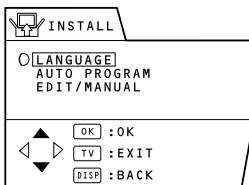

### ■ LANGUAGE

You can choose the language you want to use for the on-screen display from the language list in a menu.

- 1 Choose **LANGUAGE**, then press the **MENU/OK** button.



- 2 Press the **▼/▲** buttons to choose a language.

- 3 Press the **MENU/OK** button to complete the setting.

The menu disappears.

### ■ AUTO PROGRAM

You can automatically register the TV channels which can be received well at your residence in the TV's programme numbers by performing the following.

- 1 Choose **AUTO PROGRAM**, then press the **MENU/OK** button.

The AUTO PROGRAM function starts. The TV channels you receive are automatically stored in the programme numbers list.

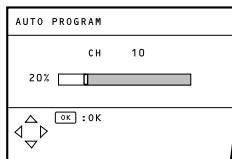

- To stop the AUTO PROGRAM function, press the **MENU/OK** button.

- 2 After the TV channels have been stored in the programme number list, the **EDIT** menu appears.

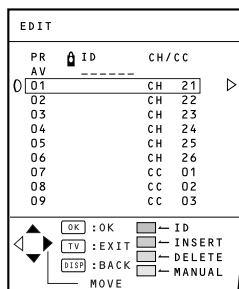

- You can proceed to edit the programme numbers list using the **EDIT/MANUAL** function. For details, see "EDIT/MANUAL" on page 25
- If a TV channel you want to view is not stored in the programme numbers list, you can register it using the **MANUAL** function. For details, see "EDIT/MANUAL" on page 25.
- The **AUTO PROGRAM** function does not store a TV channel to the programme number 0 (AV).
- If you do not need to use the **EDIT/MANUAL** function, press the **MENU/OK** button to exit the **EDIT** menu.



## ■ EDIT/MANUAL

The EDIT/MANUAL functions are divided into two types: editing of the current programme numbers (EDIT functions) and manual registration of a TV channel you want to view to the programme number (MANUAL function).

### CAUTION

- Using the MOVE, DELETE or INSERT function rewrites the current programme numbers list. Resultingly, the programme number of some of the TV channels will change.
  - When a TV channel which has been locked out using the CHANNEL GUARD function, using the MANUAL function for that TV channel cancels the CHANNEL GUARD function.
  - When a TV channel has already been registered in PR 99, using the INSERT function deletes the TV channel.
- 1 Choose EDIT/MANUAL, then press the MENU/OK button.**

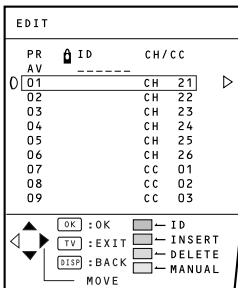

- 2 Follow the operation description of a function you want to use and operate the function.**

#### MOVE:

This function changes a programme number of a TV channel.

#### ID:

This function registers a Channel name (ID) to a TV channel.

#### INSERT:

This function adds a new TV channel in the current programme numbers list by using the CH/CC number.

#### DELETE:

This function deletes an unnecessary TV Channel.

#### MANUAL:

This function manually registers a new TV channel in a programme number.

- 3 Press the MENU/OK button to complete the setting.**

- For programme number PR 0, "AV" appears in the programme numbers list.

## FUNCTIONS

### MOVE

- Press the ▼/▲ buttons to choose a TV channel.
- Press the ► button to start the MOVE function.

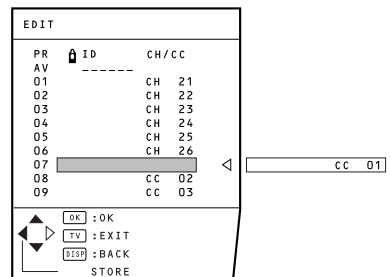

- 3 Press the ▼/▲ buttons to choose a new programme number.**

#### To cancel the MOVE function:

Press the DISPLAY button.

- 4 Press the ◀ button to change the programme number of a TV channel to a new programme number.**

## ID

- 1 Press the ▼/▲ buttons to choose a TV channel.
- 2 Press the red button to start the ID function.
- 3 Enter a channel name (ID). Press the ▼/▲ buttons to choose a character. Press the ◀/▶ buttons to move the cursor.

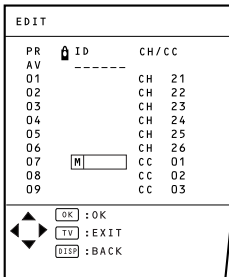

### To cancel the ID function:

Press the DISPLAY button.

- 4 Press the MENU/OK button to register a channel name to a TV channel.

## DELETE

- 1 Press the ▼/▲ buttons to choose a TV channel.
- 2 Press the yellow button to delete the TV channel.  
The TV channel is deleted from the programme numbers list.

## MANUAL

- 1 Press the ▼/▲ buttons to choose a programme number to which you want to register a new TV channel.
- 2 Press the blue button to activate the MANUAL function.  
At the right side following the CH/CC number, the SYSTEM (sound system) of the TV channel appears.

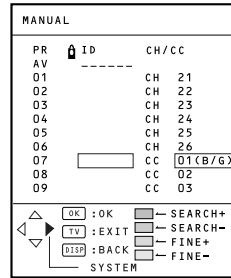

### To cancel the MANUAL function:

Press the DISPLAY button.

- 3 Press the ▶ button to choose the system (sound system) for a TV channel you want to register.
  - For the sound systems in each country or region, see the table "BROADCASTING SYSTEMS" on page 12.

- 4 Press the green or red button to search for a TV channel.

Scanning stops when the TV finds a TV channel. Then the TV channel is displayed.

- 5 Press the green or red button repeatedly until the TV channel you want appears.

### If the TV channel reception is poor:

Press the blue or yellow button to fine-tune the TV channel.

### If you cannot hear the normal sound even when the picture of the TV channel appears normally:

The SYSTEM setting is wrong. Press the ▶ button and choose a SYSTEM that has normal sound.

- 6 Press the MENU/OK button and register the TV channel to a programme number.

The normal EDIT menu is resumed.

## INSERT

### Preparation:

- Find the CH/CC number corresponding to the channel number of the TV channel from page 28.

### 1 Press the ▼/▲ buttons to choose a programme number for which you will register a new TV channel.

- When you attempt to insert the TV channel of NTSC-M system, press SOUND SYSTEM button to switch SOUND SYSTEM to M, then proceed to the next step.

### 2 Press the green button to start the INSERT function.

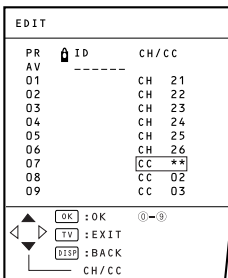

### 3 Press the ▼/▲ buttons to choose “CC” or “CH” according to the CH/CC number of the TV channel.

#### To cancel the INSERT function:

Press the DISPLAY button.

### 4 Press the Number buttons to enter the remaining CH/CC number.

The TV shifts to registration mode. When the registration is completed, the picture of the TV channel appears on the screen.

- The CH/CC number is a number indicating the broadcast frequency to the TV. If the TV cannot detect the TV channel corresponding to the broadcast frequency indicated by the CH/CC number, a picture in the no-signal state appears.

## Using the TV's menu

### CH/CC number

When you want to use the INSERT function on page 27, find the CH/CC number corresponding to the Channel number of the TV channel from this table.

US: The US channel numbers are the channel numbers used in the United States, Philippines, etc. CCIR: The CCIR channel numbers are the channel numbers used in the Middle East, Southeast Asia, etc. OIRT: The OIRT channel numbers are the channel numbers used in Eastern Europe, Russia, Vietnam, etc. AUSTRALIA: The AUSTRALIA channel numbers are the channel numbers used in Australia, etc.

Channel				
CH	US	CCIR	OIRT	AUSTRALIA
CH 02	US-2	E2	R1	AU-0
CH 03	US-3	E3		AU-1
CH 04	US-4	E4	R2	AU-2
CH 05	US-5	E5	R6	AU-6
CH 06	US-6	E6	R7	AU-7
CH 07	US-7	E7	R8	AU-8
CH 08	US-8	E8	R9	AU-9
CH 09	US-9	E9		
CH 10	US-10	E10	R10	AU-10
CH 11	US-11	E11	R11	AU-11
CH 12	US-12	E12	R12	
CH 13	US-13			
CH 14	US-14			
CH 15	US-15			
CH 16	US-16			
CH 17	US-17			
CH 18	US-18			
CH 19	US-19			
CH 20	US-20			
CH 21	US-21	E21		
CH 22	US-22	E22		
CH 23	US-23	E23		
CH 24	US-24	E24		
CH 25	US-25	E25		
CH 26	US-26	E26		
CH 27	US-27	E27		
CH 28	US-28	E28		
CH 29	US-29	E29		
CH 30	US-30	E30		
CH 31	US-31	E31		
CH 32	US-32	E32		
CH 33	US-33	E33		
CH 34	US-34	E34		
CH 35	US-35	E35		
CH 36	US-36	E36		
CH 37	US-37	E37		
CH 38	US-38	E38		
CH 39	US-39	E39		
CH 40	US-40	E40		
CH 41	US-41	E41		
CH 42	US-42	E42		
CH 43	US-43	E43		
CH 44	US-44	E44		
CH 45	US-45	E45		
CH 46	US-46	E46		
CH 47	US-47	E47		
CH 48	US-48	E48		
CH 49	US-49	E49		
CH 50	US-50	E50		
CH 51	US-51	E51		
CH 52	US-52	E52		
CH 53	US-53	E53		
CH 54	US-54	E54		
CH 55	US-55	E55		
CH 56	US-56	E56		
CH 57	US-57	E57		
CH 58	US-58	E58		
CH 59	US-59	E59		
CH 60	US-60	E60		
CH 61	US-61	E61		
CH 62	US-62	E62		
CH 63	US-63	E63		
CH 64	US-64	E64		
CH 65	US-65	E65		
CH 66	US-66	E66		
CH 67	US-67	E67		
CH 68	US-68	E68		
CH 69	US-69	E69		
CH 70				

Channel				
CC	US	CCIR	OIRT	AUSTRALIA
CC 01		S-1		AU-5
CC 02		S-2		
CC 03		S-3		
CC 04		S-4		
CC 05		S-5		
CC 06		S-6		AU-5A
CC 07		S-7		
CC 08		S-8		
CC 09		S-9		
CC 10		S-10		
CC 11		S-11		
CC 12		S-12		
CC 13		S-13		
CC 14	A	S-14		
CC 15	B	S-15		
CC 16	C	S-16		
CC 17	D	S-17		
CC 18	E	S-18		
CC 19	F	S-19		
CC 20	G	S-20		
CC 21	H	S-21		
CC 22	I	S-22		
CC 23	J	S-23		
CC 24	K	S-24		
CC 25	L	S-25		
CC 26	M	S-26		
CC 27	N	S-27		
CC 28	O	S-28		
CC 29	P	S-29		
CC 30	Q	S-30		
CC 31	R	S-31		
CC 32	S	S-32		
CC 33	T	S-33		
CC 34	U	S-34		
CC 35	V	S-35		
CC 36	W	S-36		
CC 37	W+1	S-37		
CC 38	W+2	S-38		
CC 39	W+3	S-39		
CC 40	W+4	S-40		
CC 41	W+5	S-41		
CC 42	W+6			
CC 43	W+7			
CC 44	W+8			
CC 45	W+9			
CC 46	W+10			
CC 47	W+11			
CC 48	W+12			
CC 49	W+13			
CC 50	W+14			
CC 51	W+15			
CC 52	W+16			
CC 53	W+17			
CC 54	W+18			
CC 55	W+19			
CC 56	W+20			
CC 57	W+21			
CC 58	W+22			
CC 59	W+23			
CC 60	W+24			
CC 61	W+25			
CC 62	W+26			
CC 63	W+27			
CC 64	W+28			
CC 75		X		
CC 76		Y	R3	
CC 77		Z	R4	AU-3
CC 78		Z+1	R5	
CC 79		Z+2		AU-4
CC 95	A-5			
CC 96	A-4			
CC 97	A-3			
CC 98	A-2			
CC 99	A-1			

# Additional preparation

## ■ Connecting the external devices

Connect the devices to the TV, paying attention to the following connection diagram.

### Before connecting anything:

- Read the manuals provided with the devices. Depending on the devices, the connection method may differ from the figure. In addition, the device settings may be changed depending on the connection method to secure proper operation.
- Turn off all the devices including the TV.
- The “Specifications” on page 34 contains the details of the VIDEO terminals. If you are connecting a device not listed in the following connection diagram, see the “Specifications” to choose the best VIDEO terminal.
- Note that connecting cables are not supplied.

- ① VCR (composite signal)
- ② VCR (S-VIDEO signal; Y/C)
- ③ VCR for recording (composite signal)
- ④ DVD player (composite signal)
- ⑤ DVD player (S-VIDEO signal; Y/C)
- ⑥ DVD player (component video signals; Y/CB/CR)
- ⑦ TV game (composite signal)
- ⑧ TV game (S-VIDEO signal; Y/C)
- ⑨ Camcorder (composite signal)
- ⑩ Camcorder (S-VIDEO signal; Y/C)
- ⑪ Headphones

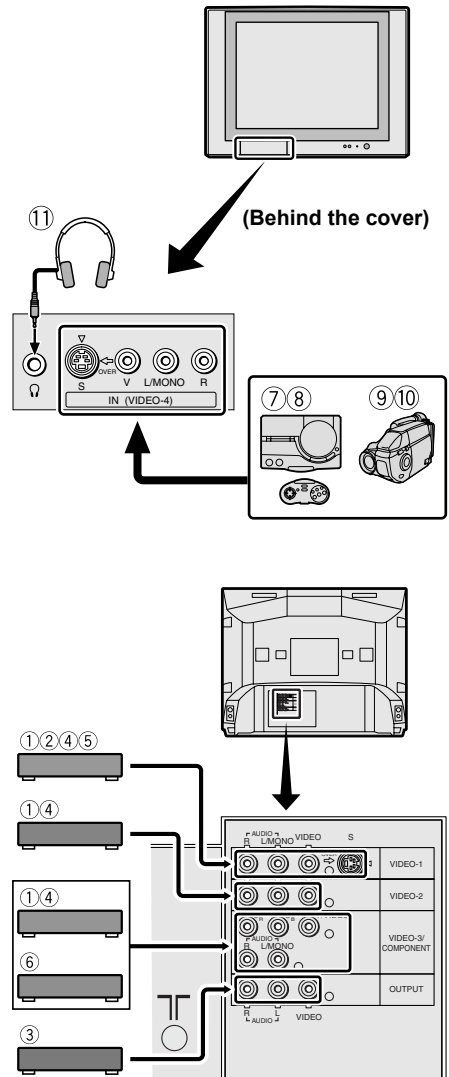

## Connecting methods

- 1 **Connect the TV's VIDEO jack and the device's VIDEO OUT (video output) jack with a video cable.**

### **If connecting a device to the TV with an S-VIDEO cable:**

Connect the VCR's S-VIDEO OUT (S-VIDEO output) connector and the TV's S connector with an S-VIDEO cable, instead of connecting with a video cable.

Note that the connection with a video cable will be ignored in case you connect a VCR to the TV with both video cable and S-VIDEO cable.

### **If connecting a DVD player to the TV with a component video cable.**

Connect three jacks (Y/VIDEO, CB and CR) in the VIDEO-3 terminal and the DVD player's COMPONENT (component video output) jacks with a component video cables, instead of connection with a video cable. Then set the VIDEO-3 SETTING to COMPONENT, according to "VIDEO-3 SETTING" on page 23.

- This Television is compatible with the Progressive video signal (525P signal) only when the component video signal is input.

If you have a DVD player that outputs Progressive video signals (525P) as a component video signal, then by attaching the device to the television with a component video cable you can see the actual images that are recorded on a DVD disc as an original image source.

**If connecting a device to the VIDEO-3/COMPONENT terminal with a video cable.** Connect the TV's Y/VIDEO jack and the device's VIDEO OUT (video output) jack with a video cable.

Then set the VIDEO-3 SETTING to VIDEO according to "VIDEO-3 SETTING" on page 23.

- In the VIDEO-4 terminal, the VIDEO jack is indicated by "V".

- 2 **Connect the TV's AUDIO jacks (L/MONO and R) and the device's AUDIO OUT (audio L/R output) jacks with an audio cable.**

**If the device's sound output is in mono:** Connect the device's AUDIO OUT jack and the TV's L/MONO jack with an audio cable.

## Connecting devices to the OUTPUT terminal

The signals of the images and sound you are currently viewing with this TV are output through the OUTPUT terminal. By connecting a VCR to the OUTPUT terminal, you can record the currently shown image and sound to that VCR. To do this, connect the VCR and OUTPUT terminal following the steps below.

- 1 **Connect the VIDEO jack in the OUTPUT terminal and the VCR's VIDEO IN (video input) jack with a video cable.**
- 2 **Connect the AUDIO jacks (L and R) in the OUTPUT terminal and the VCR's AUDIO IN (audio L/R input) jacks with an audio cable.**
  - When you turn off the TV, the signals from the OUTPUT terminal are also turned off.
  - The component signals input from the VIDEO-3/COMPONENT terminal cannot be output through the OUTPUT terminal.

## Connecting Headphones

Connect the headphones with a stereo mini jack (of 3.5 mm in diameter) to the Headphone jack at the TV front panel.

# Troubleshooting

---

If a problem arises while you are using the TV, please read this “Troubleshooting” well before you request having the TV repaired. You may be able to fix it easily by yourself. For example, if the AC plug is disconnected from the AC outlet, or the TV aerial has problems, you may think there is a problem with the TV itself.

## Important:

- This Troubleshooting guide only covers problems whose causes are not easy to determine. If a question arise when you are operating a function, read the page(s) corresponding to the operation of the function well, not this Troubleshooting guide.
- After you have followed the Troubleshooting description or the operating description of the functions concerned without any success, remove the AC plug from the AC outlet and request a repair of your TV. Do not attempt to repair the TV by yourself or remove the rear cover of the TV.

## ■ If you cannot turn on the TV

- Is the AC plug connected to the AC outlet?
- Is the POWER lamp lit? If not, press the Main power button.

## ■ No picture/No sound

- Have you chosen a TV channel whose reception is extremely bad? In this case, the BLUE BACK function will be activated, the entire screen becomes blue, and the sound is muted. In spite of this, if you want to view the TV channel, follow the description “BLUE BACK” on page 22 to try to change the BLUE BACK function setting to OFF.
- Are your SOUND SYSTEM settings for the TV channels correct? Follow the description “SOUND SYSTEM button” on page 11 to try to solve the trouble.

## ■ Poor picture

- If noise totally obscures the picture (snow), the aerial or aerial cable may have trouble. Check the following to try to solve the trouble:  
Has the TV and aerial been connected properly?  
Has the aerial cable been damaged?  
Is the aerial pointed to the right direction?  
Is the aerial itself faulty?

- If the TV or aerial receives interference from the other devices, stripes or noise may appear in the picture. Move such device as an amplifier, personal computer, or a hair drier that can cause interference away from your TV, or try changing its location. If the aerial suffers interference from a radio tower or high-voltage wire, please contact your local dealer.
- If the TV receives interferences from signal reflecting from mountains or building, double-pictures (ghosting) will occur.  
Try to change the aerial’s direction or replace the antenna with the one with better directionality.
- Are your COLOUR SYSTEM settings for the TV channels correct? Follow the description “COLOUR SYSTEM button” on page 11 to try to solve the trouble.
- Has COLOUR or BRIGHT been controlled properly? Follow the description “Adjusting the picture” on page 15 to try to adjust them properly.
- Videotaping teletext is not recommended because it may not record correctly.

- When a white and bright still image (such as a white dress) is displayed on the screen, the white part may look as if it were coloured.  
It is a phenomenon unavoidable due to the nature of the picture tube itself, and not due to a TV failure.  
When the picture disappears from the screen, the unnatural colours will also disappear.
- When viewing images from commercially available video software products, or videos from videotapes which have been recorded improperly, the top of the image may be distorted. This is due to the condition of the video signal, and not because of malfunction.

### ■ Poor sound

- Have you adjusted BASS or TREBLE properly? If not, follow the description "Adjusting the sound" on page 20 to try to adjust them properly.
- When the TV channel reception is poor, it can be hard to hear the stereo or bilingual sound. In this case, follow the description "STEREO / I•II" on page 20 to hear the sound more easily by changing it to a mono sound.

### ■ Operation disabled

- Have the batteries of the remote control become exhausted?  
Follow the description "Putting the batteries into the remote control" on page 4 and replace them with new batteries to try solve the problem.
- Have you attempted to use the remote control at the sides or rear of the TV or at a location more than seven meters apart from the TV location? Operate the remote control in the front of your TV or a location less than seven meters from your TV to try to solve the problem.

- Is the CHILD LOCK function set to ON? If the CHILD LOCK function is set to ON, you cannot operate the TV with the front control buttons of the TV. Follow the description "CHILD LOCK" on page 22 to try to set the CHILD LOCK function to OFF.
- If the TV operation becomes disabled suddenly, press the Main power button on the TV and turn off the main power. Try to press the Main power button again to turn on the main power. If the TV returns to a normal state, it is not a failure.
- The following function does not operate when receiving Progressive video signal (525P signal).  
MENU function:  
TINT and PULL DOWN

### ■ Other concerns

- When the AUTO SHUTOFF function operates, the TV is automatically turned off.  
If the TV is turned off suddenly, try to press the POWER button to turn on the TV once again. At this time, if the TV resumes a normal state, there is no problem.
- If you bring a magnetized device such as a speaker near to your TV, a picture may be warped or unnatural colours appear at the corners of the screen. In this case, keep the device apart from your TV. If the speaker causes such phenomena, use the magnetic-shielded speaker instead.



- A picture may be tilted due to the influence of the earth's magnetism. In this case, use the "PICTURE TILT" on page 18 to complete the tilt.
- It takes a short period of time from the time an operation such as changing channels is performed until an image is displayed. This is not a malfunction. This is the time required for the image to stabilize before it can be displayed.
- The TV may emit a crackling sound due to a sudden change in temperature. It does not matter if a picture or sound does not show any abnormality. If you hear crackling sounds frequently while you are viewing the TV, other causes may be assumed.

For precautionary purposes, request your service technician to inspect it.

- Touching the screen may cause you feel a slight electric shock due to its static electricity.

It is an unavoidable phenomenon due to the construction of the picture tube.

It is not a problem with the TV.

You can rest assured that this static discharge does not have harmful influence over the human body.

# Specifications

---

Broadcasting systems	B, G, I, D, K, K1, M
Colour systems	PAL, SECAM, NTSC3.58/4.43MHz
Channels and frequencies	VHF low channel (VL) =46.25 to 168.25 MHz VHF high channel (VH) =175.25 to 463.25 MHz UHF channel (U) =471.25 to 863.25 MHz • Receives cable channels in mid band (X to Z+2, S1 to S10), super band (S11 to S20) and hyper band (S21 to S41).
Sound-multiplex systems	A2 (B/G), NICAM (B/G, I, D/K) system
Power requirements	AC 110 to 240V, 50/60Hz
Audio output	Rated Power output: 10W + 10W
VIDEO-1 terminal	RCA connector × 3, S-VIDEO connector × 1 • Video input, S-VIDEO (Y/C) input and Audio L/R inputs are available.
VIDEO-2 terminal	RCA connector × 3 • Video input and Audio L/R inputs are available.
VIDEO-3/COMPONENT	RCA connector × 5 terminal • Video input/Component video (Y/CB/CR) input and Audio L/R inputs are available. • Progressive video signal (525P signal) input is available.
VIDEO-4 terminal	RCA connector × 3, S-VIDEO connector × 1 • Video input, S-VIDEO (Y/C) input and Audio L/R inputs are available.
OUTPUT terminal	RCA connector × 3 • Video output and Audio L/R outputs are available.
Headphone jack	Stereo mini-jack (3.5 mm in diameter)
Accessories	Remote control unit × 1 (RM-C1352) AA/R6 dry cell battery × 2
Speakers	HV-29WH11: (13cm × 6.5cm) × 2

## Design and specifications subject to change without notice.

Pictures displayed on the screen using this TV's ZOOM functions should not be shown for any commercial or demonstration purpose in public places (cafes, hotels, etc.) without the consent of the owners of copyright of the original picture sources, as this constitutes an infringement of copyright.

**This TV does not conform to the PAL-D Chinese broadcasting system.**

*此种电视机不适用于PAL-D中国广播制式。*

## Free Manuals Download Website

<http://myh66.com>

<http://usermanuals.us>

<http://www.somanuals.com>

<http://www.4manuals.cc>

<http://www.manual-lib.com>

<http://www.404manual.com>

<http://www.luxmanual.com>

<http://aubethermostatmanual.com>

Golf course search by state

<http://golfingnear.com>

Email search by domain

<http://emailbydomain.com>

Auto manuals search

<http://auto.somanuals.com>

TV manuals search

<http://tv.somanuals.com>