

JVC

ENGLISH

ESPAÑOL

FRANÇAIS

KD-R618 / KD-A615 / KD-R610

CD RECEIVER / RECEPTOR CON CD /
RÉCEPTEUR CD

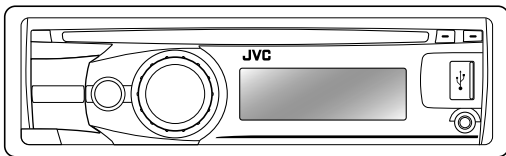
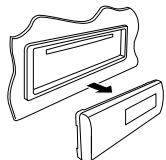

**MP3
WMA**



For canceling the display demonstration, see page 4. / Para cancelar la demostración en pantalla, consulte la página 4. / Pour annuler la démonstration des affichages, référez-vous à la page 4.

For installation and connections, refer to the separate manual.
Para la instalación y las conexiones, refiérase al manual separado.
Pour l'installation et les raccordements, se référer au manuel séparé.

For customer Use:

Enter below the Model No. and Serial No. which are located on the top or bottom of the cabinet. Retain this information for future reference.

Model No. _____

Serial No. _____

INSTRUCTIONS

MANUAL DE INSTRUCCIONES
MANUEL D'INSTRUCTIONS

GET0638-001A

[J]

INFORMATION (For U.S.A.)

This equipment has been tested and found to comply with the limits for a Class B digital device, pursuant to Part 15 of the FCC Rules. These limits are designed to provide reasonable protection against harmful interference in a residential installation. This equipment generates, uses, and can radiate radio frequency energy and, if not installed and used in accordance with the instructions, may cause harmful interference to radio communications. However, there is no guarantee that interference will not occur in a particular installation. If this equipment does cause harmful interference to radio or television reception, which can be determined by turning the equipment off and on, the user is encouraged to try to correct the interference by one or more of the following measures:

- Reorient or relocate the receiving antenna.
- Increase the separation between the equipment and receiver.
- Connect the equipment into an outlet on a circuit different from that to which the receiver is connected.
- Consult the dealer or an experienced radio/TV technician for help.

Caution:

Changes or modifications not approved by JVC could void the user's authority to operate the equipment.

IMPORTANT FOR LASER PRODUCTS

1. CLASS 1 LASER PRODUCT

2. CAUTION: Do not open the top cover. There are no user serviceable parts inside the unit; leave all servicing to qualified service personnel.

3. CAUTION: (For U.S.A.) Visible and/or invisible class II laser radiation when open. Do not stare into beam.

(For Canada) Visible and/or invisible class 1M laser radiation when open. Do not view directly with optical instruments.

4. REPRODUCTION OF LABEL: CAUTION LABEL, PLACED OUTSIDE THE UNIT.

CAUTION VISIBLE AND/OR INVISIBLE CLASS 1M LASER RADIATION WHEN OPEN. DO NOT VIEW DIRECTLY WITH OPTICAL INSTRUMENTS. IEC60825-1:2001 (ENG)	ATTENTION RAYONNEMENT LASER VISIBLE ET/OU INVISIBLE DE CLASSE 1M UNE FOIS OUVERT. NE PAS REGARDER DIRECTEMENT AVEC DES INSTRUMENTS OPTIQUES. (FRA)	AVISO RADIACION LASER DE CLASE 1M VISIBLE Y/O INVISIBLE CUANDO ESTA ABIERTO. NO MIRAR DIRECTAMENTE CON INSTRUMENTAL OPTICO. (ESP)	VARNING SYNLIG OCH/ELLER OSYNLIG LASERSTRÅLNING, KLASS 1M, NÄR DENNA DEL ÄR ÖPPNAD. BETRÄKTA EJ STRÅLEN MED OPTISKA INSTRUMENT. (SWE)	注意 こゝを開くと可視 及び不可視の有害 のクラス1M レーザー放射が 出ます。 光学機器で直接 見ないでください。 (JPN)	CAUTION VISIBLE AND/OR INVISIBLE CLASS II LASER RADIATION WHEN OPEN. DO NOT STARE INTO BEAM. FDA 21 CFR (ENG)
--	---	--	--	---	--



[European Union only]

Warning:

If you need to operate the unit while driving, be sure to look around carefully or you may be involved in a traffic accident.

For safety...

- Do not raise the volume level too much, as this will block outside sounds, making driving dangerous.
- Stop the car before performing any complicated operations.

Temperature inside the car...

If you have parked the car for a long time in hot or cold weather, wait until the temperature in the car becomes normal before operating the unit.

How to read this manual

The following icons/symbols are used to indicate:

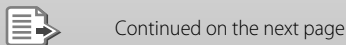
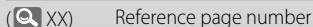
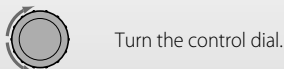
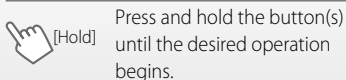

How to attach/detach the control panel

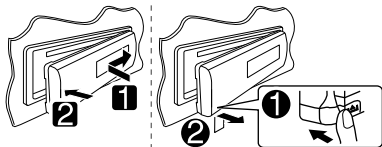

How to reset your unit

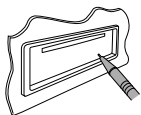

Your preset adjustments will also be erased (except the registered Bluetooth device). (🔍 11)

How to forcibly eject a disc

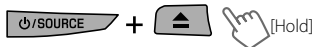

- You can forcibly eject the loaded disc even if the disc is locked. To lock/unlock the disc, 🔍 9.
- Be careful not to drop the disc when it ejects.
- If this does not work, reset your unit.

Thank you for purchasing a JVC product. Please read all instructions carefully before operation, to ensure your complete understanding and to obtain the best possible performance from the unit.

CONTENTS

- 3 How to read this manual
- 3 How to attach/detach the control panel
- 3 How to reset your unit
- 3 How to forcibly eject a disc
- 4 **Canceling the display demonstration**
- 4 **Setting the clock**
- 5 **Preparing the remote controller (RM-RK50)**
- 6 **Basic operations**
- 7 **Listening to the radio**
- 9 **Listening to a disc**
- 10 **Listening to the USB device**
- 11 **Using Bluetooth® devices**
 - 13 Using a Bluetooth mobile phone
 - 14 Using a Bluetooth audio player
- 16 **Listening to the HD Radio™ Broadcast**
- 18 **Listening to the satellite radio**
- 20 **Listening to the iPod/iPhone**
- 22 **Listening to the other external components**
- 23 **Selecting a preset sound mode**
- 24 **Menu operations**
- 31 **More about this unit**
- 35 **Maintenance**
- 36 **Troubleshooting**
- 42 **Specifications**

Canceling the display demonstration

1 Turn on the power.



2 MENU [Hold]



3



4 Select <DEMO OFF>.



5



6 Finish the procedure.



Setting the clock

1 Turn on the power.



2 MENU [Hold]



3 Select <CLOCK>.



4 Select <CLOCK SET>.



5 Adjust the hour.



6 Adjust the minute.



7 Finish the procedure.



Preparing the remote controller (RM-RK50)

When you use the remote controller for the first time, pull out the insulation sheet.

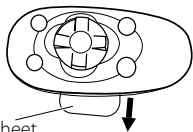

Insulation sheet

For USA-California Only:

This product contains a CR Coin Cell Lithium Battery which contains Perchlorate Material—special handling may apply.

See www.dtsc.ca.gov/hazardouswaste/perchlorate

If the effectiveness of the remote controller decreases, replace the battery.

Replacing the lithium coin battery

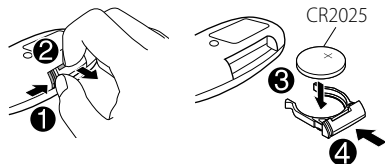

Caution:

- Danger of explosion if battery is incorrectly replaced. Replace only with the same or equivalent type.
- Battery shall not be exposed to excessive heat such as sunshine, fire, or the like.

Warning (to prevent accidents and damage):

- Do not install any battery other than CR2025 or its equivalent.
- Do not leave the remote controller in a place (such as dashboards) exposed to direct sunlight for a long time.
- Store the battery in a place where children cannot reach.
- Do not recharge, short, disassemble, heat the battery, or dispose of it in a fire.
- Do not leave the battery with other metallic materials.
- Do not poke the battery with tweezers or similar tools.
- Wrap the battery with tape and insulate when throwing away or saving it.







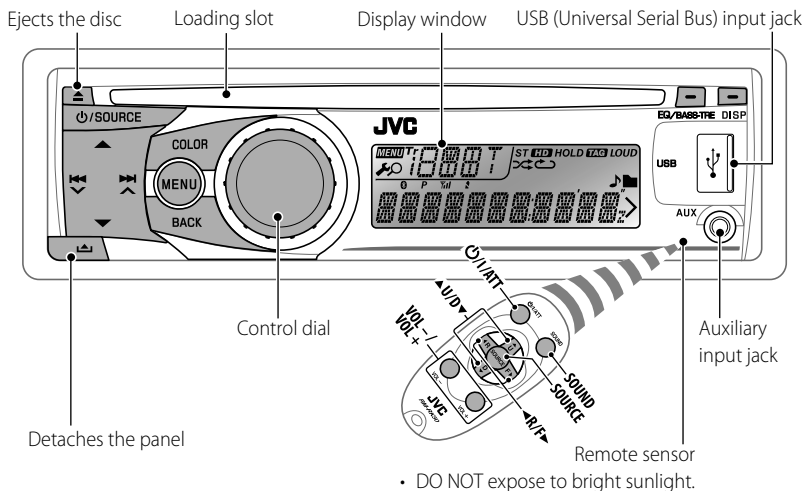

KD-R618/KD-A615 is equipped with the steering wheel remote control function. Before operating, connect an exclusive remote adapter (not supplied) which matches your car to the steering wheel remote input terminal on the rear of the unit.



- For details, refer also to the instructions supplied with the remote adapter.

Basic operations





When you press or hold the following button(s)...

Main unit	Remote controller	General operation
		Turns on. • When the power is on, pressing Power/ATT on the remote controller also mutes the sound or pauses. Press Power/ATT again to cancel muting or resume playback. Turns off if pressed and held.
		Selects the available sources (if the power is turned on). • If the source is ready, playback also starts.
		Adjusts the volume level.
		Selects items. • Mutes the sound while listening to a source. If the source is "CD," "USB" or "USB-IPOD," playback pauses. Press the control dial again to cancel muting or resume playback. • Confirms selection.
		Selects the sound mode. • Enters tone level adjustment directly (🔊 23) if pressed and held EQ/BASS-TRE on the main unit.

Main unit	Remote controller	General operation
	—	<ul style="list-style-type: none"> Enters <COLOR> setting directly (🔍 29). Enters <COLOR SETUP> setting directly (🔍 30) if pressed and held.
	—	Returns to the previous menu.
	—	Power off : Checks the current clock time. Power on : Changes the display information.

Listening to the radio

1  → "FM" or "AM"

2  "ST" lights up when receiving an FM stereo broadcast with sufficient signal strength.

Manual search

 "M" flashes, then press the button repeatedly.
[Hold]

When an FM stereo broadcast is hard to receive

1  [Hold]

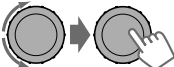
2  ⇒ <TUNER> ⇒ <MONO> ⇒ <MONO ON>
Reception improves, but stereo effect will be lost.

To restore the stereo effect, repeat the same procedure to select <MONO OFF>.

Automatic presetting (FM)—

SSM (Strong-station Sequential Memory)

You can preset up to 18 stations for FM.

While listening to a station...

1  [Hold]

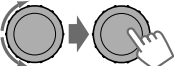
2  ⇒ <TUNER> ⇒ <SSM> ⇒ <SSM 01 – 06> / <SSM 07 – 12> / <SSM 13 – 18>
"SSM" flashes and local stations with the strongest signals are searched and stored automatically.

To preset another 6 stations, repeat the above procedure by selecting one of the other 6 SSM setting ranges.

If an HD Radio tuner box is connected (🔍 16), you can also search and store 6 stations for AM by following the above operations.



Manual presetting (FM/AM)

You can preset up to 18 stations for FM and 6 stations for AM.

Ex: Storing FM station of 92.50 MHz into preset number "04."

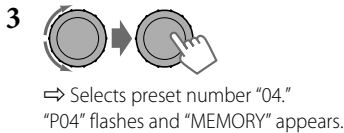

Selecting a preset station

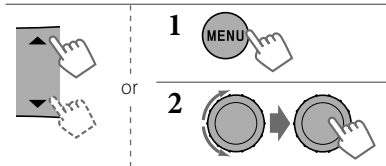

Changing the display information

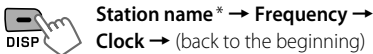

* If no title is assigned to a station, "NO NAME" appears for a few seconds.

Using the remote controller

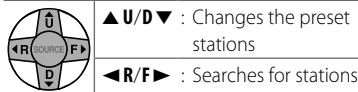

Title assignment

You can assign titles up to 30 station frequencies (FM and AM) using 8 characters (maximum) for each title.

- If you try to assign titles to more than 30 station frequencies, "NAME FULL" appears. Delete unwanted titles before assignment.
- When HD Radio tuner box is connected (📶 16), this feature will be disabled.

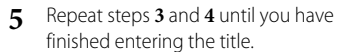
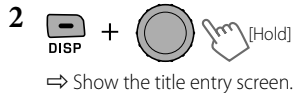

To erase the entire title, press and hold **DISP** after step 2, then press the control dial.

Available characters

A	B	C	D	E	F	G	H	I	
J	K	L	M	N	O	P	Q	R	
S	T	U	V	W	X	Y	Z	0	
1	2	3	4	5	6	7	8	9	
—	/	<	>	Space					

Listening to a disc

1



⇒ Turn on the power.

2



All tracks will be played repeatedly until you change the source or eject the disc.

Stopping playback and ejecting the disc



"NO DISC" appears.

Press **⏻**/SOURCE to listen to another playback source.

Prohibiting disc ejection



To cancel the prohibition, repeat the same procedure.

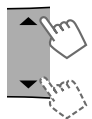

Selects folder of the MP3/WMA



Selects track



Fast-forwards or reverses the track

Selecting a track/folder

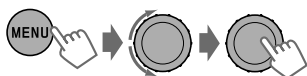

For MP3/WMA discs, select the desired folder, then the desired track by repeating the control dial procedures.

- If the MP3/WMA disc contains many tracks, you can fast search (± 10 , ± 100 , ± 1000) through the disc by turning the control dial quickly.
- To return to the previous menu, press **BACK**.

Caution on volume setting:

Discs produce very little noise compared with other sources. Lower the volume before playing a disc to avoid damaging the speakers by the sudden increase of the output level.

Selecting the playback modes

You can use only one of the following playback modes at a time.

1



2

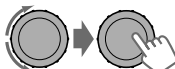

⇒ "REPEAT" ↔ "RANDOM"

3

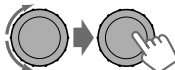

REPEAT

TRACK RPT : Repeats current track

FOLDER RPT : Repeats current folder

RANDOM

FOLDER RND: Randomly plays all tracks of current folder, then tracks of next folders

ALL RND : Randomly plays all tracks

To cancel repeat play or random play, select "RPT OFF" or "RND OFF."



Changing the display information



Disc title/Album name/performer (folder name)* → Track title (file name)* → Current track number with the elapsed playing time → Current track number with the clock time → (back to the beginning)

* If the current disc is an audio CD, "NO NAME" appears.

If an MP3/WMA file does not have Tag information or <TAG DISPLAY> is set to <TAG OFF> (🔍 25), folder name and file name appear.

Using the remote controller



▲ U/D ▼ : Selects folder of the MP3/WMA

◀ R/F ▶ : Selects track

◀ R/F ▶ : Fast-forwards or [Hold] reverses the track

Listening to the USB device

This unit can play MP3/WMA files stored on a USB mass storage class device.

You can connect a USB mass storage class device such as a USB memory, Digital Audio Player, etc. to the unit.

- You can also connect an Apple iPod/iPhone to the USB input jack. For details of the operations, 🔍 20 – 21.

1



⇒ Turn on the power.

2

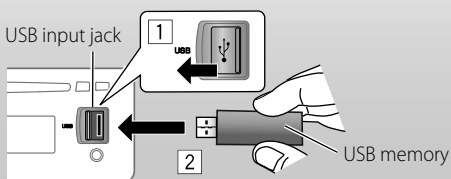

All tracks will be played repeatedly until you change the source or detach the USB device.

Caution on volume setting:

USB devices produce very little noise compared with other sources. Lower the volume before playing a USB to avoid damaging the speakers by sudden increase of the output level.

If you have turned off the power (without detaching the USB device)...

Pressing **🔌/SOURCE** turns on the power and playback starts from where it has been stopped previously.

- If a different USB device is currently attached, playback starts from the beginning.

Stop playing and detaching the USB device

Straightly pull it out from the unit. "NO USB" appears. Press **🔌/SOURCE** to listen to another playback source.

You can operate the USB device in the same way you operate the files on a disc. (🔍 9)

Cautions:

- Avoid using the USB device if it might hinder your safety driving.
- Do not pull out and attach the USB device repeatedly while "READING" is shown on the display.
- Do not start the car engine if a USB device is connected.
- This unit may not be able to play the files depending on the type of USB device.
- Operation and power supply may not work as intended for some USB devices.

- You cannot connect a computer to the USB input terminal of the unit.
- Make sure all important data has been backed up to avoid losing the data.
- Do not leave a USB device in the car, expose to direct sunlight, or high temperature to avoid deformation or cause damages to the device.
- Some USB devices may not work immediately after attaching USB device or turn on the power.
- For more details about USB operations,  32, 33.

Using Bluetooth® devices

For Bluetooth operations, it is required to connect the Bluetooth adapter, KS-BTA200 (not supplied) to the expansion port on the rear of this unit.

- Refer to pages **i** and **ii** at the end of the manual to check the countries where you may use the Bluetooth® function.
- For details, refer also to the instructions supplied with the Bluetooth adapter and the Bluetooth device.

To use a Bluetooth device through the unit ("BT-PHONE" and "BT-AUDIO") for the first time, you need to establish a Bluetooth wireless connection between the unit and the device.

- Once the connection is established, it is registered on the unit even if you reset your unit. Up to five devices can be registered in total.
- Only one device can be connected at a time for each source ("BT-PHONE" and "BT-AUDIO").

Registration (Pairing) methods

Use either of the following items ("OPEN" or "SEARCH") in the Bluetooth menu to register and make the unit ready to establish a new Bluetooth connection with a device.

"OPEN" : Connection is established by operating the Bluetooth device.

"SEARCH" : Connection is established by operating the unit.

Registering using "OPEN"

Preparation: Operate the device to turn on its Bluetooth function.



⇒ "BT-PHONE" or "BT-AUDIO"



⇒ "NEW DEVICE" ⇒ "OPEN"



⇒ Enter a PIN (Personal Identification Number) code in to the unit.

You can enter any number you like (1-digit to 16-digit number).

[Initial: 0000]

- Some devices have their own PIN code. Enter the specified PIN code in to the unit.



4 Repeat step 3 on page 11 until you have finished entering the PIN code.



"OPEN.." flashes.

6 Use the Bluetooth device to search and connect.

On the device to be connected, enter the same PIN code you have just entered for this unit. "CONNECTED" appears.

Now connection is established and you can use the device through the unit.

The device remains registered even after you disconnect the device. Use "CONNECT" (or activate "AUTO CNNECT") to connect the same device from next time on. (🔍 15)

Registering using ("SEARCH"/"SPECIAL")



⇒ "BT-PHONE" or "BT-AUDIO"



⇒ "NEW DEVICE"



⇒ "SEARCH" : To search for available devices

The unit searches and displays the list of the available devices. "UNFOUND" appears if no available device is detected.

----- or -----

⇒ "SPECIAL" : To connect a special device

The unit displays the list of the preset devices.



⇒ Select a device you want to connect.

5 **For available devices...**

⇒ Enter the specific PIN code of the device to the unit.

- Refer to the instructions supplied with the device to check the PIN code. Use the Bluetooth device to connect. Now connection is established and you can use the device through the unit.

For special device...

Use "OPEN" or "SEARCH" to connect.

Connecting/disconnecting/ deleting a registered device



⇒ "BT-PHONE" or "BT-AUDIO"



⇒ Select a device you want to connect/disconnect/delete.



⇒ "CONNECT" or "DISCONNECT" : To connect/disconnect the selected device

----- or -----

⇒ "DELETE" ⇒ "YES" : To delete the selected device

You can set the unit to connect the Bluetooth device automatically when the unit is turned on. ("AUTO CNNECT," 🔍 15)

Using a Bluetooth mobile phone

- 
⇒ "BT-PHONE"
- 
⇒ Bluetooth menu
- Make a call or setting using the Bluetooth setting menu.**
(🔍 15)

When a call comes in....

The source is automatically changed to "BT-PHONE."

- The display will flash in blue. (<RING COLOR>, 📺 26)

When "AUTO ANSWER" is activated....

The unit answers the incoming calls automatically. (🔍 15)

- When "AUTO ANSWER" is deactivated, press any button (except ϕ /SOURCE / \blacktriangle / \blacktriangle) to answer the incoming call.
- You can adjust the microphone volume level. (🔍 15)

To end the call

Hold any button (except ϕ /SOURCE / \blacktriangle / \blacktriangle).

When a text message comes in....

If the mobile phone is compatible with text message (notified through JVC Bluetooth adapter) and "MSG INFO" (message info) is set to "AUTOMATIC" (🔍 15), the unit rings to inform you of the message arrival.





- "RCV MESSAGE" (receiving message) appears and the display illuminate in blue. (<RING COLOR>, 📺 26)

Using the remote controller

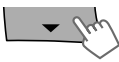

-
- \blacktriangle U/D \blacktriangledown / : Answers calls
 - \blacktriangleleft R/F \blacktriangleright /
SOURCE
-
- \blacktriangle U/D \blacktriangledown / : Rejects calls
 - \blacktriangleleft R/F \blacktriangleright /
SOURCE
[Hold]
-

Making a call

- 
⇒ "BT-PHONE"
- 
-  → 
⇒ Select "DIAL" menu.
-  → 

⇒ Select a calling method.

PHONE BOOK* \leftrightarrow MISSED* \leftrightarrow

NUMBER \leftrightarrow VOICE DIAL \leftrightarrow

REDIAL* \leftrightarrow RECEIVED* \leftrightarrow (back to the beginning)

* Displays only when your mobile phone is equipped with these functions and is compatible with this unit.



5 For REDIAL, RECEIVED, MISSED

⇒ Repeat step 4 on page 13 to select a name (if it is acquired) or a phone number.

For PHONE BOOK

⇒ Repeat step 4 on page 13 to select a name or a phone number.

For NUMBER



⇒ Enter a phone number.



⇒ Confirm.

For VOICE DIAL

⇒ Speak the name you want to call when "SAY NAME" appears.

- If your mobile phone does not support the voice recognition system, "ERROR" appears.
- Using voice tags may be difficult in a noisy environment or during an emergency.

• To return to the previous menu, press ▲.

Using a Bluetooth audio player



⇒ "BT-AUDIO"

If playback does not start, operate the Bluetooth audio player to start playback. Operate the Bluetooth audio player to pause (if playback does not pause when you change the source).



Reverse skips/forward skips



Pauses/starts playback*
* Operation may be different according to the connected Bluetooth audio player.



Enter setting menu (Device list)

For connecting/disconnecting/deleting a registered device, see 12.

Using the remote controller



◀R/F▶ : Reverse skips/forward skips

Changing the Bluetooth settings



⇒ "BT-PHONE" or "BT-AUDIO"



⇒ Bluetooth menu



⇒ "SETTINGS"



⇒ Select a setting item.

AUTO CNNECT ↔ **AUTO ANSWER***1

↔ **MSG INFO***2 ↔ **MIC SETTING***1

↔ **VERSION***3 ↔ (back to the beginning)



⇒ Change the setting accordingly. For setting menu, right column.

*1 Appears only when a Bluetooth phone is connected.

*2 Appears only when a Bluetooth phone is connected and it is compatible with text message (notified through JVC Bluetooth adapter).

*3 Bluetooth Audio: Shows only "Version."

Setting menu [Initial: Underlined]

AUTO CNNECT (connect)

When the unit is turned on, the connection is established automatically with...

OFF: No Bluetooth device.

LAST: The last connected Bluetooth device.

ORDER: The available registered Bluetooth device found at first.

AUTO ANSWER

Only for the device being connected for "BT-PHONE."

ON: The unit answers the incoming calls automatically.

OFF: The unit does not answer the calls automatically. Answer the calls manually.

REJECT: The unit rejects all incoming calls.

MSG INFO (message info)

Only for the device being connected for "BT-PHONE."

AUTOMATIC: The unit informs you of the arrival of a message by ringing and displaying "RCV MESSAGE" (receiving message).

- The display illuminate in blue. (<RING COLOR>, 26)

MANUAL: The unit does not inform you of the arrival of a message.

MIC SETTING (microphone setting)

Only for the device being connected for "BT-PHONE." Adjust microphone volume connected to the Bluetooth adapter, [**LEVEL 01/02/03**].

VERSION

The Bluetooth software and hardware versions are shown.



Warning messages

ERROR CNNCT (Error Connection)

The device is registered but the connection has failed. Use "CONNECT" to connect the device again. (🔍 12)

ERROR

Try the operation again. If "ERROR" appears again, check if the device supports the function you have tried.

UNFOUND

No available Bluetooth device is detected by "SEARCH."

LOADING*

The unit is updating the phone book.

PLEASE WAIT

The unit is preparing to use the Bluetooth function. If the message does not disappear, turn off and turn on the unit, then connect the device again (or reset the unit).

RESET 8

Check the connection between the adapter and this unit.

**Displays only when your mobile phone is equipped with these functions and is compatible with this unit.*

Bluetooth Information:

If you wish to receive more information about Bluetooth, visit the following JVC web site:
<<http://www.jvc.co.jp/english/car/>> (English website only)

Listening to the HD Radio™ Broadcast

Before operating, connect HD Radio tuner box, KT-HD300 (not supplied) to the expansion port on the rear of the unit.

- For details, refer also to the instructions supplied with the HD Radio tuner box.

What is HD Radio Technology?

HD Radio Technology can deliver high-quality digital sound—AM digital will have FM-like quality (in stereo) and FM digital will have CD-like quality—with static-free and clear reception. Furthermore, stations can offer text and data, such as artist names and song titles.

- When the HD Radio tuner box is connected, it can also receive conventional analog broadcasts.
- Many HD Radio stations also offer more than one channel of programming. This service is called multicasting.
- To find HD Radio stations in your area, visit <<http://www.hdradio.com/>>.

For basic radio operations, 🔍 7, 8.

When receiving...

An HD Radio station

Lights up when digital audio is broadcast

Flashes when analog audio is broadcast



Station Call Sign appears.

HD Radio multicast channels



Channel number

First four letters of Call Sign



Select your desired channel.

HD1 ↔ **HD2** ↔ ... ↔ **HD8**

↔ (back to the beginning)

"LINKING" appears while linking to a multicast channel.

Searching for HD Radio stations only

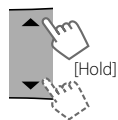

"HD" flashes.

Changing HD Radio reception mode

While receiving an HD Radio broadcast, the unit receives digital or analog audio automatically due to the receiving condition.

While listening to an HD Radio station...

1  [Hold]

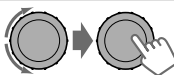
2 

⇨ <TUNER> ⇨ <BLEND HOLD> ⇨
<AUTO> / <DIGITAL> / <ANALOG>

"HD" lights up when holding the digital reception or flashes when holding the analog reception.

- If no sound can be heard with <AUTO>, change the setting to <ANALOG> or <DIGITAL>.
- The setting automatically changes to <AUTO> if you tune in to or change to another station, or if you turn off the power.
- This setting cannot take effect for the conventional FM/AM stations.
- If the radio station forces the reception mode to digital, the HOLD indicator flashes.

Changing the display information



Call Sign*1 → **Frequency** →
Title/artist/album name of the current segment*2 → **Clock** →
(back to the beginning)

*1 "****-FM" or "*****" appears when no Call Sign is received.

*2 "NO TEXT" appears when no text is received.

Using the remote controller



▲ **U/D** ▼ : Changes the preset stations

◀ **R/F** ▶ : Searches for stations

Listening to the satellite radio

Before operating, connect either one of the following systems (not supplied) to the expansion port on the rear of this unit.

For listening to a SIRIUS Satellite radio:

- SC-C1 and KS-SRA100
- PnP, SC-VDOC1 and KS-SRA100

For listening to an XM Satellite radio:

- JVC Smart Digital Adapter (XMDJVC100)
- CNP2000UC and CNPJVC1

- For details, refer also to the instructions supplied with the other components.

GCI (Global Control Information) update

- If channels are updated after subscription, updating starts automatically. "UPDATING" flashes and no sound can be heard.
- Update takes a few minutes to complete.
- During update, you cannot operate your satellite radio.



⇒ "SIRIUS" or "XM"



⇒ Select a category.

SIRIUS: If you select "ALL," you can tune in to all the channels of all categories.



⇒ Select a channel to listen.

Holding the button changes the channels rapidly.

While searching, invalid and unsubscribed channels are skipped.

XM: If you do not select a channel within 15 seconds, category selected in step ② is canceled. You can select all channels of all categories now (including non-categorised channels).

Activate your SIRIUS subscription after connection



⇒ "SIRIUS"

SIRIUS Satellite radio starts updating all the SIRIUS channels. Once completed, SIRIUS Satellite radio tunes in to the preset channel, CH184.

2 Check your SIRIUS ID. (📞 25)

3 Contact SIRIUS on the internet at <<http://activate.siriusradio.com/>> to activate your subscription, or you can call SIRIUS toll-free at 1-888-539-SIRIUS (7474).

- "SUB UPDT PRESS ANY KEY" scrolls on the display once subscription has been completed.

Activate your XM subscription after connection

• Only Channel 0, 1, and 247 are available before activation.



⇒ "XM"

XMDirect™ Tuner Box or XMDirect2 Tuner System starts updating all the XM channels. "Channel 1" is tuned in automatically.

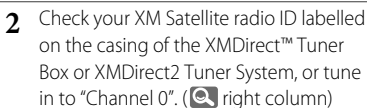

3 Contact XM Satellite radio on the internet at <<http://xmradio.com/activation/>> to activate your subscription, or you can call 1-800-XM-RADIO (1-800-967-2346).

• Once completed, the unit tunes in to one of the available channels (Channel 4 or higher).

Storing channels in memory

You can preset up to 18 channels for both SIRIUS and XM.

Ex.: Storing channel into preset number "04."

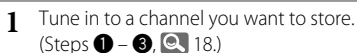

(Steps 1 – 3, 18.)



"PRESET MODE" flashes.

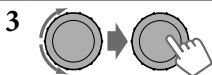

⇒ Select preset number "04."
"P04" flashes.

Selecting SIRIUS/XM preset station

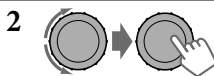

Checking the satellite radio ID

While selecting "SIRIUS" or "XM"...



⇒ Select "Channel 0."

SIRIUS: SIRIUS identification number is displayed after "Channel 0" is selected.

XM: The display alternately shows "RADIO ID" and the 8-digit (alphanumeric) ID number.

To cancel the ID number display, select any channel other than "Channel 0."

Changing the display information



Category name → Channel name
→ Artist name → Composer
name* → Song/program name/
title → Clock → (back to the
beginning)

* Only for SIRIUS Satellite radio.

Using the remote controller

	▲ U/D ▼ : Changes the categories
	◀ R/F ▶ : Changes the channels
	◀ R/F ▶ : Changes the channels rapidly [Hold]

Listening to the iPod/iPhone

You can connect the iPod/iPhone using the USB 2.0 cable (accessory of the iPod/iPhone) to the USB input jack on the control panel.

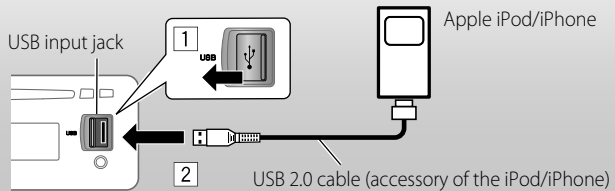

- Disconnecting the iPod/iPhone will stop playback. Press **⏪/SOURCE** to listen to another playback source.
- For details, refer also to the instructions supplied with your iPod/iPhone.

Caution:

- Avoid using the iPod/iPhone if it might hinder your safety while driving.
- Make sure all important data has been backed up to avoid losing the data.



There are two control terminals:

- <HEAD MODE> Control by this unit.
- <IPOD MODE> Control by the connected iPod/iPhone.

Preparation: Select the controlling terminal, <HEAD MODE> or <IPOD MODE> for iPod playback:

- Press and hold **BACK** button.
- Make the selection from <IPOD SWITCH> setting,  28.

The operations explained below are under <HEAD MODE>.

- 
⇒ "USB-IPOD"
Playback starts automatically.
- 
⇒ Select a song.



Pauses or resumes playback



Selects track



Fast-forwards or reverses the track

Selecting a track from the menu

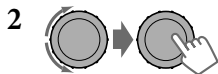

⇒ Select the desired menu.

PLAYLISTS ↔ **ARTISTS** ↔ **ALBUMS**

↔ **SONGS** ↔ **PODCASTS** ↔

GENRES ↔ **COMPOSERS** ↔

AUDIOBOOKS ↔ (back to the beginning)

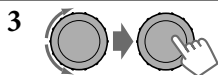

⇒ Select the desired track.

Repeat this procedure until the desired track is selected.

- If the selected menu contains many tracks, you can fast search (± 10 , ± 100 , ± 1000) through the menu by turning the control dial quickly.
- To return to the previous menu, press **BACK**.

Selecting the playback modes

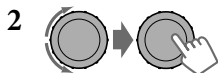

⇒ "REPEAT" ↔ "RANDOM"

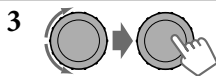

REPEAT

ONE RPT : Functions the same as "Repeat One" of the iPod

ALL RPT : Functions the same as "Repeat All" of the iPod

RANDOM

ALBUM RND : Functions the same as "Shuffle Albums" of the iPod

SONG RND : Functions the same as "Shuffle Songs" of the iPod

- To cancel repeat play or random play, select "RPT OFF" or "RND OFF."
- "ALBUM RND" is not available for some iPod.
- To return to the previous menu, press **BACK**.

Changing the display information



Album name/performer → **Track title** →
Current track number with the elapsed playing time → **Current track number with the clock time** → (back to the beginning)

Using the remote controller

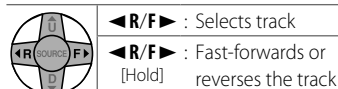

Notice:

When operating an iPod, some operations may not be performed correctly or as intended. In this case, visit the following JVC web site: <<http://www.jvc.co.jp/english/car/>> (English website only)

Listening to the other external components

You can connect an external component to:

- **EXT INPUT:** Expansion port on the rear of this unit using the following adapters (not supplied):

- **KS-U57**, Line Input Adapter

- **KS-U58**, AUX Input Adapter



Preparation: Make sure <EXT ON> is selected for the <SRC SELECT> → <EXT IN> setting.

(🔍 28)

- **AUX IN:** AUX (auxiliary) input jack on the control panel.

Preparation: Make sure <AUX ON> is selected for the <SRC SELECT> → <AUX IN> setting. (🔍 28)

- For details, refer also to the instructions supplied with the adapter or external components.

- 1  ⇒ "EXT INPUT" or "AUX IN"
- 2 **Turn on the connected component and start playing the source.**
- 3  ⇒ Adjust the volume.
- 4 **Adjust the sound as you want.** (🔍 23)

Connecting an external component to the AUX input jack

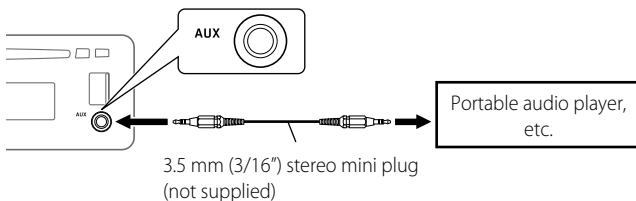

Selecting a preset sound mode

You can select a preset sound mode suitable for the music genre.



FLAT → NATURAL → DYNAMIC → VOCAL BOOST → BASS BOOST → USER → (back to the beginning)

While listening, you can adjust the tone level of the selected sound mode.

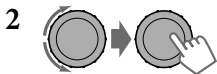

Adjust the level (-06 to +06) of the selected tone (BASS / MID / TRE).
The sound mode is automatically stored and changed to "USER."

Storing your own sound mode

You can store your own adjustments in memory.

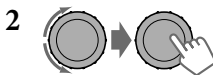

⇒ <PRO EQ> ⇒ <BASS> / <MIDDLE> / <TREBLE>

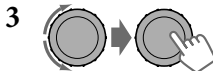

Adjust the sound elements of the selected tone. (🔍 table on the left)



4 Repeat steps 2 and 3 to adjust other tones.

The adjustments made will be stored automatically in "USER."

The current sound mode changes to "USER" automatically.

Tone	Sound element		
	Frequency	Level	Q
BASS	60 Hz	-06 to +06	Q1.0
	80 Hz		Q1.25
	100 Hz		Q1.5
	200 Hz		Q2.0
MIDDLE	0.5 kHz	-06 to +06	Q0.75
	1.0 kHz		Q1.0
	1.5 kHz		Q1.25
	2.5 kHz		
TREBLE	10.0 kHz	-06 to +06	Q FIX
	12.5 kHz		
	15.0 kHz		
	17.5 kHz		



Menu operations

1  [Hold]	2  → 	3 Repeat step 2 if necessary. <ul style="list-style-type: none"> • To return to the previous menu, press BACK. • To exit from the menu, press DISP or MENU.
---	--	---

Category	Menu item	Selectable setting, [Initial: <u>Underlined</u>]
DEMO	DEMO Display demonstration	<ul style="list-style-type: none"> • <u>DEMO ON</u> : Display demonstration will be activated automatically if no operation is done for about 20 seconds. • <u>DEMO OFF</u> : Cancels. (👁 4)
	CLOCK SET Clock setting	— : Adjust the hour, then the minute. (👁 4) [1:00]
CLOCK	CLOCK ADJ *1 Clock adjustment	<ul style="list-style-type: none"> • <u>AUTO</u> : The built-in clock is automatically adjusted using the clock data provided via the satellite radio channel. • <u>OFF</u> : Cancels.
	TIME ZONE *1,*2	<u>EASTERN,</u> <u>ATLANTIC,</u> <u>NEWFOUND,</u> <u>ALASKA,</u> <u>PACIFIC,</u> <u>MOUNTAIN,</u> <u>CENTRAL</u> : Select your residential area from one of the time zones for clock adjustment.
	DST *1,*2 Daylight savings time	<ul style="list-style-type: none"> • <u>DST ON</u> : Activates daylight savings time if your residential area is subject to DST. • <u>DST OFF</u> : Cancels.
	PRO EQ	— : For settings, (👁 23).
	BASS	
	MIDDLE	
	TREBLE	

*1 Displayed only when SIRIUS Satellite radio or XM Satellite radio is connected.

*2 Displayed only when <CLOCKADJ> is set to <AUTO>.

Category	Menu item	Selectable setting, [Initial: <u>Underlined</u>]
DISPLAY	DIMMER	<ul style="list-style-type: none"> • <u>DIMMER AUTO</u> : Dims the display when you turn on the headlights.*3 • DIMMER ON : Dims the display and button illumination. • DIMMER OFF : Cancels.
	SCROLL *4	<ul style="list-style-type: none"> • <u>SCROLL ONCE</u> : Scrolls the displayed information once. • SCROLL AUTO : Repeats scrolling (at 5-second intervals). • SCROLL OFF : Cancels. Pressing DISP for more than one second can scroll the display regardless of the setting.
	TAG DISPLAY	<ul style="list-style-type: none"> • <u>TAG ON</u> : Shows the Tag information while playing MP3/WMA tracks. • TAG OFF : Cancels.
TUNER	SSM *5 Strong-station Sequential Memory	<ul style="list-style-type: none"> • <u>SSM 01 – 06</u> *6 : For settings,  7. • SSM 07 – 12 • SSM 13 – 18
	AREA Tuner channel interval	<ul style="list-style-type: none"> • <u>AREA US</u> : When using in North/Central/South America. AM/FM intervals are set to 10 kHz/200 kHz. • AREA EU : When using in any other areas. AM/FM intervals are set to 9 kHz/50 kHz (100 kHz during auto search). • AREA SA : When using in South American countries where FM interval is 100 kHz. AM interval is set to 10 kHz.
	MONO *5 Monaural mode	<ul style="list-style-type: none"> • MONO ON : Activate monaural mode to improve FM reception, but stereo effect will be lost. ( 7) • <u>MONO OFF</u> : Restore the stereo effect.
	SID *7 SIRIUS ID	— : Your SIRIUS identification number scrolls on the display 5 seconds after "SID" is selected. ( 19) If no operation is done for about 60 seconds, the unit returns to playback mode.

*3 The illumination control lead connection is required. (See "Installation/Connection Manual.") This setting may not work correctly on some vehicles (particularly on those having a control dial for dimming). In this case, change the setting to any other than <DIMMER AUTO>.

*4 Some characters or symbols will not be shown correctly (or will be blanked) on the display.

*5 Displayed only when the source is "FM" or "HD Radio."

*6 If an HD Radio tuner box is connected, you can also search and store the AM stations to <SSM 01 – 06>.

*7 Displayed only when SIRIUS Satellite radio is connected.



Category	Menu item	Selectable setting, [Initial: <u>Underlined</u>]
TUNER	BLEND HOLD * ⁸ HD Radio reception mode	<ul style="list-style-type: none"> • <u>AUTO</u> : Switch between digital and analog audio automatically. (🔊 17) • <u>DIGITAL</u> : Tune in to digital audio only. • <u>ANALOG</u> : Tune in to analog audio only.
	IF BAND Intermediate frequency band	<ul style="list-style-type: none"> • <u>AUTO</u> : Increases the tuner selectivity to reduce interference noises between adjacent stations. (Stereo effect may be lost.) • <u>WIDE</u> : Subject to interference noises from adjacent stations, but sound quality will not be degraded and the stereo effect will remain.
COLOR	BUTTON ZONE	COLOR 01 — : For settings, 🗂️ 29. COLOR 29, USER : For settings, 🗂️ 29.
	DISP ZONE Display zone	
	ALL ZONE	: For settings, 🗂️ 29.
COLOR SETUP	DAY COLOR	<ul style="list-style-type: none"> • <u>BUTTON ZONE</u> : For settings, 🗂️ 30. • <u>DISP ZONE</u>
	NIGHT COLOR	<ul style="list-style-type: none"> • <u>BUTTON ZONE</u> : For settings, 🗂️ 30. • <u>DISP ZONE</u>
	MENU COLOR	<ul style="list-style-type: none"> • <u>ON</u> : Changes the display and buttons (except for EQ/BASS-TRE / DISP) illumination during menu, list search and playback mode operations. • <u>OFF</u> : Cancels.
	RING COLOR * ⁹	<ul style="list-style-type: none"> • <u>ON</u> : When a call comes in, the display will flash in blue. <ul style="list-style-type: none"> • The display will change to the original color when the call is answered or the incoming call stops. When the unit receives a text message, the display only illuminate in blue. • <u>OFF</u> : Cancels.

*⁸ Displayed only when HD Radio tuner box is connected.

*⁹ Displayed only when Bluetooth adapter, KS-BTA200 is connected.

Category	Menu item	Selectable setting, [Initial: <u>Underlined</u>]
AUDIO	FADER *10	R06 – F06 : Adjust the front and rear speaker output balance. [00]
	BALANCE *11	L06 – R06 : Adjust the left and right speaker output balance. [00]
	LOUD Loudness	• LOUD ON : Boost low and high frequencies to produce a well-balanced sound at a low volume level. • <u>LOUD OFF</u> : Cancels.
	VOL ADJUST Volume adjust	VOL ADJ -05 — : Preset the volume adjustment level of each source (except FM), compared to the FM volume level. The volume level will automatically increase or decrease when you change the source. VOL ADJ +05 <u>[VOL ADJ 00]</u> • Before making an adjustment, select the source you want to adjust. • "VOL ADJ FIX" appears on the display if "FM" is selected as the source.
	L/O MODE Line output mode	• SUB.W : Select if the REAR LINE OUT terminals are used for connecting a subwoofer (through an external amplifier). • <u>REAR</u> : Select if the REAR LINE OUT terminals are used for connecting the speakers (through an external amplifier).
	SUB.W FREQ *12 Subwoofer cutoff frequency	• LOW : Frequencies lower than 72 Hz are sent to the subwoofer. • <u>MID</u> : Frequencies lower than 111 Hz are sent to the subwoofer. • HIGH : Frequencies lower than 157 Hz are sent to the subwoofer.
	SUB.W LEVEL *12 Subwoofer level	SUB.W 00 — : Adjust the subwoofer output level. SUB.W 08 <u>[SUB.W 04]</u>

*10 If you are using a two-speaker system, set the fader level to "00."

*11 This adjustment will not affect the subwoofer output.

*12 Displayed only when <L/O MODE> is set to <SUB.W>.



Category	Menu item	Selectable setting, [Initial: <u>Underlined</u>]
AUDIO	BEEP Keytouch tone	<ul style="list-style-type: none"> • <u>BEEP ON</u> : Activates the keypress tone. • <u>BEEP OFF</u> : Deactivates the keypress tone.
	AMP GAIN *13 Amplifier gain control	<ul style="list-style-type: none"> • <u>LOW POWER</u> : VOLUME 00 – VOLUME 30 (Select if the maximum power of each speaker is less than 50 W to prevent damaging the speakers.) • <u>HIGH POWER</u> : VOLUME 00 – VOLUME 50
SRC SELECT	AM *14 AM station	<ul style="list-style-type: none"> • <u>AM ON</u> : Enable “AM” in source selection. • <u>AM OFF</u> : Disable “AM” in source selection.
	EXT IN *15 External input	<ul style="list-style-type: none"> • <u>EXT ON</u> : Enable “EXT IN” in source selection. • <u>EXT OFF</u> : Disable “EXT IN” in source selection.
	AUX IN *16 Auxiliary input	<ul style="list-style-type: none"> • <u>AUX ON</u> : Enable “AUX IN” in source selection. • <u>AUX OFF</u> : Disable “AUX IN” in source selection.
AUDIOBOOKS	AUDIOBOOKS *17 Speed control of “Audiobooks”	<ul style="list-style-type: none"> • <u>NORMAL</u> : You can select the playback speed of the “Audiobook” sound file in your iPod. • <u>FASTER</u> • <u>SLOWER</u> : Initial selected item depends on your iPod setting.
IPOD SWITCH	IPOD SWITCH *18 iPod/iPhone control	<ul style="list-style-type: none"> • <u>HEAD MODE</u> : Controls iPod playback through the unit. • <u>IPOD MODE</u> : Controls iPod playback through the iPod/iPhone.

*13 The volume level automatically changes to “VOLUME 30” if you change to <LOW POWER> with the volume level set higher than “VOLUME 30.”

*14 Displayed only when any source other than “AM” is selected.

*15 Displayed only when any source other than “EXT IN” is selected.

*16 Displayed only when any source other than “AUX IN” is selected.

*17 Displayed only when an iPod is connected and playback is controlled from the unit.

*18 Displayed only when “USB-IPOD” is selected as the source and “IPOD MODE” is available for the connected iPod/iPhone (🔍 34).

Selecting the variable buttons and display color illumination

You can select your preferred color for buttons illumination (except for **EQ/BASS-TRE / DISP**) and display color separately.

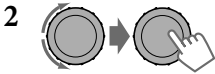
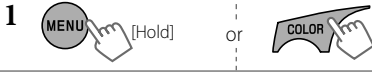
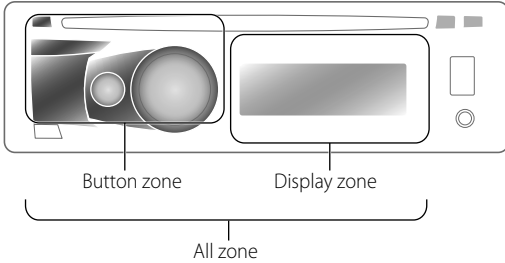

⇒ <COLOR> ⇒ <BUTTON ZONE> / <DISP ZONE> / <ALL ZONE>

• Pressing **COLOR** in step **1** will enter zone selection menu (BUTTON ZONE / DISP ZONE / ALL ZONE) directly.

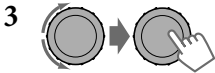

⇒ Select your preferred color from one of the 29 preset colors or <USER> color.

4 Repeat steps **2** and **3** to select a different zone and your preferred color.

- If <ALL ZONE> is selected in step **2**, the buttons and display illumination changed to the current/selected <BUTTON ZONE> color.

You can also change the <ALL ZONE> color to one of your preferred color by performing step **3**.



⇒ Exit from the setting.



Creating your own day and night colors—USER

You can create your own colors for <DAY COLOR> and <NIGHT COLOR> to apply to button zone and display zone.

- <DAY COLOR> Displayed when <DIMMER> is set to <DIMMER OFF>.
- <NIGHT COLOR> Displayed when <DIMMER> is set to <DIMMER ON>.

Menu hierarchy		Operation	
COLOR SETUP	DAY COLOR	• BUTTON ZONE	Follow example below.
		• DISP ZONE	Press BACK after step 5, then select DISP ZONE in step 2.
	NIGHT COLOR	• BUTTON ZONE	Press BACK after step 5, then select NIGHT COLOR in step 2.
		• DISP ZONE	

Ex.: Creating <USER> color for <BUTTON ZONE> in <DAY COLOR>.

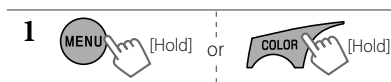

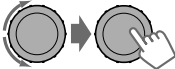
- 2** 
- ⇒ <COLOR SETUP> ⇒ <DAY COLOR>
⇒ <BUTTON ZONE>
- Pressing **COLOR** in step 1 will enter zone selection menu (BUTTON ZONE / DISP ZONE) directly.

- 3** 
- ⇒ Select a primary color.
RED ↔ GREEN ↔ BLUE ↔ (back to the beginning)

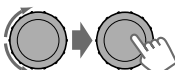
- 4** 
- ⇒ Adjust the level of the selected primary color.
00 to 31

- 5** Repeat steps 3 and 4 to adjust other primary colors.

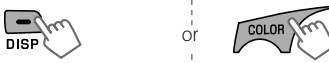
- 6**  [Hold] or [Hold]
- ⇒ Exit from the setting.

If "00" is selected for all the primary colors (as in step 4) for <DISP ZONE>, nothing appear on the display.

More about this unit

Basic operations

General

- If you turn off the power while listening to a track, playback will start from where it had been stopped previously next time you turn on the power.
- If no operation is done for about 60 seconds after pressing **MENU** button, the operation will be canceled.

Tuner operations

Storing stations in memory

- During SSM search...
 - All previously stored stations are erased and the stations are stored anew.
 - When SSM is over, the station stored in the lowest preset number will be automatically tuned in.
- When storing a station manually, the previously preset station is erased when a new station is stored in the same preset number.

Disc/USB operations

Caution for DualDisc playback

- The Non-DVD side of a "DualDisc" does not comply with the "Compact Disc Digital Audio" standard. Therefore, the use of Non-DVD side of a DualDisc on this product may not be recommended.

General

- This unit has been designed to reproduce CDs/CD Texts, and CD-Rs (Recordable)/CD-RWs (Rewritable) in audio CD (CD-DA), MP3 and WMA formats.
- If you change the source while listening to a disc, playback stops. Next time you select "CD" as the playback source, playback will start from where it had been stopped previously.

- When a disc is inserted upside down, "PLEASE" and "EJECT" appear alternately on the display. Press ▲ to eject the disc.
- If the ejected disc is not removed within 15 seconds, it is automatically inserted into the loading slot again to protect it from dust. Playback starts automatically.
- MP3 and WMA "tracks" (words "file" and "track" are used interchangeably) are recorded in "folders."
- While fast-forwarding or reversing on an MP3 or WMA disc, you can only hear intermittent sounds.

Playing a CD-R or CD-RW

- Use only "finalized" CD-Rs or CD-RWs.
- This unit can only play back files of the same type as those detected first if a disc includes both audio CD (CD-DA) files and MP3/WMA files.
- This unit can play back multi-session discs; however, unclosed sessions will be skipped while playing.
- Some CD-Rs or CD-RWs may not play back on this unit because of their disc characteristics, or for the following reasons:
 - Discs are dirty or scratched.
 - Moisture condensation has occurred on the lens inside the unit.
 - The pickup lens inside the unit is dirty.
 - The files on the CD-R/CD-RW are written using the "Packet Write" method.
 - There are improper recording conditions (missing data, etc.) or media conditions (stained, scratched, warped, etc.).
- CD-RWs may require a longer readout time since the reflectance of CD-RWs is lower than that of regular CDs.



- Do not use the following CD-Rs or CD-RWs:
 - Discs with stickers, labels, or a protective seal stuck to the surface.
 - Discs on which labels can be directly printed by an ink jet printer.
- Using these discs under high temperature or high humidity may cause malfunctions or damage to the unit.

Playing an MP3/WMA disc

- This unit can play back MP3/WMA files with the extension code <.mp3> or <.wma> (regardless of the letter case—upper/lower).
- This unit can show the names of albums, artists (performer), and Tag (Version 1.0, 1.1, 2.2, 2.3, or 2.4) for MP3 files and for WMA files.
- This unit can display only one-byte characters. No other characters can be correctly displayed.
- This unit can play back MP3/WMA files meeting the conditions below:
 - Bit rate of MP3/WMA: 32 kbps — 320 kbps
 - Sampling frequency of MP3:
 - 32 kHz, 44.1 kHz, 48 kHz (for MPEG-1)
 - 16 kHz, 22.05 kHz, 24 kHz (for MPEG-2)
 - Sampling frequency of WMA:
 - 22.05 kHz, 32 kHz, 44.1 kHz, 48 kHz
 - Disc format: ISO 9660 Level 1/Level 2, Romeo, Joliet, Windows extension
- The maximum number of characters for file/folder names vary depending on the disc format used (includes 4 extension characters—<.mp3> or <.wma>).
 - ISO 9660 Level 1: up to 12 characters
 - ISO 9660 Level 2: up to 31 characters
 - Romeo: up to 64 characters
 - Joliet: up to 32 characters
 - Windows extension: up to 64 characters
- This unit can recognize a total of 512 files, 255 folders, and 8 hierarchical levels.
- This unit can play back files recorded in VBR (variable bit rate).

Files recorded in VBR have a discrepancy in the elapsed time display, and do not show the actual elapsed time. In particular, this difference becomes noticeable after performing the search function.
- This unit cannot play back the following files:
 - MP3 files encoded in MP3i and MP3 PRO format.
 - MP3 files encoded in an inappropriate format.
 - MP3 files encoded with Layer 1/2.
 - WMA files encoded in lossless, professional, and voice format.
 - WMA files which are not based upon Windows Media® Audio.
 - WMA files copy-protected with DRM.
 - Files which have data such as AIFF, ATRAC3, etc.
- The search function works but search speed is not constant.

Playing MP3/WMA tracks from a USB device

- While playing from a USB device, the playback order may differ from other players.
- This unit may be unable to play back some USB devices or some files due to their characteristics or recording conditions.
- Depending on the shape of the USB devices and connection ports, some USB devices may not be attached properly or the connection might be loose.
- Connect one USB mass storage class device to the unit at a time. Do not use a USB hub.
- If the connected USB device does not have the correct files, "CANNOT PLAY" appears.
- This unit can show Tag (Version 1.0, 1.1, 2.2, 2.3, or 2.4) for MP3 files and for WMA files.
- This unit can play back MP3/WMA files meeting the conditions below:
 - Bit rate of MP3/WMA: 32 kbps — 320 kbps
 - Sampling frequency of MP3:
 - 32 kHz, 44.1 kHz, 48 kHz (for MPEG-1)
 - 16 kHz, 22.05 kHz, 24 kHz (for MPEG-2)
 - Sampling frequency of WMA:
 - 22.05 kHz, 32 kHz, 44.1 kHz, 48 kHz

- This unit can play back MP3 files recorded in VBR (variable bit rate).
- The maximum number of characters for:
 - Folder names : 32 characters
 - File names : 32 characters
 - MP3 Tag : 64 characters
 - WMA Tag : 32 characters
- This unit can recognize a total of 5 000 files, 255 folders (255 files per folder including folder without unsupported files), and of 8 hierarchies.
- This unit does not support SD card reader.
- This unit cannot recognize a USB device whose rating is other than 5 V and exceeds 500 mA.
- USB devices equipped with special functions such as data security functions cannot be used with the unit.
- Do not use a USB device with 2 or more partitions.
- This unit may not recognize a USB device connected through a USB card reader.
- This unit may not play back files in a USB device properly when using a USB extension cord.
- This unit cannot play back the following files:
 - MP3 files encoded in MP3i and MP3 PRO format.
 - MP3 files encoded in an inappropriate format.
 - MP3 files encoded with Layer 1/2.
 - WMA files encoded in lossless, professional, and voice format.
 - WMA files which are not based upon Windows Media® Audio.

Bluetooth operations

- While driving, do not perform complicated operation such as dialing the numbers, using phone book, etc. When you perform these operations, stop your car in a safe place.
- Some Bluetooth devices may not be connected to this unit depending on the Bluetooth version of the device.
- This unit may not work for some Bluetooth devices.
- Connecting condition may vary depending on the circumstances around you.
- When the unit is turned off, the device is disconnected.

HD Radio reception

- HD Radio broadcasting can normally be received in the USA, and it may also be received in countries where limited broadcasting has already begun.
- During SSM search...
 - All stations including conventional FM/AM stations are searched and stored for the selected band.

Satellite radio

- To know more about SIRIUS Satellite radio or to sign up, visit <<http://www.sirius.com>>.
- For the latest channel listings and programming information, or to sign up for XM Satellite radio, visit <<http://www.xmradio.com>>.



iPod/iPhone operations

- You can control the following types of iPods/iPhone:

- iPod with video (5th Generation) *1
- iPod classic *1, *2
- iPod nano
- iPod nano (2nd Generation)
- iPod nano (3rd Generation) *1, *2
- iPod nano (4th Generation) *1, *2
- iPod nano (5th Generation) *1, *2
- iPod touch *1, *2
- iPod touch (2nd Generation) *1, *2
- iPhone/iPhone 3G/iPhone 3GS *1, *2

*1 *It is not possible to browse video files on the "Videos" menu.*

*2 <IPOD MODE> is available (📶 20).

- If the iPod does not play correctly, please update your iPod software to the latest version. For details about updating your iPod, visit <<http://www.apple.com>>.
- When you turn on this unit, the iPod is charged through this unit.
- iPod shuffle cannot be used with this unit.
- The song order displayed on the selection menu of this unit may differ from that of the iPod.
- The text information may not be displayed correctly:
 - Some characters such as accented letters cannot be shown correctly on the display.
 - Communication between the iPod and the unit is not stable.
- If the text information includes more than 11 characters, it scrolls on the display. This unit can display up to 64 characters.

- Microsoft and Windows Media are either registered trademarks or trademarks of Microsoft Corporation in the United States and/or other countries.
- The Bluetooth word mark and logos are owned by the Bluetooth SIG, Inc. and any use of such marks by Victor Company of Japan, Limited (JVC) is under license. Other trademarks and trade names are those of their respective owners.
- HD Radio™ and the HD Radio Ready logo are proprietary trademarks of iBiquity Digital Corp.
- "SIRIUS" and the SIRIUS dog logo are registered trademarks of SIRIUS Satellite Radio Inc.
- XM and its corresponding logos are registered trademarks of XM Satellite Radio Inc.
- "SAT Radio," the SAT Radio logo and all related marks are trademarks of SIRIUS Satellite Radio Inc., and XM Satellite Radio, Inc.
- "Made for iPod" means that an electronic accessory has been designed to connect specifically to iPod and has been certified by the developer to meet Apple performance standards.
- "Works with iPhone" means that an electronic accessory has been designed to connect specifically to iPhone and has been certified by the developer to meet Apple performance standards.
- Apple is not responsible for the operation of this device or its compliance with safety and regulatory standards.
- iPod is a trademark of Apple Inc., registered in the U.S. and other countries.
- iPhone is a trademark of Apple Inc.

Maintenance

How to clean the connectors

Frequent detachment will deteriorate the connectors.

To minimize this possibility, periodically wipe the connectors with a cotton swab or cloth moistened with alcohol, being careful not to damage the connectors.

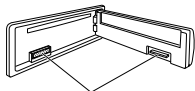

Connectors

Moisture condensation

Moisture may condense on the lens inside the unit in the following cases:

- After starting the heater in the car.
 - If it becomes very humid inside the car.
- Should this occur, the unit may malfunction. In this case, eject the disc and leave the unit turned on for a few hours until the moisture has evaporated.

How to handle discs

When removing a disc from its case, press down the center holder of the case and lift the disc out, holding it by the edges.

Center holder

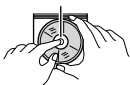

- Always hold the disc by the edges. Do not touch its recording surface.

When storing a disc in its case, gently insert the disc around the center holder (with the printed surface facing up).

- Make sure to store discs in cases after use.

To keep discs clean

A dirty disc may not play correctly. If a disc does become dirty, wipe it with a soft cloth in a straight line from center to edge.



- Do not use any solvents (for example, conventional record cleaner, spray, thinner, benzene, etc.) to clean discs.







To play new discs

New discs may have some rough spots around the inner and outer edges. If such a disc is used, this unit may reject the disc.



To remove these rough spots, rub the edges with a pencil or ball-point pen, etc.

Do not use the following discs:

Single CD—8 cm (3-3/16") disc 	Warped disc 
Sticker and sticker residue 	Stick-on label 
Unusual shape 	C-thru Disc (semitransparent disc) 
Transparent or semitransparent parts on its recording area 	

Troubleshooting

	Symptom	Remedy/Cause
General	Sound cannot be heard from the speakers.	<ul style="list-style-type: none"> • Adjust the volume to the optimum level. • Make sure the unit is not muted/paused (🔊 6). • Check the cords and connections.
	“PROTECT” appears on the display and no operations can be done.	<p>Check to be sure the terminals of the speaker leads are covered with insulating tape properly, then reset the unit (🔊 3).</p> <p>If “PROTECT” does not disappear, consult your JVC car audio dealer or a company supplying kits.</p>
	The unit does not work at all.	Reset the unit. (🔊 3)
	“AUX IN” cannot be selected.	Check the <SRC SELECT> → <AUX IN> setting. (🔊 28)
	Nothing appear on the display.	Check the <USER> color settings. (🔊 30)
FM/AM	SSM automatic presetting does not work.	Store stations manually.
	Static noise while listening to the radio.	Connect the antenna firmly.
	“AM” cannot be selected.	Check the <SRC SELECT> → <AM> setting. (🔊 28)
Disc playback	Disc cannot be played back.	Insert the disc correctly.
	<ul style="list-style-type: none"> • CD-R/CD-RW cannot be played back. • Tracks on the CD-R/CD-RW cannot be skipped. 	<ul style="list-style-type: none"> • Insert a finalized CD-R/CD-RW. • Finalize the CD-R/CD-RW with the component which you used for recording.
	Disc can neither be played back nor ejected.	<ul style="list-style-type: none"> • Unlock the disc. (🔊 9) • Eject the disc forcibly. (🔊 3)
	Disc sound is sometimes interrupted.	<ul style="list-style-type: none"> • Stop playback while driving on rough roads. • Change the disc. • Check the cords and connections.
	“NO DISC” appears on the display.	Insert a playable disc into the loading slot.
	“PLEASE” and “EJECT” appear alternately on the display.	Press ▲, then insert a disc correctly.

	Symptom	Remedy/Cause
MP3/WMA playback	Disc cannot be played back.	<ul style="list-style-type: none"> • Use a disc with MP3/WMA tracks recorded in a format compliant with ISO 9660 Level 1, Level 2, Romeo, or Joliet. • Add the extension code <.mp3> or <.wma> to the file names.
	Noise is generated.	Skip to another track or change the disc. (Do not add the extension code <.mp3> or <.wma> to non-MP3 or WMA tracks.)
	A longer readout time is required ("READING" keeps flashing on the display).	Do not use too many hierarchical levels and folders.
	Tracks do not play back in the order you have intended them to play.	The playback order is determined when the files are recorded.
	The elapsed playing time is not correct.	This sometimes occurs during playback. This is caused by how the tracks are recorded on the disc.
	"NO FILE" appears on the display.	Selected folder is an empty folder*1. Select another folder that contains MP3/WMA tracks.
	"NOT SUPPORT" appears on the display and track skips.	Skip to the next track encoded in an appropriate format or to the next non-copy-protected WMA track.
The correct characters are not displayed (e.g. album name).	This unit can only display letters (upper case), numbers, and a limited number of symbols. (🔍 8)	

*1 Folder that is physically empty or folder that contains data but does not contain valid MP3/WMA track.



	Symptom	Remedy/Cause
USB device playback	Noise is generated.	The track played back is not an MP3/WMA track. Skip to another file. (Do not add the extension code <.mp3> or <.wma> to non-MP3 or WMA tracks.)
	"READING" keeps flashing on the display.	<ul style="list-style-type: none"> • Readout time varies depending on the USB device. • Do not use too many hierarchy or folders. • Turn off the power then on again. • Reattach the USB device again.
	"NO FILE" appears on the display.	Check whether the selected folder, the connected USB device, or the iPod/iPhone contains a playable file.
	"NOT SUPPORT" appears on the display and track skips.	Skip to the next track encoded in an appropriate format or to the next non-copy-protected WMA track.
	Tracks/folders are not played back in the order you have intended.	The playback order is determined by the write-in time stamp. The first track/folder written into the USB device will be the first track/folder for playback.
	<ul style="list-style-type: none"> • "CANNOT PLAY" flashes on the display. • "NO USB" appears on the display. • The unit cannot detect the USB device. 	<ul style="list-style-type: none"> • Attach a USB device that contains tracks encoded in an appropriate format. • Reattach the USB device again.
	While playing a track, sound is sometimes interrupted.	The MP3/WMA tracks have not been properly copied into the USB device. Copy MP3/WMA tracks again into the USB device, and try again.
	Correct characters are not displayed (e.g. album name).	This unit can only display letters (upper case), numbers, and a limited number of symbols. (📎 8)
Bluetooth *2	Bluetooth device does not detect the unit.	The unit can be connected with one Bluetooth mobile phone and one Bluetooth audio device at a time. While connecting a device, this unit cannot be detected from another device. Disconnect currently connected device and search again.
	The unit does not detect the Bluetooth device.	<ul style="list-style-type: none"> • Check the Bluetooth setting of the device. • Search from the Bluetooth device. After the device detects the unit, select "OPEN" on the unit to connect the device. (📎 11)

*2 For Bluetooth operations, refer also to the instructions supplied with the Bluetooth Adapter.

	Symptom	Remedy/Cause
Bluetooth *2	The unit does not make pairing with the Bluetooth device.	<ul style="list-style-type: none"> • Enter the same PIN code for both the unit and target device. • Select the device name from "SPECIAL," then try to connect again. (🔍 12) • Try to pair/connect from the Bluetooth device.
	Echo or noise occurs.	Adjust the microphone unit position.
	Phone sound quality is poor.	<ul style="list-style-type: none"> • Reduce the distance between the unit and the Bluetooth mobile phone. • Move the car to a place where you can get a better signal reception.
	The sound is interrupted or skipped during playback of a Bluetooth audio device.	<ul style="list-style-type: none"> • Reduce the distance between the unit and the Bluetooth audio device. • Disconnect the device connected for "BT-PHONE." • Turn off, then turn on the unit. • (When the sound is not yet restored,) connect the device again.
	The connected audio device cannot be controlled.	Check whether the connected audio device supports AVRCP (Audio/Video Remote Control Profile).
HD Radio reception	Sound quality changes when receiving HD Radio stations.	Fix the reception mode either to <DIGITAL> or <ANALOG>. (🔍 17, 26)
	No sound can be heard.	<ul style="list-style-type: none"> • <ANALOG> is selected when receiving all digital broadcast of HD Radio station. Select <DIGITAL> or <AUTO>. (🔍 17, 26) • <DIGITAL> is selected when receiving weak digital signals or receiving conventional radio broadcast. Select <ANALOG> or <AUTO>. (🔍 17, 26)
	"RESET 8" appears on the display.	Reconnect this unit and the HD Radio tuner box correctly, then reset the unit.



	Symptom	Remedy/Cause
Satellite Radio	"CALL 1-888-539-SIRIUS TO SUBSCRIBE" scrolls on the display while listening to the SIRIUS Satellite radio.	Starts subscribing to SIRIUS Satellite radio. (📶 18)
	No sound can be heard. "UPDATING" appears on the display.	The unit is updating the channel information and it takes a few minutes to complete.
	"ACQUIRING" or "NO SIGNAL" appears on the display.	Move to an area where signals are stronger.
	"NO ANTENNA" or "ANTENNA" appears on the display.	Connect the antenna firmly.
	"NO CHANNEL" appears on the display for about 5 seconds, then returns to the previous channel or default channel while listening to the SIRIUS Satellite radio.	No broadcast on the selected channel. Select another channel or continue listening to the previous channel or default channel.
	Blank display appears.	No text information for the selected channel.
	"CH---" or "CH UNAVAIL" appears on the display for about 2 seconds, then returns to the previous channel while listening to the XM Satellite radio.	Selected channel is no longer available or is unauthorized. Select another channel or continue listening to the previous channel.
	"OFF AIR" appears on the display while listening to the XM Satellite radio.	Selected channel is not broadcasting at this time. Select another channel or continue listening to the previous channel.
	"LOADING" appears on the display while listening to the XM Satellite radio.	The unit is loading the channel information and audio. Text information are temporarily unavailable.
	<ul style="list-style-type: none"> • "RESET 8" appears on the display. • Satellite radio does not work at all. 	Reconnect this unit and the satellite radio correctly and reset this unit.

	Symptom	Remedy/Cause
iPod/iPhone	The iPod does not turn on or does not work.	<ul style="list-style-type: none"> • Check the connecting cable and its connection. • Update the firmware version of the iPod/iPhone. • Charge the battery of the iPod/iPhone. • Reset the iPod/iPhone. • Check whether <IPOD SWITCH> setting is appropriate (🔍 28).
	The sound is distorted.	Deactivate the equalizer either on this unit or the iPod/iPhone.
	A lot of noise is generated.	Turn off (uncheck) the "VoiceOver" feature of the iPod. For details, visit < http://www.apple.com >.
	Playback stops.	The headphones are disconnected during playback. Restart the playback operation (🔍 20).
	"CANNOT PLAY" appears on the display.	No tracks are stored. Import tracks to the iPod/iPhone.
	"RESTRICTED" appears on the display.	Check whether the connected iPod/iPhone is compatible with this unit (🔍 34).

JVC bears no responsibility for any loss of data in an iPod/iPhone and/or USB mass storage class device while using this System.

Specifications

AUDIO AMPLIFIER SECTION	Power Output:	20 W RMS × 4 Channels at 4 Ω and ≤ 1% THD+N		
	Signal-to-Noise Ratio:	80 dBA (reference: 1 W into 4 Ω)		
	Load Impedance:	4 Ω (4 Ω to 8 Ω allowance)		
	Tone Control Range:	Bass:	±12 dB (60 Hz, 80 Hz, 100 Hz, 200 Hz) Q1.0, Q1.25, Q1.5, Q2.0	
		Middle:	±12 dB (0.5 kHz, 1.0 kHz, 1.5 kHz, 2.5 kHz) Q0.75, Q1.0, Q1.25	
		Treble:	±12 dB (10.0 kHz, 12.5 kHz, 15.0 kHz, 17.5 kHz) Q (Fixed)	
	Frequency Response:	40 Hz to 20 000 Hz		
	Line-Out/subwoofer-Out Level/Impedance:	KD-R618/ KD-A615:	5.0 V/20 kΩ load (full scale)	
		KD-R610:	2.5 V/20 kΩ load (full scale)	
		Output Impedance:	1 kΩ	
Other Terminal:	AUX (auxiliary) input jack, USB input jack, Antenna input, Expansion port, Steering wheel remote input (for KD-R618/KD-A615)			
TUNER SECTION	Frequency Range:	FM:	with channel interval set to 100 kHz or 200 kHz	87.5 MHz to 107.9 MHz
			with channel interval set to 50 kHz	87.5 MHz to 108.0 MHz
		AM:	with channel interval set to 10 kHz	530 kHz to 1 710 kHz
			with channel interval set to 9 kHz	531 kHz to 1 602 kHz
	FM Tuner:	Usable Sensitivity:	9.3 dBf (0.8 μV/75 Ω)	
		50 dB Quieting Sensitivity:	16.3 dBf (1.8 μV/75 Ω)	
		Alternate Channel Selectivity (400 kHz):	65 dB	
		Frequency Response:	40 Hz to 15 000 Hz	
		Stereo Separation:	40 dB	
	AM Tuner:	Sensitivity:	20 μV	
Selectivity:		40 dB		

CD PLAYER SECTION	Type:		Compact disc player	
	Signal Detection System:		Non-contact optical pickup (semiconductor laser)	
	Number of Channels:		2 channels (stereo)	
	Frequency Response:		5 Hz to 20 000 Hz	
	Dynamic Range:		96 dB	
	Signal-to-Noise Ratio:		98 dB	
	Wow and Flutter:		Less than measurable limit	
	MP3 Decoding Format: (MPEG1/2 Audio Layer 3)		Max. Bit Rate: 320 kbps	
	WMA (Windows Media® Audio) Decoding Format:		Max. Bit Rate: 320 kbps	
USB SECTION	USB Standard:		USB 1.1, USB 2.0	
	Data Transfer Rate (Full Speed):		Max. 12 Mbps	
	Compatible Device:		Mass storage class	
	Compatible File System:		FAT 32/16/12	
	Playable Audio Format:		MP3/WMA	
	Max. Current:		DC 5 V $\overline{\text{---}}$ 500 mA	
GENERAL	Power Requirement:	Operating Voltage:	DC 14.4 V (11 V to 16 V allowance)	
	Grounding System:		Negative ground	
	Allowable Operating Temperature:		0°C to +40°C (32°F to 104°F)	
	Dimensions (W x H x D): (approx.)	Installation Size:	182 mm x 52 mm x 160 mm (7-3/16" x 2-1/16" x 6-5/16")	
		Panel Size:	188 mm x 58 mm x 6 mm (7-7/16" x 2-5/16" x 1/4")	
	Mass:		1.3 kg (2.9 lbs) (excluding accessories)	

Design and specifications are subject to change without notice.

If a kit is necessary for your car, consult your telephone directory for the nearest car audio speciality shop.



■ The countries where you may use the Bluetooth® function

- Die Länder, in denen Sie die Bluetooth® Funktion verwenden können
 - Pays où vous pouvez utiliser la fonction Bluetooth®
 - De landen waar u de Bluetooth®-functie mag gebruiken
 - Países en los que se puede utilizar la función Bluetooth®
 - Paesi nei quali è possibile utilizzare la funzione Bluetooth®
 - Länder där du kan använda Bluetooth®-funktionen
 - Lande, hvor du kan bruge Bluetooth®-funktionerne
 - Land hvor du kan bruke Bluetooth®-funksjonen
 - Maat, joissa voi käyttää Bluetooth®-toimintoa
 - Países onde pode usar a função Bluetooth®
 - Οι χώρες όπου μπορείτε να χρησιμοποιήσετε τη λειτουργία Bluetooth®
 - Страны, где можно воспользоваться функцией Bluetooth®
 - Země, ve kterých můžete využívat funkci Bluetooth®
 - Azok az országok, amelyekben használhatjuk a Bluetooth®-funkciót
 - Kraje, w których można używać funkcji Bluetooth®
 - Države, kjer lahko uporabljate funkcijo Bluetooth®
 - Krajiny, v ktorých môžete využívať funkciu Bluetooth®
 - Valstis, kur jūs varat izmantot Bluetooth® funkciju
 - Šalys, kuriose galite naudotis „Bluetooth®“ funkcija
 - Il-pajjiżi fejn tista' tuża l-funzjoni Bluetooth®
 - Lönd þar sem hægt er að nota Bluetooth®
 - Riigid, kus on võimalik kasutada Bluetooth® funktsiooni
 - Bluetooth® fonksiyonunu kullanabileceğiniz ülkeler
 - Na tíortha inar féidir leat feidhmiú Bluetooth® a úsáid
 - Länner an denen der d'Bluetooth® Funktioun benotze könnt.
 - Ở những quốc gia mà bạn có thể sử dụng chức năng Bluetooth®
 - Els països on podrà fer servir la funció Bluetooth®
 - Zemlje u kojima je dozvoljena upotreba Bluetooth® funkcije.
 - Zemlje u kojima možete koristiti Bluetooth® funkciju
 - Zemlje u kojima je dopušteno koristiti Bluetooth®.
 - Земљи каде можете да ја користите функцијата Bluetooth®
 - Страните, в които можете да ползвате функцията Bluetooth®
 - Tärile in care puteți utiliza funcția Bluetooth®
 - Die lande waar u die Bluetooth®-funksie kan gebruik
 - Amazwe lapho ungasebenzisa khona uhlelo lwe-Bluetooth®
 - Negara-negara yang membolehkan penggunaan fungsi Bluetooth®
 - Negara-negara yang anda boleh menggunakan fungsi Bluetooth®
 - 您能够使用 Bluetooth® 功能的国家
 - 您能夠使用 Bluetooth® 功能的國家
- המדינות שבהן באפשרותך להשתמש ב־Bluetooth®
- الدول التي يمكنك استخدامها وظيفة Bluetooth® فيها

Country
Andorra
الإمارات العربية المتحدة
Australia
Österreich
Bosna i Hercegovina
Belgien Belgique
България
Canada
Schweiz Suisse
Κύπρος Kıbrıs
Česká republika
Deutschland
Danmark
Eesti
España
Suomi Finland
France
United Kingdom
Ελλάδα
Hong Kong 香港 香港
Hrvatska
Magyarország
Indonesia
Ireland Éire
ישראל إسرائيل
Ísland
Italia
Lichtenstein
Lietuva

Country
Luxemburg Luxembourg Lëtzebuerg
Latvija
Monaco
Crna Gora
Македонија
Malta
Nederland
Norge
New Zealand
Polska
Portugal
România
Srbija
Россия
Sverige
Singapore 新加坡 Singapura
Slovenija
Slovensko
Türkiye
台灣
United States of America
Vietnam Việt Nam
South Africa ENingizimu Afrika Suid-Afrika

Having TROUBLE with operation?
Please reset your unit
Refer to page of How to reset your unit
Still having trouble??

USA ONLY

Call 1-800-252-5722

<http://www.jvc.com>

We can help you!

JVC



EN, SP, FR

© 2009 Victor Company of Japan, Limited

1209DTSMDTJEIN

JVC KD-R618/KD-A615/KD-R610

Installation/Connection Manual

Manual de instalación/conexión

Manuel d'installation/raccordement

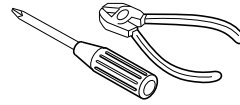

GET0638-002A
[J]

1209DTSMDTJEIN
EN, SP, FR

© 2009 Victor Company of Japan, Limited

ENGLISH / ESPAÑOL / FRANÇAIS

You need the installation kits which corresponds to your car. / Necesitará los kits de instalación que corresponden con su vehículo. / Vous avez besoin des kits d'installation correspondants à votre voiture.

Check the battery system in your car / Verifique el sistema de batería de su vehículo / Vérifiez le système de batterie de votre voiture

12 V DC, NEGATIVE ground / 12 V CC, NEGATIVO a masa / 12 VCC, masse NÉGATIVE

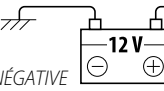

To the car system / Al sistema de automóvil / Au système autoradio

WARNINGS / ADVERTENCIAS / AVERTISSEMENTS

- To prevent short circuits:
 - Disconnect the battery's negative terminal and make all electrical connections before installing the unit.
 - Cover the terminals of the UNUSED leads with insulating tape.
- Be sure to ground this unit to the car's chassis again after installation.
- Replace the fuse with one of the specified rating.
- Connect speakers with a maximum power of more than 50 W (impedance of 4 Ω to 8 Ω). Otherwise, change the <AMP GAIN> setting. (See page 28 of the INSTRUCTIONS.)
- The heat sink becomes very hot after use. Be careful not to touch it when removing this unit.

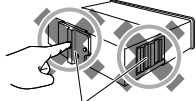

Heat sink / Sumidero térmico / Dissipateur de chaleur

- Para evitar cortocircuitos:
 - Desconecte el terminal negativo de la batería y realice todas las conexiones eléctricas antes de instalar la unidad.
 - Cubra los terminales de los conductores NO UTILIZADOS con cinta aislante.
- Asegúrese de volver a conectar a masa esta unidad al chasis del automóvil después de la instalación.
- Reemplace el fusible por uno con la corriente especificada.
- Conecte los altavoces con una potencia máxima de más de 50 W (impedancia de 4 Ω a 8 Ω). De lo contrario, cambie el ajuste <AMP GAIN>. (Véase la página 28 del MANUAL DE INSTRUCCIONES).
- El sumidero térmico estará muy caliente después del uso. Asegúrese de no tocarlo al desmontar esta unidad.

- Pour éviter les courts-circuits:
 - Déconnectez la borne négative de la batterie et réalisez toutes les connexions avant d'installer l'appareil.
 - Recouvrez les prises des fils NON UTILISÉS avec du ruban isolant.
- Assurez-vous de raccorder de nouveau la mise à la masse de cet appareil au châssis de la voiture après l'installation.
- Remplacer le fusible par un de la valeur précisée.
- Connectez des enceintes avec une puissance maximum de 50 W (impédance de 4 Ω à 8 Ω). Sinon, changez le réglage <AMP GAIN>. (Voir la page 28 du MANUEL D'INSTRUCTIONS.)
- Le dissipateur de chaleur devient très chaud après usage. Faire attention de ne pas le toucher en retirant cet appareil.

PRECAUTIONS on power supply and speaker connections

- DO NOT connect the speaker leads of the power cord to the car battery; otherwise, the unit will be seriously damaged.
- BEFORE connecting the speaker leads of the power cord to the speakers, check the speaker wiring in your car.

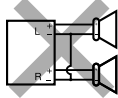

PRECAUCIONES sobre las conexiones de la fuente de alimentación y de los altavoces

- NO conecte los conductores de altavoz del cable de alimentación a la batería de automóvil, pues podrían producirse graves daños en la unidad.
- ANTES de conectar a los altavoces los conductores de altavoz del cable de alimentación, verifique el conexionado de altavoz de su automóvil.

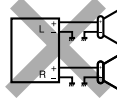

PRECAUTIONS sur l'alimentation et la connexion des enceintes

- NE CONNECTEZ PAS les fils d'enceintes du cordon d'alimentation à la batterie; sinon, l'appareil serait sérieusement endommagé.
- AVANT de connecter les fils d'enceintes du cordon d'alimentation aux enceintes, vérifiez le câblage des enceintes de votre voiture.

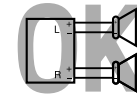

INSTALLATION / INSTALACION / INSTALLATION

The following illustration shows a typical installation. If you have any questions or require information regarding installation kits, consult your JVC car audio dealer or a company supplying kits.

La siguiente ilustración muestra una instalación típica. Si tiene alguna pregunta o necesita información acerca de las herramientas para instalación, consulte con su concesionario de JVC de equipos de audio para automóviles o a una compañía que suministra tales herramientas.

L'illustration suivante est un exemple d'installation typique. Si vous avez des questions ou avez besoin d'information sur des kits d'installation, consulter votre revendeur d'autoradios JVC ou une compagnie d'approvisionnement.

In-dash mounting / Montaje en el tablero / Montage encastré

1 Do the required electrical connections. / Realice las conexiones eléctricas requeridas. / Réalisez les connexions électriques.

Install the unit at an angle of less than 30°. / Instale la unidad a un ángulo de menos de 30°. / Installez l'appareil avec un angle de moins de 30°.

Bend the appropriate tabs to hold the sleeve firmly in place. / Doble las lengüetas apropiadas para retener firmemente la manga en su lugar. / Tordez les languettes appropriées pour maintenir le manchon en place.

Part list / Lista de componentes / Liste de pièces

- (A) Hard case (for KD-R618/KD-A615) / Estuche duro (para KD-R618/KD-A615) / Etui de transport (pour le KD-R618/KD-A615) (x1)
- (B) Control panel / Panel de control / Panneau de commande (x1)
- (C) Sleeve / Cubierta / Manchon (x1)
- (D) Trim plate / Placa de guarnición / Plaque d'assemblage (x1)
- (E) Power cord / Cordón de alimentación / Cordon d'alimentation (x1)
- (F) Handles / Manijas / Poignées (x2)

When installing the unit without using the sleeve / Instalación de la unidad sin utilizar la cubierta / Lors de l'installation de l'appareil sans utiliser de manchon

Flat head screws—M5 × 8 mm (M5 × 3/8") / Tornillos de cabeza plana—M5 × 8 mm (M5 × 3/8 pulgada) / Vis à tête plate—M5 × 8 mm (M5 × 3/8 pouces) *2

Pocket / Compartimiento / Poche

Bracket / Ménsula / Support *2

Removing the unit / Extracción de la unidad / Retrait de l'appareil

Release the rear section first... / Primero libere la sección trasera... / Ouvrez la section arrière en premier...

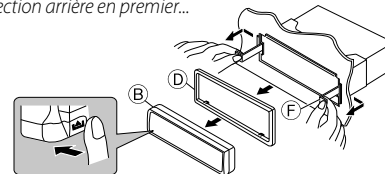

- *1 When you stand the unit, be careful not to damage the fuse on the rear. / Al poner la unidad vertical, tenga cuidado de no dañar el fusible provisto en la parte posterior. / Lorsque vous mettez l'appareil à la verticale, faire attention de ne pas endommager le fusible situé sur l'arrière.
- *2 Not supplied for this unit. / No suministrado con esta unidad. / Non fourni avec cet appareil.

TROUBLESHOOTING / LOCALIZACION DE AVERIAS / EN CAS DE DIFFICULTES

- The fuse blows.** ⇒ Are the red and black leads connected correctly?
- Power cannot be turned on.** ⇒ Is the yellow lead connected?
- No sound from the speakers.** ⇒ Is the speaker output lead short-circuited?
- "PROTECT" appears on the display and no operation can be done.** ⇒ Is the speaker output lead short-circuited or touches the chassis of the car/head unit? / Have you reset your unit?
- Sound is distorted.** ⇒ Is the speaker output lead grounded? / Are the "-" terminals of L and R speakers grounded in common?
- Noise interfere with sounds.** ⇒ Is the rear ground terminal connected to the car's chassis using shorter and thicker cords?
- This unit becomes hot.** ⇒ Is the speaker output lead grounded? / Are the "-" terminals of L and R speakers grounded in common?
- This unit does not work at all.** ⇒ Have you reset your unit?
- El fusible se quema.** ⇒ ¿Están los conductores rojo y negro correctamente conectados?
- No es posible conectar la alimentación.** ⇒ ¿Está el cable amarillo conectado?
- No sale sonido de los altavoces.** ⇒ ¿Está el cable de salida del altavoz cortocircuitado?
- Aparece "PROTECT" en la pantalla y no se puede realizar ninguna operación.** ⇒ ¿El conductor de salida de altavoz está en cortocircuito o en contacto con el chasis del automóvil/auriculares? / ¿Reinicializó la unidad?
- El sonido presenta distorsión.** ⇒ ¿Está el cable de salida del altavoz conectado a masa? / ¿Están los terminales "-" de los altavoces L y R conectados a una masa común?
- Perturbación de ruido.** ⇒ ¿El terminal de tierra trasero está conectado al chasis del automóvil utilizando los cordones más corto y más grueso?
- Esta unidad se calienta.** ⇒ ¿Está el cable de salida del altavoz conectado a masa? / ¿Están los terminales "-" de los altavoces L y R conectados a una masa común?
- Esta unidad no funciona en absoluto.** ⇒ ¿Reinicializó la unidad?
- Le fusible saute.** ⇒ Les fils rouge et noir sont-ils raccordés correctement?
- L'appareil ne peut pas être mise sous tension.** ⇒ Le fil jaune est-elle raccordée?
- Pas de son des enceintes.** ⇒ Le fil de sortie d'enceinte est-il court-circuité?
- "PROTECT" apparaît sur l'affichage et aucune opération ne peut être réalisée.** ⇒ Est-ce qu'un fil de sortie d'enceinte est court-circuité ou touche le châssis de la voiture/appareil principal? / Avez-vous réinitialisé votre appareil?
- Le son est déformé.** ⇒ Le fil de sortie d'enceinte est-il à la masse? / Les bornes "-" des enceintes gauche et droit sont-elles mises ensemble à la masse?
- Interférence avec les sons.** ⇒ La prise arrière de mise à la terre est-elle connectée au châssis de la voiture avec un cordon court et épais?
- Cet appareil devient chaud.** ⇒ Le fil de sortie d'enceinte est-il à la masse? / Les bornes "-" des enceintes gauche et droit sont-elles mises ensemble à la masse?
- Cet appareil ne fonctionne pas du tout.** ⇒ Avez-vous réinitialisé votre appareil?

Connecting the external amplifiers or subwoofer / Conexión de los amplificadores o subwoofer externos / Connexion d'amplificateurs extérieurs ou d'un caisson de grave

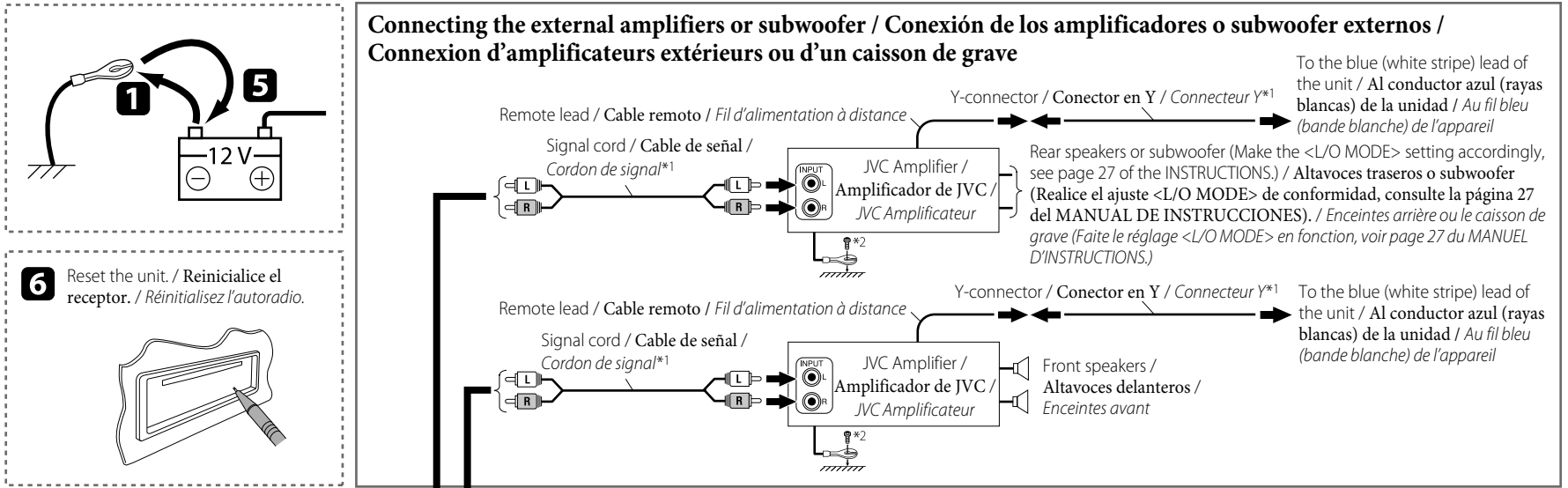

6 Reset the unit. / Reinicialice el receptor. / Réinitialisez l'autoradio.

IMPORTANT: A custom wiring harness (separately purchased) which is suitable for your car is recommended for connection between the unit and your car.
 • Consult your JVC car audio dealer or a company supplying kits for details.
IMPORTANTE: Para la conexión entre la unidad y su vehículo, se recomienda utilizar un mazo de cables personalizado (vendido separadamente) que sea adecuado para su vehículo.
 • Si desea información más detallada, consulte con su distribuidor de equipos de Car audio JVC o con una compañía proveedora de kits.
IMPORTANT: Un faisceau de câbles personnalisé (vendu séparément) correspondant à votre voiture est recommandé pour raccorder l'appareil et votre voiture.
 • Pour en savoir plus, consultez votre revendeur autoradio JVC ou une compagnie fournissant des kits.

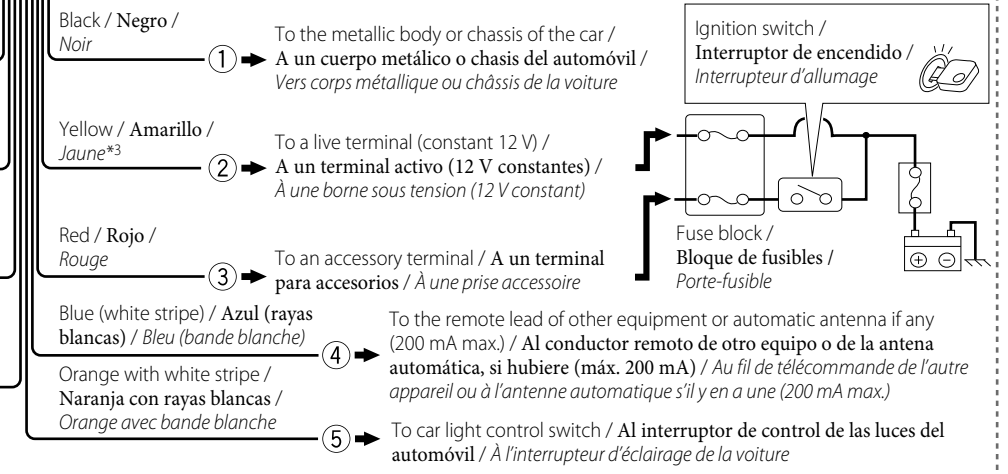
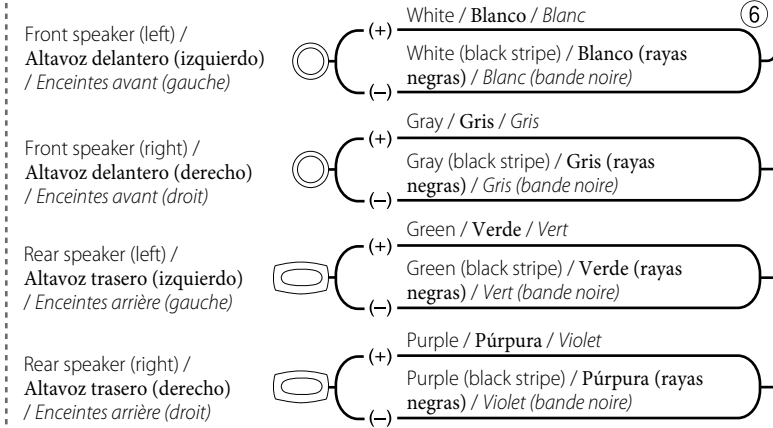
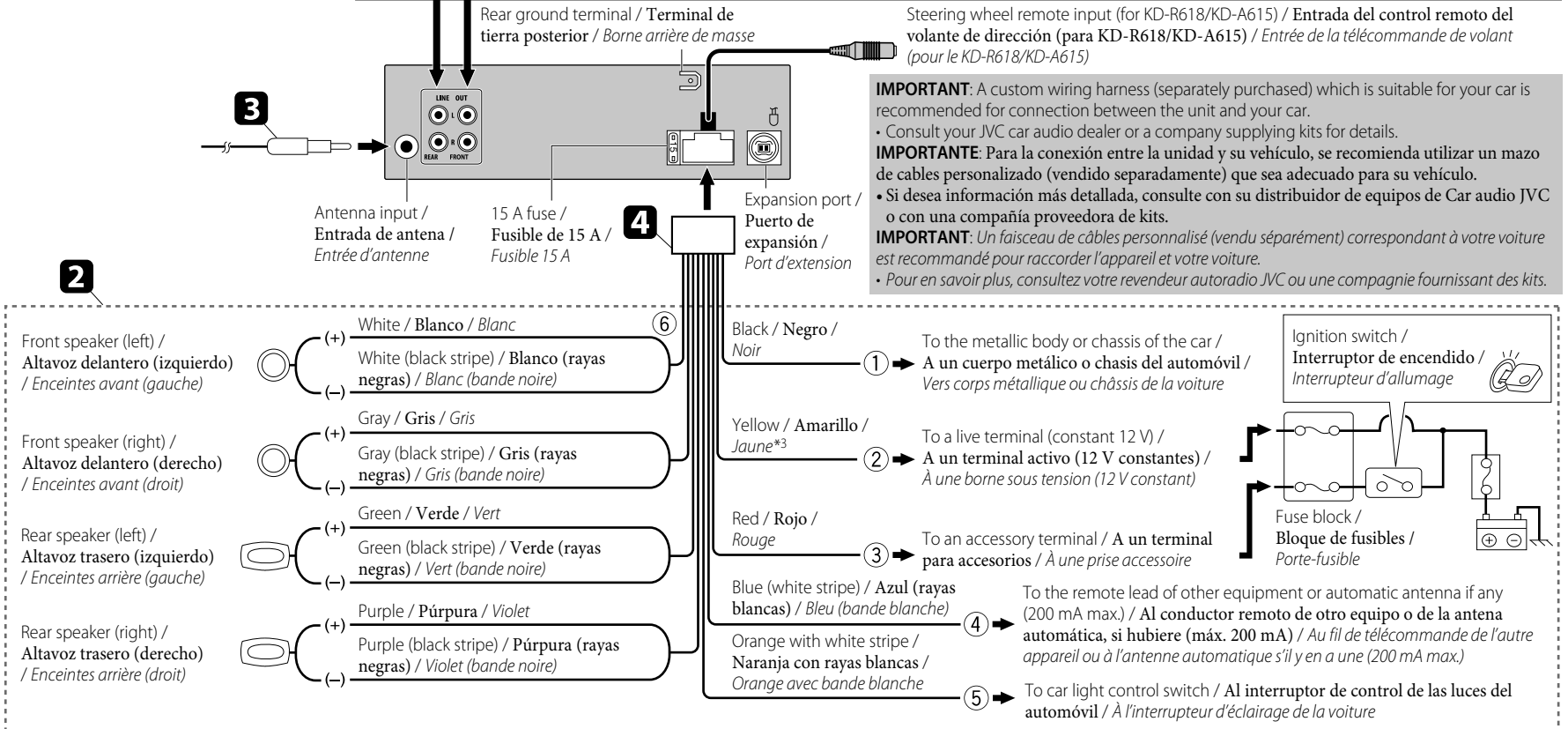

Connecting the external components in series / Conexión de componentes externos en serie / Connexion d'appareils extérieurs en série

When connecting the external components, refer also to the manuals supplied for the components and adapter. / Cuando conecte componentes externos, consulte, también, los manuales suministrados con los componentes y el adaptador. / Lors de la connexion des appareils extérieurs, référez-vous aussi aux manuels fournis avec les appareils et les adaptateurs.

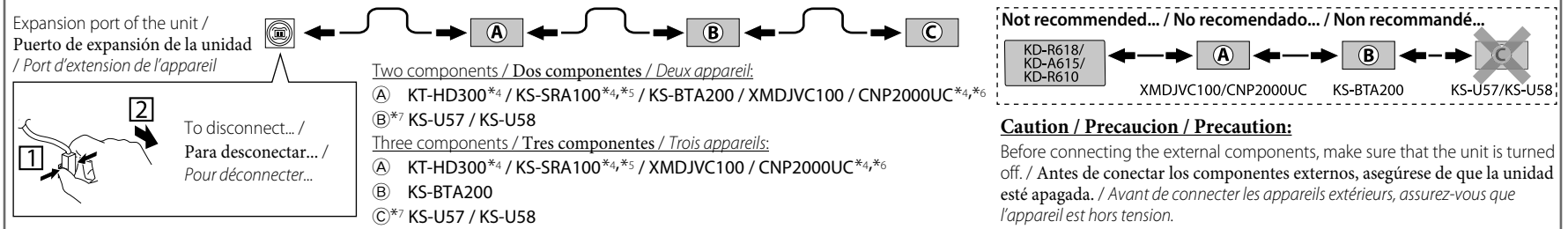

You can connect the HD Radio™ tuner box (KT-HD300) or the following components through the various JVC adapters or system to the expansion port. / Puede conectar el sintonizador HD Radio™ (KT-HD300) o los siguientes componentes al puerto de expansión, a través de los diversos adaptadores o sistema JVC. / Vous pouvez connecter le tuner HD Radio™ (KT-HD300) ou les appareils suivants à l'aide de divers adaptateur JVC ou système au port d'extension.

• Connection cords may need to be purchased separately. / Puede ser necesario comprar los cables de conexión por separado. / Vous pouvez avoir besoin d'acheter certains cordons de connexion séparément.

Component / Componente / Appareil	Adapter/System / Adaptador/Sistema / Adaptateur/Système	Model name / Nombre del modelo / Nom du modèle
Bluetooth device / Dispositivo Bluetooth / Périphérique Bluetooth	Bluetooth adapter / Adaptador Bluetooth / Adaptateur Bluetooth	KS-BTA200
XMDirect™ Tuner Box / XMDirect™ Tuner Box / XMDirect™ Tuner Box	Smart Digital Adapter / Adaptador digital inteligente / Adaptateur numérique intelligent	XMDJVC100
XMDirect2 Tuner System / Sistema de sintonizador XMDirect2 / XMDirect2 Tuner System	XM satellite radio System / Sistema de radio XM Satellite / Système radio satellite XM	CNP2000UC, CNPJVC1
SIRIUS satellite radio / Radio por satélite SIRIUS / Radio satellite SIRIUS	SIRIUS satellite radio System / Sistema de radio satelital SIRIUS / Système radio satellite SIRIUS	SC-C1, KS-SRA100 PnP, SC-VDOC1, KS-SRA100
Portable audio player with line output jacks / Reproductor de audio portátil con jacks de salida de línea / Lecteur audio portable avec prises de sortie de ligne	Line input adapter / Adaptador de entrada por línea / Adaptateur d'entrée de ligne	KS-U57
Portable audio player with 3.5 mm (3/16") stereo mini jack / Reproductor de audio portátil con jack mini estéreo de 3,5 mm (3/16 pulgada) / Lecteur audio portable avec mini fiche stéréo de 3,5 mm (3/16 pouces)	AUX input adapter / Adaptador de entrada AUX / Adaptateur d'entrée auxiliaire	KS-U58

XM Radio and SIRIUS satellite radio cannot be used together. / No puede utilizar juntas la radio XM y la radio satelital SIRIUS. / La radio XM et SIRIUS ne peuvent pas être utilisées en même temps.
 • HD Radio™ is a proprietary trademark of iBiquity Digital Corp. / HD Radio™ es una marca comercial de iBiquity Digital Corp. / HD Radio™ est une marque de commerce d'iBiquity Digital Corp.

*1 Not supplied for this unit. / No suministrado con esta unidad.
 *2 Firmly attach the ground wire to the metallic body or to the chassis of the car—to the place uncoated with paint. / Fije firmemente el cable de tierra a la carrocería metálica o al chasis—a un lugar no cubierto con pintura.
 *3 Before checking the operation of this unit prior to installation, this lead must be connected; otherwise, the power cannot be turned on. / Antes de comprobar el funcionamiento de esta unidad previa a de la instalación, es necesario conectar este cable, de lo contrario no se podrá conectar la alimentación.
 *4 Connect the power cord supplied for the component separately for power supply. / Conecte el cable de alimentación suministrado separadamente para el componente.
 *5 This model is a component of SIRIUS satellite radio System. / Este modelo es un componente del sistema de radio satelital SIRIUS.
 *6 This model is a component of XM satellite radio System. / Este modelo es un componente del sistema de radio XM Satellite.
 *7 To use these components, set the external input setting correctly (see page 28 of the INSTRUCTIONS). / Para utilizar estos componentes, configure el ajuste de entrada externa correctamente (consulte la página 28 del MANUAL DE INSTRUCCIONES).

JVC

ENGLISH

ไทย

KD-R616

CD RECEIVER / เครื่องเล่น CD

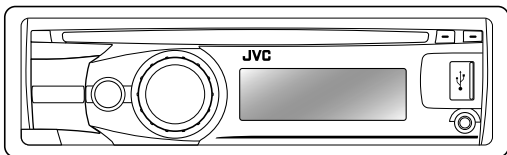
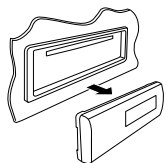

MP3
WMA



For canceling the display demonstration, see page 4. / ดูที่หน้า 4 เพื่อยกเลิกการสาธิตภาพประกอบ

For installation and connections, refer to the separate manual.

กรุณาดูคู่มือที่แยกต่างหาก ในการติดตั้งและการเชื่อมต่อ

INSTRUCTIONS

คำแนะนำ

GET0639-001A
[U/UH]

Thank you for purchasing a JVC product.

Please read all instructions carefully before operation, to ensure your complete understanding and to obtain the best possible performance from the unit.

IMPORTANT FOR LASER PRODUCTS

1. CLASS 1 LASER PRODUCT

2. **CAUTION:** Do not open the top cover. There are no user serviceable parts inside the unit; leave all servicing to qualified service personnel.

3. **CAUTION:** Visible and/or invisible class 1M laser radiation when open. Do not view directly with optical instruments.

4. REPRODUCTION OF LABEL: CAUTION LABEL, PLACED OUTSIDE THE UNIT.

CAUTION VISIBLE AND/OR INVISIBLE CLASS 1M LASER RADIATION WHEN OPEN. DO NOT VIEW DIRECTLY WITH OPTICAL INSTRUMENTS. IEC60825-1:2001 (ENG)	ATTENTION RAYONNEMENT LASER VISIBLE ET/OU INVISIBLE DE CLASSE 1M LORS QU'EST NE PAS REGARDER DIRECTEMENT AVEC DES INSTRUMENTS OPTIQUES. (FRA)	AVISO RADIACION LASER DE CLASE 1M VISIBLE Y/O INVISIBLE CUANDO ESTA ABIERTO. NO MIRAR DIRECTAMENTE CON INSTRUMENTAL OPTICO. (ESP)	VARNING SYNLIG OCH/ELLER OSYNLIG LASERSTRÅLNING KLASS 1M, NÄR DENNA DEL ÄR ÖPPNAD. BETRÄKTA EJ STRÅLEN MED OPTISKA INSTRUMENT. (SWE)	注意 ここを開くと可視 及びまたは不可視 のクラス1M レーザー放射が 出ます。 光学機器で直接 見ないでください。 (JPN)	CAUTION VISIBLE AND/OR INVISIBLE CLASS 1 LASER RADIATION WHEN OPEN. DO NOT STARE INTO BEAM. FDA 21 CFR (ENG)
--	---	---	--	---	---



[European Union only]

Warning:

If you need to operate the unit while driving, be sure to look around carefully or you may be involved in a traffic accident.

For safety...

- Do not raise the volume level too much, as this will block outside sounds, making driving dangerous.
- Stop the car before performing any complicated operations.

Temperature inside the car...

If you have parked the car for a long time in hot or cold weather, wait until the temperature in the car becomes normal before operating the unit.

How to read this manual

The following icons/symbols are used to indicate:



[Hold]

Press and hold the button(s) until the desired operation begins.



Turn the control dial.



Turn the control dial to make a selection, then press to confirm.



Reference page number



Menu setting item



Continued on the next page

How to attach/detach the control panel

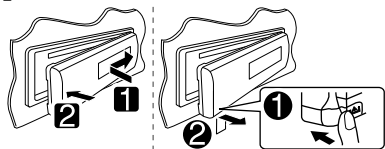

How to reset your unit

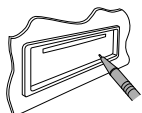

Your preset adjustments will also be erased (except the registered Bluetooth device). (🔍 11)

How to forcibly eject a disc

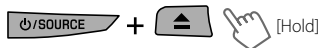

- You can forcibly eject the loaded disc even if the disc is locked. To lock/unlock the disc, (🔍 9).
- Be careful not to drop the disc when it ejects.
- If this does not work, reset your unit.

CONTENTS

- 2 How to read this manual
- 3 How to attach/detach the control panel
- 3 How to reset your unit
- 3 How to forcibly eject a disc
- 4 Canceling the display demonstration
- 4 Setting the clock
- 5 Preparing the remote controller (RM-RK50)
- 6 Basic operations
- 7 Listening to the radio
- 9 Listening to a disc
- 10 Listening to the USB device
- 11 Using Bluetooth® devices
 - 13 Using a Bluetooth mobile phone
 - 14 Using a Bluetooth audio player
- 16 Listening to the iPod/iPhone
- 18 Listening to the other external components
- 19 Selecting a preset sound mode
- 20 Menu operations
- 26 More about this unit
- 29 Maintenance
- 30 Troubleshooting
- 34 Specifications

Canceling the display demonstration

1 Turn on the power.



2 MENU [Hold]



4 Select <DEMO OFF>.



6 Finish the procedure.



Setting the clock

1 Turn on the power.



2 MENU [Hold]



3 Select <CLOCK>.



4 Select <CLOCK SET>.



5 Adjust the hour.



6 Adjust the minute.



7 Finish the procedure.



Preparing the remote controller (RM-RK50)

When you use the remote controller for the first time, pull out the insulation sheet.

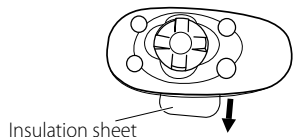

If the effectiveness of the remote controller decreases, replace the battery.

Replacing the lithium coin battery

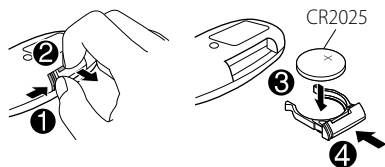

Caution:

- Danger of explosion if battery is incorrectly replaced. Replace only with the same or equivalent type.
- Battery shall not be exposed to excessive heat such as sunshine, fire, or the like.

Warning (to prevent accidents and damage):

- Do not install any battery other than CR2025 or its equivalent.
- Do not leave the remote controller in a place (such as dashboards) exposed to direct sunlight for a long time.
- Store the battery in a place where children cannot reach.
- Do not recharge, short, disassemble, heat the battery, or dispose of it in a fire.
- Do not leave the battery with other metallic materials.
- Do not poke the battery with tweezers or similar tools.
- Wrap the battery with tape and insulate when throwing away or saving it.

This unit is equipped with the steering wheel remote control function.







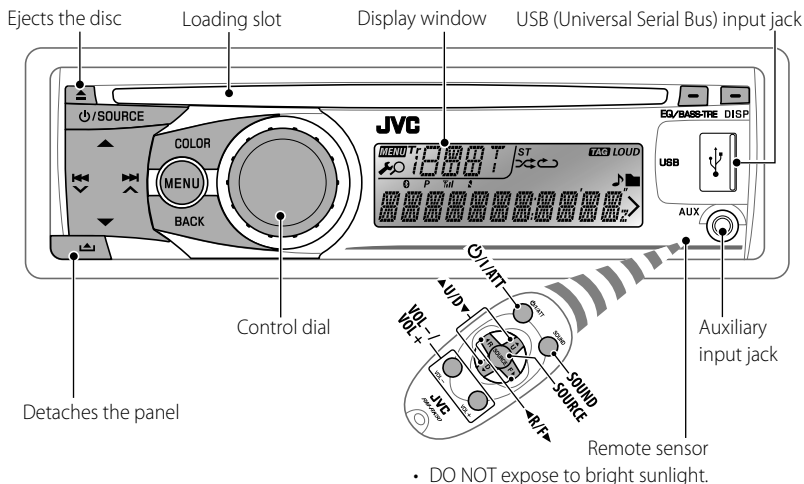

Before operating, connect an exclusive remote adapter (not supplied) which matches your car to the steering wheel remote input terminal on the rear of the unit.



- For details, refer also to the instructions supplied with the remote adapter.
-

Basic operations





When you press or hold the following button(s)...



Main unit	Remote controller	General operation
		Turns on. • When the power is on, pressing POWER/ATT on the remote controller also mutes the sound or pauses. Press POWER/ATT again to cancel muting or resume playback. Turns off if pressed and held.
		Selects the available sources (if the power is turned on). • If the source is ready, playback also starts.
		Adjusts the volume level.
	—	Selects items.
	—	• Mutes the sound while listening to a source. If the source is “CD,” “USB” or “USB-IPOD,” playback pauses. Press the control dial again to cancel muting or resume playback. • Confirms selection.
		Selects the sound mode. • Enters tone level adjustment directly ( 19) if pressed and held EQ/BASS-TRE on the main unit.

Main unit	Remote controller	General operation
	—	<ul style="list-style-type: none"> Enters <COLOR> setting directly (📺 24). Enters <COLOR SETUP> setting directly (📺 25) if pressed and held.
	—	Returns to the previous menu.
	—	<p>Power off : Checks the current clock time.</p> <p>Power on : Changes the display information.</p>

Listening to the radio



1  

⇒ "FM" or "AM"

2  

"ST" lights up when receiving an FM stereo broadcast with sufficient signal strength.



Manual search

  "M" flashes, then press the button repeatedly.

[Hold]

When an FM stereo broadcast is hard to receive

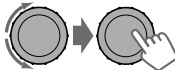
1   [Hold]

2  

⇒ <TUNER> ⇒ <MONO> ⇒
<MONO ON>

Reception improves, but stereo effect will be lost.

To restore the stereo effect, repeat the same procedure to select <MONO OFF>.



Automatic presetting (FM)—

SSM (Strong-station Sequential Memory)

You can preset up to 18 stations for FM.

While listening to a station...

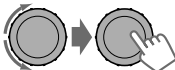
1   [Hold]

2  

⇒ <TUNER> ⇒ <SSM> ⇒
<SSM 01 - 06> / <SSM 07 - 12> /
<SSM 13 - 18>

"SSM" flashes and local stations with the strongest signals are searched and stored automatically.

To preset another 6 stations, repeat the above procedure by selecting one of the other 6 SSM setting ranges.



Manual presetting (FM/AM)

You can preset up to 18 stations for FM and 6 stations for AM.

Ex: Storing FM station of 92.50 MHz into preset number "04."

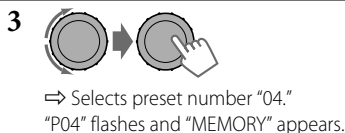
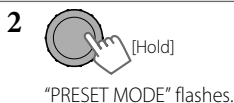

Selecting a preset station

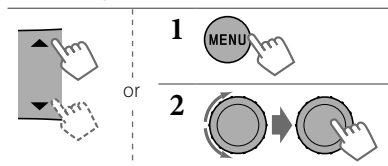

Changing the display information

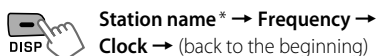

* If no title is assigned to a station, "NO NAME" appears for a few seconds.

Using the remote controller

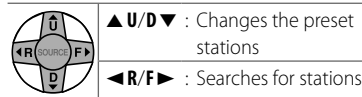

Title assignment

You can assign titles up to 30 station frequencies (FM and AM) using 8 characters (maximum) for each title.

- If you try to assign titles to more than 30 station frequencies, "NAME FULL" appears. Delete unwanted titles before assignment.

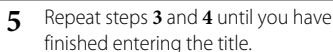
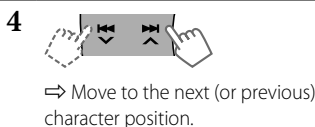
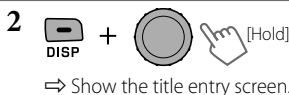

To erase the entire title, press and hold **DISP** after step 2, then press the control dial.

Available characters

A	B	C	D	E	F	G	H	I
J	K	L	M	N	O	P	Q	R
S	T	U	V	W	X	Y	Z	0
1	2	3	4	5	6	7	8	9
—	/	<	>	Space				

Listening to a disc

1



⇒ Turn on the power.

2

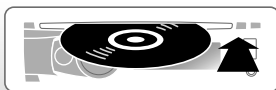

All tracks will be played repeatedly until you change the source or eject the disc.

Stopping playback and ejecting the disc



"NO DISC" appears.

Press **POWER/SOURCE** to listen to another playback source.

Prohibiting disc ejection



To cancel the prohibition, repeat the same procedure.

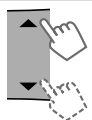

Selects folder of the MP3/WMA



Selects track



Fast-forwards or reverses the track

[Hold]

Selecting a track/folder

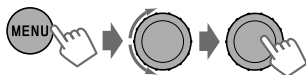

For MP3/WMA discs, select the desired folder, then the desired track by repeating the control dial procedures.

- If the MP3/WMA disc contains many tracks, you can fast search (± 10 , ± 100 , ± 1000) through the disc by turning the control dial quickly.
- To return to the previous menu, press **BACK**.

Caution on volume setting:

Discs produce very little noise compared with other sources. Lower the volume before playing a disc to avoid damaging the speakers by the sudden increase of the output level.

Selecting the playback modes

You can use only one of the following playback modes at a time.

1



2

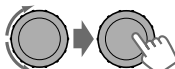

⇒ "REPEAT" ↔ "RANDOM"

3

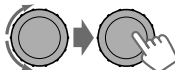

REPEAT

TRACK RPT : Repeats current track

FOLDER RPT : Repeats current folder

RANDOM

FOLDER RND: Randomly plays all tracks of current folder, then tracks of next folders

ALL RND : Randomly plays all tracks

To cancel repeat play or random play, select "RPT OFF" or "RND OFF."



Changing the display information



Disc title/Album name/performer (folder name)* → Track title (file name)* → Current track number with the elapsed playing time → Current track number with the clock time → (back to the beginning)

* If the current disc is an audio CD, "NO NAME" appears.

If an MP3/WMA file does not have Tag information or <TAG DISPLAY> is set to <TAG OFF> (🔍 20), folder name and file name appear.

Using the remote controller



▲ U/D ▼ : Selects folder of the MP3/WMA

◀ R/F ▶ : Selects track

◀ R/F ▶ : Fast-forwards or [Hold] reverses the track

Listening to the USB device

This unit can play MP3/WMA files stored on a USB mass storage class device.

You can connect a USB mass storage class device such as a USB memory, Digital Audio Player, etc. to the unit.

- You can also connect an Apple iPod/iPhone to the USB input jack. For details of the operations, 🔍 16 – 17.

1



⇒ Turn on the power.

2

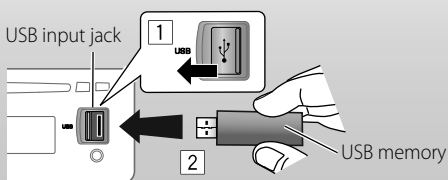

All tracks will be played repeatedly until you change the source or detach the USB device.

Caution on volume setting:

USB devices produce very little noise compared with other sources. Lower the volume before playing a USB to avoid damaging the speakers by sudden increase of the output level.

If you have turned off the power (without detaching the USB device)...

Pressing **🔌/SOURCE** turns on the power and playback starts from where it has been stopped previously.

- If a different USB device is currently attached, playback starts from the beginning.

Stop playing and detaching the USB device

Straightly pull it out from the unit. "NO USB" appears. Press **🔌/SOURCE** to listen to another playback source.

You can operate the USB device in the same way you operate the files on a disc. (🔍 9)

Cautions:

- Avoid using the USB device if it might hinder your safety driving.
- Do not pull out and attach the USB device repeatedly while "READING" is shown on the display.
- Do not start the car engine if a USB device is connected.
- This unit may not be able to play the files depending on the type of USB device.
- Operation and power supply may not work as intended for some USB devices.

- You cannot connect a computer to the USB input terminal of the unit.
- Make sure all important data has been backed up to avoid losing the data.
- Do not leave a USB device in the car, expose to direct sunlight, or high temperature to avoid deformation or cause damages to the device.
- Some USB devices may not work immediately after attaching USB device or turn on the power.
- For more details about USB operations,  27, 28.

Using Bluetooth® devices

For Bluetooth operations, it is required to connect the Bluetooth adapter, KS-BTA200 (not supplied) to the expansion port on the rear of this unit.

- Refer to pages **i** and **ii** at the end of the manual to check the countries where you may use the Bluetooth® function.
- For details, refer also to the instructions supplied with the Bluetooth adapter and the Bluetooth device.

To use a Bluetooth device through the unit ("BT-PHONE" and "BT-AUDIO") for the first time, you need to establish a Bluetooth wireless connection between the unit and the device.

- Once the connection is established, it is registered on the unit even if you reset your unit. Up to five devices can be registered in total.
- Only one device can be connected at a time for each source ("BT-PHONE" and "BT-AUDIO").

Registration (Pairing) methods

Use either of the following items ("OPEN" or "SEARCH") in the Bluetooth menu to register and make the unit ready to establish a new Bluetooth connection with a device.

"OPEN" : Connection is established by operating the Bluetooth device.

"SEARCH" : Connection is established by operating the unit.

Registering using "OPEN"

Preparation: Operate the device to turn on its Bluetooth function.



⇒ "BT-PHONE" or "BT-AUDIO"



⇒ "NEW DEVICE" ⇒ "OPEN"



⇒ Enter a PIN (Personal Identification Number) code in to the unit.

You can enter any number you like (1-digit to 16-digit number).

[Initial: 0000]

- Some devices have their own PIN code. Enter the specified PIN code in to the unit.



4 Repeat step 3 on page 11 until you have finished entering the PIN code.



"OPEN.." flashes.

6 Use the Bluetooth device to search and connect.

On the device to be connected, enter the same PIN code you have just entered for this unit. "CONNECTED" appears.

Now connection is established and you can use the device through the unit.

The device remains registered even after you disconnect the device. Use "CONNECT" (or activate "AUTO CNNECT") to connect the same device from next time on. (🔍 15)

Registering using "SEARCH"/"SPECIAL"



⇒ "BT-PHONE" or "BT-AUDIO"



⇒ "NEW DEVICE"



⇒ "SEARCH" : To search for available devices

The unit searches and displays the list of the available devices. "UNFOUND" appears if no available device is detected.

----- or -----

⇒ "SPECIAL" : To connect a special device

The unit displays the list of the preset devices.



⇒ Select a device you want to connect.

5 **For available devices...**

⇒ Enter the specific PIN code of the device to the unit.

- Refer to the instructions supplied with the device to check the PIN code. Use the Bluetooth device to connect. Now connection is established and you can use the device through the unit.

For special device...

Use "OPEN" or "SEARCH" to connect.

Connecting/disconnecting/ deleting a registered device



⇒ "BT-PHONE" or "BT-AUDIO"



⇒ Select a device you want to connect/disconnect/delete.



⇒ "CONNECT" or "DISCONNECT" : To connect/disconnect the selected device

----- or -----

⇒ "DELETE" ⇒ "YES" : To delete the selected device

You can set the unit to connect the Bluetooth device automatically when the unit is turned on. ("AUTO CNNECT," 🔍 15)

Using a Bluetooth mobile phone

-  ⇒ "BT-PHONE"
-  ⇒ Bluetooth menu
- Make a call or setting using the Bluetooth setting menu.** (🔍 15)



When a call comes in....

The source is automatically changed to "BT-PHONE."

- The display will flash in blue. (<RING COLOR>, 🔍 21)

When "AUTO ANSWER" is activated....

The unit answers the incoming calls automatically. (🔍 15)

- When "AUTO ANSWER" is deactivated, press any button (except  / **SOURCE** /  / ) to answer the incoming call.
- You can adjust the microphone volume level. (🔍 15)

To end the call

Hold any button (except  / **SOURCE** /  / ).

When a text message comes in....





If the mobile phone is compatible with text message (notified through JVC Bluetooth adapter) and "MSG INFO" (message info) is set to "AUTOMATIC" (🔍 15), the unit rings to inform you of the message arrival.

- "RCV MESSAGE" (receiving message) appears and the display illuminate in blue. (<RING COLOR>, 🔍 21)

Using the remote controller

	▲ U/D ▼ / : Answers calls ◀ R/F ▶ / SOURCE
	▲ U/D ▼ / : Rejects calls ◀ R/F ▶ / SOURCE [Hold]

Making a call

-  ⇒ "BT-PHONE"
- 
-  ⇒ Select "DIAL" menu.
-  ⇒ Select a calling method.
**PHONE BOOK* ↔ MISSED* ↔
NUMBER ↔ VOICE DIAL ↔
REDIAL* ↔ RECEIVED* ↔** (back to the beginning)
** Displays only when your mobile phone is equipped with these functions and is compatible with this unit.*



5 For REDIAL, RECEIVED, MISSED

⇒ Repeat step 4 on page 13 to select a name (if it is acquired) or a phone number.

For PHONE BOOK

⇒ Repeat step 4 on page 13 to select a name or a phone number.

For NUMBER



⇒ Enter a phone number.

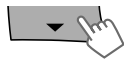

⇒ Confirm.

For VOICE DIAL

⇒ Speak the name you want to call when "SAY NAME" appears.

- If your mobile phone does not support the voice recognition system, "ERROR" appears.
- Using voice tags may be difficult in a noisy environment or during an emergency.

• To return to the previous menu, press ▲.

Using a Bluetooth audio player



⇒ "BT-AUDIO"

If playback does not start, operate the Bluetooth audio player to start playback. Operate the Bluetooth audio player to pause (if playback does not pause when you change the source).



Reverse skips/forward skips



Pauses/starts playback*

* Operation may be different according to the connected Bluetooth audio player.



Enter setting menu (Device list)

For connecting/disconnecting/deleting a registered device, 12.

Using the remote controller



◀R/F▶ : Reverse skips/forward skips

Changing the Bluetooth settings



⇒ "BT-PHONE" or "BT-AUDIO"



⇒ Bluetooth menu



⇒ "SETTINGS"



⇒ Select a setting item.

AUTO CNNECT ↔ **AUTO ANSWER***1

↔ **MSG INFO***2 ↔ **MIC SETTING***1

↔ **VERSION***3 ↔ (back to the beginning)

5



- *1 *Appears only when a Bluetooth phone is connected.*
- *2 *Appears only when a Bluetooth phone is connected and it is compatible with text message (notified through JVC Bluetooth adapter).*
- *3 *Bluetooth Audio: Shows only "Version."*

Setting menu [Initial: Underlined]

AUTO CNNECT (connect)

When the unit is turned on, the connection is established automatically with...

OFF: No Bluetooth device.

LAST: The last connected Bluetooth device.

ORDER: The available registered Bluetooth device found at first.

AUTO ANSWER

Only for the device being connected for "BT-PHONE."

ON: The unit answers the incoming calls automatically.

OFF: The unit does not answer the calls automatically. Answer the calls manually.

REJECT: The unit rejects all incoming calls.

MSG INFO (message info)

Only for the device being connected for "BT-PHONE."

AUTOMATIC: The unit informs you of the arrival of a message by ringing and displaying "RCV MESSAGE" (receiving message).

- The display illuminate in blue. (<RING COLOR>, [M] 21)

MANUAL: The unit does not inform you of the arrival of a message.

MIC SETTING (microphone setting)

Only for the device being connected for "BT-PHONE." Adjust microphone volume connected to the Bluetooth adapter, [LEVEL 01/02/03].

VERSION

The Bluetooth software and hardware versions are shown.

Warning messages

ERROR CNNECT (Error Connection)

The device is registered but the connection has failed. Use "CONNECT" to connect the device again. ([M] 12)

ERROR

Try the operation again. If "ERROR" appears again, check if the device supports the function you have tried.

UNFOUND

No available Bluetooth device is detected by "SEARCH."

LOADING*

The unit is updating the phone book.

PLEASE WAIT

The unit is preparing to use the Bluetooth function. If the message does not disappear, turn off and turn on the unit, then connect the device again (or reset the unit).

RESET 8

Check the connection between the adapter and this unit.

**Displays only when your mobile phone is equipped with these functions and is compatible with this unit.*

Bluetooth Information:

If you wish to receive more information about Bluetooth, visit the following JVC web site: <<http://www.jvc.co.jp/english/car/>> (English website only)



Listening to the iPod/iPhone

You can connect the iPod/iPhone using the USB 2.0 cable (accessory of the iPod/iPhone) to the USB input jack on the control panel.

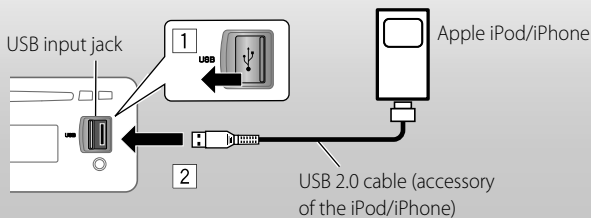

- Disconnecting the iPod/iPhone will stop playback. Press **⏪/SOURCE** to listen to another playback source.
- For details, refer also to the instructions supplied with your iPod/iPhone.

Caution:

- Avoid using the iPod/iPhone if it might hinder your safety while driving.
- Make sure all important data has been backed up to avoid losing the data.

There are two control terminals:

- <HEAD MODE> Control by this unit.
- <IPOD MODE> Control by the connected iPod/iPhone.

Preparation: Select the controlling terminal, <HEAD MODE> or <IPOD MODE> for iPod playback:

- Press and hold **BACK** button.
- Make the selection from <IPOD SWITCH> setting, 23.

The operations explained below are under <HEAD MODE>.

- 1** **⏪/SOURCE**
⇒ "USB-IPOD"
Playback starts automatically.
- 2**
⇒ Select a song.



Pauses or resumes playback



Selects track



Fast-forwards or reverses the track

[Hold]

Selecting a track from the menu

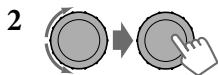

⇒ Select the desired menu.

PLAYLISTS ↔ ARTISTS ↔ ALBUMS

↔ SONGS ↔ PODCASTS ↔

GENRES ↔ COMPOSERS ↔

AUDIOBOOKS ↔ (back to the beginning)

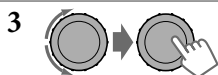

⇒ Select the desired track.

Repeat this procedure until the desired track is selected.

- If the selected menu contains many tracks, you can fast search (± 10 , ± 100 , ± 1000) through the menu by turning the control dial quickly.
- To return to the previous menu, press **BACK**.

Selecting the playback modes

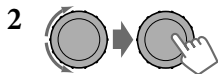

⇒ "REPEAT" ↔ "RANDOM"

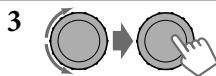

REPEAT

ONE RPT : Functions the same as "Repeat One" of the iPod

ALL RPT : Functions the same as "Repeat All" of the iPod

RANDOM

ALBUM RND : Functions the same as "Shuffle Albums" of the iPod

SONG RND : Functions the same as "Shuffle Songs" of the iPod

- To cancel repeat play or random play, select "RPT OFF" or "RND OFF."
- "ALBUM RND" is not available for some iPod.
- To return to the previous menu, press **BACK**.

Changing the display information



Album name/performer → Track title → Current track number with the elapsed playing time → Current track number with the clock time → (back to the beginning)

Using the remote controller



◀ **R/F** ▶ : Selects track

◀ **R/F** ▶ : Fast-forwards or reverses the track
[Hold]

Notice:

When operating an iPod, some operations may not be performed correctly or as intended. In this case, visit the following JVC web site: <<http://www.jvc.co.jp/english/car/>> (English website only)

Listening to the other external components

You can connect an external component to:

- **EXT INPUT:** Expansion port on the rear of this unit using the following adapters (not supplied):

- **KS-U57**, Line Input Adapter

- **KS-U58**, AUX Input Adapter



Preparation: Make sure <EXT ON> is selected for the <SRC SELECT> → <EXT IN> setting.

(🔍 23)

- **AUX IN:** AUX (auxiliary) input jack on the control panel.

Preparation: Make sure <AUX ON> is selected for the <SRC SELECT> → <AUX IN> setting. (🔍 23)

- For details, refer also to the instructions supplied with the adapter or external components.

- 1  ⇒ "EXT INPUT" or "AUX IN"
- 2 **Turn on the connected component and start playing the source.**
- 3  ⇒ Adjust the volume.
- 4 **Adjust the sound as you want.** (🔍 19)

Connecting an external component to the AUX input jack

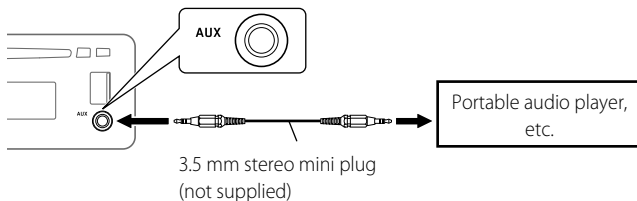

Selecting a preset sound mode

You can select a preset sound mode suitable for the music genre.



FLAT → **NATURAL** → **DYNAMIC** → **VOCAL BOOST** → **BASS BOOST** → **USER** → (back to the beginning)

While listening, you can adjust the tone level of the selected sound mode.

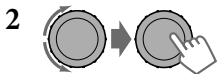

Adjust the level (-06 to +06) of the selected tone (BASS / MID / TRE).
The sound mode is automatically stored and changed to "USER."

Storing your own sound mode

You can store your own adjustments in memory.

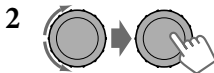

⇒ <PRO EQ> ⇒ <BASS> / <MIDDLE> / <TREBLE>

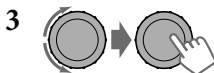

Adjust the sound elements of the selected tone. (🔍 table on the left)

4 Repeat steps 2 and 3 to adjust other tones.

The adjustments made will be stored automatically in "USER."

The current sound mode changes to "USER" automatically.

Tone	Sound element		
	Frequency	Level	Q
BASS	60 Hz	-06 to +06	Q1.0
	80 Hz		Q1.25
	100 Hz		Q1.5
	200 Hz		Q2.0
MIDDLE	0.5 kHz	-06 to +06	Q0.75
	1.0 kHz		Q1.0
	1.5 kHz		Q1.25
	2.5 kHz		
TREBLE	10.0 kHz	-06 to +06	Q FIX
	12.5 kHz		
	15.0 kHz		
	17.5 kHz		



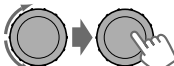

Menu operations

1  [Hold]	2 	3 Repeat step 2 if necessary. <ul style="list-style-type: none"> • To return to the previous menu, press BACK. • To exit from the menu, press DISP or MENU.
---	--	---

Category	Menu item	Selectable setting, [Initial: <u>Underlined</u>]
DEMO	DEMO Display demonstration	<ul style="list-style-type: none"> • <u>DEMO ON</u> : Display demonstration will be activated automatically if no operation is done for about 20 seconds. • <u>DEMO OFF</u> : Cancels. (🕒 4)
	CLOCK SET Clock setting	— : Adjust the hour, then the minute. (🕒 4) <u>[1:00]</u>
PRO EQ	BASS	— : For settings, 🕒 19.
	MIDDLE	
	TREBLE	
DISPLAY	DIMMER	<ul style="list-style-type: none"> • <u>DIMMER AUTO</u> : Dims the display when you turn on the headlights.*1 • <u>DIMMER ON</u> : Dims the display and button illumination. • <u>DIMMER OFF</u> : Cancels.
	SCROLL *2	<ul style="list-style-type: none"> • <u>SCROLL ONCE</u> : Scrolls the displayed information once. • <u>SCROLL AUTO</u> : Repeats scrolling (at 5-second intervals). • <u>SCROLL OFF</u> : Cancels. Pressing DISP for more than one second can scroll the display regardless of the setting.
	TAG DISPLAY	<ul style="list-style-type: none"> • <u>TAG ON</u> : Shows the Tag information while playing MP3/WMA tracks. • <u>TAG OFF</u> : Cancels.

*1 The illumination control lead connection is required. (See "Installation/Connection Manual.") This setting may not work correctly on some vehicles (particularly on those having a control dial for dimming). In this case, change the setting to any other than <DIMMER AUTO>.

*2 Some characters or symbols will not be shown correctly (or will be blanked) on the display.

Category	Menu item	Selectable setting, [Initial: <u>Underlined</u>]
TUNER	SSM *3 Strong-station Sequential Memory	<ul style="list-style-type: none"> • SSM 01 – 06 : For settings,  7. • SSM 07 – 12 • SSM 13 – 18
	MONO *3 Monaural mode	<ul style="list-style-type: none"> • MONO ON : Activate monaural mode to improve FM reception, but stereo effect will be lost. ( 7) • MONO OFF : Restore the stereo effect.
	IF BAND Intermediate frequency band	<ul style="list-style-type: none"> • AUTO : Increases the tuner selectivity to reduce interference noises between adjacent stations. (Stereo effect may be lost.) • WIDE : Subject to interference noises from adjacent stations, but sound quality will not be degraded and the stereo effect will remain.
COLOR	BUTTON ZONE	COLOR 01 — : For settings,  24. COLOR 29, USER
	DISP ZONE Display zone	
	ALL ZONE	
COLOR SETUP	DAY COLOR	<ul style="list-style-type: none"> • BUTTON ZONE : For settings,  25. • DISP ZONE
	NIGHT COLOR	
	MENU COLOR	<ul style="list-style-type: none"> • ON : Changes the display and buttons (except for EQ/BASS-TRE / DISP) illumination during menu, list search and playback mode operations. • OFF : Cancels.
	RING COLOR *4	<ul style="list-style-type: none"> • ON : When a call comes in, the display will flash in blue. <ul style="list-style-type: none"> • The display will change to the original color when the call is answered or the incoming call stops. When the unit receives a text message, the display only illuminate in blue. • OFF : Cancels.

*3 Displayed only when the source is "FM."

*4 Displayed only when Bluetooth adapter, KS-BTA200 is connected.



Category	Menu item	Selectable setting, [Initial: <u>Underlined</u>]
AUDIO	FADER * ⁵	R06 – F06 : Adjust the front and rear speaker output [00] balance.
	BALANCE * ⁶	L06 – R06 : Adjust the left and right speaker output [00] balance.
	LOUD Loudness	• LOUD ON : Boost low and high frequencies to produce a well-balanced sound at a low volume level. • <u>LOUD OFF</u> : Cancels.
	VOL ADJUST Volume adjust	VOL ADJ -05 — : Preset the volume adjustment level of VOL ADJ +05 each source (except FM), compared to the <u>VOL ADJ 00</u> FM volume level. The volume level will automatically increase or decrease when you change the source. • Before making an adjustment, select the source you want to adjust. • "VOL ADJ FIX" appears on the display if "FM" is selected as the source.
	L/O MODE Line output mode	• SUB.W : Select if the REAR LINE OUT terminals are used for connecting a subwoofer (through an external amplifier). • <u>REAR</u> : Select if the REAR LINE OUT terminals are used for connecting the speakers (through an external amplifier).
	SUB.W FREQ * ⁷ Subwoofer cutoff frequency	• LOW : Frequencies lower than 72 Hz are sent to the subwoofer. • <u>MID</u> : Frequencies lower than 111 Hz are sent to the subwoofer. • HIGH : Frequencies lower than 157 Hz are sent to the subwoofer.
	SUB.W LEVEL * ⁷ Subwoofer level	SUB.W 00 — : Adjust the subwoofer output level. SUB.W 08 <u>SUB.W 04</u>

*⁵ If you are using a two-speaker system, set the fader level to "00."

*⁶ This adjustment will not affect the subwoofer output.

*⁷ Displayed only when <L/O MODE> is set to <SUB.W>.

Category	Menu item	Selectable setting, [Initial: <u>Underlined</u>]
AUDIO	BEEP Keypress tone	<ul style="list-style-type: none"> • <u>BEEP ON</u> : Activates the keypress tone. • <u>BEEP OFF</u> : Deactivates the keypress tone.
	AMP GAIN *8 Amplifier gain control	<ul style="list-style-type: none"> • <u>LOW POWER</u> : VOLUME 00 – VOLUME 30 (Select if the maximum power of each speaker is less than 50 W to prevent damaging the speakers.) • <u>HIGH POWER</u> : VOLUME 00 – VOLUME 50
SRC SELECT	AM *9 AM station	<ul style="list-style-type: none"> • <u>AM ON</u> : Enable “AM” in source selection. • <u>AM OFF</u> : Disable “AM” in source selection.
	EXT IN *10 External input	<ul style="list-style-type: none"> • <u>EXT ON</u> : Enable “EXT IN” in source selection. • <u>EXT OFF</u> : Disable “EXT IN” in source selection.
	AUX IN *11 Auxiliary input	<ul style="list-style-type: none"> • <u>AUX ON</u> : Enable “AUX IN” in source selection. • <u>AUX OFF</u> : Disable “AUX IN” in source selection.
AUDIOBOOKS	AUDIOBOOKS *12 Speed control of “Audiobooks”	<ul style="list-style-type: none"> • <u>NORMAL</u> : You can select the playback speed of the “Audiobook” sound file in your iPod. • <u>FASTER</u> • <u>SLOWER</u> : Initial selected item depends on your iPod setting.
IPOD SWITCH	IPOD SWITCH *13 iPod/iPhone control	<ul style="list-style-type: none"> • <u>HEAD MODE</u> : Controls iPod playback through the unit. • <u>IPOD MODE</u> : Controls iPod playback through the iPod/iPhone.

*8 The volume level automatically changes to “VOLUME 30” if you change to <LOW POWER> with the volume level set higher than “VOLUME 30.”

*9 Displayed only when any source other than “AM” is selected.

*10 Displayed only when any source other than “EXT IN” is selected.

*11 Displayed only when any source other than “AUX IN” is selected.

*12 Displayed only when an iPod is connected and playback is controlled from the unit.

*13 Displayed only when “USB-IPOD” is selected as the source and “IPOD MODE” is available for the connected iPod/iPhone (🔍 28).



Selecting the variable buttons and display color illumination

You can select your preferred color for buttons illumination (except for **EQ/BASS-TRE / DISP**) and display color separately.

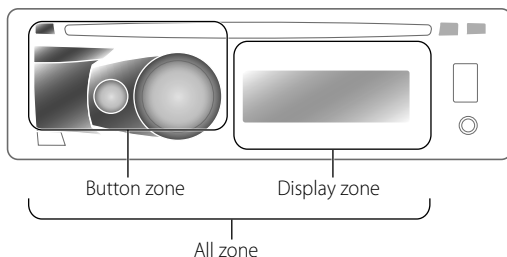

1 [Hold] or

2

⇒ <COLOR> ⇒ <BUTTON ZONE> / <DISP ZONE> / <ALL ZONE>

- Pressing **COLOR** in step **1** will enter zone selection menu (BUTTON ZONE / DISP ZONE / ALL ZONE) directly.

3

⇒ Select your preferred color from one of the 29 preset colors or <USER> color.

4 Repeat steps **2** and **3** to select a different zone and your preferred color.

- If <ALL ZONE> is selected in step **2**, the buttons and display illumination changed to the current/selected <BUTTON ZONE> color. You can also change the <ALL ZONE> color to one of your preferred color by performing step **3**.

5 or

⇒ Exit from the setting.

Creating your own day and night colors—USER

You can create your own colors for <DAY COLOR> and <NIGHT COLOR> to apply to button zone and display zone.

- <DAY COLOR> Displayed when <DIMMER> is set to <DIMMER OFF>.
- <NIGHT COLOR> Displayed when <DIMMER> is set to <DIMMER ON>.

Menu hierarchy		Operation	
COLOR SETUP	DAY COLOR	• BUTTON ZONE	Follow example below.
		• DISP ZONE	Press BACK after step 5, then select DISP ZONE in step 2.
	NIGHT COLOR	• BUTTON ZONE	Press BACK after step 5, then select NIGHT COLOR in step 2.
		• DISP ZONE	

Ex.: Creating <USER> color for <BUTTON ZONE> in <DAY COLOR>.

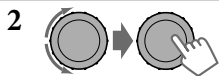
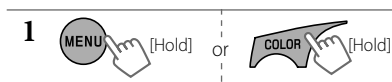

⇒ <COLOR SETUP> ⇒ <DAY COLOR>
⇒ <BUTTON ZONE>

- Pressing **COLOR** in step 1 will enter zone selection menu (BUTTON ZONE / DISP ZONE) directly.

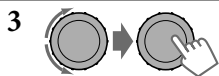

⇒ Select a primary color.

RED ↔ **GREEN** ↔ **BLUE** ↔ (back to the beginning)

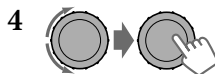

⇒ Adjust the level of the selected primary color.

00 to 31

5 Repeat steps 3 and 4 to adjust other primary colors.

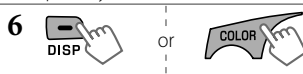

⇒ Exit from the setting.

If "00" is selected for all the primary colors (as in step 4) for <DISP ZONE>, nothing appear on the display.

More about this unit

Basic operations

General

- If you turn off the power while listening to a track, playback will start from where it had been stopped previously next time you turn on the power.
- If no operation is done for about 60 seconds after pressing **MENU** button, the operation will be canceled.

Tuner operations

Storing stations in memory

- During SSM search...
 - All previously stored stations are erased and the stations are stored anew.
 - When SSM is over, the station stored in the lowest preset number will be automatically tuned in.
- When storing a station manually, the previously preset station is erased when a new station is stored in the same preset number.

Disc/USB operations

Caution for DualDisc playback

- The Non-DVD side of a "DualDisc" does not comply with the "Compact Disc Digital Audio" standard. Therefore, the use of Non-DVD side of a DualDisc on this product may not be recommended.

General

- This unit has been designed to reproduce CDs/CD Texts, and CD-Rs (Recordable)/CD-RWs (Rewritable) in audio CD (CD-DA), MP3 and WMA formats.
- If you change the source while listening to a disc, playback stops. Next time you select "CD" as the playback source, playback will start from where it had been stopped previously.

- When a disc is inserted upside down, "PLEASE" and "EJECT" appear alternately on the display. Press **▲** to eject the disc.
- If the ejected disc is not removed within 15 seconds, it is automatically inserted into the loading slot again to protect it from dust. Playback starts automatically.
- MP3 and WMA "tracks" (words "file" and "track" are used interchangeably) are recorded in "folders."
- While fast-forwarding or reversing on an MP3 or WMA disc, you can only hear intermittent sounds.

Playing a CD-R or CD-RW

- Use only "finalized" CD-Rs or CD-RWs.
- This unit can only play back files of the same type as those detected first if a disc includes both audio CD (CD-DA) files and MP3/WMA files.
- This unit can play back multi-session discs; however, unclosed sessions will be skipped while playing.
- Some CD-Rs or CD-RWs may not play back on this unit because of their disc characteristics, or for the following reasons:
 - Discs are dirty or scratched.
 - Moisture condensation has occurred on the lens inside the unit.
 - The pickup lens inside the unit is dirty.
 - The files on the CD-R/CD-RW are written using the "Packet Write" method.
 - There are improper recording conditions (missing data, etc.) or media conditions (stained, scratched, warped, etc.).
- CD-RWs may require a longer readout time since the reflectance of CD-RWs is lower than that of regular CDs.
- Do not use the following CD-Rs or CD-RWs:
 - Discs with stickers, labels, or a protective seal stuck to the surface.

–Discs on which labels can be directly printed by an ink jet printer.

Using these discs under high temperature or high humidity may cause malfunctions or damage to the unit.

Playing an MP3/WMA disc

- This unit can play back MP3/WMA files with the extension code <.mp3> or <.wma> (regardless of the letter case—upper/lower).
- This unit can show the names of albums, artists (performer), and Tag (Version 1.0, 1.1, 2.2, 2.3, or 2.4) for MP3 files and for WMA files.
- This unit can display only one-byte characters. No other characters can be correctly displayed.
- This unit can play back MP3/WMA files meeting the conditions below:
 - Bit rate of MP3/WMA: 32 kbps — 320 kbps
 - Sampling frequency of MP3:
 - 32 kHz, 44.1 kHz, 48 kHz (for MPEG-1)
 - 16 kHz, 22.05 kHz, 24 kHz (for MPEG-2)
 - Sampling frequency of WMA:
 - 22.05 kHz, 32 kHz, 44.1 kHz, 48 kHz
 - Disc format: ISO 9660 Level 1/Level 2, Romeo, Joliet, Windows extension
- The maximum number of characters for file/folder names (includes 4 extension characters—<.mp3> or <.wma>).
 - ISO 9660 Level 1: up to 12 characters
 - ISO 9660 Level 2: up to 31 characters
 - Romeo: up to 64 characters
 - Joliet: up to 32 characters
 - Windows extension: up to 64 characters
- This unit can recognize a total of 512 files, 255 folders, and 8 hierarchical levels.
- This unit can play back files recorded in VBR (variable bit rate).
Files recorded in VBR have a discrepancy in the elapsed time display, and do not show the actual elapsed time. In particular, this difference becomes noticeable after performing the search function.

- This unit cannot play back the following files:
 - MP3 files encoded in MP3i and MP3 PRO format.
 - MP3 files encoded in an inappropriate format.
 - MP3 files encoded with Layer 1/2.
 - WMA files encoded in lossless, professional, and voice format.
 - WMA files which are not based upon Windows Media® Audio.
 - WMA files copy-protected with DRM.
 - Files which have data such as AIFF, ATAC3, etc.
- The search function works but search speed is not constant.

Playing MP3/WMA tracks from a USB device

- While playing from a USB device, the playback order may differ from other players.
- This unit may be unable to play back some USB devices or some files due to their characteristics or recording conditions.
- Depending on the shape of the USB devices and connection ports, some USB devices may not be attached properly or the connection might be loose.
- Connect one USB mass storage class device to the unit at a time. Do not use a USB hub.
- If the connected USB device does not have the correct files, "CANNOT PLAY" appears.
- This unit can show Tag (Version 1.0, 1.1, 2.2, 2.3, or 2.4) for MP3 files and for WMA files.
- This unit can play back MP3/WMA files meeting the conditions below:
 - Bit rate of MP3/WMA: 32 kbps — 320 kbps
 - Sampling frequency of MP3:
 - 32 kHz, 44.1 kHz, 48 kHz (for MPEG-1)
 - 16 kHz, 22.05 kHz, 24 kHz (for MPEG-2)
 - Sampling frequency of WMA:
 - 22.05 kHz, 32 kHz, 44.1 kHz, 48 kHz
- This unit can play back MP3 files recorded in VBR (variable bit rate).



- The maximum number of characters for:
 - Folder names : 32 characters
 - File names : 32 characters
 - MP3 Tag : 64 characters
 - WMA Tag : 32 characters
- This unit can recognize a total of 5 000 files, 255 folders (255 files per folder including folder without unsupported files), and of 8 hierarchies.
- This unit does not support SD card reader.
- This unit cannot recognize a USB device whose rating is other than 5 V and exceeds 500 mA.
- USB devices equipped with special functions such as data security functions cannot be used with the unit.
- Do not use a USB device with 2 or more partitions.
- This unit may not recognize a USB device connected through a USB card reader.
- This unit may not play back files in a USB device properly when using a USB extension cord.
- This unit cannot play back the following files:
 - MP3 files encoded in MP3i and MP3 PRO format.
 - MP3 files encoded in an inappropriate format.
 - MP3 files encoded with Layer 1/2.
 - WMA files encoded in lossless, professional, and voice format.
 - WMA files which are not based upon Windows Media® Audio.

Bluetooth operations

- While driving, do not perform complicated operation such as dialing the numbers, using phone book, etc. When you perform these operations, stop your car in a safe place.
- Some Bluetooth devices may not be connected to this unit depending on the Bluetooth version of the device.

- This unit may not work for some Bluetooth devices.
- Connecting condition may vary depending on the circumstances around you.
- When the unit is turned off, the device is disconnected.

iPod/iPhone operations

- You can control the following types of iPods/iPhone:
 - iPod with video (5th Generation) *1
 - iPod classic *1, *2
 - iPod nano
 - iPod nano (2nd Generation)
 - iPod nano (3rd Generation) *1, *2
 - iPod nano (4th Generation) *1, *2
 - iPod nano (5th Generation) *1, *2
 - iPod touch *1, *2
 - iPod touch (2nd Generation) *1, *2
 - iPhone/iPhone 3G/iPhone 3GS *1, *2
- *1 *It is not possible to browse video files on the "Videos" menu.*
- *2 <IPOD MODE> is available  16).
- If the iPod does not play correctly, please update your iPod software to the latest version. For details about updating your iPod, visit <<http://www.apple.com>>.
- When you turn on this unit, the iPod is charged through this unit.
- iPod shuffle cannot be used with this unit.
- The song order displayed on the selection menu of this unit may differ from that of the iPod.
- The text information may not be displayed correctly:
 - Some characters such as accented letters cannot be shown correctly on the display.
 - Communication between the iPod and the unit is not stable.
- If the text information includes more than 11 characters, it scrolls on the display. This unit can display up to 64 characters.

Maintenance

How to clean the connectors

Frequent detachment will deteriorate the connectors.

To minimize this possibility, periodically wipe the connectors with a cotton swab or cloth moistened with alcohol, being careful not to damage the connectors.

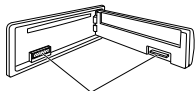

Connectors

Moisture condensation

Moisture may condense on the lens inside the unit in the following cases:

- After starting the heater in the car.
 - If it becomes very humid inside the car.
- Should this occur, the unit may malfunction. In this case, eject the disc and leave the unit turned on for a few hours until the moisture has evaporated.

How to handle discs

When removing a disc from its case, press down the center holder of the case and lift the disc out, holding it by the edges.

- Always hold the disc by the edges. Do not touch its recording surface.

When storing a disc in its case, gently insert the disc around the center holder (with the printed surface facing up).

- Make sure to store discs in cases after use.

Center holder

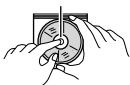

To keep discs clean

A dirty disc may not play correctly. If a disc does become dirty, wipe it with a soft cloth in a straight line from center to edge.



- Do not use any solvents (for example, conventional record cleaner, spray, thinner, benzene, etc.) to clean discs.

To play new discs

New discs may have some rough spots around the inner and outer edges. If such a disc is used, this unit may reject the disc.



To remove these rough spots, rub the edges with a pencil or ball-point pen, etc.

Do not use the following discs:

Single CD (8 cm disc) 	Warped disc
Sticker and sticker residue 	Stick-on label
Unusual shape 	C-thru Disc (semitransparent disc)
Transparent or semitransparent parts on its recording area 	

Troubleshooting

	Symptom	Remedy/Cause
General	Sound cannot be heard from the speakers.	<ul style="list-style-type: none"> • Adjust the volume to the optimum level. • Make sure the unit is not muted/paused (🔍 6). • Check the cords and connections.
	"PROTECT" appears on the display and no operations can be done.	<p>Check to be sure the terminals of the speaker leads are covered with insulating tape properly, then reset the unit (🔍 3).</p> <p>If "PROTECT" does not disappear, consult your JVC car audio dealer or a company supplying kits.</p>
	The unit does not work at all.	Reset the unit. (🔍 3)
	"AUX IN" cannot be selected.	Check the <SRC SELECT> → <AUX IN> setting. (🔍 23)
	Nothing appear on the display.	Check the <USER> color settings (🔍 25).
FM/AM	SSM automatic presetting does not work.	Store stations manually.
	Static noise while listening to the radio.	Connect the antenna firmly.
	"AM" cannot be selected.	Check the <SRC SELECT> → <AM> setting. (🔍 23)
Disc playback	Disc cannot be played back.	Insert the disc correctly.
	<ul style="list-style-type: none"> • CD-R/CD-RW cannot be played back. • Tracks on the CD-R/CD-RW cannot be skipped. 	<ul style="list-style-type: none"> • Insert a finalized CD-R/CD-RW. • Finalize the CD-R/CD-RW with the component which you used for recording.
	Disc can neither be played back nor ejected.	<ul style="list-style-type: none"> • Unlock the disc. (🔍 9) • Eject the disc forcibly. (🔍 3)
	Disc sound is sometimes interrupted.	<ul style="list-style-type: none"> • Stop playback while driving on rough roads. • Change the disc. • Check the cords and connections.
	"NO DISC" appears on the display.	Insert a playable disc into the loading slot.
	"PLEASE" and "EJECT" appear alternately on the display.	Press ▲, then insert a disc correctly.

	Symptom	Remedy/Cause
MP3/WMA playback	Disc cannot be played back.	<ul style="list-style-type: none"> • Use a disc with MP3/WMA tracks recorded in a format compliant with ISO 9660 Level 1, Level 2, Romeo, or Joliet. • Add the extension code <.mp3> or <.wma> to the file names.
	Noise is generated.	Skip to another track or change the disc. (Do not add the extension code <.mp3> or <.wma> to non-MP3 or WMA tracks.)
	A longer readout time is required ("READING" keeps flashing on the display).	Do not use too many hierarchical levels and folders.
	Tracks do not play back in the order you have intended them to play.	The playback order is determined when the files are recorded.
	The elapsed playing time is not correct.	This sometimes occurs during playback. This is caused by how the tracks are recorded on the disc.
	"NO FILE" appears on the display.	Selected folder is an empty folder *1. Select another folder that contains MP3/WMA tracks.
	"NOT SUPPORT" appears on the display and track skips.	Skip to the next track encoded in an appropriate format or to the next non-copy-protected WMA track.
USB device playback	The correct characters are not displayed (e.g. album name).	This unit can only display letters (upper case), numbers, and a limited number of symbols. (📁 8)
	Noise is generated.	The track played back is not an MP3/WMA track. Skip to another file. (Do not add the extension code <.mp3> or <.wma> to non-MP3 or WMA tracks.)
	"READING" keeps flashing on the display.	<ul style="list-style-type: none"> • Readout time varies depending on the USB device. • Do not use too many hierarchy or folders. • Turn off the power then on again. • Reattach the USB device again.
	"NO FILE" appears on the display.	Selected folder is an empty folder *1. Select another folder that contains MP3/WMA tracks.
	"NOT SUPPORT" appears on the display and track skips.	Skip to the next track encoded in an appropriate format or to the next non-copy-protected WMA track.
Tracks/folders are not played back in the order you have intended.	The playback order is determined by the write-in time stamp. The first track/folder written into the USB device will be the first track/folder for playback.	

*1 Folder that is physically empty or folder that contains data but does not contain valid MP3/WMA track.



	Symptom	Remedy/Cause
USB device playback	<ul style="list-style-type: none"> • "CANNOT PLAY" flashes on the display. • "NO USB" appears on the display. • The unit cannot detect the USB device. 	<ul style="list-style-type: none"> • Attach a USB device that contains tracks encoded in an appropriate format. • Reattach the USB device again.
	While playing a track, sound is sometimes interrupted.	The MP3/WMA tracks have not been properly copied into the USB device. Copy MP3/WMA tracks again into the USB device, and try again.
	Correct characters are not displayed (e.g. album name).	This unit can only display letters (upper case), numbers, and a limited number of symbols. (📷 8)
Bluetooth *2	Bluetooth device does not detect the unit.	The unit can be connected with one Bluetooth mobile phone and one Bluetooth audio device at a time. While connecting a device, this unit cannot be detected from another device. Disconnect currently connected device and search again.
	The unit does not detect the Bluetooth device.	<ul style="list-style-type: none"> • Check the Bluetooth setting of the device. • Search from the Bluetooth device. After the device detects the unit, select "OPEN" on the unit to connect the device. (📷 11)
	The unit does not make pairing with the Bluetooth device.	<ul style="list-style-type: none"> • Enter the same PIN code for both the unit and target device. • Select the device name from "SPECIAL," then try to connect again. (📷 12) • Try to pair/connect from the Bluetooth device.
	Echo or noise occurs.	Adjust the microphone unit position.
	Phone sound quality is poor.	<ul style="list-style-type: none"> • Reduce the distance between the unit and the Bluetooth mobile phone. • Move the car to a place where you can get a better signal reception.
	The sound is interrupted or skipped during playback of a Bluetooth audio device.	<ul style="list-style-type: none"> • Reduce the distance between the unit and the Bluetooth audio device. • Disconnect the device connected for "BT-PHONE." • Turn off, then turn on the unit. • (When the sound is not yet restored,) connect the device again.
	The connected audio device cannot be controlled.	Check whether the connected audio device supports AVRCP (Audio/Video Remote Control Profile).

*2 For Bluetooth operations, refer also to the instructions supplied with the Bluetooth Adapter.

	Symptom	Remedy/Cause
iPod/iPhone	The iPod does not turn on or does not work.	<ul style="list-style-type: none"> • Check the connecting cable and its connection. • Update the firmware version of the iPod/iPhone. • Charge the battery of the iPod/iPhone. • Reset the iPod/iPhone. • Check whether <IPOD SWITCH> setting is appropriate (🔍 23).
	The sound is distorted.	Deactivate the equalizer either on this unit or the iPod/iPhone.
	A lot of noise is generated.	Turn off (uncheck) the “VoiceOver” feature of the iPod. For details, visit < http://www.apple.com >.
	Playback stops.	The headphones are disconnected during playback. Restart the playback operation (🔍 16).
	“CANNOT PLAY” appears on the display.	No tracks are stored. Import tracks to the iPod/iPhone.
	“RESTRICTED” appears on the display.	Check whether the connected iPod/iPhone is compatible with this unit (🔍 28).

JVC bears no responsibility for any loss of data in an iPod/iPhone and/or USB mass storage class device while using this System.

- Microsoft and Windows Media are either registered trademarks or trademarks of Microsoft Corporation in the United States and/or other countries.
- The Bluetooth word mark and logos are owned by the Bluetooth SIG, Inc. and any use of such marks by Victor Company of Japan, Limited (JVC) is under license. Other trademarks and trade names are those of their respective owners.
- “Made for iPod” means that an electronic accessory has been designed to connect specifically to iPod and has been certified by the developer to meet Apple performance standards.
- “Works with iPhone” means that an electronic accessory has been designed to connect specifically to iPhone and has been certified by the developer to meet Apple performance standards.
- Apple is not responsible for the operation of this device or its compliance with safety and regulatory standards.
- iPod is a trademark of Apple Inc., registered in the U.S. and other countries.
- iPhone is a trademark of Apple Inc.

Specifications

AUDIO AMPLIFIER SECTION	Maximum Power Output:	Front/ Rear:	50 W per channel	
	Continuous Power Output (RMS):	Front/ Rear:	20 W per channel into 4 Ω , 40 Hz to 20 000 Hz at no more than 1% total harmonic distortion.	
	Load Impedance:		4 Ω (4 Ω to 8 Ω allowance)	
	Tone Control Range:	Bass:	± 12 dB (60 Hz, 80 Hz, 100 Hz, 200 Hz) Q1.0, Q1.25, Q1.5, Q2.0	
		Middle:	± 12 dB (0.5 kHz, 1.0 kHz, 1.5 kHz, 2.5 kHz) Q0.75, Q1.0, Q1.25	
		Treble:	± 12 dB (10.0 kHz, 12.5 kHz, 15.0 kHz, 17.5 kHz) Q (Fixed)	
	Frequency Response:		40 Hz to 20 000 Hz	
	Signal-to-Noise Ratio:		70 dB	
	Line-Out Level/Impedance:		5.0 V/20 k Ω load (full scale)	
	Subwoofer-Out Level/Impedance:		5.0 V/20 k Ω load (full scale)	
Output Impedance:		1 k Ω		
Other Terminal:	AUX (auxiliary) input jack, USB input jack, Antenna input, Expansion port, Steering wheel remote input			
TUNER SECTION	Frequency Range:	FM:	87.5 MHz to 108.0 MHz	
		AM:	531 kHz to 1 602 kHz	
	FM Tuner:	Usable Sensitivity:	9.3 dBf (0.8 μ V/75 Ω)	
		50 dB Quietening Sensitivity:	16.3 dBf (1.8 μ V/75 Ω)	
		Alternate Channel Selectivity (400 kHz):	65 dB	
		Frequency Response:	40 Hz to 15 000 Hz	
		Stereo Separation:	40 dB	
	AM Tuner:	Sensitivity:	20 μ V	
Selectivity:		40 dB		

CD PLAYER SECTION	Type:		Compact disc player	
	Signal Detection System:		Non-contact optical pickup (semiconductor laser)	
	Number of Channels:		2 channels (stereo)	
	Frequency Response:		5 Hz to 20 000 Hz	
	Dynamic Range:		96 dB	
	Signal-to-Noise Ratio:		98 dB	
	Wow and Flutter:		Less than measurable limit	
	MP3 Decoding Format: (MPEG1/2 Audio Layer 3)		Max. Bit Rate: 320 kbps	
	WMA (Windows Media® Audio) Decoding Format:		Max. Bit Rate: 320 kbps	
USB SECTION	USB Standard:		USB 1.1, USB 2.0	
	Data Transfer Rate (Full Speed):		Max. 12 Mbps	
	Compatible Device:		Mass storage class	
	Compatible File System:		FAT 32/16/12	
	Playable Audio Format:		MP3/WMA	
	Max. Current:		DC 5 V $\overline{\text{---}}$ 500 mA	
GENERAL	Power Requirement:	Operating Voltage:	DC 14.4 V (11 V to 16 V allowance)	
	Grounding System:		Negative ground	
	Allowable Operating Temperature:		0°C to +40°C	
	Dimensions (W × H × D): (approx.)	Installation Size:	182 mm × 52 mm × 160 mm	
		Panel Size:	188 mm × 58 mm × 6 mm	
Mass:		1.3 kg (excluding accessories)		

Design and specifications are subject to change without notice.



■ The countries where you may use the Bluetooth® function

- Die Länder, in denen Sie die Bluetooth® Funktion verwenden können
 - Pays où vous pouvez utiliser la fonction Bluetooth®
 - De landen waar u de Bluetooth®-functie mag gebruiken
 - Países en los que se puede utilizar la función Bluetooth®
 - Paesi nei quali è possibile utilizzare la funzione Bluetooth®
 - Länder där du kan använda Bluetooth®-funktionen
 - Lande, hvor du kan bruge Bluetooth®-funktionerne
 - Land hvor du kan bruke Bluetooth®-funksjonen
 - Maat, joissa voi käyttää Bluetooth®-toimintoa
 - Países onde pode usar a função Bluetooth®
 - Οι χώρες όπου μπορείτε να χρησιμοποιήσετε τη λειτουργία Bluetooth®
 - Страны, где можно воспользоваться функцией Bluetooth®
 - Země, ve kterých můžete využívat funkci Bluetooth®
 - Azok az országok, amelyekben használhatjuk a Bluetooth®-funkciót
 - Kraje, w których można używać funkcji Bluetooth®
 - Države, kjer lahko uporabljate funkcijo Bluetooth®
 - Krajiny, v ktorých môžete využívať funkciu Bluetooth®
 - Valstis, kur jūs varat izmantot Bluetooth® funkciju
 - Šalys, kuriose galite naudotis „Bluetooth®“ funkcija
 - Il-pajjiżi fejn tista' tuża l-funzjoni Bluetooth®
 - Lönd þar sem hægt er að nota Bluetooth®
 - Riigid, kus on võimalik kasutada Bluetooth® funktsiooni
 - Bluetooth® fonksiyonunu kullanabileceğiniz ülkeler
 - Na tíortha inar féidir leat feidhmiú Bluetooth® a úsáid
 - Länner an denen der d'Bluetooth® Funktioun benotze könnt.
 - Ở những quốc gia mà bạn có thể sử dụng chức năng Bluetooth®
 - Els països on podrà fer servir la funció Bluetooth®
 - Zemlje u kojima je dozvoljena upotreba Bluetooth® funkcije.
 - Zemlje u kojima možete koristiti Bluetooth® funkciju
 - Zemlje u kojima je dopušteno koristiti Bluetooth®.
 - Земљи каде можете да ја користите функцијата Bluetooth®
 - Страните, в които можете да ползвате функцията Bluetooth®
 - Tärile in care puteți utiliza funcția Bluetooth®
 - Die lande waar u die Bluetooth®-funksie kan gebruik
 - Amazwe lapho ungasebenzisa khona uhlelo lwe-Bluetooth®
 - Negara-negara yang membolehkan penggunaan fungsi Bluetooth®
 - Negara-negara yang anda boleh menggunakan fungsi Bluetooth®
 - 您能够使用 Bluetooth® 功能的国家
 - 您能夠使用 Bluetooth® 功能的國家
- המדינות שבהן באפשרותך להשתמש ב־Bluetooth®
- الدول التي يمكنك استخدام وظيفة Bluetooth® فيها

Country
Andorra
الإمارات العربية المتحدة
Australia
Österreich
Bosna i Hercegovina
Belgien Belgique
България
Canada
Schweiz Suisse
Κύπρος Kıbrıs
Česká republika
Deutschland
Danmark
Eesti
España
Suomi Finland
France
United Kingdom
Ελλάδα
Hong Kong 香港 香港
Hrvatska
Magyarország
Indonesia
Ireland Éire
ישראל إسرائيل
Ísland
Italia
Lichtenstein
Lietuva

Country
Luxemburg Luxembourg Lëtzebuerg
Latvija
Monaco
Crna Gora
Македонија
Malta
Nederland
Norge
New Zealand
Polska
Portugal
România
Srbija
Россия
Sverige
Singapore 新加坡 Singapura
Slovenija
Slovensko
Türkiye 台灣
United States of America
Vietnam Việt Nam
South Africa ENingizimu Afrika Suid-Afrika

Having TROUBLE with operation?

Please reset your unit

Refer to page of How to reset your unit

หากมีปัญหากับการใช้งาน

กรุณา กดปุ่มตั้งค่าเริ่มต้นใหม่

กรุณา ดูหน้าวิธีตั้งค่าเครื่องใหม่

JVC



EN, TH

© 2009 Victor Company of Japan, Limited

1209DTSMDTJEIN

JVC KD-R616

Installation/Connection Manual

การติดตั้ง/คู่มือการติดตั้ง

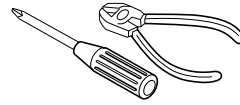

GET0639-006A
[U/UH]

1209DTSMDTJEIN
EN, TH

© 2009 Victor Company of Japan, Limited

ENGLISH / ไทย

You need the installation kits which corresponds to your car. /
ต้องใช้ชุดติดตั้งที่เหมาะสมกับรถของท่าน

Check the battery system in your car /
ตรวจสอบระบบแบตเตอรี่ในรถ



WARNINGS / คำเตือน

- To prevent short circuits:
 - Disconnect the battery's negative terminal and make all electrical connections before installing the unit.
 - Cover the terminals of the UNUSED leads with insulating tape.
- Be sure to ground this unit to the car's chassis again after installation.
- Replace the fuse with one of the specified rating.
- Connect speakers with a maximum power of more than 50 W (impedance of 4 Ω to 8 Ω). Otherwise, change the <AMP GAIN> setting. (See page 23 of the INSTRUCTIONS.)
- The heat sink becomes very hot after use. Be careful not to touch it when removing this unit.

- เพื่อป้องกันไฟฟ้าลัดวงจร:
 - ถอดขั้วลบของแบตเตอรี่ออก และเชื่อมต่อไฟฟ้าทั้งหมดก่อนติดตั้งเครื่อง
 - ปิดขั้วต่อของสายที่ไม่ได้ใช้ด้วยเทปป้องกัน
- ตรวจสอบให้แน่ใจว่าติดตั้งเครื่องกับโครงรถก่อนการติดตั้ง
- เปลี่ยนฟิวส์เป็นฟิวส์ตามพิกัดที่ระบุ
- ต่อลำโพงเข้ากับแหล่งจ่ายไฟที่ไม่เกิน 50 W (ค่าความต้านทาน 4 Ω ถึง 8 Ω) หรือเปลี่ยนการตั้งค่า <AMP GAIN> (ดูหน้า 23 คำแนะนำ)
- แผ่นระบายความร้อนร้อนมากหลังใช้งาน ห้ามสัมผัสเมื่อถอดเครื่องออก

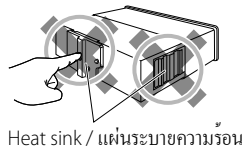

PRECAUTIONS on power supply and speaker connections

- DO NOT connect the speaker leads of the power cord to the car battery; otherwise, the unit will be seriously damaged.
- BEFORE connecting the speaker leads of the power cord to the speakers, check the speaker wiring in your car.

ข้อควรระวังเกี่ยวกับการเชื่อมต่อแหล่งจ่ายไฟและลำโพง

- อย่าต่อสายลำโพงที่เป็นสายไฟกับแบตเตอรี่รถยนต์ ไม่เช่นนั้นเครื่องอาจได้รับความเสียหายร้ายแรง
- ก่อนต่อสายลำโพงที่เป็นสายไฟกับลำโพง ควรตรวจสอบการเดินสายลำโพงในรถของท่าน

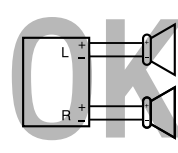
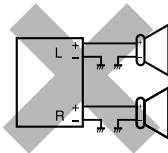
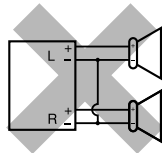

INSTALLATION / การติดตั้ง

The following illustration shows a typical installation. If you have any questions or require information regarding installation kits, consult your JVC car audio dealer or a company supplying kits.

ภาพประกอบต่อไปนี้แสดงการติดตั้งแบบปกติ หากท่านมีคำถามหรือต้องการข้อมูลเกี่ยวกับชุดติดตั้ง โปรดปรึกษาตัวแทนจำหน่ายเครื่องเสียงติดรถยนต์ JVC ของท่านหรือบริษัทที่จัดหาชุดอุปกรณ์ให้

In-dash mounting / การติดตั้งจอแบบ In-dash

1

2

3

Do the required electrical connections.
เชื่อมต่อไฟฟ้าที่จำเป็น

Install the unit at an angle of less than 30°.
ติดตั้งเครื่องในมุมน้อยกว่า 30°

Bend the appropriate tabs to hold the sleeve firmly in place.
บิดแถบล็อคเพื่อรองรับปลอกหุ้มให้เข้าที่อย่างแน่นหนา

Part list / รายการอุปกรณ์

- (A) Hard case / โครงแบบหนา (x1)
- (B) Control panel / แผงควบคุม (x1)
- (C) Sleeve / ปลอกหุ้ม (x1)
- (D) Trim plate / ทรिमเพลท (x1)
- (E) Power cord / สายไฟ (x1)
- (F) Handles / ที่จับ (x2)

When installing the unit without using the sleeve / เมื่อติดตั้งเครื่องโดยไม่ใช้ปลอกหุ้ม

Flat head screws (M5 × 8 mm) / ตะปูควงหัวแบน (M5 × 8 mm) *2

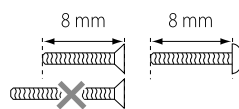
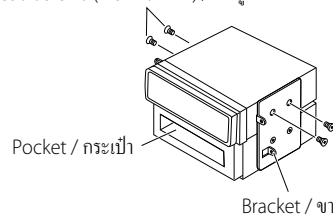

Removing the unit / การถอดเครื่อง

Release the rear section first... / ปลอยส่วนหลังก่อน...

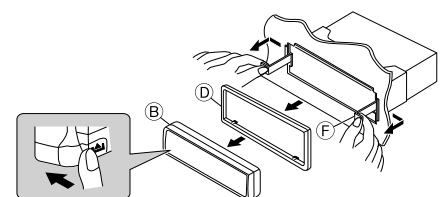

*1 When you stand the unit, be careful not to damage the fuse on the rear.
*2 Not supplied for this unit.

*1 เมื่อวางเครื่อง ระวังอย่าทำให้ฟิวส์ด้านหลังเสียหาย
*2 ไม่ได้จัดสิ่งนี้สำหรับเครื่องนี้

ELECTRICAL CONNECTIONS / การเชื่อมต่อไฟฟ้า

IMPORTANT: A custom wiring harness (separately purchased) which is suitable for your car is recommended for connection between the unit and your car.
 • Consult your JVC car audio dealer or a company supplying kits for details.

ข้อสำคัญ: ขอแนะนำให้ใช้ชุดสายไฟแบบสำเร็จ (แยกซื้อต่างหาก) ซึ่งเหมาะสมสำหรับรถของคุณ เพื่อใช้เชื่อมต่อระหว่างเครื่องและรถ
 • สอบถามตัวแทนจำหน่ายวิทยุ JVC ของคุณหรือบริษัทที่จัดส่งชุดอุปกรณ์เพื่อขอรายละเอียด

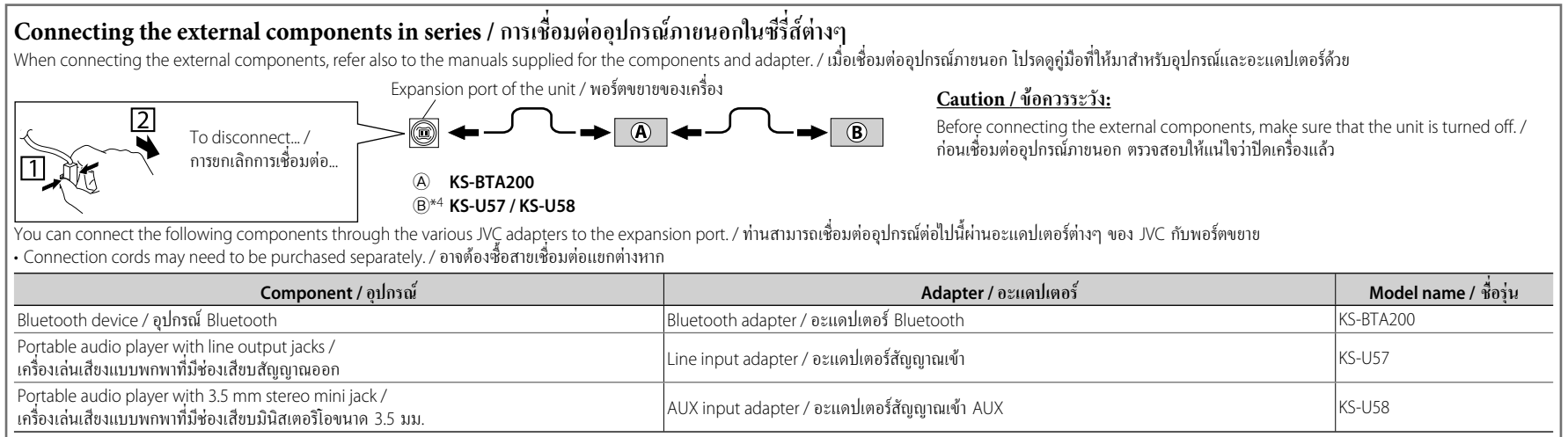
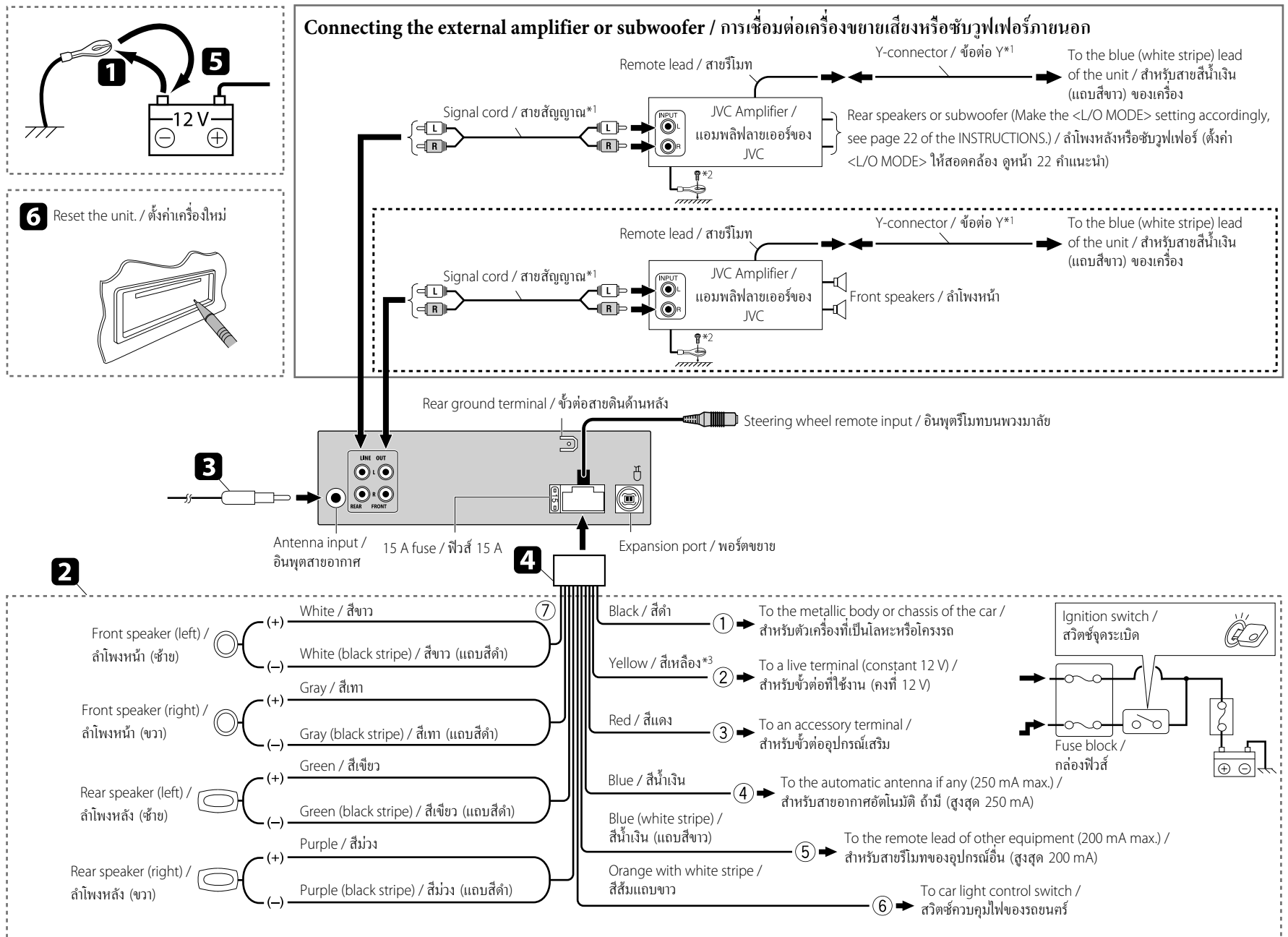

- *1 Not supplied for this unit.
- *2 Firmly attach the ground wire to the metallic body or to the chassis of the car—to the place uncoated with paint.
- *3 Before checking the operation of this unit prior to installation, this lead must be connected; otherwise, the power cannot be turned on.
- *4 To use these components, set the external input setting correctly (see page 23 of the INSTRUCTIONS).
- *1 ไม่ได้จัดส่งให้สำหรับเครื่องนี้
- *2 ติดสายดินกับตัวเครื่องที่เป็นโลหะหรือโครงรถให้แน่นหนา—ในส่วนที่ไม่ได้พ่นสีทับ
- *3 ก่อนตรวจสอบการทำงานของเครื่องนี้ก่อนการติดตั้ง สายไฟต้องต่อไว้แล้ว ไม่เช่นนั้นจะไม่สามารถเปิดเครื่องได้
- *4 หากต้องการใช้อุปกรณ์เหล่านี้ ให้การตั้งค่าสัญญาณเข้าภายนอกให้ถูกต้อง (ดูหน้า 23 ของคำแนะนำ)

TROUBLESHOOTING / การแก้ไขปัญหาเบื้องต้น

- **The fuse blows.** ⇒ Are the red and black leads connected correctly?
- **Power cannot be turned on.** ⇒ Is the yellow lead connected?
- **No sound from the speakers.** ⇒ Is the speaker output lead short-circuited?
- **"PROTECT" appears on the display and no operation can be done.** ⇒ Is the speaker output lead short-circuited or touches the chassis of the car/head unit?; Have you reset your unit?
- **Sound is distorted.** ⇒ Is the speaker output lead grounded?; Are the "-" terminals of L and R speakers grounded in common?
- **Noise interfere with sounds.** ⇒ Is the rear ground terminal connected to the car's chassis using shorter and thicker cords?
- **This unit becomes hot.** ⇒ Is the speaker output lead grounded?; Are the "-" terminals of L and R speakers grounded in common?
- **This unit does not work at all.** ⇒ Have you reset your unit?
- **ฟิวส์ขาด** ⇒ ต่อสายสีแดงและสีดำถูกต้องหรือไม่?
- **ไม่สามารถเปิดเครื่องได้** ⇒ ต่อสายสีเหลืองแล้วหรือไม่?
- **ไม่ได้ยินเสียงจากลำโพง** ⇒ สายสัญญาณออกของลำโพงลัดวงจรหรือไม่?
- **ข้อความ "PROTECT" ปรากฏขึ้นบนหน้าจอและเครื่องไม่สามารถทำงานได้** ⇒ สายสัญญาณออกของลำโพงลัดวงจรหรือสัมผัสกับโครงรถ/ตัวเครื่องหลักหรือไม่?; ท่านตั้งเครื่องใหม่ไว้หรือไม่?
- **เสียงผิดเพี้ยน** ⇒ สายสัญญาณออกของลำโพงต่อกับสายดินหรือไม่?; ขั้วต่อ "-" ของลำโพง L (ซ้าย) และ R (ขวา) ต่อสายดินไว้ด้วยกันหรือไม่?
- **มีเสียงรบกวน** ⇒ ขั้วต่อสายดินด้านหลังที่ต่อกับโครงรถใช้สายที่สั้นและหนากว่าหรือไม่?
- **เครื่องร้อน** ⇒ สายสัญญาณออกของลำโพงต่อกับสายดินหรือไม่?; ขั้วต่อ "-" ของลำโพง L (ซ้าย) และ R (ขวา) ต่อสายดินไว้ด้วยกันหรือไม่?
- **เครื่องทำงานไม่ได้เลย** ⇒ ท่านตั้งเครื่องใหม่ไว้หรือไม่?

JVC

ENGLISH

FRANÇAIS

KD-R611

CD RECEIVER / RÉCEPTEUR CD

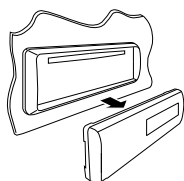

MP3 WMA Radio Data System

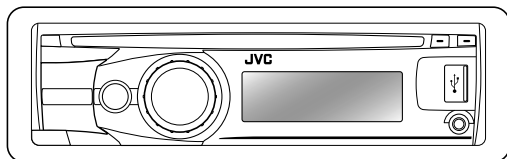

For canceling the display demonstration, see page 4. / Pour annuler la démonstration des affichages, référez-vous à la page 4.

For installation and connections, refer to the separate manual. / Pour l'installation et les raccordements, se référer au manuel séparé.

INSTRUCTIONS

MANUEL D'INSTRUCTIONS

GET0640-003A
[E/EU]

Thank you for purchasing a JVC product.

Please read all instructions carefully before operation, to ensure your complete understanding and to obtain the best possible performance from the unit.

IMPORTANT FOR LASER PRODUCTS

1. CLASS 1 LASER PRODUCT

2. CAUTION: Do not open the top cover. There are no user serviceable parts inside the unit; leave all servicing to qualified service personnel.

3. CAUTION: Visible and/or invisible class 1M laser radiation when open. Do not view directly with optical instruments.

4. REPRODUCTION OF LABEL: CAUTION LABEL, PLACED OUTSIDE THE UNIT.

CAUTION VISIBLE AND/OR INVISIBLE CLASS 1M LASER RADIATION WHEN OPEN. DO NOT VIEW DIRECTLY WITH OPTICAL INSTRUMENTS. REC00825-12001 (ENG)	ATTENTION RAYONNEMENT LASER VISIBLE ET/OU INVISIBLE DE CLASSE 1M LORS QU'EST NE PAS REGARDER DIRECTEMENT AVEC DES INSTRUMENTS OPTIQUES. (FRA)	AVISO RADIACION LASER DE CLASE 1M VISIBLE Y/O INVISIBLE CUANDO ESTA ABIERTO. NO MIRAR DIRECTAMENTE CON INSTRUMENTAL OPTICO. (ESP)	VARNING SYNLIG OCH/ELLER OSYNLIG LASERSTRÅLNING KLASS 1M, NÄR DENNA DEL ÄR ÖPPNAD. BETRÄKTA EJ STRÅLEN MED OPTISKA INSTRUMENT. (SWE)	注意 ここを開くと可視 及び/または不可視 のクラス1M レーザー放射が 出ます。 光学顕微鏡で直接 見ないでください。 (JPN)	CAUTION VISIBLE AND/OR INVISIBLE CLASS 1 LASER RADIATION WHEN OPEN. DO NOT STARE INTO BEAM. FDA 21 CFR (ENG)
---	---	---	--	---	---



Products

Battery

Information for Users on Disposal of Old Equipment and Batteries

[European Union only]

These symbols indicate that the product and the battery with this symbol should not be disposed as general household waste at its end-of-life.

If you wish to dispose of this product and the battery, please do so in accordance with applicable national legislation or other rules in your country and municipality.

By disposing of this product correctly, you will help to conserve natural resources and will help prevent potential negative effects on the environment and human health.

Notice:

The sign Pb below the symbol for batteries indicates that this battery contains lead.

Warning:

If you need to operate the unit while driving, be sure to look around carefully or you may be involved in a traffic accident.

For safety...

- Do not raise the volume level too much, as this will block outside sounds, making driving dangerous.
- Stop the car before performing any complicated operations.

Temperature inside the car...

If you have parked the car for a long time in hot or cold weather, wait until the temperature in the car becomes normal before operating the unit.

How to read this manual

The following icons/symbols are used to indicate:

 [Hold] Press and hold the button(s) until the desired operation begins.

 Turn the control dial.

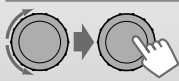
 Turn the control dial to make a selection, then press to confirm.

 XX Reference page number

<XXXX> Menu setting item

 Continued on the next page

How to attach/detach the control panel

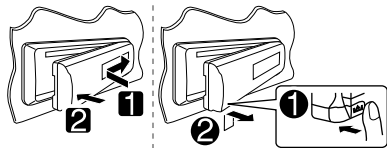

How to reset your unit

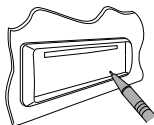

Your preset adjustments will also be erased (except the registered Bluetooth device). (🔍 13)

How to forcibly eject a disc

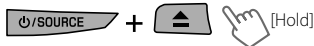

- You can forcibly eject the loaded disc even if the disc is locked. To lock/unlock the disc, (🔍 10).
- Be careful not to drop the disc when it ejects.
- If this does not work, reset your unit.

CONTENTS

- 3 How to read this manual
- 3 How to attach/detach the control panel
- 3 How to reset your unit
- 3 How to forcibly eject a disc
- 4 Canceling the display demonstration
- 4 Setting the clock
- 5 Preparing the remote controller (RM-RK50)
- 6 Basic operations
- 7 Listening to the radio
- 10 Listening to a disc
- 11 Listening to the USB device
- 12 Using Bluetooth® devices
 - 14 Using a Bluetooth mobile phone
 - 15 Using a Bluetooth audio player
- 17 Listening to the iPod/iPhone
- 19 Listening to the DAB tuner
- 21 Listening to the other external components
- 22 Selecting a preset sound mode
- 23 Menu operations
- 30 More about this unit
- 34 Maintenance
- 35 Troubleshooting
- 40 Specifications

Canceling the display demonstration

1 Turn on the power.



2 MENU [Hold]



4 Select <DEMO OFF>.



6 Finish the procedure.



Setting the clock

1 Turn on the power.



2 MENU [Hold]



3 Select <CLOCK>.



4 Select <CLOCK SET>.

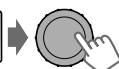

5 Adjust the hour.



6 Adjust the minute.



7 Select <24H/12H>.

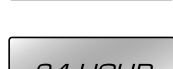
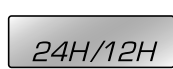

8 Select <24 HOUR> or <12 HOUR>.



9 Finish the procedure.



Preparing the remote controller (RM-RK50)

When you use the remote controller for the first time, pull out the insulation sheet.

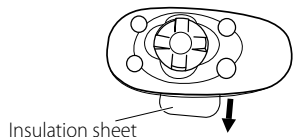

If the effectiveness of the remote controller decreases, replace the battery.

Replacing the lithium coin battery

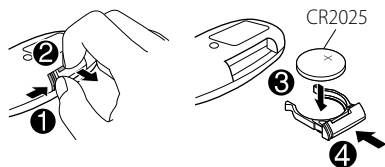

Caution:

- Danger of explosion if battery is incorrectly replaced. Replace only with the same or equivalent type.
- Battery shall not be exposed to excessive heat such as sunshine, fire, or the like.

Warning (to prevent accidents and damage):

- Do not install any battery other than CR2025 or its equivalent.
- Do not leave the remote controller in a place (such as dashboards) exposed to direct sunlight for a long time.
- Store the battery in a place where children cannot reach.
- Do not recharge, short, disassemble, heat the battery, or dispose of it in a fire.
- Do not leave the battery with other metallic materials.
- Do not poke the battery with tweezers or similar tools.
- Wrap the battery with tape and insulate when throwing away or saving it.

This unit is equipped with the steering wheel remote control function.







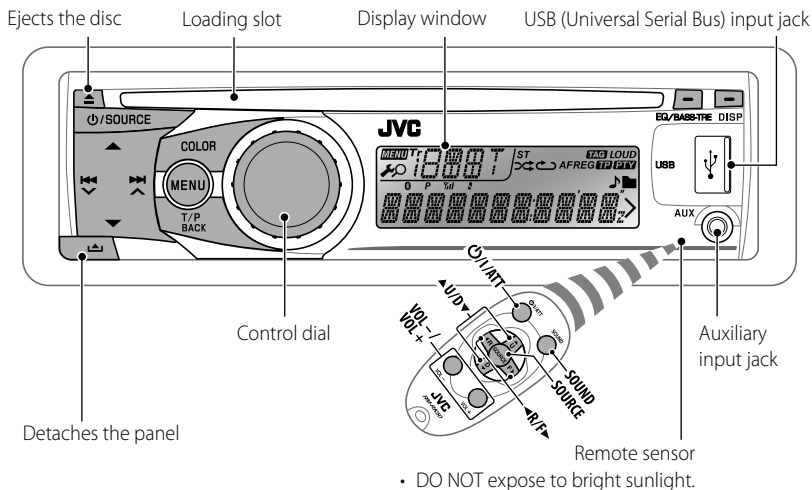



Before operating, connect a JVC's OE remote adapter (not supplied) which matches your car to the steering wheel remote input terminal on the rear of the unit.





- For details, refer also to the instructions supplied with the remote adapter.
-

Basic operations

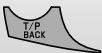

When you press or hold the following button(s)...

Main unit	Remote controller	General operation
		Turns on. • When the power is on, pressing  on the remote controller also mutes the sound or pauses. Press  again to cancel muting or resume playback. Turns off if pressed and held.
		Selects the available sources (if the power is turned on). • If the source is ready, playback also starts.
		Adjusts the volume level.
	—	Selects items.
	—	• Mutes the sound while listening to a source. If the source is “CD,” “USB” or “USB-IPOD,” playback pauses. Press the control dial again to cancel muting or resume playback. • Confirms selection.
		Selects the sound mode. • Enters tone level adjustment directly ( 22) if pressed and held EQ/BASS-TRE on the main unit.

Main unit	Remote controller	General operation
	—	<ul style="list-style-type: none"> • Enters <COLOR> setting directly ( 28). • Enters <COLOR SETUP> setting directly ( 29) if pressed and held.
	—	<ul style="list-style-type: none"> • Activates/deactivates TA Standby Reception. • Enters PTY Searching mode if pressed and held. • Returns to the previous menu.
	—	<p>Power off : Checks the current clock time.</p> <p>Power on : Changes the display information.</p>

Listening to the radio



1  

⇒ "FM" or "AM"

2  



"ST" lights up when receiving an FM stereo broadcast with sufficient signal strength.



Manual search

  "M" flashes, then press the button repeatedly.

[Hold]

When an FM stereo broadcast is hard to receive

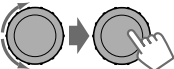
1   [Hold]

2  

⇒ <TUNER> ⇒ <MONO> ⇒ <MONO ON>

Reception improves, but stereo effect will be lost.



To restore the stereo effect, repeat the same procedure to select <MONO OFF>.



Automatic presetting (FM)—

SSM (Strong-station Sequential Memory)

You can preset up to 18 stations for FM.

While listening to a station...

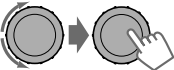
1   [Hold]

2  

⇒ <TUNER> ⇒ <SSM> ⇒ <SSM 01 - 06> / <SSM 07 - 12> / <SSM 13 - 18>

"SSM" flashes and local stations with the strongest signals are searched and stored automatically.

To preset another 6 stations, repeat the above procedure by selecting one of the other 6 SSM setting ranges.



Manual presetting (FM/AM)

You can preset up to 18 stations for FM and 6 stations for AM.

Ex: Storing FM station of 92.50 MHz into preset number "04."

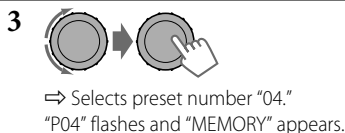
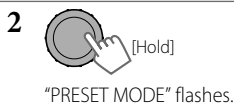

Selecting a preset station

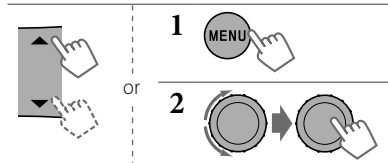

Changing the display information

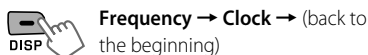

Using the remote controller

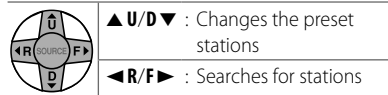

The following features are available only for FM Radio Data System stations.

Searching for your favourite FM Radio Data System programme—PTY Search

You can tune in to a station broadcasting your favourite programme by searching for a PTY code.



The last selected PTY code appears.

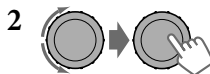

⇒ Select one of your favourite programme types or a PTY code, and start searching.

If there is a station broadcasting a programme of the same PTY code as you have selected, that station is tuned in.

PTY codes: NEWS, AFFAIRS, INFO, SPORT, EDUCATE, DRAMA, CULTURE, SCIENCE, VARIED, POP M (music), ROCK M (music), EASY M (music), LIGHT M (music), CLASSICS, OTHER M (music), WEATHER, FINANCE, CHILDREN, SOCIAL, RELIGION, PHONE IN, TRAVEL, LEISURE, JAZZ, COUNTRY, NATION M (music), OLDIES, FOLK M (music), DOCUMENT

Standby receptions

TA Standby Reception

TA Standby Reception allows the unit to switch temporarily to Traffic Announcement (TA) from any source other than AM.

- The volume changes to the preset TA volume level if the current level is lower than the preset level. (<TA VOLUME>,  24)

To activate TA Standby Reception



If the TP indicator lights up, TA Standby Reception is activated.

If the TP indicator flashes, TA Standby Reception is not yet activated.

- To activate the reception, tune in to another station providing Radio Data System signals required for TA Standby Reception.
- To deactivate the reception, press **T/P BACK** again.

PTY Standby Reception



PTY Standby Reception allows the unit to switch temporarily to your favourite PTY programme from any source other than AM.

To activate and select your favourite

PTY code for PTY Standby Reception, see <PTY-STANDBY> ( 24)

If the PTY indicator lights up, PTY Standby Reception is activated.

If the PTY indicator flashes, PTY Standby Reception is not yet activated.

- To activate the reception, tune in to another station providing these signals.
- To deactivate the reception, select <PTY OFF> ( 24) for the PTY code. The PTY indicator goes off.
- When a DAB tuner is connected, TA/PTY Standby Reception also searches for services ( 20).
- The unit will not switch to Traffic Announcement or PTY programme when a call connection is established through "BT-PHONE."

Tracing the same programme— Network-Tracking Reception

When driving in an area where FM reception is not sufficient enough, this unit automatically tunes in to another FM Radio Data System station of the same network, possibly broadcasting the same programme with stronger signals.

Programme A broadcasting on different frequency areas (01 – 05)

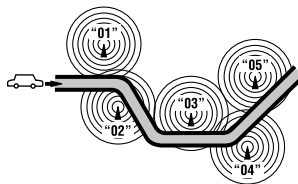

To change the Network-Tracking Reception setting, see <AF-REG> ( 24).

- When the DAB tuner is connected, refer to "Tracing the same programme—Alternative Frequency Reception (DAB AF)," ( 20).

Automatic station selection— Programme Search

Usually when you select a preset number, the station preset in that number is tuned in.

If the signals from the FM Radio Data System preset station are not sufficient for good reception, this unit, using the AF data, tunes in to another frequency possibly broadcasting the same programme as the original preset station is broadcasting. (<P-SEARCH>,  24)

Changing the display information



Station name (PS) → Station Frequency → Programme type (PTY) → Clock → (back to the beginning)

Listening to a disc



⇒ Turn on the power.

2

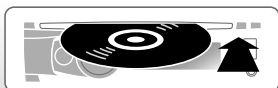

All tracks will be played repeatedly until you change the source or eject the disc.

Stopping playback and ejecting the disc



"NO DISC" appears.
Press **SOURCE** to listen to another playback source.

Prohibiting disc ejection



To cancel the prohibition, repeat the same procedure.

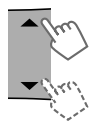

Selects folder of the MP3/WMA



Selects track



Fast-forwards or reverses the track

Selecting a track/folder



For MP3/WMA discs, select the desired folder, then the desired track by repeating the control dial procedures.

- If the MP3/WMA disc contains many tracks, you can fast search (± 10 , ± 100 , ± 1000) through the disc by turning the control dial quickly.
- To return to the previous menu, press **T/P BACK**.

Caution on volume setting:

Discs produce very little noise compared with other sources. Lower the volume before playing a disc to avoid damaging the speakers by the sudden increase of the output level.

Selecting the playback modes

You can use only one of the following playback modes at a time.

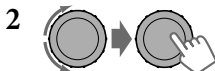

⇒ "REPEAT" ↔ "RANDOM"

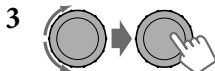

REPEAT

TRACK RPT : Repeats current track
FOLDER RPT : Repeats current folder

RANDOM

FOLDER RND : Randomly plays all tracks of current folder, then tracks of next folders
ALL RND : Randomly plays all tracks

To cancel repeat play or random play, select "RPT OFF" or "RND OFF."

Changing the display information



Disc title/Album name/performer (folder name)* → Track title (file name)* → Current track number with the elapsed playing time → Current track number with the clock time → (back to the beginning)

* If the current disc is an audio CD, "NO NAME" appears.

If an MP3/WMA file does not have Tag information or <TAG DISPLAY> is set to <TAG OFF> (🔍 24), folder name and file name appear.

Using the remote controller



▲ U/D ▼ : Selects folder of the MP3/WMA

◀ R/F ▶ : Selects track

◀ R/F ▶ : Fast-forwards or [Hold] reverses the track

Listening to the USB device

This unit can play MP3/WMA files stored on a USB mass storage class device.

You can connect a USB mass storage class device such as a USB memory, Digital Audio Player, etc. to the unit.

- You can also connect an Apple iPod/iPhone to the USB input jack. For details of the operations, 🔍 32.



⇒ Turn on the power.

2

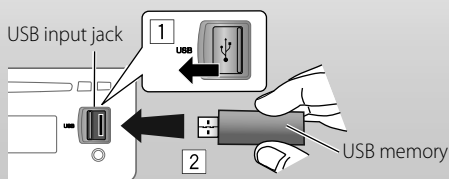

All tracks will be played repeatedly until you change the source or detach the USB device.

Caution on volume setting:

USB devices produce very little noise compared with other sources. Lower the volume before playing a USB to avoid damaging the speakers by sudden increase of the output level.

If you have turned off the power (without detaching the USB device)...

Pressing **⏻**/SOURCE turns on the power and playback starts from where it has been stopped previously.

- If a different USB device is currently attached, playback starts from the beginning.



Stop playing and detaching the USB device

Straightly pull it out from the unit. "NO USB" appears. Press **⏮/SOURCE** to listen to another playback source.

You can operate the USB device in the same way you operate the files on a disc.

 10, 11)

Cautions:

- Avoid using the USB device if it might hinder your safety driving.
- Do not pull out and attach the USB device repeatedly while "READING" is shown on the display.
- Do not start the car engine if a USB device is connected.

- This unit may not be able to play the files depending on the type of USB device.
- Operation and power supply may not work as intended for some USB devices.
- You cannot connect a computer to the USB input terminal of the unit.
- Make sure all important data has been backed up to avoid losing the data.
- Do not leave a USB device in the car, expose to direct sunlight, or high temperature to avoid deformation or cause damages to the device.
- Some USB devices may not work immediately after attaching USB device or turn on the power.
- For more details about USB operations,  32.

Using Bluetooth® devices

For Bluetooth operations, it is required to connect the Bluetooth adapter, KS-BTA200 (not supplied) to the expansion port on the rear of this unit.

- Refer to pages **i** and **ii** at the end of the manual to check the countries where you may use the Bluetooth® function.
- For details, refer also to the instructions supplied with the Bluetooth adapter and the Bluetooth device.

To use a Bluetooth device through the unit ("BT-PHONE" and "BT-AUDIO") for the first time, you need to establish a Bluetooth wireless connection between the unit and the device.

- Once the connection is established, it is registered on the unit even if you reset your unit. Up to five devices can be registered in total.
- Only one device can be connected at a time for each source ("BT-PHONE" and "BT-AUDIO").

Registration (Pairing) methods

Use either of the following items ("OPEN" or "SEARCH") in the Bluetooth menu to register and make the unit ready to establish a new Bluetooth connection with a device.

"OPEN" : Connection is established by operating the Bluetooth device.

"SEARCH" : Connection is established by operating the unit.

Registering using "OPEN"

Preparation: Operate the device to turn on its Bluetooth function.



⇒ "BT-PHONE" or "BT-AUDIO"



⇒ "NEW DEVICE" ⇒ "OPEN"



⇒ Enter a PIN (Personal Identification Number) code in to the unit.

You can enter any number you like (1-digit to 16-digit number).

[Initial: 0000]

- Some devices have their own PIN code. Enter the specified PIN code in to the unit.

4 Repeat step 3 until you have finished entering the PIN code.



"OPEN.." flashes.

6 Use the Bluetooth device to search and connect.

On the device to be connected, enter the same PIN code you have just entered for this unit. "CONNECTED" appears.

Now connection is established and you can use the device through the unit.

The device remains registered even after you disconnect the device. Use "CONNECT" (or activate "AUTO CNNECT") to connect the same device from next time on. (🔍 16)

Registering using "SEARCH"/"SPECIAL"



⇒ "BT-PHONE" or "BT-AUDIO"



⇒ "NEW DEVICE"



⇒ "SEARCH": To search for available devices

The unit searches and displays the list of the available devices. "UNFOUND" appears if no available device is detected.

----- or -----

⇒ "SPECIAL": To connect a special device

The unit displays the list of the preset devices.



⇒ Select a device you want to connect.

5 **For available devices...**

⇒ Enter the specific PIN code of the device to the unit.

- Refer to the instructions supplied with the device to check the PIN code. Use the Bluetooth device to connect. Now connection is established and you can use the device through the unit.

For special device...

Use "OPEN" or "SEARCH" to connect.



Connecting/disconnecting/ deleting a registered device

- 

⇒ "BT-PHONE" or "BT-AUDIO"
- 

⇒ Select a device you want to connect/disconnect/delete.
- 

⇒ "CONNECT" or "DISCONNECT": To connect/disconnect the selected device
----- or -----
⇒ "DELETE" ⇒ "YES": To delete the selected device

You can set the unit to connect the Bluetooth device automatically when the unit is turned on. ("AUTO CNNECT," )

Using a Bluetooth mobile phone

- 

⇒ "BT-PHONE"
- 

⇒ Bluetooth menu
- Make a call or setting using the Bluetooth setting menu.**
()





When a call comes in....

The source is automatically changed to "BT-PHONE."

- The display will flash in blue. (<RING COLOR>, )

When "AUTO ANSWER" is activated....

The unit answers the incoming calls automatically. ()

- When "AUTO ANSWER" is deactivated, press any button (except  /  / ) to answer the incoming call.
- You can adjust the microphone volume level. ()

To end the call

Hold any button (except  /  / )

When a text message comes in....

If the mobile phone is compatible with text message (notified through JVC Bluetooth adapter) and "MSG INFO" (message info) is set to "AUTOMATIC" () 16), the unit rings to inform you of the message arrival.



- "RCV MESSAGE" (receiving message) appears and the display illuminate in blue. (<RING COLOR>, )

Using the remote controller

	▲ U/D ▼ / : Answers calls
	◀ R / F ▶ / SOURCE
	▲ U/D ▼ / : Rejects calls
	◀ R / F ▶ / SOURCE [Hold]

Making a call

- 

⇒ "BT-PHONE"
- 
- 

⇒ Select "DIAL" menu.

4



⇒ Select a calling method.

PHONE BOOK* ↔ **MISSED*** ↔

NUMBER ↔ **VOICE DIAL** ↔

REDIAL* ↔ **RECEIVED*** ↔ (back to the beginning)

* *Displays only when your mobile phone is equipped with these functions and is compatible with this unit.*

5 **For REDIAL, RECEIVED, MISSED**

⇒ Repeat step 4 to select a name (if it is acquired) or a phone number.

For PHONE BOOK

⇒ Repeat step 4 to select a name or a phone number.

For NUMBER



⇒ Enter a phone number.



⇒ Confirm.

For VOICE DIAL

⇒ Speak the name you want to call when "SAY NAME" appears.

- If your mobile phone does not support the voice recognition system, "ERROR" appears.
- Using voice tags may be difficult in a noisy environment or during an emergency.

Using a Bluetooth audio player



⇒ "BT-AUDIO"

If playback does not start, operate the Bluetooth audio player to start playback.

Operate the Bluetooth audio player to pause (if playback does not pause when you change the source).



Reverse skips/forward skips



Pauses/starts playback*

* *Operation may be different according to the connected Bluetooth audio player.*



Enter setting menu (Device list)

For connecting/disconnecting/deleting a registered device, 14.

Using the remote controller



◀ **R/F** ▶ : Reverse skips/forward skips



Changing the Bluetooth settings



⇒ "BT-PHONE" or "BT-AUDIO"



⇒ Bluetooth menu



⇒ "SETTINGS"



⇒ Select a setting item.

AUTO CNNECT ↔ **AUTO ANSWER***1
↔ **MSG INFO***2 ↔ **MIC SETTING***1
↔ **VERSION***3 ↔ (back to the beginning)



⇒ Change the setting accordingly. For setting menu, right column.

*1 *Appears only when a Bluetooth phone is connected.*

*2 *Appears only when a Bluetooth phone is connected and it is compatible with text message (notified through JVC Bluetooth adapter).*

*3 *Bluetooth Audio: Shows only "Version."*

Bluetooth Information:

If you wish to receive more information about Bluetooth, visit the following JVC web site: <<http://www.jvc.co.jp/english/car/>> (English website only)

Setting menu [Initial: Underlined]

AUTO CNNECT (connect)

When the unit is turned on, the connection is established automatically with...

OFF: No Bluetooth device.

LAST: The last connected Bluetooth device.

ORDER: The available registered Bluetooth device found at first.

AUTO ANSWER

Only for the device being connected for "BT-PHONE."

ON: The unit answers the incoming calls automatically.

OFF: The unit does not answer the calls automatically. Answer the calls manually.

REJECT: The unit rejects all incoming calls.

MSG INFO (message info)

Only for the device being connected for "BT-PHONE."

AUTOMATIC: The unit informs you of the arrival of a message by ringing and displaying "RCV MESSAGE" (receiving message).

- The display illuminate in blue. (<RING COLOR>, 25)

MANUAL: The unit does not inform you of the arrival of a message.

MIC SETTING (microphone setting)

Only for the device being connected for "BT-PHONE." Adjust microphone volume connected to the Bluetooth adapter, [**LEVEL 01/02/03**].

VERSION

The Bluetooth software and hardware versions are shown.

Warning messages

ERROR CNCT (Error Connection)

The device is registered but the connection has failed. Use "CONNECT" to connect the device again. (🔌 14)

ERROR

Try the operation again. If "ERROR" appears again, check if the device supports the function you have tried.

UNFOUND

No available Bluetooth device is detected by "SEARCH."

LOADING*

The unit is updating the phone book.

PLEASE WAIT

The unit is preparing to use the Bluetooth function. If the message does not disappear, turn off and turn on the unit, then connect the device again (or reset the unit).

RESET 8

Check the connection between the adapter and this unit.

**Displays only when your mobile phone is equipped with these functions and is compatible with this unit.*

Listening to the iPod/iPhone

You can connect the iPod/iPhone using the USB 2.0 cable (accessory of the iPod/iPhone) to the USB input jack on the control panel.

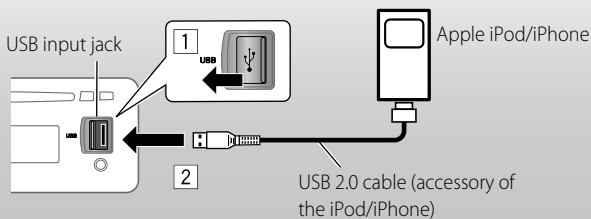

- Disconnecting the iPod/iPhone will stop playback. Press **🔊/SOURCE** to listen to another playback source.
- For details, refer also to the instructions supplied with your iPod/iPhone.

Caution:

- Avoid using the iPod/iPhone if it might hinder your safety while driving.
- Make sure all important data has been backed up to avoid losing the data.



There are two control terminals:

- <HEAD MODE> Control by this unit.
- <IPOD MODE> Control by the connected iPod/iPhone.

Preparation: Select the controlling terminal, <HEAD MODE> or <IPOD MODE> for iPod playback:

- Press and hold **T/P BACK** button.
- Make the selection from <IPOD SWITCH> setting,  27.

The operations explained below are under <HEAD MODE>.

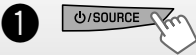

⇒ "USB-IPOD"

Playback starts automatically.



⇒ Select a song.



Pauses or resumes playback



Selects track



Fast-forwards or reverses the track

Selecting a track from the menu

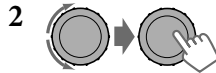

⇒ Select the desired menu.

PLAYLISTS ↔ **ARTISTS** ↔ **ALBUMS**

↔ **SONGS** ↔ **PODCASTS** ↔

GENRES ↔ **COMPOSERS** ↔

AUDIOBOOKS ↔ (back to the

beginning)

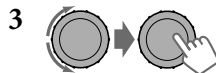

⇒ Select the desired track.

Repeat this procedure until the desired track is selected.

- If the selected menu contains many tracks, you can fast search (± 10 , ± 100 , ± 1000) through the menu by turning the control dial quickly.
- To return to the previous menu, press **T/P BACK**.

Selecting the playback modes

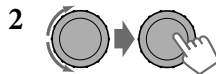

⇒ "REPEAT" ↔ "RANDOM"

3

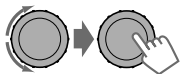
**REPEAT**

- ONE RPT** : Functions the same as "Repeat One" of the iPod
- ALL RPT** : Functions the same as "Repeat All" of the iPod

RANDOM

- ALBUM RND** : Functions the same as "Shuffle Albums" of the iPod
- SONG RND** : Functions the same as "Shuffle Songs" of the iPod

- To cancel repeat play or random play, select "RPT OFF" or "RND OFF."
- "ALBUM RND" is not available for some iPod.
- To return to the previous menu, press **T/P BACK**.

Changing the display information

Album name/performer → **Track title** → **Current track number with the elapsed playing time** → **Current track number with the clock time** → (back to the beginning)

Using the remote controller

- ◀ R/F ▶** : Selects track
- ◀ R/F ▶** : Fast-forwards or [Hold] reverses the track

Notice:

When operating an iPod, some operations may not be performed correctly or as intended. In this case, visit the following JVC web site: <<http://www.jvc.co.jp/english/car/>> (English website only)

Listening to the DAB tuner

Before operating, connect the JVC DAB tuner, KT-DB1000 (not supplied) to the expansion port on the rear of the unit.

Preparation: Make sure <EXT ON> is selected in the <SRC SELECT> → <EXT IN> setting. (🔍 27)

- For details, refer also to the instructions supplied with the JVC DAB tuner.

1



⇒ "DAB"

2



⇒ Search for an ensemble.

When an ensemble is tuned in, searching stops. To stop searching, press the same button again.

3



⇒ Select a service (primary or secondary) to listen to.



Manual search for an ensemble



"M" flashes, then press the button repeatedly.

Storing DAB services in memory

You can preset six DAB services (primary).

Ex.: Storing an ensemble (primary service) into the preset number "04."

1 Select a service (steps **1** to **3**, 19).



"PRESET MODE" flashes.

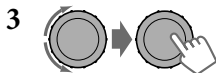

⇒ Selects preset number "04."

"P04" flashes and "MEMORY" appears.

Selecting a preset station

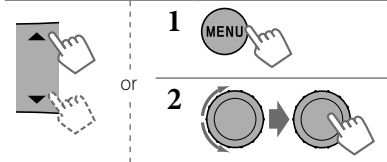

Changing the display information



Service name → Ensemble name → Channel number → Frequency → Clock → (back to the beginning)

Using the remote controller



▲ U/D ▼ : Changes the DAB preset stations

◀ R/F ▶ : Searches for DAB stations

Tracing the same programme— Alternative Frequency Reception (DAB AF)

You can keep listening to the same programme by activating the Alternative Frequency Reception.

• While receiving a DAB service:

When driving in an area where a service cannot be received, this unit automatically tunes in to another ensemble or FM Radio Data System station, broadcasting the same programme.

• While receiving an FM Radio Data System station:

When driving in an area where a DAB service is broadcasting the same programme as the FM Radio Data System station is broadcasting, this unit automatically tunes in to the DAB service.

When shipped from the factory, Alternative Frequency Reception is activated.

To deactivate the Alternative Frequency Reception, 25.

Listening to the other external components

You can connect an external component to:

- **EXT INPUT:** Expansion port on the rear of this unit using the following adapters (not supplied):

- **KS-U57**, Line Input Adapter

- **KS-U58**, AUX Input Adapter



Preparation: Make sure <EXT ON> is selected for the <SRC SELECT> → <EXT IN> setting.

(🔍 27)

- **AUX IN:** AUX (auxiliary) input jack on the control panel.

Preparation: Make sure <AUX ON> is selected for the <SRC SELECT> → <AUX IN> setting. (🔍 27)

- For details, refer also to the instructions supplied with the adapter or external components.

- 1  ⇒ "EXT INPUT" or "AUX IN"
- 2 **Turn on the connected component and start playing the source.**
- 3  ⇒ Adjust the volume.
- 4 **Adjust the sound as you want. (🔍 22)**

Connecting an external component to the AUX input jack

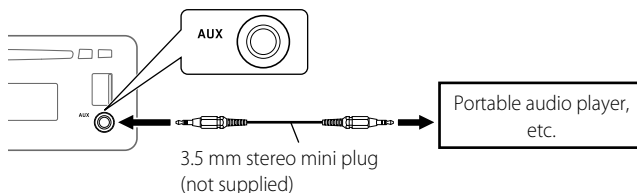

Selecting a preset sound mode

You can select a preset sound mode suitable for the music genre.



FLAT → **NATURAL** → **DYNAMIC** → **VOCAL BOOST** → **BASS BOOST** → **USER** → (back to the beginning)

While listening, you can adjust the tone level of the selected sound mode.

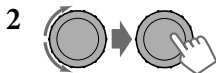

Adjust the level (-06 to +06) of the selected tone (BASS / MID / TRE).
The sound mode is automatically stored and changed to "USER."

Storing your own sound mode

You can store your own adjustments in memory.

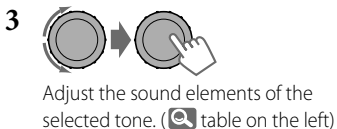
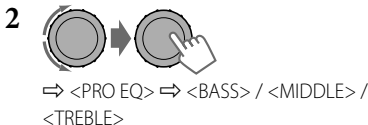

4 Repeat steps **2** and **3** to adjust other tones.
The adjustments made will be stored automatically in "USER."

The current sound mode changes to "USER" automatically.

Tone	Sound element		
	Frequency	Level	Q
BASS	60 Hz	-06 to +06	Q1.0
	80 Hz		Q1.25
	100 Hz		Q1.5
	200 Hz		Q2.0
MIDDLE	0.5 kHz	-06 to +06	Q0.75
	1.0 kHz		Q1.0
	1.5 kHz		Q1.25
	2.5 kHz		
TREBLE	10.0 kHz	-06 to +06	Q FIX
	12.5 kHz		
	15.0 kHz		
	17.5 kHz		

Menu operations

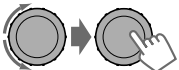

1  [Hold]	2 	3 Repeat step 2 if necessary. <ul style="list-style-type: none"> • To return to the previous menu, press T/P BACK. • To exit from the menu, press DISP or MENU.
---	--	---

Category	Menu item	Selectable setting, [Initial: <u>Underlined</u>]
DEMO	DEMO Display demonstration	<ul style="list-style-type: none"> • <u>DEMO ON</u> : Display demonstration will be activated automatically if no operation is done for about 20 seconds. • DEMO OFF : Cancels. (🔍 4)
	CLOCK SET Clock setting	— : Adjust the hour, then the minute. (🔍 4) [0:00]
CLOCK	24H/12H Time display mode	<ul style="list-style-type: none"> • <u>24 HOUR</u> : For settings, 🔍 4. • 12 HOUR
	CLOCK ADJ *1 Clock adjustment	<ul style="list-style-type: none"> • <u>AUTO</u> : The built-in clock is automatically adjusted using the CT (clock time) data in the Radio Data System signal. • OFF : Cancels.
PRO EQ	BASS	— : For settings, 🔍 22.
	MIDDLE	
	TREBLE	
DISPLAY	DIMMER	<ul style="list-style-type: none"> • <u>DIMMER AUTO</u> : Dims the display when you turn on the headlights.*2 • DIMMER ON : Dims the display and button illumination. • DIMMER OFF : Cancels.

*1 Takes effect only when CT (clock time) data is received.

*2 The illumination control lead connection is required. (See "Installation/Connection Manual.") This setting may not work correctly on some vehicles (particularly on those having a control dial for dimming). In this case, change the setting to any other than <DIMMER AUTO>.



Category	Menu item	Selectable setting, [Initial: <u>Underlined</u>]
DISPLAY	SCROLL *3	<ul style="list-style-type: none"> • SCROLL ONCE : Scrolls the displayed information once. • SCROLL AUTO : Repeats scrolling (at 5-second intervals). • SCROLL OFF : Cancels. Pressing DISP for more than one second can scroll the display regardless of the setting.
	TAG DISPLAY	<ul style="list-style-type: none"> • TAG ON : Shows the Tag information while playing MP3/WMA/WAV tracks. • TAG OFF : Cancels.
TUNER	SSM*4 Strong-station Sequential Memory	<ul style="list-style-type: none"> • SSM 01 – 06 : For settings,  7. • SSM 07 – 12 • SSM 13 – 18
	AF-REG*5 Alternative frequency/ regionalization reception	<ul style="list-style-type: none"> • AF ON : When the currently received signals become weak, the unit switches to another station (the programme may differ from the one currently received). (The AF indicator lights up.) • AF-REG ON : When the currently received signals become weak, the unit switches to another station broadcasting the same programme. (The AF and REG indicators light up.) • OFF : Cancels (not selectable when <DAB AF> is set to <AF ON>).
	PTY- STANDBY*4, *5	<ul style="list-style-type: none"> • PTY OFF, PTY codes : Activates PTY Standby Reception with one of the PTY codes ( 9).
	TA VOLUME*5 Traffic announcement volume	<ul style="list-style-type: none"> • VOLUME 00 : — – VOLUME 50 (or VOLUME 00 – VOLUME 30)*6 [VOLUME 15]
	P-SEARCH*5 Programme search	<ul style="list-style-type: none"> • SEARCH ON : Activates Programme Search. ( 9) • SEARCH OFF : Cancels.

*3 Some characters or symbols will not be shown correctly (or will be blanked) on the display.

*4 Displayed only when the source is "FM."

*5 Only for FM Radio Data System stations.

*6 Depends on the amplifier gain control.

Category	Menu item	Selectable setting, [Initial: <u>Underlined</u>]
TUNER	DAB AF *7 Alternative frequency reception	<ul style="list-style-type: none"> • AF ON : Traces the programme among DAB services and FM Radio Data System stations. (🔍 20) • AF OFF : Cancels.
	MONO *8 Monaural mode	<ul style="list-style-type: none"> • MONO ON : Activate monaural mode to improve FM reception, but stereo effect will be lost. (🔍 7) • MONO OFF : Restore the stereo effect.
	IF BAND Intermediate frequency band	<ul style="list-style-type: none"> • AUTO : Increases the tuner selectivity to reduce interference noises between adjacent stations. (Stereo effect may be lost.) • WIDE : Subject to interference noises from adjacent stations, but sound quality will not be degraded and the stereo effect will remain.
COLOR	BUTTON ZONE	COLOR 01 — : For settings, 🔍 28. COLOR 29, USER
	DISP ZONE Display zone	
	ALL ZONE	
COLOR SETUP	DAY COLOR	<ul style="list-style-type: none"> • BUTTON ZONE : For settings, 🔍 29. • DISP ZONE
	NIGHT COLOR	
	MENU COLOR	<ul style="list-style-type: none"> • ON : Changes the display and buttons (except for EQ/BASS-TRE / DISP) illumination during menu, list search and playback mode operations. • OFF : Cancels.
	RING COLOR *9	<ul style="list-style-type: none"> • ON : When a call comes in, the display will flash in blue. <ul style="list-style-type: none"> • The display will change to the original color when the call is answered or the incoming call stops. When the unit receives a text message, the display only illuminate in blue. • OFF : Cancels.

*7 Displayed only when DAB tuner is connected.

*8 Displayed only when the source is "FM."

*9 Displayed only when Bluetooth adapter, KS-BTA200 is connected.



Category	Menu item	Selectable setting, [Initial: <u>Underlined</u>]
AUDIO	FADER *10	R06 – F06 : Adjust the front and rear speaker output [00] balance.
	BALANCE *11	L06 – R06 : Adjust the left and right speaker output [00] balance.
	LOUD Loudness	• LOUD ON : Boost low and high frequencies to produce a well-balanced sound at a low volume level. • <u>LOUD OFF</u> : Cancels.
	VOL ADJUST Volume adjust	VOL ADJ -05 — : Preset the volume adjustment level of VOL ADJ +05 each source (except FM), compared to the <u>VOL ADJ 00</u> FM volume level. The volume level will automatically increase or decrease when you change the source. • Before making an adjustment, select the source you want to adjust. • "VOL ADJ FIX" appears on the display if "FM" is selected as the source.
	L/O MODE Line output mode	• SUB.W : Select if the REAR LINE OUT terminals are used for connecting a subwoofer (through an external amplifier). • <u>REAR</u> : Select if the REAR LINE OUT terminals are used for connecting the speakers (through an external amplifier).
	SUB.W FREQ *12 Subwoofer cutoff frequency	• LOW : Frequencies lower than 72 Hz are sent to the subwoofer. • <u>MID</u> : Frequencies lower than 111 Hz are sent to the subwoofer. • HIGH : Frequencies lower than 157 Hz are sent to the subwoofer.
	SUB.W LEVEL *12 Subwoofer level	SUB.W 00 — : Adjust the subwoofer output level. SUB.W 08 <u>SUB.W 04</u>

*10 If you are using a two-speaker system, set the fader level to "00."

*11 This adjustment will not affect the subwoofer output.

*12 Displayed only when <L/O MODE> is set to <SUB.W>.

Category	Menu item	Selectable setting, [Initial: <u>Underlined</u>]
AUDIO	BEEP Keypress tone	<ul style="list-style-type: none"> • <u>BEEP ON</u> : Activates the keypress tone. • <u>BEEP OFF</u> : Deactivates the keypress tone.
	TEL MUTING Telephone muting	<ul style="list-style-type: none"> • <u>MUTING 1/</u> <u>MUTING 2</u> : Select either one which mutes the sounds while using a mobile phone. • <u>MUTING OFF</u> : Cancels.
	AMP GAIN *13 Amplifier gain control	<ul style="list-style-type: none"> • <u>LOW POWER</u> : VOLUME 00 – VOLUME 30 (Select if the maximum power of each speaker is less than 50 W to prevent damaging the speakers.) • <u>HIGH POWER</u> : VOLUME 00 – VOLUME 50
SRC SELECT	AM *14 AM station	<ul style="list-style-type: none"> • <u>AM ON</u> : Enable "AM" in source selection. • <u>AM OFF</u> : Disable "AM" in source selection.
	EXT IN *15 External input	<ul style="list-style-type: none"> • <u>EXT ON</u> : Enable "EXT IN" in source selection. • <u>EXT OFF</u> : Disable "EXT IN" in source selection.
	AUX IN *16 Auxiliary input	<ul style="list-style-type: none"> • <u>AUX ON</u> : Enable "AUX IN" in source selection. • <u>AUX OFF</u> : Disable "AUX IN" in source selection.
AUDIOBOOKS	AUDIOBOOKS *17 Speed control of "Audiobooks"	<ul style="list-style-type: none"> • <u>NORMAL</u> : You can select the playback speed of the "Audiobook" sound file in your iPod. • <u>FASTER</u> • <u>SLOWER</u> : Initial selected item depends on your iPod setting.
IPOD SWITCH	IPOD SWITCH *18 iPod/iPhone control	<ul style="list-style-type: none"> • <u>HEAD MODE</u> : Controls iPod playback through the unit. • <u>IPOD MODE</u> : Controls iPod playback through the iPod/iPhone.

*13 The volume level automatically changes to "VOLUME 30" if you change to <LOW POWER> with the volume level set higher than "VOLUME 30."

*14 Displayed only when any source other than "AM" is selected.

*15 Displayed only when any source other than "EXT IN" is selected.

*16 Displayed only when any source other than "AUX IN" is selected.

*17 Displayed only when an iPod is connected and playback is controlled from the unit.

*18 Displayed only when "USB-IPOD" is selected as the source and "IPOD MODE" is available for the connected iPod/iPhone (📞 33).



Selecting the variable buttons and display color illumination

You can select your preferred color for buttons illumination (except for **EQ/BASS-TRE / DISP**) and display color separately.

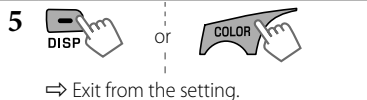
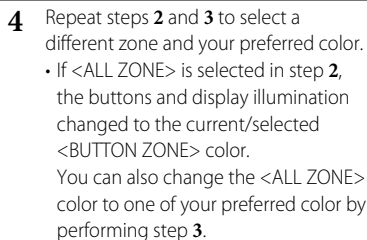
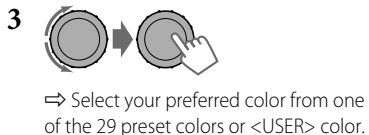
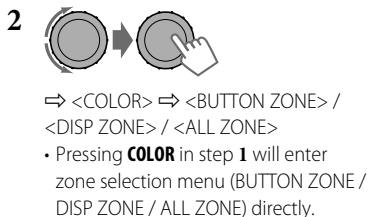
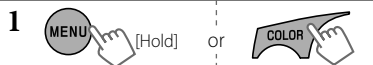
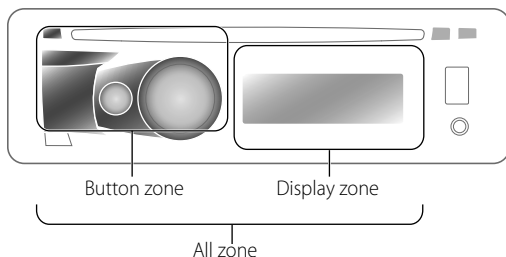



Creating your own day and night colors—USER

You can create your own colors for <DAY COLOR> and <NIGHT COLOR> to apply to button zone and display zone.

- <DAY COLOR> Displayed when <DIMMER> is set to <DIMMER OFF>.
- <NIGHT COLOR> Displayed when <DIMMER> is set to <DIMMER ON>.

Menu hierarchy		Operation	
COLOR SETUP	DAY COLOR	• BUTTON ZONE	Follow example below.
		• DISP ZONE	Press T/P BACK after step 5, then select DISP ZONE in step 2.
	NIGHT COLOR	• BUTTON ZONE	Press T/P BACK after step 5, then select NIGHT COLOR in step 2.
		• DISP ZONE	

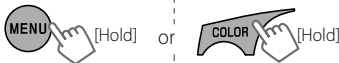
Ex.: Creating <USER> color for <BUTTON ZONE> in <DAY COLOR>.

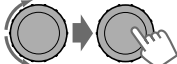

1  or 

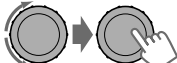
2 
 ⇒ <COLOR SETUP> ⇒ <DAY COLOR>
 ⇒ <BUTTON ZONE>
 • Pressing **COLOR** in step 1 will enter zone selection menu (BUTTON ZONE / DISP ZONE) directly.

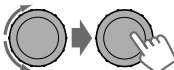
3 
 ⇒ Select a primary color.
RED ↔ GREEN ↔ BLUE ↔ (back to the beginning)

4 
 ⇒ Adjust the level of the selected primary color.
00 to 31

5 Repeat steps 3 and 4 to adjust other primary colors.

6  or 
 ⇒ Exit from the setting.

If "00" is selected for all the primary colors (as in step 4) for <DISP ZONE>, nothing appear on the display.

More about this unit

Basic operations

General

- If you turn off the power while listening to a track, playback will start from where it had been stopped previously next time you turn on the power.
- If no operation is done for about 60 seconds after pressing **MENU** button, the operation will be canceled.

Tuner operations

Storing stations in memory

- During SSM search...
 - All previously stored stations are erased and the stations are stored anew.
 - When SSM is over, the station stored in the lowest preset number will be automatically tuned in.
- When storing a station manually, the previously preset station is erased when a new station is stored in the same preset number.

FM Radio Data System operations

- Network-Tracking Reception requires two types of Radio Data System signals—PI (Programme Identification) and AF (Alternative Frequency) to work correctly.
- If a Traffic Announcement is received by TA Standby Reception, the volume level automatically changes to the preset level (TA VOLUME) if the current level is lower than the preset level.
- When Alternative Frequency Reception is activated (with AF selected), Network-Tracking Reception is also activated automatically. On the other hand, Network-Tracking Reception cannot be deactivated without deactivating Alternative Frequency Reception. (🗨️ 25)

Disc/USB operations

Caution for DualDisc playback

- The Non-DVD side of a “DualDisc” does not comply with the “Compact Disc Digital Audio” standard. Therefore, the use of Non-DVD side of a DualDisc on this product may not be recommended.

General

- This unit has been designed to reproduce CDs/CD Texts, and CD-Rs (Recordable)/CD-RWs (Rewritable) in audio CD (CD-DA), MP3 and WMA formats.
- If you change the source while listening to a disc, playback stops. Next time you select “CD” as the playback source, playback will start from where it had been stopped previously.
- When a disc is inserted upside down, “PLEASE” and “EJECT” appear alternately on the display. Press ▲ to eject the disc.
- If the ejected disc is not removed within 15 seconds, it is automatically inserted into the loading slot again to protect it from dust. Playback starts automatically.
- MP3 and WMA “tracks” (words “file” and “track” are used interchangeably) are recorded in “folders.”
- While fast-forwarding or reversing on an MP3 or WMA disc, you can only hear intermittent sounds.

Playing a CD-R or CD-RW

- Use only “finalized” CD-Rs or CD-RWs.
- This unit can only play back files of the same type as those detected first if a disc includes both audio CD (CD-DA) files and MP3/WMA files.
- This unit can play back multi-session discs; however, unclosed sessions will be skipped while playing.
- Some CD-Rs or CD-RWs may not play back on this unit because of their disc characteristics, or for the following reasons:
 - Discs are dirty or scratched.
 - Moisture condensation has occurred on the lens inside the unit.
 - The pickup lens inside the unit is dirty.
 - The files on the CD-R/CD-RW are written using the “Packet Write” method.
 - There are improper recording conditions (missing data, etc.) or media conditions (stained, scratched, warped, etc.).
- CD-RWs may require a longer readout time since the reflectance of CD-RWs is lower than that of regular CDs.
- Do not use the following CD-Rs or CD-RWs:
 - Discs with stickers, labels, or a protective seal stuck to the surface.
 - Discs on which labels can be directly printed by an ink jet printer.Using these discs under high temperature or high humidity may cause malfunctions or damage to the unit.

Playing an MP3/WMA disc

- This unit can play back MP3/WMA files with the extension code <mp3> or <wma> (regardless of the letter case—upper/lower).
- This unit can show the names of albums, artists (performer), and Tag (Version 1.0, 1.1, 2.2, 2.3, or 2.4) for MP3 files and for WMA files.
- This unit can display only one-byte characters. No other characters can be correctly displayed.

- This unit can play back MP3/WMA files meeting the conditions below:
 - Bit rate of MP3/WMA: 32 kbps — 320 kbps
 - Sampling frequency of MP3:
 - 32 kHz, 44.1 kHz, 48 kHz (for MPEG-1)
 - 16 kHz, 22.05 kHz, 24 kHz (for MPEG-2)
 - Sampling frequency of WMA:
 - 22.05 kHz, 32 kHz, 44.1 kHz, 48 kHz
 - Disc format: ISO 9660 Level 1/Level 2, Romeo, Joliet, Windows extension
- The maximum number of characters for file/folder names (includes 4 extension characters—<mp3> or <wma>).
 - ISO 9660 Level 1: up to 12 characters
 - ISO 9660 Level 2: up to 31 characters
 - Romeo: up to 64 characters
 - Joliet: up to 32 characters
 - Windows extension: up to 64 characters
- This unit can recognize a total of 512 files, 255 folders, and 8 hierarchical levels.
- This unit can play back files recorded in VBR (variable bit rate).

Files recorded in VBR have a discrepancy in the elapsed time display, and do not show the actual elapsed time. In particular, this difference becomes noticeable after performing the search function.
- This unit cannot play back the following files:
 - MP3 files encoded in MP3i and MP3 PRO format.
 - MP3 files encoded in an inappropriate format.
 - MP3 files encoded with Layer 1/2.
 - WMA files encoded in lossless, professional, and voice format.
 - WMA files which are not based upon Windows Media® Audio.
 - WMA files copy-protected with DRM.
 - Files which have data such as AIFF, ATAC3, etc.
- The search function works but search speed is not constant.



Playing MP3/WMA tracks from a USB device

- While playing from a USB device, the playback order may differ from other players.
 - This unit may be unable to play back some USB devices or some files due to their characteristics or recording conditions.
 - Depending on the shape of the USB devices and connection ports, some USB devices may not be attached properly or the connection might be loose.
 - Connect one USB mass storage class device to the unit at a time. Do not use a USB hub.
 - If the connected USB device does not have the correct files, "CANNOT PLAY" appears.
 - This unit can show Tag (Version 1.0, 1.1, 2.2, 2.3, or 2.4) for MP3 files and for WMA files.
 - This unit can play back MP3/WMA files meeting the conditions below:
 - Bit rate of MP3/WMA: 32 kbps — 320 kbps
 - Sampling frequency of MP3:
 - 32 kHz, 44.1 kHz, 48 kHz (for MPEG-1)
 - 16 kHz, 22.05 kHz, 24 kHz (for MPEG-2)
 - Sampling frequency of WMA:
 - 22.05 kHz, 32 kHz, 44.1 kHz, 48 kHz
 - This unit can play back MP3 files recorded in VBR (variable bit rate).
 - The maximum number of characters for:
 - Folder names : 32 characters
 - File names : 32 characters
 - MP3 Tag : 64 characters
 - WMA Tag : 32 characters
 - This unit can recognize a total of 5 000 files, 255 folders (255 files per folder including folder without unsupported files), and of 8 hierarchies.
 - This unit does not support SD card reader.
 - This unit cannot recognize a USB device whose rating is other than 5 V and exceeds 500 mA.
- USB devices equipped with special functions such as data security functions cannot be used with the unit.
 - Do not use a USB device with 2 or more partitions.
 - This unit may not recognized a USB device connected through a USB card reader.
 - This unit may not play back files in a USB device properly when using a USB extension cord.
 - This unit cannot play back the following files:
 - MP3 files encoded in MP3i and MP3 PRO format.
 - MP3 files encoded in an inappropriate format.
 - MP3 files encoded with Layer 1/2.
 - WMA files encoded in lossless, professional, and voice format.
 - WMA files which are not based upon Windows Media® Audio.

Bluetooth operations

- While driving, do not perform complicated operation such as dialing the numbers, using phone book, etc. When you perform these operations, stop your car in a safe place.
- Some Bluetooth devices may not be connected to this unit depending on the Bluetooth version of the device.
- This unit may not work for some Bluetooth devices.
- Connecting condition may vary depending on the circumstances around you.
- When the unit is turned off, the device is disconnected.

iPod/iPhone operations

- You can control the following types of iPods/iPhone:
 - iPod with video (5th Generation) *1
 - iPod classic *1, *2
 - iPod nano
 - iPod nano (2nd Generation)
 - iPod nano (3rd Generation) *1, *2
 - iPod nano (4th Generation) *1, *2
 - iPod nano (5th Generation) *1, *2
 - iPod touch *1, *2
 - iPod touch (2nd Generation) *1, *2
 - iPhone/iPhone 3G/iPhone 3GS *1, *2

*1 *It is not possible to browse video files on the "Videos" menu.*

*2 <IPOD MODE> is available (📷 27).

- If the iPod does not play correctly, please update your iPod software to the latest version. For details about updating your iPod, visit <<http://www.apple.com>>.
- When you turn on this unit, the iPod is charged through this unit.
- iPod shuffle cannot be used with this unit.
- The song order displayed on the selection menu of this unit may differ from that of the iPod.
- The text information may not be displayed correctly:
 - Some characters such as accented letters cannot be shown correctly on the display.
 - Communication between the iPod and the unit is not stable.
- If the text information includes more than 11 characters, it scrolls on the display. This unit can display up to 64 characters.

DAB operations

- Only the primary DAB service can be preset even when you store a secondary service.
- A previously preset DAB service is erased when a new DAB service is stored in the same preset number.

JVC bears no responsibility for any loss of data in an iPod/iPhone and/or USB mass storage class device while using this System.

Maintenance

How to clean the connectors

Frequent detachment will deteriorate the connectors.

To minimize this possibility, periodically wipe the connectors with a cotton swab or cloth moistened with alcohol, being careful not to damage the connectors.

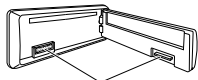

Connectors

Moisture condensation

Moisture may condense on the lens inside the unit in the following cases:

- After starting the heater in the car.
- If it becomes very humid inside the car.

Should this occur, the unit may malfunction. In this case, eject the disc and leave the unit turned on for a few hours until the moisture has evaporated.

How to handle discs

When removing a disc from its case, press down the center holder of the case and lift the disc out, holding it by the edges.

- Always hold the disc by the edges. Do not touch its recording surface.

When storing a disc in its case, gently insert the disc around the center holder (with the printed surface facing up).

- Make sure to store discs in cases after use.

Center holder



To keep discs clean

A dirty disc may not play correctly. If a disc does become dirty, wipe it with a soft cloth in a straight line from center to edge.

- Do not use any solvents (for example, conventional record cleaner, spray, thinner, benzene, etc.) to clean discs.









To play new discs

New discs may have some rough spots around the inner and outer edges. If such a disc is used, this unit may reject the disc.

To remove these rough spots, rub the edges with a pencil or ball-point pen, etc.



Do not use the following discs:

Single CD (8 cm disc)	Warped disc
	
Sticker and sticker residue	Stick-on label
	
Unusual shape	C-thru Disc (semitransparent disc)
	
Transparent or semitransparent parts on its recording area	
	

Troubleshooting

	Symptom	Remedy/Cause
General	Sound cannot be heard from the speakers.	<ul style="list-style-type: none"> • Adjust the volume to the optimum level. • Make sure the unit is not muted/paused (🔍 6). • Check the cords and connections.
	"PROTECT" appears on the display and no operations can be done.	<p>Check to be sure the terminals of the speaker leads are covered with insulating tape properly, then reset the unit (🔍 3).</p> <p>If "PROTECT" does not disappear, consult your JVC IN-CAR ENTERTAINMENT dealer or a company supplying kits.</p>
	The unit does not work at all.	Reset the unit. (🔍 3)
	"AUX IN" cannot be selected.	Check the <SRC SELECT> → <AUX IN> setting. (🔍 27)
	Nothing appear on the display.	Check the <USER> color settings (🔍 29).
FM/AM	SSM automatic presetting does not work.	Store stations manually.
	Static noise while listening to the radio.	Connect the aerial firmly.
	"AM" cannot be selected.	Check the <SRC SELECT> → <AM> setting. (🔍 27)
Disc playback	Disc cannot be played back.	Insert the disc correctly.
	<ul style="list-style-type: none"> • CD-R/CD-RW cannot be played back. • Tracks on the CD-R/CD-RW cannot be skipped. 	<ul style="list-style-type: none"> • Insert a finalized CD-R/CD-RW. • Finalize the CD-R/CD-RW with the component which you used for recording.
	Disc can neither be played back nor ejected.	<ul style="list-style-type: none"> • Unlock the disc. (🔍 10) • Eject the disc forcibly. (🔍 3)
	Disc sound is sometimes interrupted.	<ul style="list-style-type: none"> • Stop playback while driving on rough roads. • Change the disc. • Check the cords and connections.
	"NO DISC" appears on the display.	Insert a playable disc into the loading slot.
	"PLEASE" and "EJECT" appear alternately on the display.	Press ▲, then insert a disc correctly.



	Symptom	Remedy/Cause
MP3/WMA playback	Disc cannot be played back.	<ul style="list-style-type: none"> • Use a disc with MP3/WMA tracks recorded in a format compliant with ISO 9660 Level 1, Level 2, Romeo, or Joliet. • Add the extension code <.mp3> or <.wma> to the file names.
	Noise is generated.	Skip to another track or change the disc. (Do not add the extension code <.mp3> or <.wma> to non-MP3 or WMA tracks.)
	A longer readout time is required ("READING" keeps flashing on the display).	Do not use too many hierarchical levels and folders.
	Tracks do not play back in the order you have intended them to play.	The playback order is determined when the files are recorded.
	The elapsed playing time is not correct.	This sometimes occurs during playback. This is caused by how the tracks are recorded on the disc.
	"NO FILE" appears on the display.	Selected folder is an empty folder *1. Select another folder that contains MP3/WMA tracks.
	"NOT SUPPORT" appears on the display and track skips.	Skip to the next track encoded in an appropriate format or to the next non-copy-protected WMA track.
USB device playback	The correct characters are not displayed (e.g. album name).	This unit can only display letters (upper case), numbers, and a limited number of symbols.
	Noise is generated.	The track played back is not an MP3/WMA track. Skip to another file. (Do not add the extension code <.mp3> or <.wma> to non-MP3 or WMA tracks.)
	"READING" keeps flashing on the display.	<ul style="list-style-type: none"> • Readout time varies depending on the USB device. • Do not use too many hierarchy or folders. • Turn off the power then on again. • Reattach the USB device again.
	"NO FILE" appears on the display.	Selected folder is an empty folder *1. Select another folder that contains MP3/WMA tracks.
	"NOT SUPPORT" appears on the display and track skips.	Skip to the next track encoded in an appropriate format or to the next non-copy-protected WMA track.

*1 Folder that is physically empty or folder that contains data but does not contain valid MP3/WMA track.

	Symptom	Remedy/Cause
USB device playback	Tracks/folders are not played back in the order you have intended.	The playback order is determined by the write-in time stamp. The first track/folder written into the USB device will be the first track/folder for playback.
	<ul style="list-style-type: none"> • "CANNOT PLAY" flashes on the display. • "NO USB" appears on the display. • The unit cannot detect the USB device. 	<ul style="list-style-type: none"> • Attach a USB device that contains tracks encoded in an appropriate format. • Reattach the USB device again.
	While playing a track, sound is sometimes interrupted.	The MP3/WMA tracks have not been properly copied into the USB device. Copy MP3/WMA tracks again into the USB device, and try again.
	Correct characters are not displayed (e.g. album name).	This unit can only display letters (upper case), numbers, and a limited number of symbols.
Bluetooth *2	Bluetooth device does not detect the unit.	The unit can be connected with one Bluetooth mobile phone and one Bluetooth audio device at a time. While connecting a device, this unit cannot be detected from another device. Disconnect currently connected device and search again.
	The unit does not detect the Bluetooth device.	<ul style="list-style-type: none"> • Check the Bluetooth setting of the device. • Search from the Bluetooth device. After the device detects the unit, select "OPEN" on the unit to connect the device. (📄 13)
	The unit does not make pairing with the Bluetooth device.	<ul style="list-style-type: none"> • Enter the same PIN code for both the unit and target device. • Select the device name from "SPECIAL," then try to connect again. (📄 13) • Try to pair/connect from the Bluetooth device.
	Echo or noise occurs.	Adjust the microphone unit position.
	Phone sound quality is poor.	<ul style="list-style-type: none"> • Reduce the distance between the unit and the Bluetooth mobile phone. • Move the car to a place where you can get a better signal reception.

*2 For Bluetooth operations, refer also to the instructions supplied with the Bluetooth Adapter.



	Symptom	Remedy/Cause
Bluetooth	The sound is interrupted or skipped during playback of a Bluetooth audio device.	<ul style="list-style-type: none"> • Reduce the distance between the unit and the Bluetooth audio device. • Disconnect the device connected for "BT-PHONE." • Turn off, then turn on the unit. • (When the sound is not yet restored,) connect the device again.
	The connected audio device cannot be controlled.	Check whether the connected audio device supports AVRCP (Audio/Video Remote Control Profile).
iPod/iPhone	The iPod does not turn on or does not work.	<ul style="list-style-type: none"> • Check the connecting cable and its connection. • Update the firmware version of the iPod/iPhone. • Charge the battery of the iPod/iPhone. • Reset the iPod/iPhone. • Check whether <IPOD SWITCH> setting is appropriate (🔍 27).
	The sound is distorted.	Deactivate the equalizer either on this unit or the iPod/iPhone.
	A lot of noise is generated.	Turn off (uncheck) the "VoiceOver" feature of the iPod. For details, visit < http://www.apple.com >.
	Playback stops.	The headphones are disconnected during playback. Restart the playback operation (🔍 18).
	"CANNOT PLAY" appears on the display.	No tracks are stored. Import tracks to the iPod/iPhone.
"RESTRICTED" appears on the display.	Check whether the connected iPod/iPhone is compatible with this unit (🔍 33).	

	Symptom	Remedy/Cause
DAB	"noSIGNAL" appears on the display.	Move to an area with stronger signals.
	"RESET 8" appears on the display.	Connect this unit and the DAB tuner correctly and reset the unit (🔍 3).
	"ANTENNA NG" appears on the display.	Check the cords and connections.
	The DAB tuner does not work at all.	Reconnect this unit and the DAB tuner correctly and reset the unit (🔍 3).

- Microsoft and Windows Media are either registered trademarks or trademarks of Microsoft Corporation in the United States and/or other countries.
- The Bluetooth word mark and logos are owned by the Bluetooth SIG, Inc. and any use of such marks by Victor Company of Japan, Limited (JVC) is under license. Other trademarks and trade names are those of their respective owners.
- "Made for iPod" means that an electronic accessory has been designed to connect specifically to iPod and has been certified by the developer to meet Apple performance standards.
- "Works with iPhone" means that an electronic accessory has been designed to connect specifically to iPhone and has been certified by the developer to meet Apple performance standards.
- Apple is not responsible for the operation of this device or its compliance with safety and regulatory standards.
- iPod is a trademark of Apple Inc., registered in the U.S. and other countries.
- iPhone is a trademark of Apple Inc.

Specifications

AUDIO AMPLIFIER SECTION	Maximum Power Output:	Front/Rear:	50 W per channel	
	Continuous Power Output (RMS):	Front/Rear:	20 W per channel into 4 Ω , 40 Hz to 20 000 Hz at no more than 1% total harmonic distortion.	
	Load Impedance:		4 Ω (4 Ω to 8 Ω allowance)	
	Tone Control Range:	Bass:	± 12 dB (60 Hz, 80 Hz, 100 Hz, 200 Hz) Q1.0, Q1.25, Q1.5, Q2.0	
		Middle:	± 12 dB (0.5 kHz, 1.0 kHz, 1.5 kHz, 2.5 kHz) Q0.75, Q1.0, Q1.25	
		Treble:	± 12 dB (10.0 kHz, 12.5 kHz, 15.0 kHz, 17.5 kHz) Q (Fixed)	
	Frequency Response:		40 Hz to 20 000 Hz	
	Signal-to-Noise Ratio:		70 dB	
	Line-Out Level/Impedance:		2.5 V/20 k Ω load (full scale)	
	Subwoofer-Out Level/Impedance:		2.5 V/20 k Ω load (full scale)	
	Output Impedance:		1 k Ω	
Other Terminal:	AUX (auxiliary) input jack, USB input jack, Aerial input, Expansion port, Steering wheel remote input			
TUNER SECTION	Frequency Range:	FM:	87.5 MHz to 108.0 MHz	
		AM:	MW: 522 kHz to 1 620 kHz LW: 144 kHz to 279 kHz	
	FM Tuner:	Usable Sensitivity:	9.3 dBf (0.8 μ V/75 Ω)	
		50 dB Quieting Sensitivity:	16.3 dBf (1.8 μ V/75 Ω)	
		Alternate Channel Selectivity (400 kHz):	65 dB	
		Frequency Response:	40 Hz to 15 000 Hz	
		Stereo Separation:	40 dB	
	MW Tuner:	Sensitivity:	20 μ V	
		Selectivity:	40 dB	
	LW Tuner:	Sensitivity:	50 μ V	

CD PLAYER SECTION	Type:		Compact disc player	
	Signal Detection System:		Non-contact optical pickup (semiconductor laser)	
	Number of Channels:		2 channels (stereo)	
	Frequency Response:		5 Hz to 20 000 Hz	
	Dynamic Range:		96 dB	
	Signal-to-Noise Ratio:		98 dB	
	Wow and Flutter:		Less than measurable limit	
	MP3 Decoding Format: (MPEG1/2 Audio Layer 3)		Max. Bit Rate: 320 kbps	
	WMA (Windows Media® Audio) Decoding Format:		Max. Bit Rate: 320 kbps	
USB SECTION	USB Standard:		USB 1.1, USB 2.0	
	Data Transfer Rate (Full Speed):		Max. 12 Mbps	
	Compatible Device:		Mass storage class	
	Compatible File System:		FAT 32/16/12	
	Playable Audio Format:		MP3/WMA	
	Max. Current:		DC 5 V  500 mA	
GENERAL	Power Requirement:	Operating Voltage:	DC 14.4 V (11 V to 16 V allowance)	
	Grounding System:		Negative ground	
	Allowable Operating Temperature:		0°C to +40°C	
	Dimensions (W × H × D): (approx.)	Installation Size:	182 mm × 52 mm × 160 mm	
		Panel Size:	188 mm × 58 mm × 12 mm	
Mass:		1.3 kg (excluding accessories)		

Design and specifications are subject to change without notice.



■ The countries where you may use the Bluetooth® function

- Die Länder, in denen Sie die Bluetooth® Funktion verwenden können
- Pays où vous pouvez utiliser la fonction Bluetooth®
- De landen waar u de Bluetooth®-functie mag gebruiken
- Países en los que se puede utilizar la función Bluetooth®
- Paesi nei quali è possibile utilizzare la funzione Bluetooth®
- Länder där du kan använda Bluetooth®-funktionen
- Lande, hvor du kan bruge Bluetooth®-funktionerne
- Land hvor du kan bruke Bluetooth®-funksjonen
- Maat, joissa voi käyttää Bluetooth®-toimintoa
- Países onde pode usar a função Bluetooth®
- Οι χώρες όπου μπορείτε να χρησιμοποιήσετε τη λειτουργία Bluetooth®
- Страны, где можно воспользоваться функцией Bluetooth®
- Země, ve kterých můžete využívat funkci Bluetooth®
- Azok az országok, amelyekben használhatjuk a Bluetooth®-funkciót
- Kraje, w których można używać funkcji Bluetooth®
- Države, kjer lahko uporabljate funkcijo Bluetooth®
- Krajiny, v ktorých môžete využívať funkciu Bluetooth®
- Valstis, kur jūs varat izmantot Bluetooth® funkciju
- Šalys, kuriose galite naudotis „Bluetooth®“ funkcija
- Il-pajjiżi fejn tista' tuża l-funzjoni Bluetooth®
- Lönd þar sem hægt er að nota Bluetooth®
- Riigid, kus on võimalik kasutada Bluetooth® funktsiooni
- Bluetooth® fonksiyonunu kullanabileceğiniz ülkeler
- Na tíortha inar féidir leat feidhmiú Bluetooth® a úsáid
- Länner an denen der d'Bluetooth® Funktioun benotze könnt.
- Ở những quốc gia mà bạn có thể sử dụng chức năng Bluetooth®
- Els països on podrà fer servir la funció Bluetooth®
- Zemlje u kojima je dozvoljena upotreba Bluetooth® funkcije.
- Zemlje u kojima možete koristiti Bluetooth® funkciju
- Zemlje u kojima je dopušteno koristiti Bluetooth®.
- Земљи каде можете да ја користите функцијата Bluetooth®
- Страните, в които можете да ползвате функцията Bluetooth®
- Tärile in care puteți utiliza funcția Bluetooth®
- Die lande waar u die Bluetooth®-funksie kan gebruik
- Amazwe lapho ungasebenzisa khona uhlelo lwe-Bluetooth®
- Negara-negara yang membolehkan penggunaan fungsi Bluetooth®
- Negara-negara yang anda boleh menggunakan fungsi Bluetooth®
- 您能够使用 Bluetooth® 功能的国家
- 您能夠使用 Bluetooth® 功能的國家

■ המדינות שבהן באפשרותך להשתמש ב־Bluetooth®
■ الدول التي يمكنك استخدام وظيفة Bluetooth® فيها

Country
Andorra
الإمارات العربية المتحدة
Australia
Österreich
Bosna i Hercegovina
Belgien Belgique
България
Canada
Schweiz Suisse
Κύπρος Kıbrıs
Česká republika
Deutschland
Danmark
Eesti
España
Suomi Finland
France
United Kingdom
Ελλάδα
Hong Kong 香港 香港
Hrvatska
Magyarország
Indonesia
Ireland Éire
ישראל إسرائيل
Ísland
Italia
Lichtenstein
Lietuva

Country
Luxemburg Luxembourg Lëtzebuerg
Latvija
Monaco
Crna Gora
Македонија
Malta
Nederland
Norge
New Zealand
Polska
Portugal
România
Srbija
Россия
Sverige
Singapore 新加坡 Singapura
Slovenija
Slovensko
Türkiye
台灣
United States of America
Vietnam Việt Nam
South Africa ENingizimu Afrika Suid-Afrika

Having TROUBLE with operation?

Please reset your unit

Refer to page of How to reset your unit

Vous avez des PROBLÈMES de fonctionnement?

Réinitialisez votre appareil

Référez-vous à la page intitulée Comment réinitialiser votre appareil

Dear Customer,

This apparatus is in conformance with the valid European directives and standards regarding electromagnetic compatibility and electrical safety.

European representative of Victor Company of Japan, Limited is:

JVC Technical Services Europe GmbH
Postfach 10 05 04
61145 Friedberg
Germany

Cher(e) client(e),

Cet appareil est conforme aux directives et normes européennes en vigueur concernant la compatibilité électromagnétique et à la sécurité électrique.

Représentant européen de la société Victor Company of Japan, Limited:

JVC Technical Services Europe GmbH
Postfach 10 05 04
61145 Friedberg
Allemagne

JVC



EN, FR

© 2009 Victor Company of Japan, Limited

1209DTSMDTJEIN

JVC KD-R611

Installation/Connection Manual

Manuel d'installation/raccordement

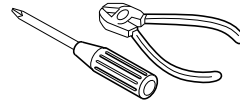

GET0640-010A
[E/EU]

1209DTSMDTJEIN
EN, FR

© 2009 Victor Company of Japan, Limited

ENGLISH / FRANÇAIS

You need the installation kits which corresponds to your car. / Vous avez besoin des kits d'installation correspondants à votre voiture.

Check the battery system in your car / Vérifiez le système de batterie de votre voiture

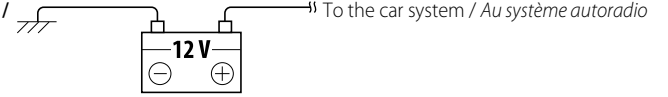

12 V DC, NEGATIVE ground / 12 V CC, masse NÉGATIVE

WARNINGS / AVERTISSEMENTS

- To prevent short circuits:
 - Disconnect the battery's negative terminal and make all electrical connections before installing the unit.
 - Cover the terminals of the UNUSED leads with insulating tape.
- Be sure to ground this unit to the car's chassis again after installation.
- Replace the fuse with one of the specified rating.
- Connect speakers with a maximum power of more than 50 W (impedance of 4 Ω to 8 Ω). Otherwise, change the <AMP GAIN> setting. (See page 27 of the INSTRUCTIONS.)
- The heat sink becomes very hot after use. Be careful not to touch it when removing this unit.

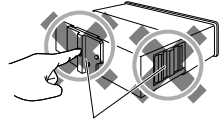

Heat sink / Dissipateur de chaleur

- Pour éviter les courts-circuits:
 - Déconnectez la borne négative de la batterie et réalisez toutes les connexions avant d'installer l'appareil.
 - Recouvrez les prises des fils NON UTILISÉS avec du ruban isolant.
- Assurez-vous de raccorder de nouveau la mise à la masse de cet appareil au châssis de la voiture après l'installation.
- Remplacer le fusible par un de la valeur précisée.
- Connectez des enceintes avec une puissance maximum de 50 W (impédance de 4 Ω à 8 Ω). Sinon, changez le réglage <AMP GAIN>. (Voir la page 27 du MANUEL D'INSTRUCTIONS.)
- Le dissipateur de chaleur devient très chaud après usage. Faire attention de ne pas le toucher en retirant cet appareil.

PRECAUTIONS on power supply and speaker connections

- DO NOT connect the speaker leads of the power cord to the car battery; otherwise, the unit will be seriously damaged.
- BEFORE connecting the speaker leads of the power cord to the speakers, check the speaker wiring in your car.

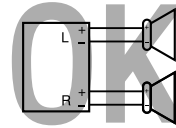
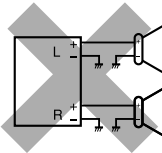
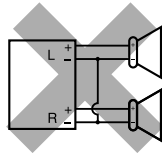

PRECAUTIONS sur l'alimentation et la connexion des enceintes

- NE CONNECTEZ PAS les fils d'enceintes du cordon d'alimentation à la batterie; sinon, l'appareil serait sérieusement endommagé.
- AVANT de connecter les fils d'enceintes du cordon d'alimentation aux enceintes, vérifiez le câblage des enceintes de votre voiture.

INSTALLATION / INSTALLATION

The following illustration shows a typical installation. If you have any questions or require information regarding installation kits, consult your JVC IN-CAR ENTERTAINMENT dealer or a company supplying kits.

L'illustration suivante est un exemple d'installation typique. Si vous avez des questions ou avez besoin d'information sur des kits d'installation, consulter votre revendeur d'autoradios JVC.

In-dash mounting / Montage encastré

-
-
- Do the required electrical connections (see page 2). Réalisez les connexions électriques (voir page 2).

Install the unit at an angle of less than 30°. Installez l'appareil avec un angle de moins de 30°.

Bend the appropriate tabs to hold the sleeve firmly in place. Tordez les languettes appropriées pour maintenir le manchon en place.

Part list / Liste de pièces

- Ⓐ Hard case / Etui de transport (x1)
- Ⓑ Control panel / Panneau de commande (x1)
- Ⓒ Sleeve / Manchon (x1)
- Ⓓ Trim plate / Plaque d'assemblage (x1)
- Ⓔ Power cord / Cordon d'alimentation (x1)
- Ⓕ Handles / Poignées (x2)

When installing the unit without using the sleeve / Lors de l'installation de l'appareil scans utiliser de manchon

Flat head screws (M5 × 8 mm) / Vis à tête plate (M5 × 8 mm) *2

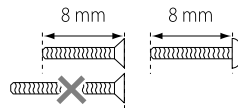
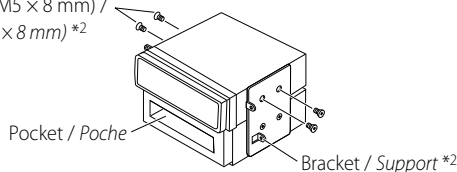

- *1 When you stand the unit, be careful not to damage the fuse on the rear.
- *2 Not supplied for this unit.

Removing the unit / Retrait de l'appareil

Release the rear section first... / Ouvrez la section arrière en premier...

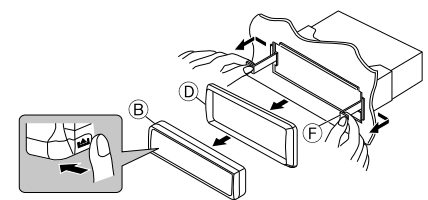

- *1 Lorsque vous mettez l'appareil à la verticale, faire attention de ne pas endommager le fusible situé sur l'arrière.
- *2 Non fourni avec cet appareil.

TROUBLESHOOTING / EN CAS DE DIFFICULTES

- The fuse blows.** ⇒ Are the red and black leads connected correctly?
- Power cannot be turned on.** ⇒ Is the yellow lead connected?
- No sound from the speakers.** ⇒ Is the speaker output lead short-circuited?
- "PROTECT" appears on the display and no operation can be done.** ⇒ Is the speaker output lead short-circuited or touches the chassis of the car/head unit? Have you reset your unit?
- Sound is distorted.** ⇒ Is the speaker output lead grounded? Are the "-" terminals of L and R speakers grounded in common?
- Noise interfere with sounds.** ⇒ Is the rear ground terminal connected to the car's chassis using shorter and thicker cords?
- This unit becomes hot.** ⇒ Is the speaker output lead grounded? Are the "-" terminals of L and R speakers grounded in common?
- This unit does not work at all.** ⇒ Have you reset your unit?

- Le fusible saute.** ⇒ Les fils rouge et noir sont-ils raccordés correctement?
- L'appareil ne peut pas être mise sous tension.** ⇒ Le fil jaune est-elle raccordée?
- Pas de son des enceintes.** ⇒ Le fil de sortie d'enceinte est-il court-circuité?
- "PROTECT" apparaît sur l'affichage et aucune opération ne peut être réalisée.** ⇒ Est-ce qu'un fil de sortie d'enceinte est court-circuité ou touche le châssis de la voiture/appareil principal? Avez-vous réinitialisé votre appareil?
- Le son est déformé.** ⇒ Le fil de sortie d'enceinte est-il à la masse? Les bornes "-" des enceintes gauche et droit sont-elles mises ensemble à la masse?
- Interférence avec les sons.** ⇒ La prise arrière de mise à la terre est-elle connectée au châssis de la voiture avec un cordon court et épais?
- Cet appareil devient chaud.** ⇒ Le fil de sortie d'enceinte est-il à la masse? Les bornes "-" des enceintes gauche et droit sont-elles mises ensemble à la masse?
- Cet appareil ne fonctionne pas du tout.** ⇒ Avez-vous réinitialisé votre appareil?

ELECTRICAL CONNECTIONS / RACCORDEMENTS ELECTRIQUES

Connecting the external amplifiers or subwoofer / Connexion d'amplificateurs extérieurs ou d'un caisson de grave

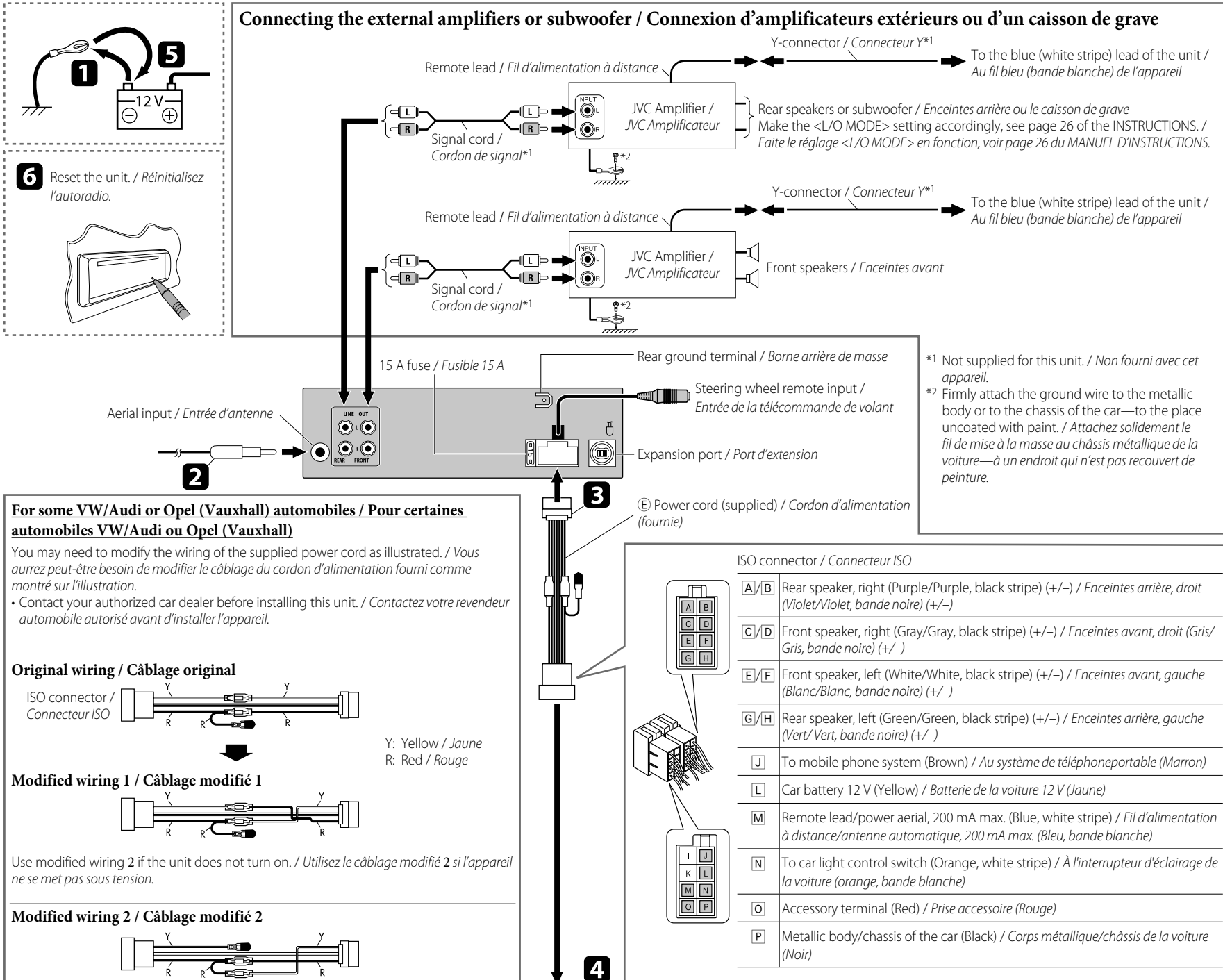

For some VW/Audi or Opel (Vauxhall) automobiles / Pour certaines automobiles VW/Audi ou Opel (Vauxhall)

You may need to modify the wiring of the supplied power cord as illustrated. / Vous aurez peut-être besoin de modifier le câblage du cordon d'alimentation fourni comme montré sur l'illustration.

• Contact your authorized car dealer before installing this unit. / Contactez votre revendeur automobile autorisé avant d'installer l'appareil.

Original wiring / Câblage original



Y: Yellow / Jaune
R: Red / Rouge

Modified wiring 1 / Câblage modifié 1

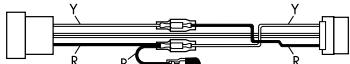

Use modified wiring 2 if the unit does not turn on. / Utilisez le câblage modifié 2 si l'appareil ne se met pas sous tension.

Modified wiring 2 / Câblage modifié 2

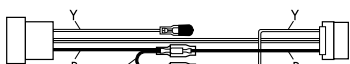

IMPORTANT/IMPORTANT: A custom wiring harness (separately purchased) which is suitable for your car is recommended for connection between the unit and your car. / Un faisceau de câbles personnalisé (vendu séparément) correspondant à votre voiture est recommandé pour raccorder l'appareil et votre voiture.

(A) If your car has an ISO terminal / Si votre voiture possède une prise ISO

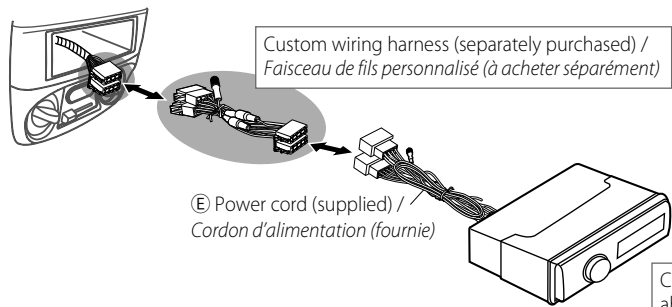

(B) If your car does NOT have an ISO terminal / Si votre voiture ne possède pas de prise ISO

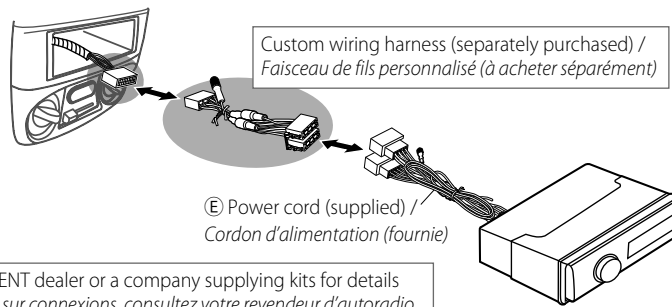

Consult your JVC IN-CAR ENTERTAINMENT dealer or a company supplying kits for details about connection. / Pour en savoir plus sur connexions, consultez votre revendeur d'autoradio JVC ou une compagnie fournissant des kits.

Connecting the external components in series / Connexion d'appareils extérieurs en série

When connecting the external components, refer also to the manuals supplied for the components and adapter. / Lors de la connexion des appareils extérieurs, référez-vous aussi aux manuels fournis avec les appareils et les adaptateurs.

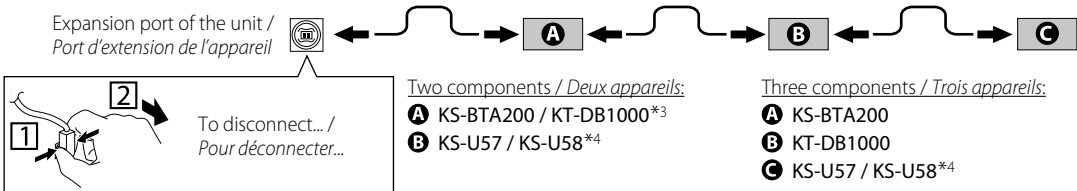

Caution / Precaution:

Before connecting the external components, make sure that the unit is turned off. / Avant de connecter les appareils extérieurs, assurez-vous que l'appareil est hors tension.

You can connect the JVC DAB tuner (KT-DB1000) or the following components through the various JVC adapters to the expansion port. / Vous pouvez connecter le tuner DAB JVC (KT-DB1000) ou les appareils suivants à l'aide de divers adaptateur JVC au port d'extension.

• Connection cords may need to be purchased separately. / Vous pouvez avoir besoin d'acheter certains cordons de connexion séparément.

Component / Appareil	Adapter / Adaptateur	Model name / Nom du modèle
Bluetooth device / Périphérique Bluetooth	Bluetooth adapter / Adaptateur Bluetooth	KS-BTA200
Portable audio player with line output jacks / Lecteur audio portable avec prises de sortie de ligne	Line input adapter / Adaptateur d'entrée de ligne	KS-U57
Portable audio player with 3.5 mm stereo mini jack / Lecteur audio portable avec mini fiche stéréo de 3,5 mm	AUX input adapter / Adaptateur d'entrée auxiliaire	KS-U58

*3 To use these components, set the external input setting correctly (see page 27 of the INSTRUCTIONS). / Pour utiliser ces appareils, réglez l'entrée extérieure correctement (voir page 27 du MANUEL D'INSTRUCTIONS).

*4 If KS-BTA200 is available, connect it to position A and connect KT-DB1000 to position B. / Si vous disposez du KS-BTA200, connectez-le à la position A et connectez le KT-DB1000 à la position B.

Free Manuals Download Website

<http://myh66.com>

<http://usermanuals.us>

<http://www.somanuals.com>

<http://www.4manuals.cc>

<http://www.manual-lib.com>

<http://www.404manual.com>

<http://www.luxmanual.com>

<http://aubethermostatmanual.com>

Golf course search by state

<http://golfingnear.com>

Email search by domain

<http://emailbydomain.com>

Auto manuals search

<http://auto.somanuals.com>

TV manuals search

<http://tv.somanuals.com>