

JVC



ENGLISH

ESPAÑOL

FRANÇAIS

CD RECEIVER

KD-AR260/KD-G210

RECEPTOR CON CD

KD-AR260/KD-G210

RECEPTEUR CD

KD-AR260/KD-G210

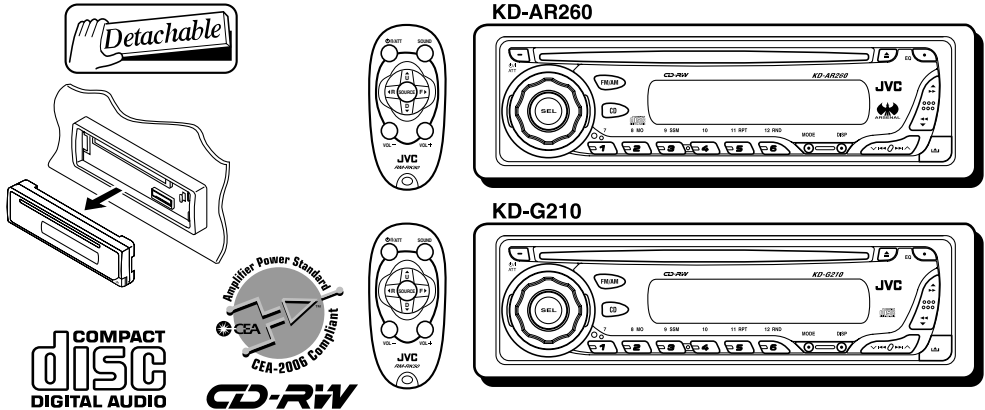

- This unit is equipped with the display demonstration. To cancel it, see page 8.
- Esta unidad está equipada con demostración en la pantalla. Para cancelarla, consulte la página 8.
- Cet appareil est équipé d'une fonction de démonstration des affichages. Pour l'annuler, référez-vous à la page 8.

For installation and connections, refer to the separate manual.

Para la instalación y las conexiones, refiérase al manual separado.

Pour l'installation et les raccordements, se référer au manuel séparé.

For customer Use:

Enter below the Model No. and Serial No. which are located on the top or bottom of the cabinet. Retain this information for future reference.

Model No. _____

Serial No. _____

INSTRUCTIONS

MANUAL DE INSTRUCCIONES
MANUEL D'INSTRUCTIONS

GET0246-001A

[J]

INFORMATION (For U.S.A.)

This equipment has been tested and found to comply with the limits for a Class B digital device, pursuant to Part 15 of the FCC Rules. These limits are designed to provide reasonable protection against harmful interference in a residential installation. This equipment generates, uses, and can radiate radio frequency energy and, if not installed and used in accordance with the instructions, may cause harmful interference to radio communications. However, there is no guarantee that interference will not occur in a particular installation. If this equipment does cause harmful interference to radio or television reception, which can be determined by turning the equipment off and on, the user is encouraged to try to correct the interference by one or more of the following measures:

- Reorient or relocate the receiving antenna.
- Increase the separation between the equipment and receiver.
- Connect the equipment into an outlet on a circuit different from that to which the receiver is connected.
- Consult the dealer or an experienced radio/TV technician for help.

IMPORTANT FOR LASER PRODUCTS

1. CLASS 1 LASER PRODUCT
2. **CAUTION:** Do not open the top cover. There are no user serviceable parts inside the unit; leave all servicing to qualified service personnel.
3. **CAUTION:** Visible and invisible laser radiation when open and interlock failed or defeated. Avoid direct exposure to beam.

Warning:

If you need to operate the receiver while driving, be sure to look ahead carefully or you may be involved in a traffic accident.

How to reset your receiver

Press and hold both buttons at the same time.

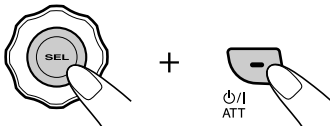

- This will reset the microcomputer. Your preset adjustments will also be erased.
- If a disc is loaded, it will eject. Be careful not to drop the disc.

How to forcibly eject a disc

If a disc cannot be recognized by the receiver or cannot be ejected, ejects the disc as follows.

Press and hold both buttons at the same time.



- If this does not work, try to reset your receiver.
- Be careful not to drop the disc when it ejects.

Thank you for purchasing a JVC product. Please read all instructions carefully before operation, to ensure your complete understanding and to obtain the best possible performance from the unit.

CONTENTS

| | | | |
|---|-----------|---|-----------|
| How to reset your receiver | 2 | Locating a track or a particular portion on a CD | 15 |
| How to forcibly eject a disc | 2 | Selecting CD playback modes | 15 |
| How to use the MODE button | 3 | Prohibiting CD ejection | 16 |
| LOCATION OF THE BUTTONS | 4 | SOUND ADJUSTMENTS | 17 |
| Control panel | 4 | Selecting preset sound modes (C-EQ: custom equalizer) | 17 |
| Remote controller | 5 | Adjusting the sound | 18 |
| Preparing the remote controller | 6 | OTHER MAIN FUNCTIONS | 19 |
| BASIC OPERATIONS | 7 | Selecting the dimmer mode | 19 |
| Turning on the power | 7 | Selecting the amplifier gain control | 19 |
| Canceling the display demonstration | 8 | Detaching the control panel | 20 |
| Setting the clock | 9 | TROUBLESHOOTING | 21 |
| RADIO OPERATIONS | 10 | MAINTENANCE | 22 |
| Listening to the radio | 10 | Handling discs | 22 |
| Storing stations in memory | 12 | SPECIFICATIONS | 23 |
| Tuning in to a preset station | 13 | | |
| CD OPERATIONS | 14 | | |
| Playing a CD | 14 | | |

How to use the MODE button

If you press MODE, the unit goes into functions mode, then the number buttons work as different function buttons.

Ex.: When number button 2 works as MO (monaural) button.

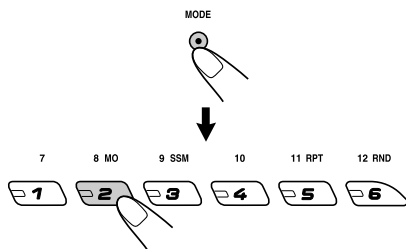

Time countdown indicator

To use these buttons for original functions again after pressing MODE, wait for 5 seconds without pressing any of these buttons until the functions mode is cleared.

- Pressing MODE again also clears the functions mode.

BEFORE USE

*For safety....

- Do not raise the volume level too much, as this will block outside sounds, making driving dangerous.
- Stop the car before performing any complicated operations.

*Temperature inside the car....

If you have parked the car for a long time in hot or cold weather, wait until the temperature in the car becomes normal before operating the unit.



LOCATION OF THE BUTTONS

ENGLISH

Control panel

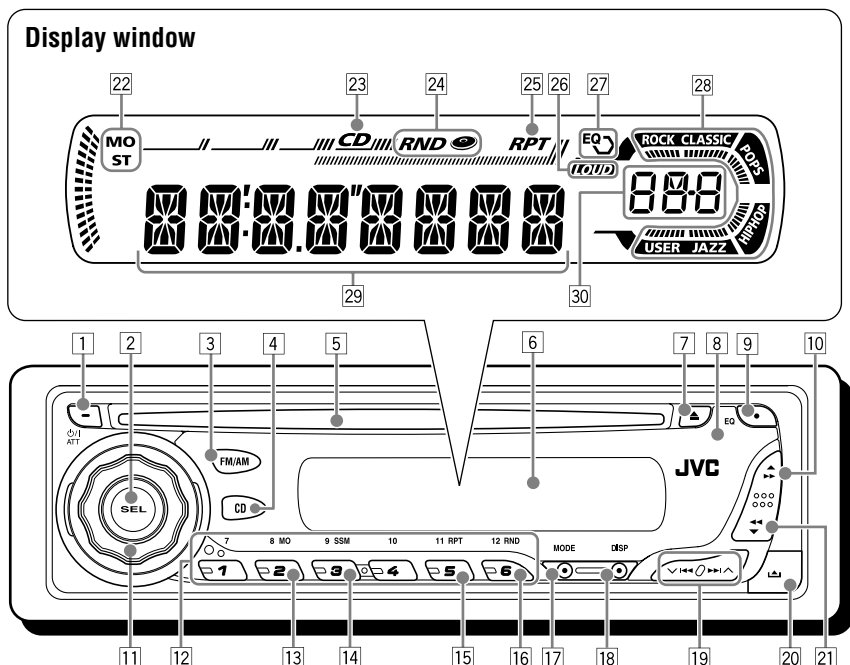

- 1 ϕ /I ATT (standby/on attenuator) button
- 2 SEL (select) button
- 3 FM/AM button
- 4 CD button
- 5 Loading slot
- 6 Display window
- 7 \blacktriangle (eject) button
- 8 Remote sensor
- 9 EQ (equalizer) button
- 10 \blacktriangle (up) button
- 11 $\blacktriangleright\blacktriangleright$ (fast-forward) button
- 12 Control dial
- 13 Number buttons
- 14 MO (monaural) button
- 15 SSM (Strong-station Sequential Memory) button
- 16 RPT (repeat) button
- 17 RND (random) button
- 18 MODE button
- 19 DISP (display) button
- 20 \blacktriangledown (control panel release) button
- 21 \blacktriangledown (down) button
- 22 \blacktriangleleft (reverse) button

Display window

- 22 Tuner reception indicators—MO (monaural), ST (stereo)
- 23 CD indicator
- 24 RND (random disc) indicator
- 25 RPT (repeat) indicator
- 26 LOUD (loudness) indicator
- 27 EQ (equalizer) indicator
- 28 Sound mode (C-EQ: custom equalizer) indicators—ROCK, CLASSIC, POPS, HIP HOP, JAZZ, USER
- 29 Main display
- 30 Source display
- Volume level indicator



Remote controller

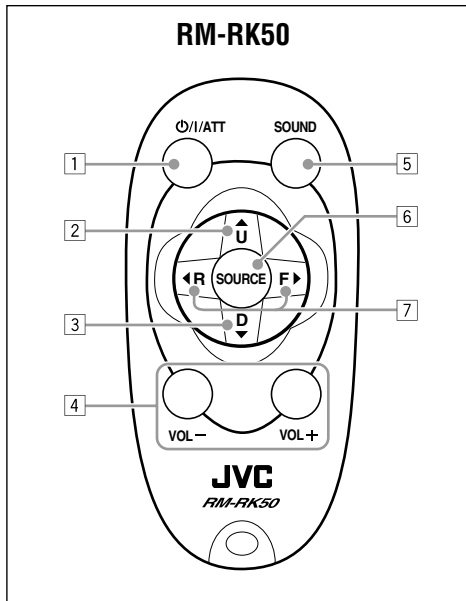

- 1 • Turns on the unit if pressed when the unit is turned off.
 - Turns off the unit if pressed and held until “SEE YOU” appears on the display.
 - Drops the volume level in a moment if pressed briefly.
Press again to resume the volume.
- 2 Selects the band while listening to the radio.
Each time you press the button, the band changes.
- 3 Selects the preset stations while listening to the radio.
Each time you press the button, the preset station number increases, and the selected station is tuned in.

- 4 Functions the same as the control dial on the main unit.

Note: These buttons are not used for adjusting “DEMO”, “CLOCK H”, “CLOCK M”, “DIMMER”, and “AMP GAIN” (see pages 8, 9 and 19).

- 5 Selects the sound mode (C-EQ: custom equalizer).
Each time you press the button, the sound mode (C-EQ) changes.
- 6 Selects the source.
Each time you press the button, the source changes.
- 7 • Searches for stations while listening to the radio.
 - Fast-forwards or reverses the track if pressed and held while listening to a CD.
 - Skips to the beginning of the next track or goes back to the beginning of the current (or previous) tracks if pressed briefly while listening to a CD.



Preparing the remote controller

Before using the remote controller:

- Aim the remote controller directly at the remote sensor on the main unit. Make sure there is no obstacle in between.

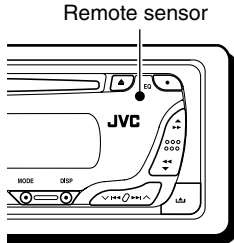

- Do not expose the remote sensor to strong light (direct sunlight or artificial lighting).

Installing the battery

When the controllable range or effectiveness of the remote controller decreases, replace the battery.

1. Remove the battery holder.

- 1) Push out the battery holder in the direction indicated by the arrow using a ball point pen or a similar tool.
- 2) Remove the battery holder.

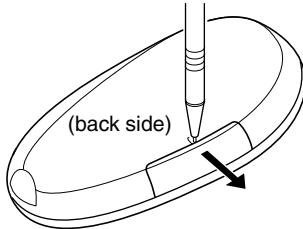

2. Place the battery.

Slide the battery into the holder with the + side facing upwards so that the battery is fixed in the holder.

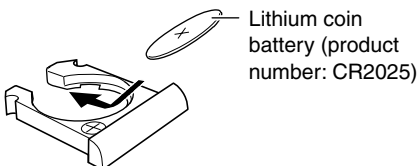

3. Return the battery holder.

Insert again the battery holder by pushing it until you hear a clicking sound.

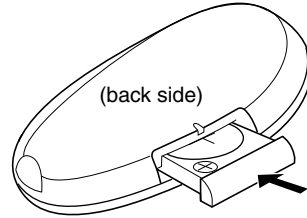

WARNING:

- Store the battery in a place which children cannot reach.
If a child accidentally swallows the battery, immediately consult a doctor.
- Do not recharge, short, disassemble or heat the battery or dispose of in a fire.
Doing any of these things may cause the battery to give off heat, crack or start a fire.
- Do not leave the battery with other metallic materials.
Doing this may cause the battery to give off heat, crack or start a fire.
- When throwing away or saving the battery, wrap in tape and insulate; otherwise, it may cause the battery to give off heat, crack or start a fire.
- Do not poke the battery with tweezers or similar tools.
Doing this may cause the battery to give off heat, crack or start a fire.

CAUTION:

DO NOT leave the remote controller in a place (such as dashboards) exposed to direct sunlight for a long time. Otherwise, it may be damaged.

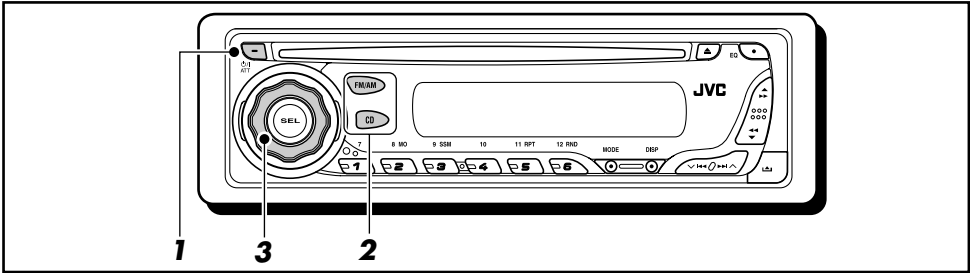

Turning on the power

1 Turn on the power.



Note on One-Touch Operation:

When you select a source in step 2 below, the power automatically comes on. You do not have to press this button to turn on the power.

2 Select the source.

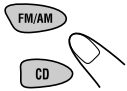

To operate the tuner (FM or AM), see pages 10 – 13.

To play a CD, see pages 14 – 16.

3 Adjust the volume.

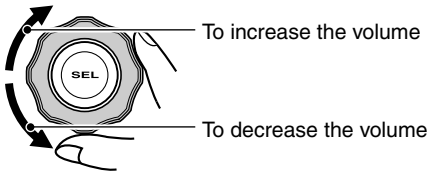

Volume level appears.

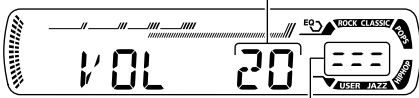

Volume level indicator

4 Adjust the sound as you want. (See pages 17 and 18.)

To drop the volume in a moment

Press ϕ/I ATT briefly while listening to any source. "ATT" starts flashing on the display, and the volume level will drop in a moment.

To resume the previous volume level, press the button briefly again.

- If you turn the control dial, you can also restore the sound.

To turn off the power

Press and hold ϕ/I ATT for more than one second.

"SEE YOU" appears, then the unit turns off.

- **If you turn off the power while listening to a CD,** CD play will start from where playback has been stopped previously, next time you turn on the power.

CAUTION on Volume Setting:

CDs produce very little noise compared with other sources. If the volume level is adjusted for the tuner, for example, the speakers may be damaged by the sudden increase in the output level. Therefore, lower the volume before playing a CD and adjust it as required during playback.

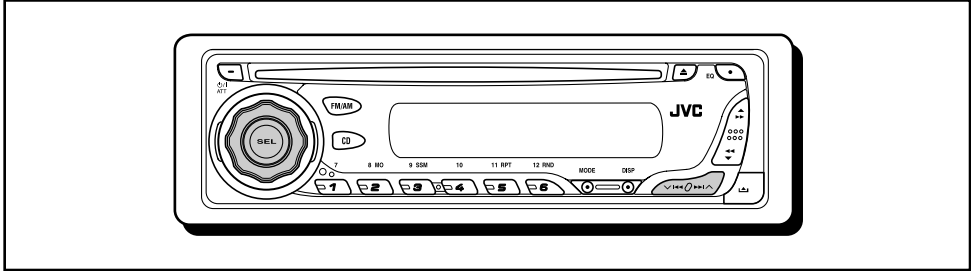

Canceling the display demonstration

When shipped from the factory, display demonstration has been activated, and starts automatically when no operations are done for about 20 seconds.

- It is recommended to cancel the display demonstration before you use the unit for the first time.

To cancel the display demonstration, follow the procedure below:

1 Press and hold SEL (select) for more than 2 seconds.

“DEMO”, “CLOCK H”, “CLOCK M”, “DIMMER”, or “AMP GAIN” appears on the display.



2 Select “DEMO” if not shown on the display.

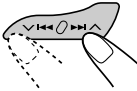

3 Select “DEMO OFF.”

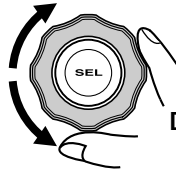

DEMO OFF ↔ DEMO ON

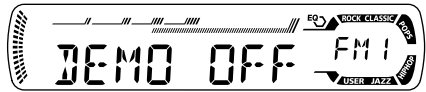

4 Finish the setting.



To activate the display demonstration, repeat the same procedure and select “DEMO ON” in step 3.

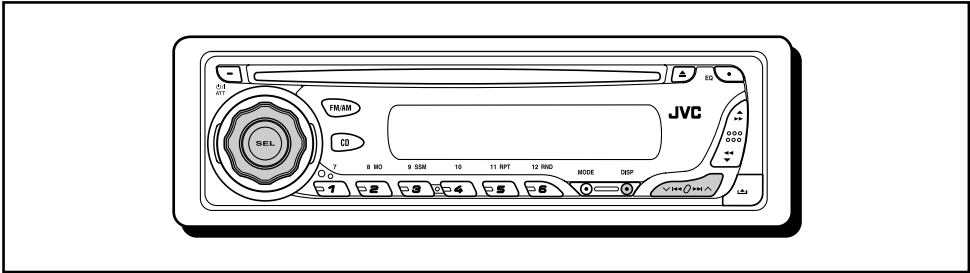

Setting the clock

1 Press and hold SEL (select) for more than 2 seconds.

"DEMO", "CLOCK H", "CLOCK M", "DIMMER", or "AMP GAIN" appears on the display.



2 Set the hour.

- 1 Select "CLOCK H" (hour) if not shown on the display.
- 2 Adjust the hour.

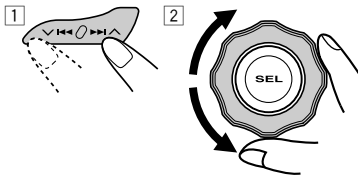

3 Set the minute.

- 1 Select "CLOCK M" (minute).
- 2 Adjust the minute.

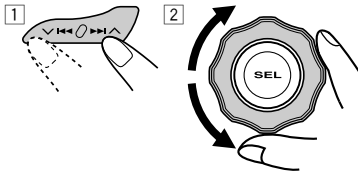

4 Finish the setting.



To check the current clock time or change the display mode



Press DISP (display) repeatedly. Each time you press the button, the display changes as follows:

- During tuner operation:

Frequency ↔ Clock

- During CD operation:

Elapsed playing time ↔ Clock

- During power off:

The power turns on and the clock time is shown for 5 seconds, then the power turns off.



RADIO OPERATIONS

ENGLISH

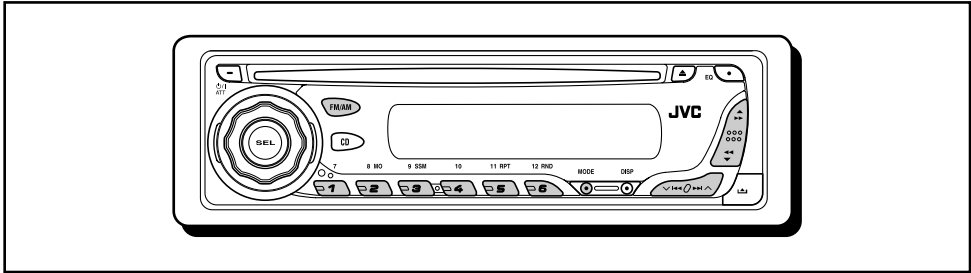

Listening to the radio

You can use either automatic searching or manual searching to tune in to a particular station.

Searching for a station automatically: Auto search

1 Select the band (FM1 – 3, AM).



Each time you press the button, the band changes as follows:

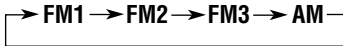

Lights up when receiving an FM stereo broadcast with sufficient signal strength.

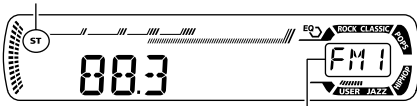

Selected band appears.

Note:

This receiver has three FM bands (FM1, FM2, FM3). You can use any one of them to listen to an FM broadcast.

2 Start searching for a station.



To search for stations of higher frequencies

To search for stations of lower frequencies

When a station is received, searching stops.

To stop searching before a station is received, press the same button you have pressed for searching.

Searching for a station manually: Manual search

1 Select the band (FM1 – 3, AM).



Each time you press the button, the band changes as follows:

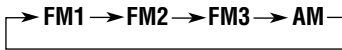

Note:

This receiver has three FM bands (FM1, FM2, FM3). You can use any one of them to listen to an FM broadcast.

2 Press and hold **▶▶** **▲** or **▼** **◀◀** until “M” (manual) starts flashing on the display.

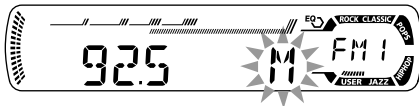
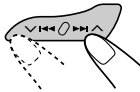

3 Tune in to a station you want while “M” (manual) is still flashing.

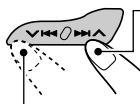

To tune in to stations of higher frequencies

To tune in to stations of lower frequencies

- If you release your finger from the button, the manual mode will automatically turn off after 5 seconds.
- If you hold down the button, the frequency keeps changing (in 200 kHz intervals for FM and 10 kHz for AM) until you release the button.

When an FM stereo broadcast is hard to receive

MODE



- 1 Press MODE to enter the functions mode while listening to an FM stereo broadcast.

8 MO



- 2 Press MO (monaural), while “MODE” is still flashing on the display, so that “MONO” appears on the display. Each time you press the button, monaural mode turns on and off alternately.

MO (monaural) indicator

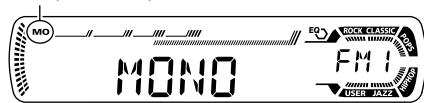

When the MO indicator is lit on the display, the sound you hear becomes monaural but the reception will be improved.



Storing stations in memory

You can use one of the following two methods to store broadcasting stations in memory.

- Automatic preset of FM stations: SSM (Strong-station Sequential Memory)
- Manual preset of both FM and AM stations

FM station automatic preset: SSM

You can preset 6 local FM stations in each FM band (FM1, FM2, and FM3).

1 Select the FM band (FM1 – 3) you want to store FM stations into.



Each time you press the button, the band changes as follows:

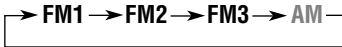

2 Press MODE to enter the functions mode.

MODE



3 Press and hold SSM for about 2 seconds.

SSM



“SSM” flashes, then disappears when automatic preset is over.

Local FM stations with the strongest signals are searched and stored automatically in the band number you have selected (FM1, FM2, or FM3). These stations are preset in the number buttons—No.1 (lowest frequency) to No.6 (highest frequency).

When automatic preset is over, the station stored in number button 1 will be automatically tuned in.

Manual preset

You can preset up to 6 stations in each band (FM1, FM2, FM3, and AM) manually.

Ex.: Storing FM station of 92.5 MHz into the preset number 1 of the FM1 band.

1 Select the band (FM1 – 3, AM) you want to store stations into (in this example, FM1).



Each time you press the button, the band changes as follows:

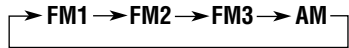

2 Tune in to a station (in this example, of 92.5 MHz).



To tune in to stations of higher frequencies

To tune in to stations of lower frequencies

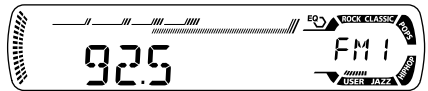

3 Press and hold the number button (in this example, 1) for more than 2 seconds.

1

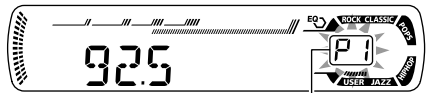

Preset number flashes for a while.

4 Repeat the above procedure to store other stations into other preset numbers.

Notes:

- A previously preset station is erased when a new station is stored in the same preset number.
- Preset stations are erased when the power supply to the memory circuit is interrupted (for example, during battery replacement). If this occurs, preset the stations again.

Tuning in to a preset station

You can easily tune in to a preset station. Remember that you must store stations first. If you have not stored them yet, see “Storing stations in memory” on pages 12 and 13.

1 Select the band (FM1 – 3, AM).



Each time you press the button, the band changes as follows:

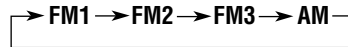

2 Select the number (1 – 6) for the preset station you want.

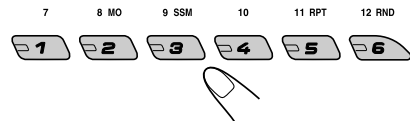

Note:

You can also use the ▲ (up) or ▼ (down) button on the unit to select the next or previous preset stations. Each time you press the ▲ (up) or ▼ (down) button, the next or previous preset station is tuned in.



CD OPERATIONS

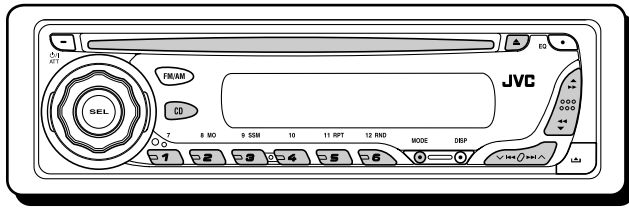

Playing a CD

Insert a CD into the loading slot.

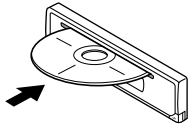

The unit turns on, draws the CD and starts playback automatically.

Note on One-Touch Operation:

When a CD is already in the loading slot, pressing CD turns on the unit and starts playback automatically.

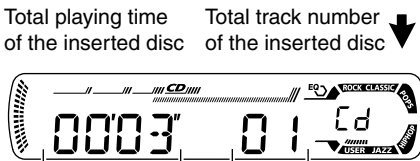
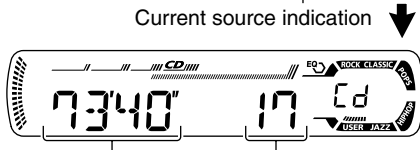
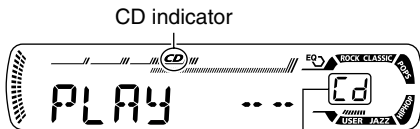

All tracks will be played repeatedly until you stop playback.

Note:

When a CD is inserted upside down, "EJECT" appears on the display and the CD automatically ejects.

To stop play and eject the CD

Press ▲.

CD play stops and the CD automatically ejects from the loading slot. The source changes to the tuner (you will hear the last received station.)

- If you change the source, CD play also stops (without ejecting the CD).

Next time you select "CD" as the source, CD play starts from where playback has been stopped previously.

Notes:

- If the ejected CD is not removed for about 15 seconds, the CD is automatically inserted again into the loading slot to protect it from dust. (CD play will not start this time.)
- You can eject the CD even when the unit is turned off.

About mistracking:

Mistracking may result from driving on extremely rough roads. This does not damage the unit and the CD, but will be annoying.

We recommend that you stop CD play while driving on such rough roads.



Locating a track or a particular portion on a CD

To fast-forward or reverse the track

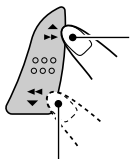

Press and hold ►►, while playing a CD, to fast-forward the track.

Press and hold ◀◀, while playing a CD, to reverse the track.

To go to the next or previous tracks

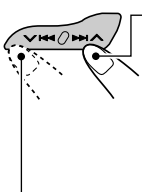

Press ►►|▲ briefly, while playing a CD, to go ahead to the beginning of the next track. Each time you press the button consecutively, the beginning of the next tracks is located and played back.

Press ▼◀◀ briefly, while playing a CD, to go back to the beginning of the current track. Each time you press the button consecutively, the beginning of the previous tracks is located and played back.

To go to a particular track directly

Press the number button corresponding to the track number to start its playback.

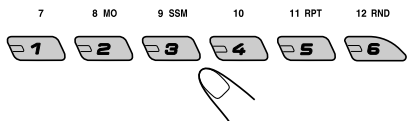

- To select a track number from 1 – 6:
Press 1 (7) – 6 (12) briefly.
- To select a track number from 7 – 12:
Press and hold 1 (7) – 6 (12) for more than one second.

Selecting CD playback modes

To play back tracks at random (Disc Random Play)

You can play back all tracks on the CD at random.



- 1 Press MODE to enter the functions mode while playing a CD.

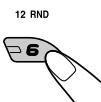

- 2 Press RND (random), while “MODE” is still flashing on the display, so that “DISC RND” appears on the display. Each time you press the button, disc random play mode turns on and off alternately.

RND (random disc) indicator



When disc random play is turned on, the RND indicator lights up on the display. A track randomly selected starts playing.



To play back tracks repeatedly (Track Repeat Play)

You can play back the current track repeatedly.

MODE



- 1 Press MODE to enter the functions mode while playing a CD.

11 RPT



- 2 Press RPT (repeat), while "MODE" is still flashing on the display, so that "TRK RPT" appears on the display. Each time you press the button, track repeat play mode turns on and off alternately.

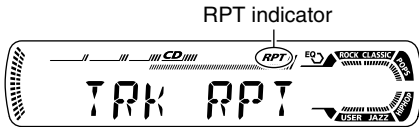

When track repeat play is turned on, the RPT indicator lights up on the display. The current track starts playing repeatedly.

Prohibiting CD ejection

You can prohibit CD ejection and can lock a CD in the loading slot.

While pressing CD, press and hold ▲ for more than 2 seconds.



"NO EJECT" flashes on the display for about 5 seconds, and the CD is locked and cannot be ejected.



To cancel the prohibition and unlock the CD

While pressing CD, press and hold ▲ again for more than 2 seconds.

"EJECT" appears on the display, and the CD ejects from the loading slot.



Selecting preset sound modes (C-EQ: custom equalizer)

You can select a preset sound mode (C-EQ: custom equalizer) suitable to the music genre.

Select the sound mode you want.



Each time you press the button, the sound modes change as follows:

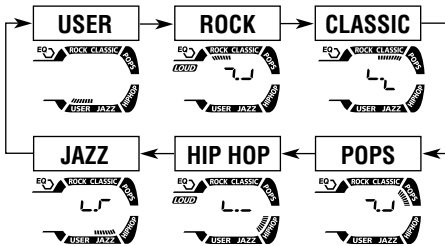

Indication pattern changes for each sound mode except for "USER."



Ex.: When you select "ROCK"

| Indication | For: | Preset values | | |
|------------|---------------------|---------------|-----|------|
| | | BAS | TRE | LOUD |
| USER | (Flat sound) | 00 | 00 | OFF |
| ROCK | Rock or disco music | +03 | +01 | ON |
| CLASSIC | Classical music | +01 | -02 | OFF |
| POPS | Light music | +04 | +01 | OFF |
| HIP HOP | Funk or rap music | +02 | 00 | ON |
| JAZZ | Jazz music | +02 | +03 | OFF |

Note:

You can adjust each sound mode to your preference. Once you make an adjustment, it is automatically stored for the currently selected sound mode. See "Adjusting the sound" on page 18.



Adjusting the sound

You can adjust the sound characteristics to your preference.

1 Select the item you want to adjust.



Each time you press the button, the adjustable items change as follows:

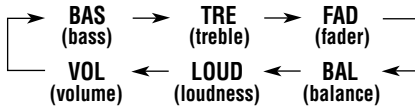

| Indication | To do: | Range |
|--------------------|--|---|
| BAS* ¹ | Adjust the bass. | -06 (min.) +06 (max.) |
| TRE* ¹ | Adjust the treble. | -06 (min.) +06 (max.) |
| FAD* ² | Adjust the front and rear speaker balance. | R06 (Rear only) F06 (Front only) |
| BAL | Adjust the left and right speaker balance. | L06 (Left only) R06 (Right only) |
| LOUD* ¹ | Boost low and high frequencies to produce a well-balanced sound at low volume level. | LOUD ON LOUD OFF |
| VOL* ³ | Adjust the volume. | 00 (min.) 30 or 50 (max.)* ⁴ |

- *1 When you adjust the bass, treble, or loudness, the adjustment you have made is stored for the currently selected sound mode (C-EQ) including "USER".
- *2 If you are using a two-speaker system, set the fader level to "00".
- *3 Normally the control dial works as the volume control. So you do not have to select "VOL" to adjust the volume level.
- *4 Depending on the amplifier gain control setting. (See page 19 for details).

2 Adjust the setting.

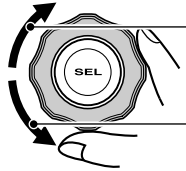

To increase the level or turn on the loudness

To decrease the level or turn off the loudness

Indication pattern changes as you adjust the bass or treble.

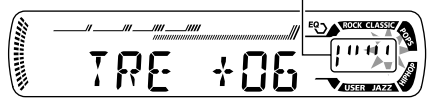

Ex. 1: When you adjust "TRE" (treble)

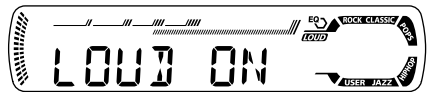

Ex. 2: When you turn on the loudness

3 Repeat steps 1 and 2 to adjust the other items.

To reset each sound mode to the factory settings, repeat the same procedure and reassign the preset values listed in the table on page 17.

OTHER MAIN FUNCTIONS



Selecting the dimmer mode

You can dim the display at night (according to your preference).
When shipped from the factory, dimmer is deactivated.

1 Press and hold SEL (select) for more than 2 seconds.

“DEMO”, “CLOCK H”, “CLOCK M”, “DIMMER”, or “AMP GAIN” appears on the display.



2 Select “DIMMER” if not shown on the display.

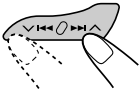

3 Select the desired mode—“OFF” or “ON.”

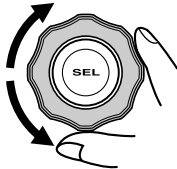

- OFF: Cancels the dimmer.
- ON: Activates the dimmer.

4 Finish the setting.



Selecting the amplifier gain control

You can change the maximum volume level of this unit. When the maximum power of the speakers is less than 50 W, select “LOW PWR” to prevent them from being damaged.
When shipped from the factory, “HIGH PWR” is selected.

1 Press and hold SEL (select) for more than 2 seconds.

“DEMO”, “CLOCK H”, “CLOCK M”, “DIMMER”, or “AMP GAIN” appears on the display.



2 Select “AMP GAIN” if not shown on the display.

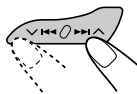

3 Select the desired mode—“HIGH PWR” or “LOW PWR”.



- LOW PWR: You can adjust the volume level from “VOL 00” to “VOL 30”.
- HIGH PWR: You can adjust the volume level from “VOL 00” to “VOL 50”.

4 Finish the setting.



Note:

If you change the setting from “HIGH PWR” to “LOW PWR” while listening at a volume level more than 30, the unit automatically changes the volume level to “VOL 30”.



Detaching the control panel

You can detach the control panel when leaving the car.

When detaching or attaching the control panel, be careful not to damage the connectors on the back of the control panel and on the panel holder.

Detaching the control panel

Before detaching the control panel, be sure to turn off the power.

- 1 Unlock the control panel.

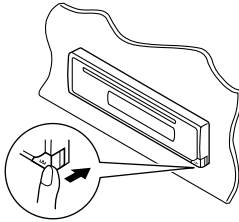

- 2 Lift and pull the control panel out of the unit.

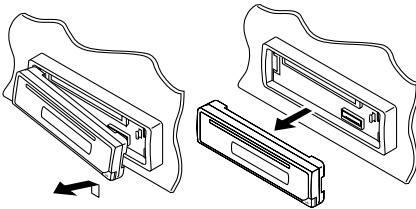

- 3 Put the detached control panel into the provided case.

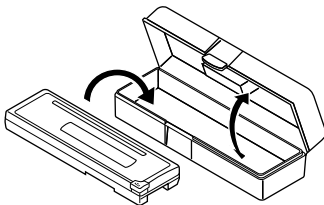

Attaching the control panel

- 1 Insert the left side of the control panel into the groove on the panel holder.

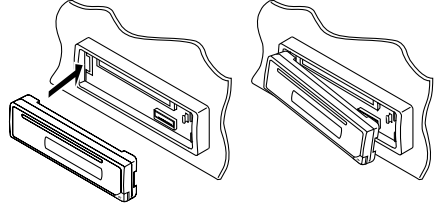

- 2 Press the right side of the control panel to fix it to the panel holder.

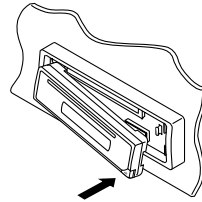

Note on cleaning the connectors:

If you frequently detach the control panel, the connectors will deteriorate.

To minimize this possibility, periodically wipe the connectors with a cotton swab or cloth moistened with alcohol, being careful not to damage the connectors.

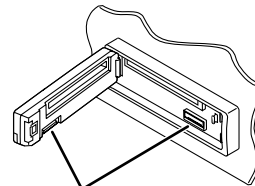

Connectors

TROUBLESHOOTING

What appears to be trouble is not always serious. Check the following points before calling a service center.

| | Symptoms | Causes | Remedies |
|-------------|--|--|---|
| General | <ul style="list-style-type: none"> • Sound cannot be heard from the speakers. | The volume level is set to the minimum level. | Adjust it to the optimum level. |
| | | Connections are incorrect. | Check the cords and connections. |
| | <ul style="list-style-type: none"> • This unit does not work at all. | The built-in microcomputer may have functioned incorrectly due to noise, etc. | While holding SEL (select), press ϕ /I ATT (standby/on attenuator) for more than 2 seconds to reset the unit. (Your preset adjustments will also be erased.) (See page 2.) |
| FM/AM | <ul style="list-style-type: none"> • SSM (Strong-station Sequential Memory) automatic preset does not work. | Signals are too weak. | Store stations manually. |
| | <ul style="list-style-type: none"> • Static noise while listening to the radio. | The antenna is not connected firmly. | Connect the antenna firmly. |
| CD Playback | <ul style="list-style-type: none"> • CD automatically ejects. | CD is inserted upside down. | Insert the CD correctly. |
| | <ul style="list-style-type: none"> • CD-R/CD-RW cannot be played back. • Tracks on the CD-R/CD-RW cannot be skipped. | CD-R/CD-RW is not finalized. | <ul style="list-style-type: none"> • Insert a finalized CD-R/CD-RW. • Finalize the CD-R/CD-RW with the component which you used for recording. |
| | | <ul style="list-style-type: none"> • CD can be neither played back nor ejected. | CD is locked. |
| | <ul style="list-style-type: none"> • CD sound is sometimes interrupted. | The CD player may have functioned incorrectly. | While holding ϕ /I ATT (standby/on attenuator), press \blacktriangle (eject) for more than 2 seconds. Be careful not to drop the CD when it is ejected. |
| | | You are driving on rough roads. | Stop playback while driving on rough roads. |
| | | CD is scratched. | Change the CD. |
| | <ul style="list-style-type: none"> • "NO DISC" appears on the display. | Connections are incorrect. | Check the cords and connections. |
| | | No CD in the loading slot. | Insert a CD into the loading slot. |
| | | CD is inserted incorrectly. | Insert the CD correctly. |



MAINTENANCE

ENGLISH

Handling discs

This unit has been designed to reproduce CDs, CD-Rs (Recordable), and CD-RWs (Rewritable).

- **This unit is not compatible with MP3 discs.**

How to handle discs

When removing a disc from its case, press down the center holder of the case and lift the disc out, holding it by the edges.

- Always hold the disc by the edges. Do not touch its recording surface.

When storing a disc into its case, gently insert the disc around the center holder (with the printed surface facing up).

- Make sure to store discs into the cases after use.

Center holder



To keep discs clean

A dirty disc may not be played correctly. If a disc does become dirty, wipe it with a soft cloth in a straight line from center to edge.



To play new discs

New discs may have some rough spots around the inner and outer edges. If such a disc is used, this unit may reject the disc.



To remove these rough spots, rub the edges with a pencil or ball-point pen, etc.

Moisture condensation

Moisture may condense on the lens inside the CD player in the following cases:

- After starting the heater in the car.
- If it becomes very humid inside the car.

Should this occur, the CD player may malfunction. In this case, eject the disc and leave the unit turned on for a few hours until the moisture evaporates.

When playing a CD-R or CD-RW

Before playing back CD-Rs or CD-RWs, read their instructions or cautions carefully.

- Use only "finalized" CD-Rs or CD-RWs.
- Some CD-Rs or CD-RWs may not be played back on this unit because of their disc characteristics, and for the following reasons:
 - Discs are dirty or scratched.
 - Moisture condensation on the lens inside the unit.
 - The pickup lens inside the unit is dirty.
- CD-RWs may require a longer readout time since the reflectance of CD-RWs is lower than that of regular CDs.
- CD-Rs or CD-RWs are susceptible to high temperatures or high humidity, so do not leave them inside your car.
- Do not use following CD-Rs or CD-RWs:
 - Discs with stickers, labels, or protective seal stuck to the surface.
 - Discs on which labels can be directly printed by an ink jet printer.

Using these discs under high temperatures or high humidity may cause malfunctions or damage to discs. For example,

- Stickers or labels may shrink and warp a disc.
- Stickers or labels may be peeled off so discs cannot be ejected.
- Print on discs may get sticky.

Read instructions or cautions about labels and printable discs carefully.

CAUTIONS:

- Do not insert 8 cm (3 3/16") discs (single CDs) into the loading slot. (Such discs cannot be ejected.)
- Do not insert any disc of unusual shape—like a heart or flower; otherwise, it will cause a malfunction.
- Do not expose discs to direct sunlight or any heat source or place them in a place subject to high temperature and humidity. Do not leave them in a car.
- Do not use any solvent (for example, conventional record cleaner, spray, thinner, benzene, etc.) to clean discs.

Warped disc



Sticker



Sticker residue

Disc



Stick-on label

SPECIFICATIONS

AUDIO AMPLIFIER SECTION

Power Output:
18 W RMS \times 4 Channels at 4 Ω
and \leq 1 % THD + N
Signal to Noise Ratio:
80 dBA (reference: 1 W into 4 Ω)



Load Impedance: 4 Ω (4 Ω to 8 Ω allowance)
Tone Control Range:
Bass: \pm 10 dB at 100 Hz
Treble: \pm 10 dB at 10 kHz
Frequency Response: 40 Hz to 20 000 Hz
Line-Out Level/Impedance:
2.5 V/20 k Ω load (full scale)
Output Impedance: 1 k Ω

TUNER SECTION

Frequency Range:
FM: 87.5 MHz to 107.9 MHz
AM: 530 kHz to 1 710 kHz

[FM Tuner]

Usable Sensitivity:
11.3 dBf (1.0 μ V/75 Ω)
50 dB Quietening Sensitivity:
16.3 dBf (1.8 μ V/75 Ω)
Alternate Channel Selectivity (400 kHz):
65 dB
Frequency Response: 40 Hz to 15 000 Hz
Stereo Separation: 35 dB
Capture Ratio: 1.5 dB

[AM Tuner]

Sensitivity: 20 μ V
Selectivity: 35 dB

CD PLAYER SECTION

Type: Compact disc player
Signal Detection System: Non-contact optical pickup (semiconductor laser)
Number of channels: 2 channels (stereo)
Frequency Response: 5 Hz to 20 000 Hz
Dynamic Range: 96 dB
Signal-to-Noise Ratio: 98 dB
Wow and Flutter: Less than measurable limit

GENERAL

Power Requirement:
Operating Voltage:
DC 14.4 V (11 V to 16 V allowance)
Grounding System: Negative ground
Allowable Operating Temperature:
0°C to +40°C (32°F to 104°F)
Dimensions (W \times H \times D):
Installation Size (approx.):
182 mm \times 52 mm \times 150 mm
(7-3/16" \times 2-1/16" \times 5-15/16")
Panel Size (approx.):
188 mm \times 58 mm \times 11 mm
(7-7/16" \times 2-5/16" \times 7/16")
Mass (approx.):
1.3 kg (2.9 lbs) (excluding accessories)

Design and specifications are subject to change without notice.

If a kit is necessary for your car, consult your telephone directory for the nearest car audio speciality shop.



**Having TROUBLE with operation?
Please reset your unit**

**Refer to page of How to Reset
Still having trouble??**

USA ONLY

Call 1-800-252-5722

<http://www.jvc.com>

We can help you!

JVC



EN, SP, FR
© 2004 Victor Company of Japan, Limited

0904DTSINTJEIN

JVC KD-AR260/KD-G210

Installation/Connection Manual

Manual de instalación/conexión

Manuel d'installation/raccordement

GET0246-002A
[J]

0904DTSINTJEIN
EN, SP, FR

ENGLISH

This unit is designed to operate on **12 V DC, NEGATIVE ground electrical systems**. If your vehicle does not have this system, a voltage inverter is required, which can be purchased at JVC car audio dealers.

ESPAÑOL

Esta unidad está diseñada para funcionar con **12 V de CC, con sistemas eléctricos de masa NEGATIVA**. Si su vehículo no posee este sistema, será necesario un inversor de tensión, que puede ser adquirido en los concesionarios de JVC de equipos de audio para automóviles.

FRANÇAIS

Cet appareil est conçu pour fonctionner sur des sources de courant continu de **12 V à masse NEGATIVE**. Si votre véhicule n'offre pas ce type d'alimentation, il vous faut un convertisseur de tension, que vous pouvez acheter chez un revendeur d'autoradios JVC.

Parts list for installation and connection

The following parts are provided for this unit.
After checking them, please set them correctly.

Lista de piezas para instalación y conexión

Con esta unidad se suministran las siguientes piezas.
Después de inspeccionarlas, colóquelas correctamente.

Liste des pièces pour l'installation et raccordement

Les pièces suivantes sont fournies avec cet appareil.
Après vérification, veuillez les placer correctement.

A / B
Hard case/Control panel
Estuche duro/Panel de control
Etui de transport/Panneau de commande

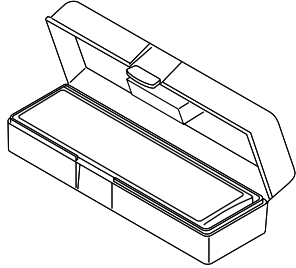

C
Sleeve
Cubierta
Manchon

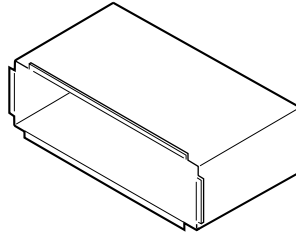

D
Trim plate
Placa de guarnición
Plaque d'assemblage

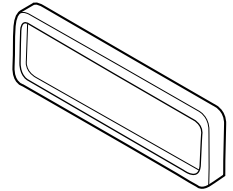

E
Power cord
Cordón de alimentación
Cordon d'alimentation

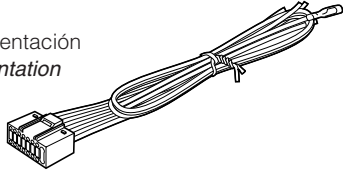

F
Washer (ø5)
Arandela (ø5)
Rondelle (ø5)



G
Lock nut (M5)
Tuerca de seguridad (M5)
Ecrou d'arrêt (M5)



H
Mounting bolt (M5 x 20 mm)
Perno de montaje (M5 x 20 mm)
Boulon de montage (M5 x 20 mm)

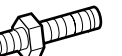

I
Rubber cushion
Cojín de goma
Amortisseur en caoutchouc



J
Handles
Manijas
Poignées

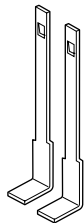

K
Remote controller
Mando a distancia
Télécommande

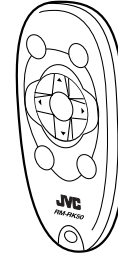

L
Battery
Pila
Pile



CR2025

INSTALLATION (IN-DASH MOUNTING)

The following illustration shows a typical installation. If you have any questions or require information regarding installation kits, consult your JVC car audio dealer or a company supplying kits.

- If you are not sure how to install this unit correctly, have it installed by a qualified technician.

INSTALACION (MONTAJE EN EL TABLERO DE INSTRUMENTOS)

La siguiente ilustración muestra una instalación típica. Si tiene alguna pregunta o necesita información acerca de las herramientas para instalación, consulte con su concesionario de JVC de equipos de audio para automóviles o a una compañía que suministra tales herramientas.

- Si usted no está seguro de cómo instalar correctamente la unidad, hágala instalar por un técnico cualificado.

INSTALLATION (MONTAGE DANS LE TABLEAU DE BORD)

L'illustration suivante est un exemple d'installation typique. Si vous avez des questions ou avez besoin d'information sur des kits d'installation, consultez votre revendeur d'autoradios JVC ou une compagnie d'approvisionnement.

- Si l'on n'est pas sûr de pouvoir installer correctement cet appareil, le faire installer par un technicien qualifié.

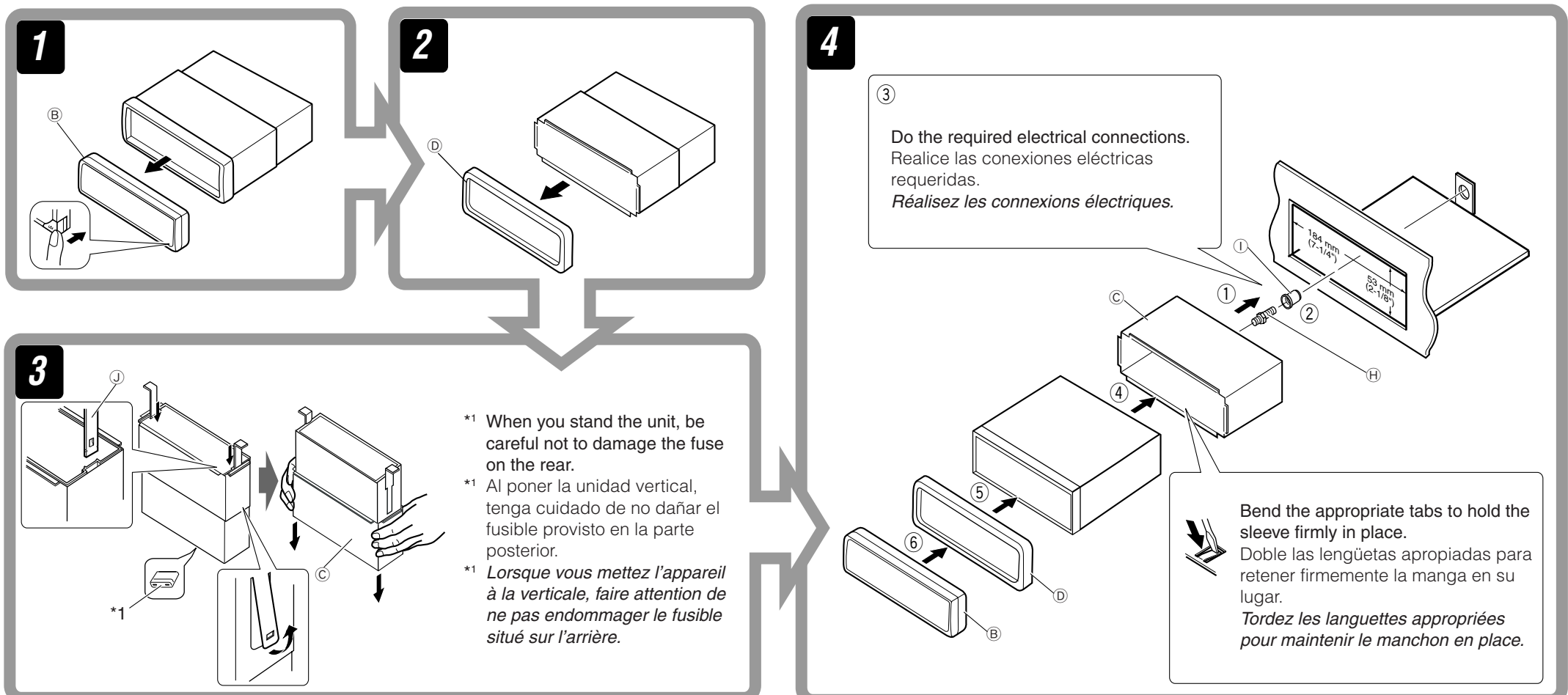

Removing the unit

Before removing the unit, release the rear section.

Extracción de la unidad

Antes de extraer la unidad, libere la sección trasera.

Retrait de l'appareil

Avant de retirer l'appareil, libérez la section arrière.

1

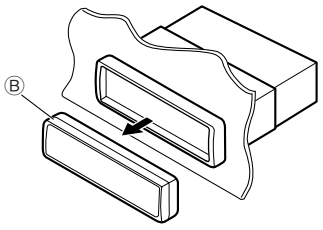

2

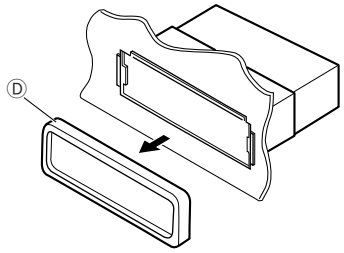

3

Insert the two handles, then pull them as illustrated so that the unit can be removed.
Inserte las dos manijas y, a continuación, extráigalas de la manera indicada en la ilustración para poder desmontar la unidad.
Insérez les deux poignées, puis tirez de la façon illustrée de façon à retirer l'appareil.

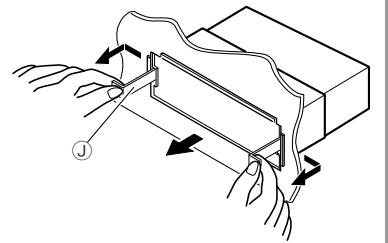

When using the optional stay / Cuando emplea un soporte opcional / Lors de l'utilisation du hauban en option

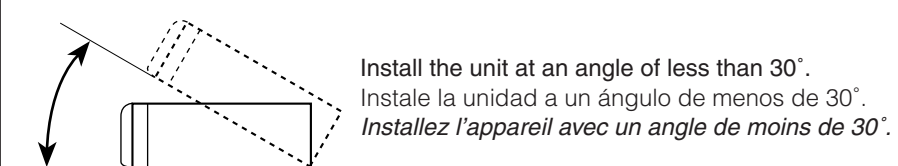
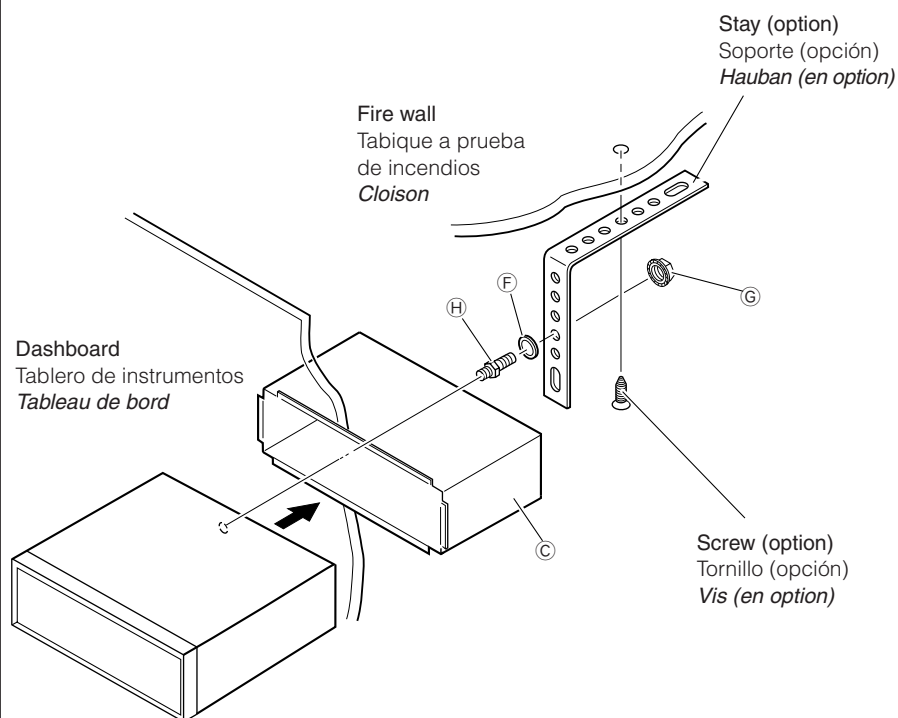

When installing the unit without using the sleeve / Instalación de la unidad sin utilizar la manga / Lors de l'installation de l'appareil sans utiliser de manchon

In a Toyota for example, first remove the car radio and install the unit in its place.
En un Toyota por ejemplo, primero retire la radio del automóvil y luego instale la unidad en su lugar.
Par exemple dans une Toyota, retirer d'abord l'autoradio et installer l'appareil à la place.

Flat type screws—M5 x 8 mm (M5 x 3/8")*
Tornillos tipo plano—M5 x 8 mm (M5 x 3/8 pulgada)*
Vis à tête plate—M5 x 8 mm (M5 x 3/8 pouces)*

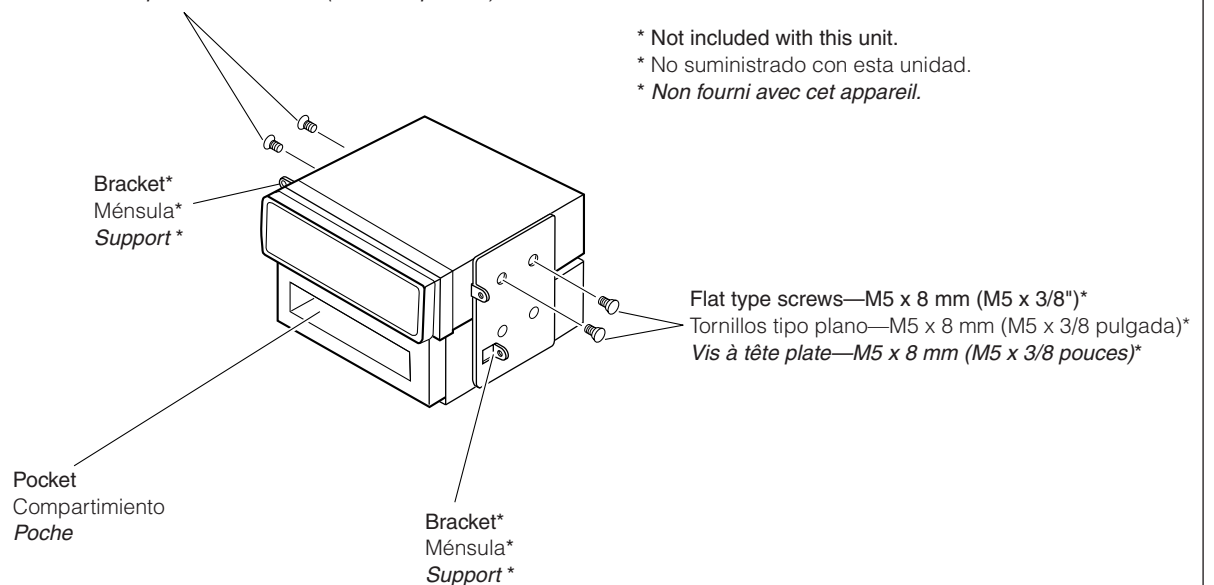

* Not included with this unit.
* No suministrado con esta unidad.
* Non fourni avec cet appareil.

Note : When installing the unit on the mounting bracket, make sure to use the 8 mm (3/8")-long screws. If longer screws are used, they could damage the unit.
Nota : Cuando instala la unidad en la ménsula de montaje, asegúrese de utilizar los tornillos de 8 mm (3/8 pulgada) de longitud. Si se utilizan tornillos más largos, éstos pueden dañar la unidad.
Remarque : Lors de l'installation de l'appareil sur le support de montage, s'assurer d'utiliser des vis d'une longueur de 8 mm (3/8 pouces). Si des vis plus longues sont utilisées, elles peuvent endommager l'appareil.

TROUBLESHOOTING

- **The fuse blows.**
 - * Are the red and black leads connected correctly?
- **Power cannot be turned on.**
 - * Is the yellow lead connected?
- **No sound from the speakers.**
 - * Is the speaker output lead short-circuited?
- **Sound is distorted.**
 - * Is the speaker output lead grounded?
 - * Are the “-” terminals of L and R speakers grounded in common?
- **Noise interfere with sounds.**
 - * Is the rear ground terminal connected to the car's chassis using shorter and thicker cords?
- **Unit becomes hot.**
 - * Is the speaker output lead grounded?
 - * Are the “-” terminals of L and R speakers grounded in common?
- **This receiver does not work at all.**
 - * Have you reset your receiver?

LOCALIZACION DE AVERIAS

- **El fusible se quema.**
 - * ¿Están los conductores rojo y negro correctamente conectados?
- **No es posible conectar la alimentación.**
 - * ¿Está el cable amarillo conectado?
- **No sale sonido de los altavoces.**
 - * ¿Está el cable de salida del altavoz cortocircuitado?
- **El sonido presenta distorsión.**
 - * ¿Está el cable de salida del altavoz conectado a masa?
 - * ¿Están los terminales “-” de los altavoces L y R conectados a una masa común?
- **Perturbación de ruido.**
 - * ¿El terminal de tierra trasero está conectado al chasis del automóvil utilizando los cordones más corto y más grueso?
- **La unidad se calienta.**
 - * ¿Está el cable de salida del altavoz conectado a masa?
 - * ¿Están los terminales “-” de los altavoces L y R conectados a una masa común?
- **Este receptor no funciona en absoluto.**
 - * ¿Reinicializó el receptor?

EN CAS DE DIFFICULTES

- **Le fusible saute.**
 - * Les fils rouge et noir sont-ils raccordés correctement?
- **L'appareil ne peut pas être mise sous tension.**
 - * Le fil jaune est-elle raccordée?
- **Pas de son des enceintes.**
 - * Le fil de sortie d'enceinte est-il court-circuité?
- **Le son est déformé.**
 - * Le fil de sortie d'enceinte est-il à la masse?
 - * Les bornes “-” des enceintes gauche et droit sont-elles mises ensemble à la masse?
- **Interférence avec les sons.**
 - * La prise arrière de mise à la terre est-elle connectée au châssis de la voiture avec un cordon court et épais?
- **L'appareil devient chaud.**
 - * Le fil de sortie d'enceinte est-il à la masse?
 - * Les bornes “-” des enceintes gauche et droit sont-elles mises ensemble à la masse?
- **Cet appareil ne fonctionne pas du tout.**
 - * Avez-vous réinitialisé votre appareil?

ELECTRICAL CONNECTIONS

To prevent short circuits, we recommend that you disconnect the battery's negative terminal and make all electrical connections before installing the unit.

- **Be sure to ground this unit to the car's chassis again after installation.**

Notes:

- Replace the fuse with one of the specified rating. If the fuse blows frequently, consult your JVC car audio dealer.
- It is recommended to connect to the speakers with maximum power of more than 50 W (both at the rear and at the front, with an impedance of 4 Ω to 8 Ω). If the maximum power is less than 50 W, change "AMP GAIN" setting to prevent the speakers from being damaged (see page 19 of the INSTRUCTIONS).
- To prevent short-circuit, cover the terminals of the UNUSED leads with insulating tape.
- The heat sink becomes very hot after use. Be careful not to touch it when removing this unit.

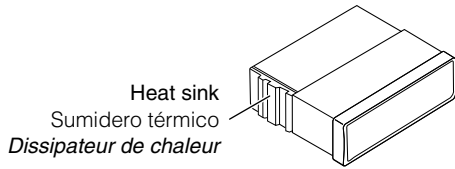

CONEXIONES ELECTRICAS

Para evitar cortocircuitos, recomendamos que desconecte el terminal negativo de la batería y que efectúe todas las conexiones eléctricas antes de instalar la unidad.

- **Asegúrese de volver a conectar a masa esta unidad al chasis del automóvil después de la instalación.**

Notas:

- Reemplace el fusible por uno con la corriente especificada. Si el fusible se quemase frecuentemente consulte con su concesionario de JVC de equipos de audio para automóviles.
- Se recomienda conectar los altavoces con una potencia máxima de más de 50 W (tanto atrás como adelante, con una impedancia de 4 Ω a 8 Ω). Si la potencia máxima es de menos de 50 W, cambie "AMP GAIN" para evitar daños en los altavoces (consulte la página 19 del MANUAL DE INSTRUCCIONES).
- Para evitar cortocircuitos, cubra los cables NO UTILIZADOS con cinta aislante.
- El sumidero térmico estará muy caliente después del uso. Asegúrese de no tocarlo al desmontar esta unidad.

RACCORDEMENTS ELECTRIQUES

Pour éviter tout court-circuit, nous vous recommandons de débrancher la borne négative de la batterie et d'effectuer tous les raccordements électriques avant d'installer l'appareil.

- **Assurez-vous de raccorder de nouveau la mise à la masse de cet appareil au châssis de la voiture après l'installation.**

Remarques:

- Remplacer le fusible par un de la valeur précisée. Si le fusible saute souvent, consulter votre revendeur d'autoradios JVC.
- Il est recommandé de connecter des enceintes avec une puissance de plus de 50 W (les enceintes arrière et les enceintes avant, avec une impédance comprise entre 4 Ω et 8 Ω). Si la puissance maximum est inférieure à 50 W, changez "AMP GAIN" pour éviter d'endommager vos enceintes (voir page 19 du MANUEL D'INSTRUCTIONS).
- Pour éviter les court-circuits, couvrir les bornes des fils qui ne sont PAS UTILISÉS avec de la bande isolante.
- Le dissipateur de chaleur devient très chaud après usage. Faire attention de ne pas le toucher en retirant cet appareil.

A Typical Connections / Conexiones típicas / Raccordements typiques

Before connecting: Check the wiring in the vehicle carefully. Incorrect connection may cause serious damage to this unit. The leads of the power cord and those of the connector from the car body may be different in color.

- 1 Connect the colored leads of the power cord in the order specified in the illustration below.
- 2 Connect the antenna cord.
- 3 Finally connect the wiring harness to the unit.

Antes de la conexión: Verifique atentamente el conexionado del vehículo. Una conexión incorrecta podría producir daños graves en la unidad.

Los cordones del cable de alimentación y los del conector procedentes de la carrocería del automóvil podrían ser de diferentes en color.

- 1 Conecte los conductores de color del cable de alimentación en el orden especificado en la ilustración de abajo.
- 2 Conecte el cable de antena.
- 3 Por último, conecte el cable de alimentación a la unidad.

Avant de commencer la connexion: Vérifiez attentivement le câblage du véhicule. Une connexion incorrecte peut endommager sérieusement l'appareil.

Le fil du cordon d'alimentation et ceux des connecteurs du châssis de la voiture peuvent être différents en couleur.

- 1 Connectez les fils colorés du cordon d'alimentation dans l'ordre spécifié sur l'illustration ci-dessous.
- 2 Connectez le cordon d'antenne.
- 3 Finalement, connectez le faisceau de fils à l'appareil.

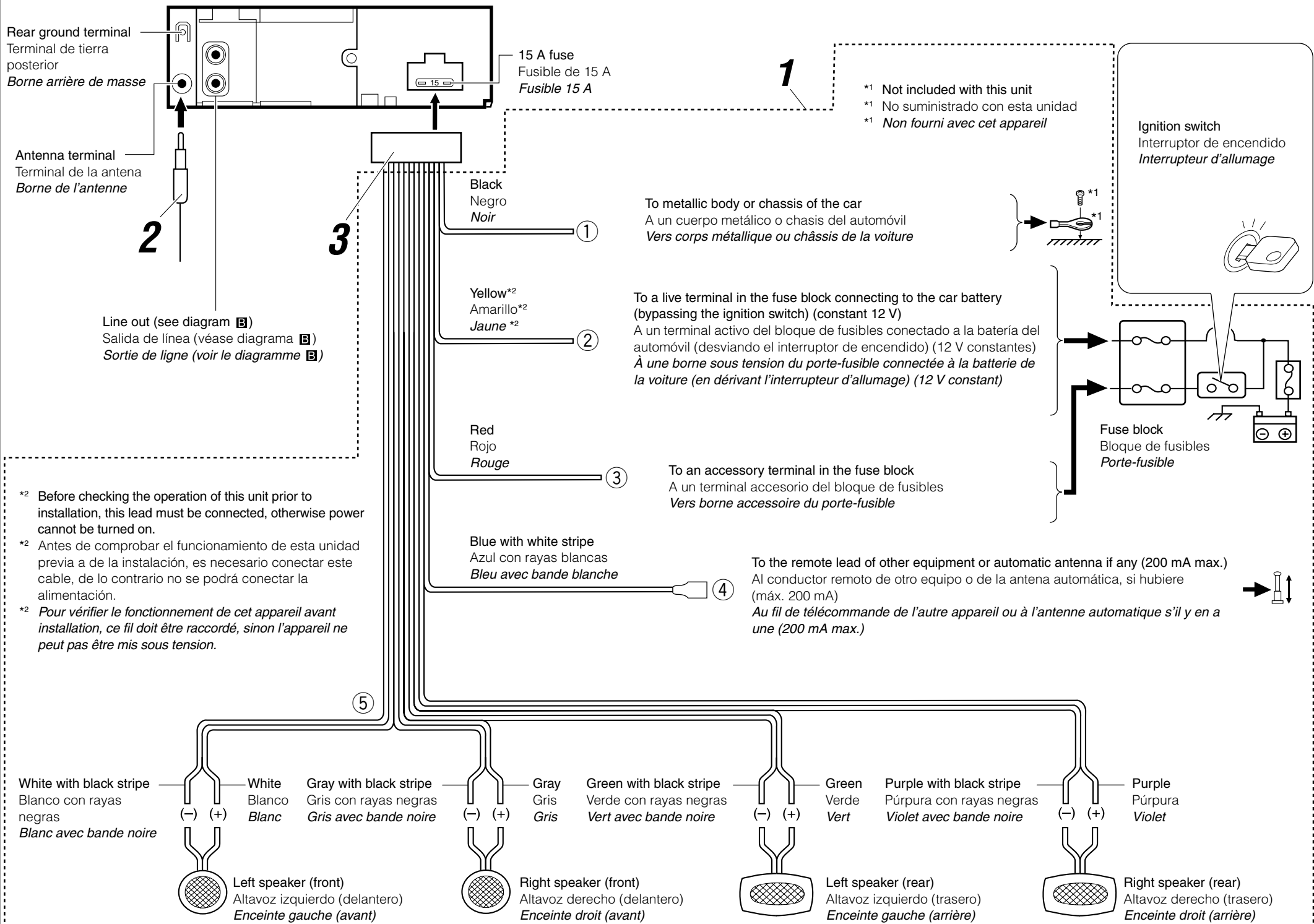

Amplifier / Amplificador / Amplificateur

You can connect an amplifier to upgrade your car stereo system.

- Connect the remote lead (blue with white stripe) to the remote lead of the other equipment so that it can be controlled through this unit.
- **Disconnect the speakers from this unit, connect them to the amplifier. Leave the speaker leads of this unit unused.**

Usted podrá conectar un amplificador para mejorar el sistema estéreo de su automóvil.

- Conecte el conductor remoto (azul con rayas blancas) al conductor remoto del otro equipo para poderlo controlar a través de esta unidad.
- **Desconecte los altavoces de esta unidad y conéctelos al amplificador. Los cables de los altavoces de esta unidad quedan sin usar.**

Vous pouvez connecter un amplificateur pour améliorer votre système autoradio.

- *Connectez le fil de commande à distance (bleu avec bande blanche) au fil de commande à distance de l'autre appareil de façon qu'il puisse être commandé via cet appareil.*
- **Déconnectez les enceintes de cet appareil et connectez-les à l'amplificateur. Laissez les fils d'enceintes de cet appareil inutilisés.**

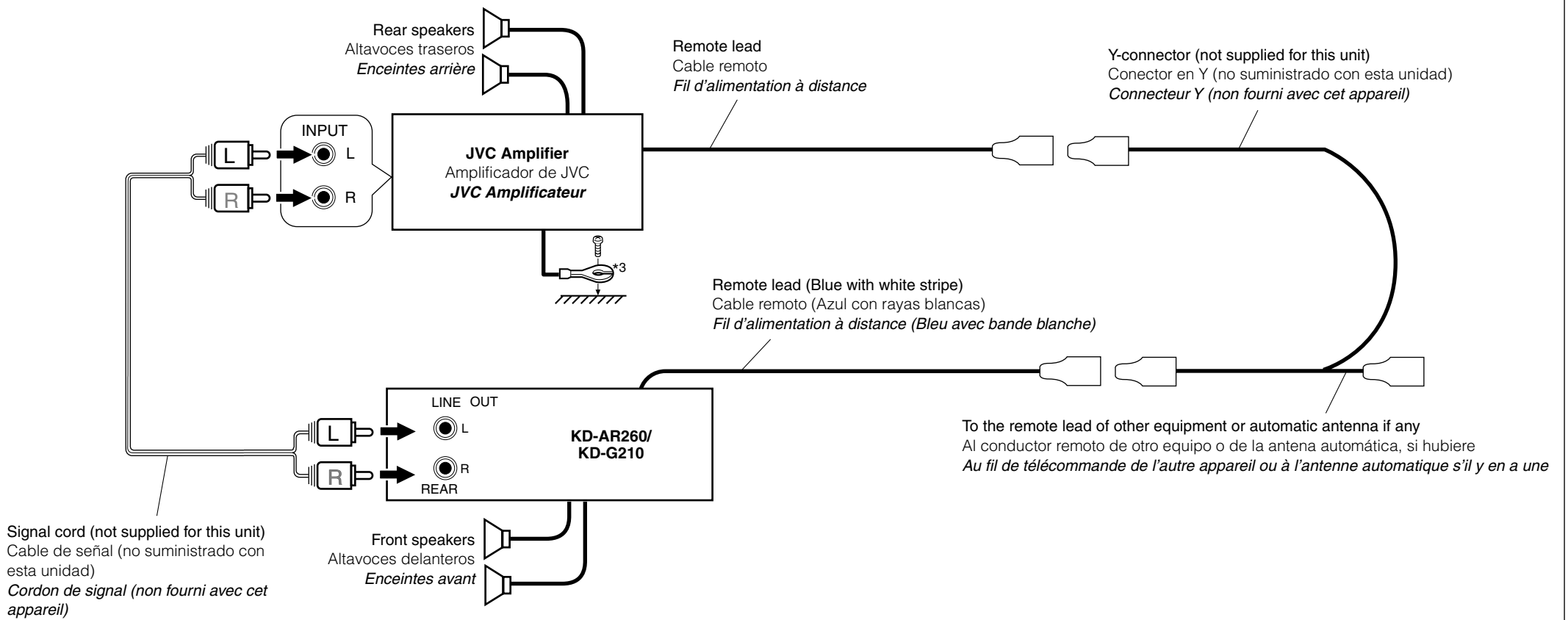

*3 Firmly attach the ground wire to the metallic body or to the chassis of the car—to the place not coated with paint (if coated with paint, remove the paint before attaching the wire). Failure to do so may cause damage to the unit.

*3 Fije firmemente el cable de tierra a la carrocería metálica o al chasis—a un lugar no cubierto con pintura (si está cubierto con pintura, quítela antes de fijar el cable). De lo contrario, se podrían producir daños en la unidad.

*3 Attachez solidement le fil de mise à la masse au châssis métallique de la voiture—à un endroit qui n'est pas recouvert de peinture (s'il est recouvert de peinture, enlevez d'abord la peinture avant d'attacher le fil). L'appareil peut être endommagé si cela n'est pas fait correctement.

PRECAUTIONS on power supply and speaker connections:

- **DO NOT** connect the speaker leads of the power cord to the car battery; otherwise, the unit will be seriously damaged.
- **BEFORE** connecting the speaker leads of the power cord to the speakers, check the speaker wiring in your car.

PRECAUCIONES sobre las conexiones de la fuente de alimentación y de los altavoces:

- **NO** conecte los conductores de altavoz del cable de alimentación a la batería de automóvil, pues podrían producirse graves daños en la unidad.
- **ANTES** de conectar a los altavoces los conductores de altavoz del cable de alimentación, verifique el conexionado de altavoz de su automóvil.

PRECAUTIONS sur l'alimentation et la connexion des enceintes:

- **NE CONNECTEZ PAS** les fils d'enceintes du cordon d'alimentation à la batterie; sinon, l'appareil serait sérieusement endommagé.
- **AVANT** de connecter les fils d'enceintes du cordon d'alimentation aux enceintes, vérifiez le câblage des enceintes de votre voiture.

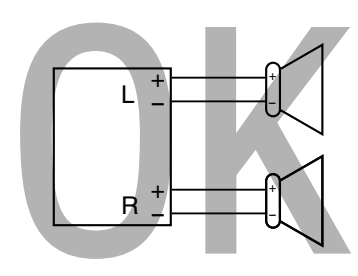
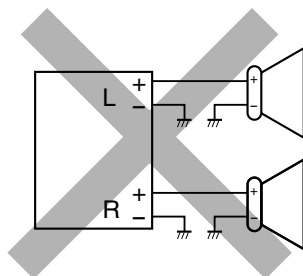
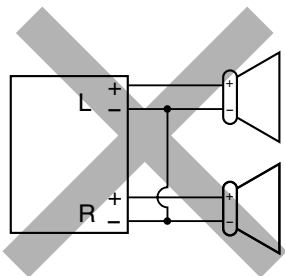

ENGLISH

BEFORE ELECTRICAL CONNECTIONS

The first and most important step in installation is to identify the wires inside the car you need to use. If you are not sure what wires are used for what purposes inside the car, read this sheet carefully.

What Leads Are inside the Car?

You need to identify the following leads used in the car (after removing an existing audio receiver or radio, if any, from your car).

| Leads inside the car | Function (and where to connect on the receiver) |
|---------------------------------|---|
| ① Battery lead | Supplies a continuous power to your receiver even when the ignition key is turned off. This lead provides a continuous power to maintaining the clock and internal memory in the receiver. – Connect this lead to the yellow wire of the receiver. |
| ② Power lead | Supplies power to your receiver when the ignition key is turned to the accessory position (ACC) or to the on position (ON). – Connect this lead to the red wire of the receiver. |
| ③ Speaker leads | Connects to the speakers inside the car. – Connect these leads to the corresponding speaker wires of the receiver. |
| ④ Automatic antenna lead | Supplies power to automatic power antenna if any. – If receiver has the blue-with-white-stripe wire, connect this lead to it. |
| ⑤ Antenna lead | Connects to the car antenna. – Connect to the antenna input terminal of the receiver. |

Required Tools

• Tools you must prepare:

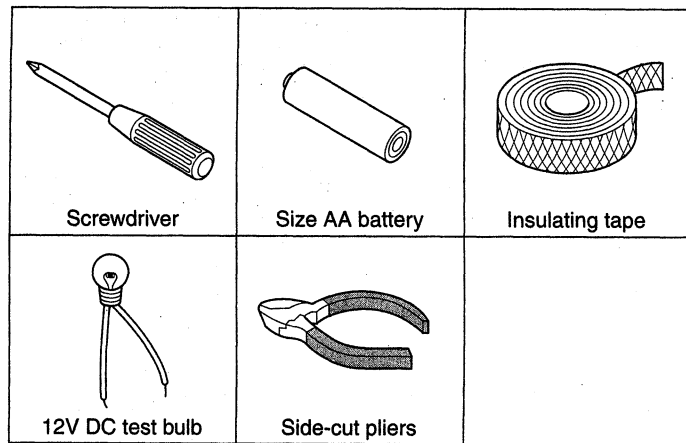

• Tools you had better prepare:



As you identify each lead, you can label it using masking tape and a permanent marker, and can note the colors of the leads used in the car. This will help avoid confusion when making connections later.

• For identifying method by using the above tools, see the reverse side.

ESPAÑOL

ANTES DE LAS CONEXIONES ELÉCTRICAS

El primer paso de la instalación y el más importante, es identificar cuáles son los cables del automóvil que se deben utilizar. Si tiene dudas acerca de los cables que se deben utilizar para cada propósito, lea esta hoja atentamente.

¿Qué conductores hay dentro del automóvil?

Es necesario que sepa identificar los siguientes conductores de su automóvil (tras desmontar el receptor de audio o la radio de su automóvil, si equiparse).

| Conductores del interior del automóvil (y punto de conexión en el receptor) | Función |
|---|---|
| ① Conductor de la batería | Suministra continuamente energía a su receptor incluso con el encendido desconectado. Este conductor suministra energía de manera continua para alimentar al reloj y a la memoria interna del receptor. – Conecte este conductor con el cable amarillo del receptor. |
| ② Conductor de alimentación | Suministra energía a su receptor con la llave de contacto en la posición de accesorios (ACC) o en la posición de conexión (ON). – Conecte este conductor con el cable rojo del receptor. |
| ③ Conductores de los altavoces | Efectúan la conexión con los altavoces del automóvil. – Conecte estos conductores con los correspondientes cables de altavoz del receptor. |
| ④ Conductor de antena automática | Suministra energía a la antena motriz automática, si hubiere. – Si el receptor tiene cable azul con rayas blancas, conéctele este conductor. |
| ⑤ Conductor de antena | Conecta con la antena del automóvil. – Conecte este conductor con el terminal de entrada de antena del receptor. |

Herramientas requeridas

• Herramientas que debe preparar:

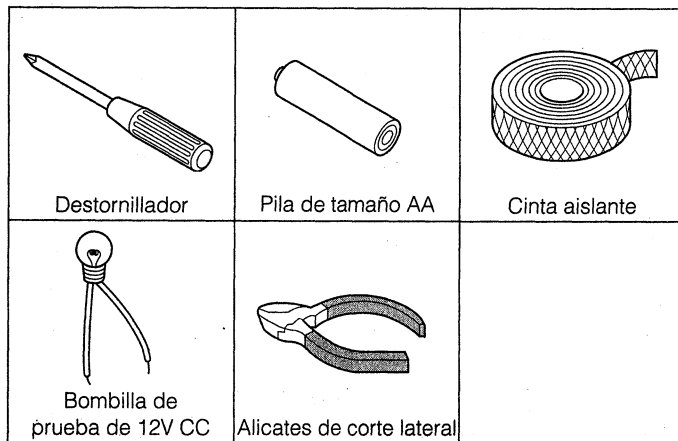

• Herramientas recomendadas:



A medida que vaya identificando cada conductor, podrá ponerle una etiqueta utilizando cinta enmascarante y rotulador, y anotar los colores de los conductores empleados en su automóvil. Esto le ayudará a evitar confusiones a la hora de realizar las conexiones.

• Con respecto al método de identificación utilizando las herramientas de arriba, véase al dorso.

FRANÇAIS

AVANT LES CONNEXIONS ÉLECTRIQUES

La première et plus importante étape de l'installation est l'identification des fils de la voiture que vous devez utiliser. Si vous ne savez pas quelle est l'utilisation de chaque fil, lisez cette feuille attentivement.

Quels sont les fils de votre voiture?

Vous devez identifier les fils suivants dans votre voiture (après avoir en avoir retiré l'actuel et éventuel autoradio).

| Fils à l'intérieur de la voiture | Fonction (et où connecter ces fils sur l'autoradio) |
|------------------------------------|---|
| ① Fil de batterie | Alimente en courant continu votre autoradio même quand le contact est coupé. Ce fil offre une alimentation continue qui permet de protéger l'horloge et la mémoire interne de l'autoradio. – Connectez ce fil au fil jaune de l'autoradio. |
| ② Fil d'alimentation | Alimente votre autoradio quand la clé de contact est mise sur la position accessoire (ACC) ou sur la position marche (ON). – Connectez ce fil au fil rouge de l'autoradio. |
| ③ Fils d'enceintes | Connectent les enceintes intérieures de la voiture. – Connectez ces fils aux fils correspondants sur l'autoradio. |
| ④ Fil d'antenne automatique | Alimente l'antenne automatique s'il y en a une. – Si l'autoradio possède un fil bleu à bandes blanches, connectez-y ce fil. |
| ⑤ Fil d'antenne | Connecte l'antenne de la voiture. – Connectez ce fil à la prise d'entrée d'antenne de l'autoradio. |

Outils nécessaires

• Outils à préparer:

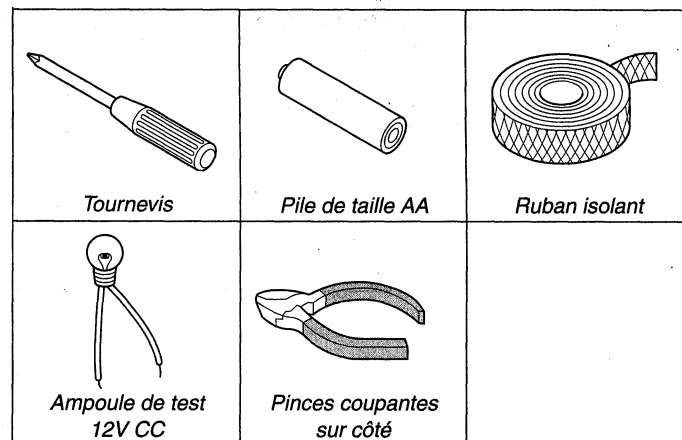

• Outils dont vous pouvez avoir besoin

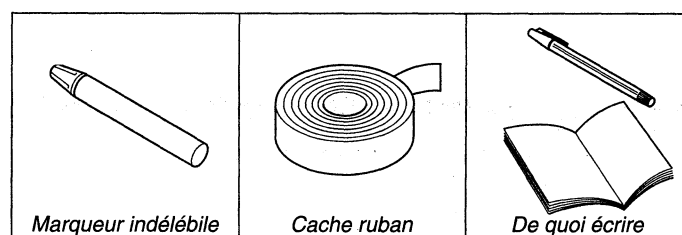

Au fur et à mesure que vous identifiez chaque fil, vous pouvez les étiqueter en utilisant le cache ruban et un marqueur indélébile et noter les couleurs des fils utilisés dans la voiture. Cela vous aidera à ne pas vous tromper lorsque vous ferez les connexions plus tard.

• Pour la méthode d'identification en utilisant les outils ci-dessus, reportez-vous au verso de cette feuille.

How to Identify the Leads inside the Car

Before start, make sure

- Check the speaker wiring inside the car first.
If speaker wiring is not appropriate (see "PRECAUTION on power supply and speaker connection" on the Installation/Connection Manual), first redo the speaker wiring inside the car.
- Pay much attention to avoid short-circuits. Insulate all exposed leads until you use them. Do not allow any exposed wire not in use to touch the metallic part or chassis of the car, and other exposed wires.
- If necessary, cut off the connector plug from leads coming from the car's battery (leaving the leads as long as possible) so that you can work with individual wires.

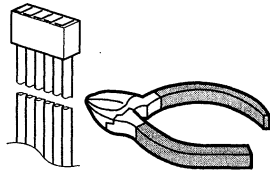

① Battery lead

■ If your car is pre-wired for the audio system:

- 1 Turn the ignition key to the off position (OFF).
- 2 Connect one lead of the test bulb to the metallic part or chassis of the car.
- 3 Touch the other lead of the test bulb to each wire inside the car.
 - Touch one wire at a time until you find a wire causing the test bulb to light. This wire is the battery lead.

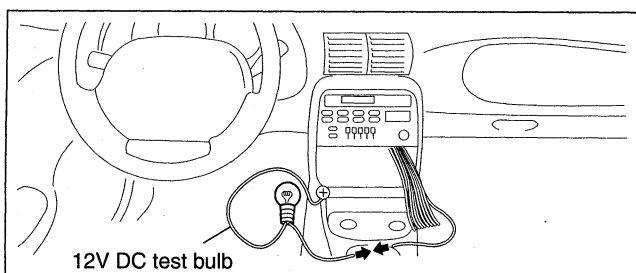

■ If your car is NOT pre-wired for the audio system:

Find the fuse port preparing for a continuous power supply from the battery (usually marked BAT).

② Power lead

■ If your car is pre-wired for the audio system:

- 1 Turn the ignition key to the accessory position (ACC).
- 2 Connect one lead of the test bulb to the metallic part or chassis of the car.
- 3 Touch the other lead of the test bulb to each wire inside the car.
 - Touch one wire at a time until you find a wire causing the test bulb to light.
- 4 If you find one, turn the ignition key off then on. If the test bulb also turns off and on, it is the power lead. If it does not turn off though you turn off the ignition key, it is the battery lead (see above).

■ If your car is NOT pre-wired for the audio system:

Find the fuse port preparing for a radio (RADIO) or an accessory (ACC) in the fuse block.

③ Speaker leads

Find two wires for each speaker by using a size AA battery as follows.

- 1 Turn the ignition key to the off position (OFF).
- 2 Touch one wire inside the car to one pole (+ or -) of the battery.
- 3 Touch another wire to the other of the battery.
If you hear a scraping noise from a speaker, you find a correct combination of the speaker leads for the speaker.
- 4 Repeat steps 1 and 2 until you find all combinations of speaker leads for the other speakers.

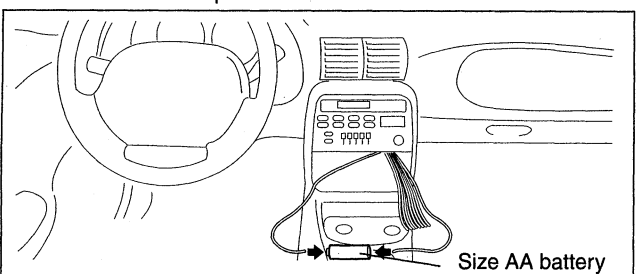

④ Automatic antenna lead

If your car is equipped with an automatic power antenna, find the automatic antenna lead.

- 1 Turn the ignition key to the accessory position (ACC).
- 2 Connect one lead of the test bulb to the battery lead (①) you have found.
- 3 Touch the other lead of the test bulb to each wire inside the car.
 - Touch one wire at a time until you find a wire causing the automatic power antenna to extend. This wire is the automatic antenna lead.

⑤ Antenna lead

This is a thick, black wire with a metal plug. Easily identified by its appearance. (See "A Typical Connections" on the Installation/Connection Manual.)

Cómo identificar los conductores empleados en el automóvil

Antes de comenzar, asegúrese de

- Comprobar primero el cableado de los altavoces del automóvil.
Si el cableado de los altavoces no es apropiado (consulte "PRECAUCIONES sobre la fuente de alimentación y la conexión de los altavoces" en el manual de instalación/conexión), primero deberá rehacer el cableado de los altavoces del interior del automóvil.
- Prestar suma atención para evitar cortocircuitos. Asegurarse de aislar todos los conductores al descubierto hasta el momento de utilizarlos. Ningún cable al descubierto sin utilizar deberá estar en contacto con alguna parte metálica o el chasis del automóvil o con otros cables al descubierto.
- Si es necesario, cortar la clavija de conexión y separarla de los conductores procedentes de la batería del automóvil (dejando los conductores lo más largo posible) de manera que pueda trabajar individualmente con cada cable.

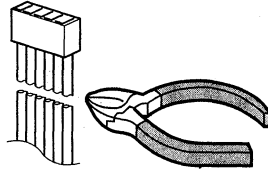

① Conductor de la batería

■ Si su automóvil está precableado para el sistema de audio:

- 1 Gire la llave de contacto a la posición de desconexión (OFF).
- 2 Conecte un conductor de la bombilla de prueba con la parte metálica o el chasis del automóvil.
- 3 Con el otro conductor de la bombilla de prueba toque uno por uno los cables del interior del automóvil.
 - Toque los cables de a uno hasta encontrar el que haga iluminar la bombilla de prueba. Este cable es el conductor de la batería.

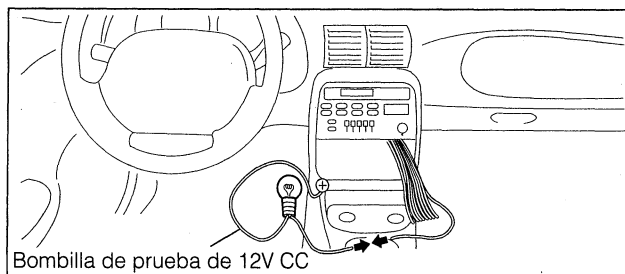

■ Si su automóvil NO está precableado para el sistema de audio:

Localice el puerto de fusible y prepárelo para suministrar continuamente energía desde la batería (normalmente marcado BAT).

② Conductor de alimentación

■ Si su automóvil está precableado para el sistema de audio:

- 1 Gire la llave de contacto a la posición de accesorios (ACC).
- 2 Conecte un conductor de la bombilla de prueba con la parte metálica o el chasis del automóvil.
- 3 Con el otro conductor de la bombilla de prueba toque uno por uno los cables del interior del automóvil.
 - Toque los cables de a uno hasta encontrar el que haga iluminar la bombilla de prueba.
- 4 Si lo encuentra, desconecte y vuelva a conectar la llave de contacto.
Si la bombilla de prueba también se apaga y se enciende, significa que es el conductor de alimentación.
Si la bombilla no se apaga al desconectar la llave de contacto, significa que se trata del conductor de la batería (véase arriba).

■ Si su automóvil NO está precableado para el sistema de audio:
Localice el puerto de fusible y prepárelo para la radio (RADIO) o un accesorio (ACC) en el bloque de fusibles.

③ Conductores de los altavoces

Utilizando una pila de tamaño AA, localice dos cables para cada altavoz, de la siguiente manera.

- 1 Gire la llave de contacto a la posición de desconexión (OFF).
- 2 Toque un polo (+ o -) de la pila con uno de los cables del interior del automóvil.
- 3 Toque el otro polo de la pila con otro cable.
Si el altavoz produce rechinar, significa que ha encontrado la combinación correcta de conductores para el altavoz.
- 4 Repita los pasos 1 y 2 hasta encontrar todas las combinaciones de conductores para los demás altavoces.

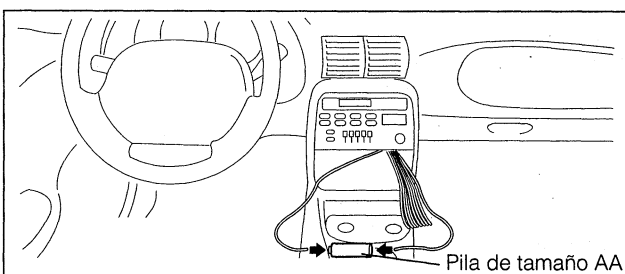

④ Conductor de antena automática

Si su automóvil se encuentra equipado con una antena motriz automática, localice el conductor de la antena automática.

- 1 Gire la llave de contacto a la posición de accesorios (ACC).
- 2 Conecte un conductor de la bombilla de prueba con el conductor de batería (①) localizada previamente.
- 3 Toque cada uno de los cables del interior del automóvil con el otro conductor de la bombilla de prueba.
 - Toque los cables de a uno hasta encontrar el que haga extender la antena motriz automática. Este cable es el conductor de antena automática.

⑤ Conductor de antena

Este es un cable grueso y negro con clavija de metal. Se identifica fácilmente por su apariencia. (Consulte "A Conexiones típicas" en el manual de instalación/conexión.)

Comment identifier les fils de votre voiture

Avant de commencer, veuillez vous assurer des choses suivantes

- Vérifiez d'abord le câblage des enceintes de la voiture.
Si le câblage des enceintes n'est pas correct (voir "PRÉCAUTIONS sur l'alimentation et la connexion des enceintes" dans le manuel d'installation/connexion), refaites d'abord le câblage des enceintes de la voiture.
- Faites attention d'éviter les courts-circuits. Isolez tous les fils à nu jusqu'à ce que vous les utilisiez. Ne laissez aucun fil à nu inutilisé toucher la partie métallique ou le châssis de la voiture ni les autres fils à nu.
- Si nécessaire, coupez la fiche de connexion des fils provenant de la batterie de la voiture (laissez les fils aussi longs que possible) de façon à pouvoir travailler sur un fil particulier.

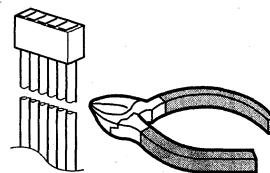

① Fil de batterie

■ Si votre voiture possède déjà un câblage pour système audio:

- 1 Mettez la clé de contact sur la position d'arrêt (OFF).
- 2 Connectez un fil de l'ampoule de test à une partie métallique ou au châssis de la voiture.
- 3 Avec l'autre fil de l'ampoule de test, touchez chaque fil de la voiture.
 - Touchez un fil à la fois jusqu'à ce que vous ayez trouvé celui qui allume l'ampoule de test. Ce fil est le fil de batterie.

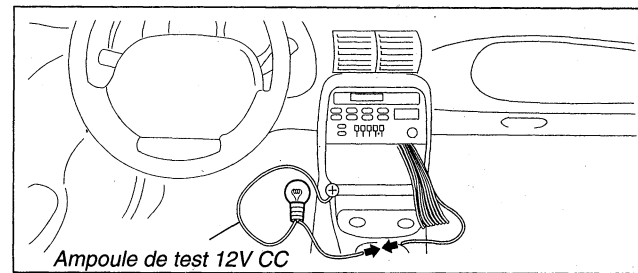

■ Si votre voiture ne possède pas de câblage pour système audio:

Trouvez la prise fusible prévue pour une alimentation continue à partir de la batterie (marquée habituellement BAT).

② Fil d'alimentation

■ Si votre voiture possède déjà un câblage pour système audio:

- 1 Mettez la clé de contact sur la position accessoire (ACC).
- 2 Connectez un fil de l'ampoule de test à une partie métallique ou au châssis de la voiture.
- 3 Avec l'autre fil de l'ampoule de test, touchez chaque fil de la voiture.
 - Touchez un fil à la fois jusqu'à ce que vous ayez trouvé celui qui allume l'ampoule de test. Ce fil est le fil de batterie.
- 4 Une fois que vous avez trouvé un fil, tournez la clé de contact sur la position d'arrêt (OFF) puis de nouveau en position accessoire.
Si l'ampoule de test s'éteint et s'allume aussi, c'est le fil d'alimentation.
Si elle ne s'éteint pas quand vous mettez la clé de contact en position d'arrêt, c'est le fil de batterie (voir ci-dessus).

■ Si votre voiture ne possède pas de câblage pour système audio:

Trouvez la prise fusible prévue pour la radio (RADIO) ou pour les accessoires (ACC) (marquée habituellement BAT) dans la boîte à fusibles.

③ Fils d'enceintes

Trouvez deux fils d'enceinte pour chaque enceinte en utilisant la pile AA de la façon suivante.

- 1 Mettez la clé de contact en position d'arrêt (OFF).
- 2 Touchez une des bornes de la pile (+ ou -) avec un des deux fils.
- 3 Touchez l'autre borne de la pile avec le deuxième fil.
Vous entendrez des grésillements dans une enceinte et cela vous permettra de trouver les combinaisons correctes des fils d'enceinte.
- 4 Répétez les étapes 1 et 2 jusqu'à ce que vous ayez trouvé toutes les combinaisons de fils de toutes les enceintes.

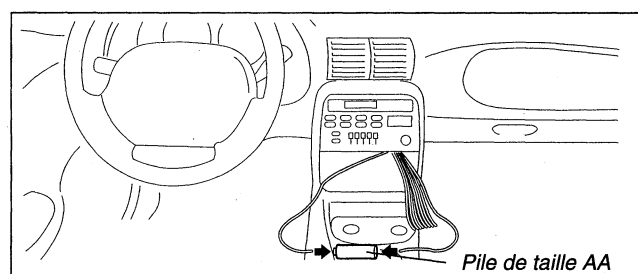

④ Fil d'antenne automatique

Si votre voiture est équipée d'une antenne électrique automatique, trouvez le fil correspondant.

- 1 Mettez la clé de contact sur la position accessoire (ACC).
- 2 Connectez un des fils de l'ampoule de test au fil de batterie (①) que vous avez trouvé.
- 3 Avec l'autre fil de l'ampoule de test, touchez chaque fil de la voiture.
 - Touchez un fil à la fois jusqu'à ce que vous ayez trouvé celui qui provoque le déploiement de l'antenne. C'est le fil d'antenne automatique.

⑤ Fil d'antenne

C'est un câble noir épais avec une fiche métallique. Elle peut être identifiée facilement par sa forme. (Reportez-vous à "A Connexions typiques" dans le manuel d'installation/connexion.)

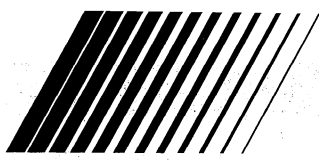

Having TROUBLE with operation?
Please check this
Troubleshooting Guide.
Still having trouble??

USA ONLY

Call 1-800-252-5722

<http://www.jvc.com>

We can help you!

Since the descriptions in this troubleshooting guide have been designated to be applied to JVC's standard CD Receiver, some of the functions and operations described may not be applied exactly to your receiver. If they cannot be applied exactly, refer also to the Instructions and Installation/Connection manual supplied with your receiver for details on the actual functions and operations, and cope with your troubles properly.

TROUBLESHOOTING GUIDE
For CD Receiver

| SYMPTOMS | CAUSES | REMEDIES |
|-------------------------------------|--|--|
| No sound comes out of the speakers. | The speaker wiring is not correctly finished. | Check if the speaker wiring is correctly finished, by referring to the Installation/Connection manual. |
| | Speaker cables are short-circuited. | Check if each cable is not cut or caught in the bracket or shorted by some other metallic parts. <i>To prevent any short-circuit, cover the ends of any unused cable with insulating tape.</i> |
| | Original speaker wiring in the car has a common ground for both left and right speakers or speaker wiring is earthed to the metallic body or chassis of the car. | Do not use the original speaker wiring in the car. Redo the speaker wiring by referring to the Installation/Connection manual. |
| | Speaker cable connection or soldering is not intact. | Check if the speaker cable connection is correct and intact, by using a tester or other measuring devices. |
| | Volume is set to the minimum level. | Adjust the volume to the optimum level. <i>If this does not work, check and adjust the fader and balance settings.</i> |
| | Power amplifier built in this unit has been deactivated. | Activate the built-in power amplifier by turning on the power amplifier on/off switch. <i>Refer to the Instructions manual.</i> |
| | When using an external power amplifier: The remote cable is not connected correctly. | Check if the remote cable connection is correct and intact, by using a tester or other measuring devices. |
| | The microcomputer built in this unit malfunctions due to noise, etc. | Press the Reset button, or press and hold the POWER and SEL buttons at the same time for more than 2 seconds to reset the microcomputer. <i>The clock setting and other preset setting such as preset stations will be erased.</i> |
| Others. | The unit is damaged. <i>Consult with your JVC car audio dealer.</i> | |

Troubleshooting for CD Receiver

| SYMPTOMS | CAUSES | REMEDIES |
|----------------------------|--|---|
| The unit does not turn on. | The power cords are not connected correctly. | Check if the connection is correctly finished, by referring to the Installation/Connection manual. |
| | | Check if the original wiring in the car has been correctly finished, especially on the following terminal connections — Constant 12 volts, ACC (accessory), ground. |
| | A fuse has blown (in the unit or in the fuse block of the car). | Check if the connection and the original wiring in the car are correct, then replace the fuse. <i>If the fuse blows frequently, consult with your JVC car audio dealer.</i> |
| | The ground cable is not correctly earthed. | Check if the ground cable connection is correct and intact, by using a tester or other measuring devices. <i>If the ground cable is connected to a painted metallic part, sand off the paint from or connect to an unpainted metallic part.</i> |
| | Wiring is short-circuited. | Check if each cable is not cut or caught in the bracket or shorted by some other metallic parts. |
| | The car battery is exhausted. (The voltage power is less than 11 volts.) | Have the car battery and electrical system checked so that a proper output voltage (11 to 16 volts) is obtained. CAUTION: NEVER use a 24-volt battery. |
| | The microcomputer built in this unit malfunctions due to noise, etc. | Press the Reset button, or press and hold the POWER and SEL buttons at the same time for more than 2 seconds to reset the microcomputer. <i>The clock setting and other preset setting such as preset stations will be erased.</i> |
| Others. | The unit is damaged. <i>Consult with your JVC car audio dealer.</i> | |

| SYMPTOMS | CAUSES | REMEDIES |
|------------------------------------|--|--|
| CD sound is sometimes interrupted. | Used while driving on rough roads. (The unit is subjected to extreme shock.) | Check if the unit can play back a CD normally on a flat road. |
| | CD is scratched. | Check if the unit can play back another CD normally. <i>If CD sound is not interrupted while playing back another CD, there is nothing wrong with this unit.</i> |
| | CD is stained by fingerprints, grease, etc. | Clean CD with a commercially available cleaner. |
| | Pickup lens inside the unit is stained. | Clean the lens by using a commercially available pickup lens cleaner. CAUTION: NEVER use a cleaner with a detachable brush. |
| | Interference from the cellular phone. | Keep the phone away from the unit. |
| | The microcomputer built in this unit malfunctions due to noise, etc. | Press the Reset button, or press and hold the POWER and SEL buttons at the same time for more than 2 seconds to reset the microcomputer. <i>The clock setting and other preset setting such as preset stations will be erased.</i> |
| | Others. | The unit is damaged. <i>Consult with your JVC car audio dealer.</i> |

| SYMPTOMS | CAUSES | REMEDIES |
|-----------------------------------|--|--|
| The unit does not operate at all. | Detachable control panel connection is not intact. | Clean the connectors on both detachable control panel and on the main unit, by referring to the Instructions manual. |
| | The microcomputer built in this unit malfunctions due to noise, etc. | Press the Reset button, or press and hold the POWER and SEL buttons at the same time for more than 2 seconds to reset the microcomputer. <i>The clock setting and other preset setting such as preset stations will be erased.</i> |
| | Others. | The unit is damaged. <i>Consult with your JVC car audio dealer.</i> |

| SYMPTOMS | CAUSES | REMEDIES |
|-------------------------------------|--|---|
| CD is ejected and cannot be played. | CD is inserted upside down. | Insert the CD correctly with the printed surface facing up. |
| | CD is scratched. | Check if the unit can play back another CD normally. <i>If the unit can play back another CD normally, there is nothing wrong with this unit.</i> |
| | CD is stained by fingerprints, grease, etc. | Clean CD with a commercially available cleaner. |
| | Pickup lens inside the unit is stained. | Clean the lens by using a commercially available pickup lens cleaner. CAUTION: NEVER use a cleaner with a detachable brush. |
| | Moisture may condense on the pickup lens inside the unit. | Eject the CD and leave the unit turned on for a few hours until the moisture evaporates. |
| | The microcomputer built in this unit malfunctions due to noise, etc. | Press the Reset button, or press and hold the POWER and SEL buttons at the same time for more than 2 seconds to reset the microcomputer. <i>The clock setting and other preset setting such as preset stations will be erased.</i> |
| | Others. | The unit is damaged. <i>Consult with your JVC car audio dealer.</i> |

| SYMPTOMS | CAUSES | REMEDIES |
|--------------------------|--|--|
| No station can be tuned. | No station uses the tuned frequency. | Tune into the correct station frequency. |
| | Antenna connection is not correct or intact. | Check if the connection is correct and intact. |
| | Antenna plug from the car does not fit into the unit. | Use an antenna adaptor. <i>Consult with your JVC car audio dealer with regard to an antenna adaptor.</i> |
| | Power antenna cannot be extended automatically. | Check if the remote cable connection is correct and intact, by using a tester or other measuring devices. |
| | Antenna booster is not switched on. | Check if the remote cable is correctly connected to the antenna booster. |
| | Remote cable is overloaded with a high electric current. | The remote cable can be loaded with up to 200 mA. The device requiring more than 200 mA (i.e. power supply of an external amplifier) should not be connected. <i>When connecting such a device requiring a high electric current, consult with your JVC car audio dealer.</i> |
| | The microcomputer built in this unit malfunctions due to noise, etc. | Press the Reset button, or press and hold the POWER and SEL buttons at the same time for more than 2 seconds to reset the microcomputer. <i>The clock setting and other preset setting such as preset stations will be erased.</i> |
| | Others. | The unit is damaged. <i>Consult with your JVC car audio dealer.</i> |

| SYMPTOMS | CAUSES | REMEDIES |
|-----------------------------|--|---|
| CD-R cannot be played back. | Recording format of the CD-R cannot be treated on this unit. | <i>Consult with the application company from which you purchased the CD-R recording software.</i> |
| | CD-R, disc itself, cannot be treated on this unit. | <i>Consult with the company making the discs you purchased.</i> |

| SYMPTOMS | CAUSES | REMEDIES |
|------------------------|--|---|
| CD cannot be inserted. | Another CD has already been in the CD compartment. | Eject the CD already inserted, then insert a CD. |
| | CD player malfunctions. | Press and hold the POWER and EJECT buttons at the same time for more than 2 seconds. |
| | The microcomputer built in this unit malfunctions due to noise, etc. | Press the Reset button, or press and hold the POWER and SEL buttons at the same time for more than 2 seconds to reset the microcomputer. <i>The clock setting and other preset setting such as preset stations will be erased.</i> |
| | Others. | The unit is damaged. <i>Consult with your JVC car audio dealer.</i> |

| SYMPTOMS | CAUSES | REMEDIES |
|----------------------------------|--|---|
| CD changer does not work at all. | The unit is not connected to the CD changer correctly. (When this is the cause, "R 8" or "RESET 8" appears on the display.) | Connect the unit and the CD changer correctly and press the reset button of the CD changer. |
| | No power is supplied to the CD changer. | Check if the short pin or power cord is connected correctly to the CD changer. |
| | Ejection mechanism error. (When this is the cause, "R 1" or "RESET 1" appears on the display.) | Press the reset button of the CD changer. |
| | Lifter (disc up/down) motor mechanism error. (When this is the cause, "R 2" or "RESET 2" appears on the display.) | Press the reset button of the CD changer. |
| | Tray (out/in) motor mechanism error. (When this is the cause, "R 3" or "RESET 3" appears on the display.) | Press the reset button of the CD changer. |
| | Pickup mechanism error (not return to the reset position when ejecting CD). (When this is the cause, "R 4" or "RESET 4" appears on the display.) | Press the reset button of the CD changer. |
| | Bus protocol error (signal transmission error). (When this is the cause, "R 6" or "RESET 6" appears on the display.) | Press the reset button of the CD changer. |
| | The microcomputer built in this unit malfunctions due to noise, etc. | Press the Reset button, or press and hold the POWER and SEL buttons at the same time for more than 2 seconds to reset the microcomputer. <i>The clock setting and other preset setting such as preset stations will be erased.</i> |
| | Others. | The unit is damaged. <i>Consult with your JVC car audio dealer.</i> |

| SYMPTOMS | CAUSES | REMEDIES |
|-----------------------|--|---|
| CD cannot be ejected. | CD ejection is prohibited. | Press and hold the CD and EJECT buttons at the same time for more than 2 seconds. |
| | CD player malfunctions. | Press and hold the POWER and EJECT buttons at the same time for more than 2 seconds. |
| | The microcomputer built in this unit is not functioning correctly due to noise, etc. | Press the Reset button, or press and hold the POWER and SEL buttons at the same time for more than 2 seconds to reset the microcomputer. <i>The clock setting and other preset setting such as preset stations will be erased.</i> |
| | Others. | The unit is damaged. <i>Consult with your JVC car audio dealer.</i> |

WHEN IT IS NOT REQUIRED
TO DETACH THE FRONT CONTROL
PANEL FROM THE MAIN UNIT,
USE THE PROVIDED SCREW TO
ATTACH THE CONTROL PANEL TO
THE MAIN UNIT.

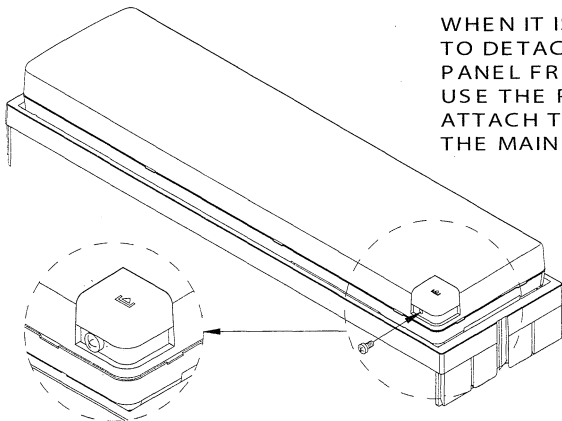

GE40201-001A



CAUTION

CONNECT BLACK WIRE (① GND) TO GROUND FIRST.
OTHERWISE, DAMAGE TO YOUR UNIT MAY OCCUR.

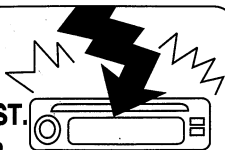

CAUTION

INCORRECT CONNECTION CAUSES SERIOUS
DAMAGE TO THIS UNIT.
PLEASE READ INSTALLATION/CONNECTION
MANUAL CAREFULLY.

Thank you for purchasing

JVC[®]

Instructions
Fold so opening is at the top.
Tape in middle or on front.

Please do not send products or other
correspondence to this address.

307C



PLACE
FIRST-CLASS
STAMP
HERE

JVC[®]
PO BOX 3434
PEORIA IL 61612-3434



PRODUCT REGISTRATION CARD/QUESTIONNAIRE

US CUSTOMERS ONLY

Registering your product will allow us to contact you in the unlikely event a product safety notification is required.

This form is for Product Registration purposes only. Failure to return this form does not diminish your rights during the warranty period.

THANK YOU FOR PURCHASING THIS JVC PRODUCT

REGISTER ONLINE AT: WWW.JVC.COM

First Name: _____
Last Name: _____
Address: _____
Apt #": _____
City: _____
State: _____
Zip: _____
Phone: _____
Email Address: _____

**Thank you! We appreciate your responses to this questionnaire.
The information you choose to share with us will be used by JVC to offer you
product information and other communications that may interest you.
If you prefer not to be contacted about these special offers, please check here. { }**

Date of Purchase _____
Model Number _____
Serial Number _____
Purchase Price _____
Dealer _____

1) Did you:

- Purchase this product your self?
- Receive this product as a gift?

5) Your Gender:

- Male
- Female

2) Is this Product:

- The first product of this type you have ever owned?
- A replacement for a similar JVC product?
- A replacement for a similar product made by another company?
- An addition to a similar product you are still using?

6) Your Marital Status

- Married
- Single

3) What factors most influenced your decision to purchase this product?

- JVC brand reputation
- Previous experience with JVC products
- Price
- Specific product features
- Style/appearance
- Salesperson's recommendation
- Friend/relative's recommendation
- Warranty coverage
- Other

7) What is your approximate annual household income level?

- Under \$25,000
- \$25,000 – \$49,000
- \$50,000 – \$74,000
- \$75,000 – \$99,000
- \$100,000 and over

Comments:

4) How did you learn about this product?

- Magazine Advertisement
- Newspaper Advertisement
- TV/Radio Announcement
- Product Brochure
- Direct Mail
- Mail Order Catalog
- Friend/Relative Recommendations
- Salesperson/Store Recommendation
- Internet
- Dealer Event
- Other

JVC Thanks you for completing this questionnaire.

Your responses will help us reach you with offers that may interest you.

If you prefer not to receive these offers please check here { }

TO OUR VALUED CUSTOMER ———

THANK YOU FOR PURCHASING THIS JVC PRODUCT.
WE WANT TO HELP YOU ACHIEVE A PERFECT EXPERIENCE.

**NEED HELP ON HOW TO HOOK UP?
NEED ASSISTANCE ON HOW TO OPERATE?
NEED TO LOCATE A JVC SERVICE CENTER?
LIKE TO PURCHASE ACCESSORIES?**

JVC[®] IS HERE TO HELP!
TOLL FREE: 1(800)252-5722
<http://www.jvc.com>

Remember to retain your Bill of Sale for Warranty Service.

————— **Do not attempt to service the product yourself** —————

Caution

To prevent electrical shock, do not open the cabinet.
There are no user serviceable parts inside.
Please refer to qualified service personnel for repairs.



LIMITED WARRANTY

AUDIO-2 **USA ONLY**

ONLY FOR PRODUCT PURCHASED IN U.S.A.

JVC COMPANY OF AMERICA (JVC) warrants this product and all parts thereof, except as set forth below ONLY TO THE ORIGINAL RETAIL PURCHASER to be FREE FROM DEFECTIVE MATERIALS AND WORKMANSHIP from the date of original purchase for the period shown below. ("The Warranty Period")

| | | | |
|-------|--------------|-------|--------------|
| PARTS | 2 YRS | LABOR | 2 YRS |
|-------|--------------|-------|--------------|

THIS LIMITED WARRANTY IS VALID ONLY IN THE FIFTY (50) UNITED STATES, THE DISTRICT OF COLUMBIA AND IN THE COMMONWEALTH OF PUERTO RICO.

WHAT WE WILL DO:

If this product is found to be defective within the warranty period, JVC will repair or replace defective parts with new or rebuilt equivalents at no charge to the original owner. Such repair and replacement services shall be rendered by JVC during normal business hours at JVC authorized service centers. Parts used for replacement are warranted only for the remainder of the Warranty Period. All products may be brought to a JVC authorized service center on a carry-in basis. Color televisions with a screen size of 27" or greater qualify for in-home service. In such cases, a technician will come to your home and either repair the TV there or remove and return it if it cannot be repaired in your home.

WHAT YOU MUST DO FOR WARRANTY SERVICE:

Please do not return your product to the retailer

Instead, return your product to the JVC authorized service center nearest you. If shipping the product to the service center, please be sure to package it carefully, preferably in the original packaging, and include a brief description of the problem(s). Please call 1-800-252-5722 to locate the nearest JVC authorized service center. Service locations can also be obtained from our website <http://www.jvc.com>. If your product qualifies for in-home service, the service representative will require clear access to the product.

If you have any questions concerning your JVC Product, please contact our Customer Relations Department at 800-252-5722

WHAT IS NOT COVERED:

This limited warranty provided by JVC does not cover:

1. Products which have been subject to abuse, accident, alteration, modification, tampering, negligence, misuse, faulty installation, lack of reasonable care, or if repaired or serviced by anyone other than a service facility authorized by JVC to render such service, or if affixed to any attachment not provided with the products, or if the model or serial number has been altered, tampered with, defaced or removed;
2. Initial installation, installation and removal from cabinets or mounting systems.
3. Operational adjustments covered in the Owner's Manual, normal maintenance, video and audio head cleaning;
4. Damage that occurs in shipment, due to act of God, and cosmetic damage;
5. Signal reception problems and failures due to line power surge;
6. Video Pick-up Tubes/CCD Image Sensors are covered for 90 days from the date of purchase;
7. Accessories;
8. Batteries (except that Rechargeable Batteries are covered for 90 days from the date of purchase);
9. Products used for commercial purposes, including, but not limited to rental.

There are no express warranties except as listed above.

THE DURATION OF ANY IMPLIED WARRANTIES, INCLUDING THE IMPLIED WARRANTY OF MERCHANTABILITY, IS LIMITED TO THE DURATION OF THE EXPRESS WARRANTY HEREIN.

JVC SHALL NOT BE LIABLE FOR ANY LOSS OF USE OF THE PRODUCT, INCONVIENCE, OR ANY OTHER DAMAGES, WHETHER DIRECT, INCIDENTAL OR CONSEQUENTIAL (INCLUDING, WITHOUT LIMITATION, DAMAGE TO TAPES, RECORDS OR DISCS) RESULTING FROM THE USE OF THIS PRODUCT, OR ARISING OUT OF ANY BREACH OF THIS WARRANTY. ALL EXPRESS AND IMPLIED WARRANTIES, INCLUDING THE WARRANTIES OF MERCHANTABILITY AND FITNESS FOR PARTICULAR PURPOSE, ARE LIMITED TO THE WARRANTY PERIOD SET FORTH ABOVE.

Some states do not allow the exclusion of incidental or consequential damages or limitations on how long an implied warranty lasts, so these limitations or exclusions may not apply to you. This warranty gives you specific legal rights and you may also have other rights which vary from state to state.

JVC COMPANY OF AMERICA
DIVISION OF JVC AMERICAS CORP.

1700 Valley Road
Wayne, NJ 07470

<http://www.jvc.com>

REFURBISHED PRODUCTS CARRY A SEPARATE WARRANTY, THIS WARRANTY DOES NOT APPLY. FOR DETAIL OF REFURBISHED PRODUCT WARRANTY, PLEASE REFER TO THE REFURBISHED PRODUCT WARRANTY INFORMATION PACKAGED WITH EACH REFURBISHED PRODUCT.

For customer use:

Enter below the Model No. and Serial No. which is located either on the rear, bottom or side of the cabinet. Retain this information for future reference.

Model No. : _____ Serial No. : _____
Purchase date : _____ Name of dealer : _____

Free Manuals Download Website

<http://myh66.com>

<http://usermanuals.us>

<http://www.somanuals.com>

<http://www.4manuals.cc>

<http://www.manual-lib.com>

<http://www.404manual.com>

<http://www.luxmanual.com>

<http://aubethermostatmanual.com>

Golf course search by state

<http://golfingnear.com>

Email search by domain

<http://emailbydomain.com>

Auto manuals search

<http://auto.somanuals.com>

TV manuals search

<http://tv.somanuals.com>