

JVC



ENGLISH

FRANÇAIS

CD/SD RECEIVER RECEPTEUR CD/SD

KD-SHX751

EXAD

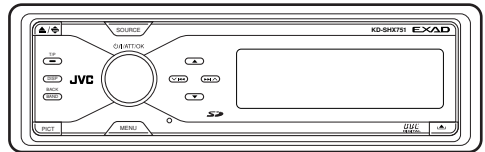
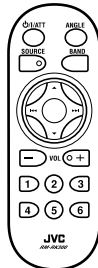
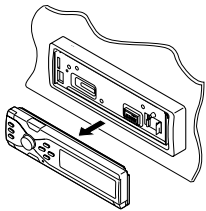

For canceling the display demonstration, see page 9.
Pour annuler la démonstration des affichages, référez-vous à la page 9.

For installation and connections, refer to the separate manual.
Pour l'installation et les raccordements, se référer au manuel séparé.

INSTRUCTIONS MANUEL D'INSTRUCTIONS

LVT1311-003A
[EX/EU]

Thank you for purchasing a JVC product.

Please read all instructions carefully before operation, to ensure your complete understanding and to obtain the best possible performance from the unit.

IMPORTANT FOR LASER PRODUCTS

1. CLASS 1 LASER PRODUCT
2. **CAUTION:** Do not open the top cover. There are no user serviceable parts inside the unit; leave all servicing to qualified service personnel.
3. **CAUTION:** Visible and invisible laser radiation when open and interlock failed or defeated. Avoid direct exposure to beam.
4. REPRODUCTION OF LABEL: CAUTION LABEL, PLACED OUTSIDE THE UNIT.

CAUTION: Visible and invisible laser radiation when open and interlock failed or defeated. AVOID DIRECT EXPOSURE TO BEAM.	ADVARSEL: Synlig og usynlig laserstråling når maskinen er åben eller interlocken fejler. Undgå direkte eksponering til strålingen.	VARNING: Synlig och osynlig laserstråling när den öppnas och spärren är lurkopplad. Beträkta ej strålen.	VARO: Arvattassa ja suojalukitus ohitettuna tai viallisena olet alitina näkyvälle ja näkymättömälle lasersträlylle. Vältä säteiden kohollistamista suoraan itseesi. (f)
--	---	---	--

Warning:

If you need to operate the receiver while driving, be sure to look ahead carefully or you may be involved in a traffic accident.

Cautions:

- Do not insert 8 cm discs (single CDs) into the loading slot. (Such discs cannot be ejected.)
- Do not insert any disc of unusual shape—like a heart or flower; otherwise, it will cause a malfunction.
- Do not expose discs to direct sunlight or any heat source or place them in a place subject to high temperature and humidity. Do not leave them in a car.

How to reset your unit

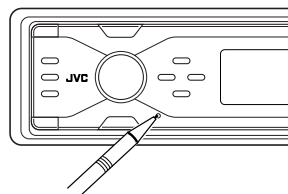

This will reset the microcomputer. Your preset adjustments will also be erased.

Notice:

The display window built in this receiver has been produced with high precision, but it may have some ineffective dots. This is inevitable and is not malfunction.

Note: Only for [EX] model users in UK and European countries

For security reasons, a numbered ID card is provided with this receiver, and the same ID number is imprinted on the receiver's chassis. Keep the card in a safe place, as it will help the authorities to identify your receiver if stolen.

Contents

How to reset your unit	2	Sound adjustments	25
How to read this manual	4	Selecting the DSP modes—DSP	25
How to forcibly eject a disc	4	Making sound natural	27
How to change the display pattern	5	Setting the basic sound selection menu	
How to enter the various menus	5	—SEL	28
Control panel — KD-SHX751	6	Selecting preset sound modes—EQ	29
Parts identification	6	Storing your own sound modes	30
Remote controller —		Graphic displays	31
RM-RK300	7	Basic procedure	31
Main elements and features	7	Downloading the files	32
Getting started	8	Deleting the files	33
Basic operations	8	Activating the downloaded files	35
Canceling the display demonstration	9	General settings — PSM	36
Setting the clock	9	Basic procedure	36
Radio operations	10	Selecting the dimmer mode	40
Listening to the radio	10	Other main functions	41
Storing stations in memory	11	Assigning titles to the sources	41
Listening to a preset station	12	Changing the control panel angle	42
FM RDS operations	13	Detaching the control panel	42
Searching for your favorite FM RDS		External component operations...	43
programme	13	Playing an external component	43
Storing your favorite programmes	14	DAB tuner operations	44
Using the Standby Receptions	15	Listening to the DAB tuner	44
Tracking the same programme—		Storing DAB services in memory	46
Network-Tracking Reception	16	Tuning in to a preset DAB service	46
Using the message service—		Using the Standby Receptions	47
RDS Radiotext (RT)	16	Tracing the same programme—	
Disc/SD card operations	17	Alternative Frequency Reception	48
Playing a disc in the receiver	17	Maintenance	49
Playing discs in the CD changer	18	More about this receiver	50
Playing an SD card	19	Troubleshooting	54
Other main functions	21	Specifications	57
Selecting the playback modes	23		

For safety....

- Do not raise the volume level too much, as this will block outside sounds, making driving dangerous.
- Stop the car before performing any complicated operations.



Temperature inside the car....

If you have parked the car for a long time in hot or cold weather, wait until the temperature in the car becomes normal before operating the unit.

How to read this manual

The following methods are used to make the explanations simple and easy-to-understand:

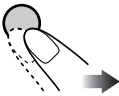
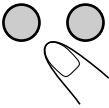
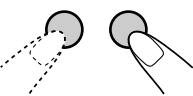
- Some related tips and notes are explained in “More about this receiver” (see pages 50 – 53).
- Button operations are mainly explained with the illustrations as follows:

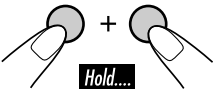
	Press briefly.
	Press repeatedly.
	Press either one.
	
	Press and hold until your desired response begins.
	Press and hold both buttons at the same time.

The following marks are used to indicate...



: Built-in CD player operations.



: External CD changer operations.



: SD card operations.

How to forcibly eject a disc

If a disc cannot be recognized by the receiver or cannot be ejected, eject the disc as follows.

- If an SD card is inserted, eject the SD card first (see page 19).

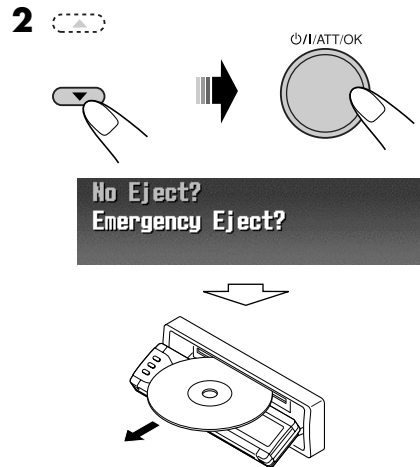
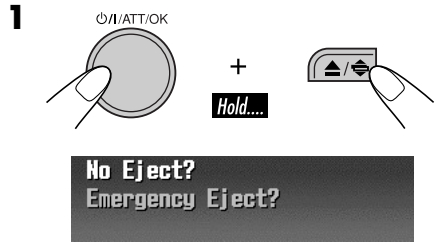

- If this does not work, reset your receiver.
- Be careful not to drop the disc when it ejects.

Caution on volume setting:

Discs produce very little noise compared with other sources. Lower the volume before playing a disc to avoid damaging the speakers by the sudden increase of the output level.

How to change the display pattern

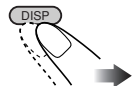

Ex.: When tuner is selected as the source



Source operation screen

Some other information appears for FM RDS stations and DAB services.*1



“Small” (CD jacket image) graphic*2 is displayed.



“Large” (full screen size) graphic*2 is shown as the display background.



Graphic screen*2

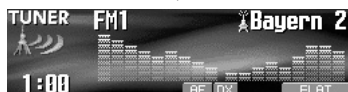

Audio level meters are displayed (see “LevelMeter” on page 36).

Goes back to the initial display pattern.

*1 For FM RDS, see page 16.
For DAB, see page 48.

*2 You can use your edited file for graphic screen (see pages 31 – 35).
Depending on a downloaded file, it may take longer time to show it on the display.

*3 The information bar will disappear if no operation is performed.

How to enter the various menus

The main menu contains the following menus —MODE, PSM, SEL, PICT, DSP, CCC, TITLE, EQ, and BBE.

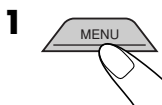

2 Move the cursor to select a menu you want (MODE, PSM, SEL, DSP, CCC, TITLE, EQ, BBE).

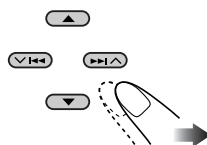

* Cursor

- To go back to the previous screen, press BACK.

* Works as time countdown indicator.

3 Enter the selected menu.

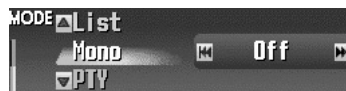

Ex.: When MODE menu is selected

- To go back to the MENU screen, press MENU.

4 Operate as instructed on the screen.

Parts identification

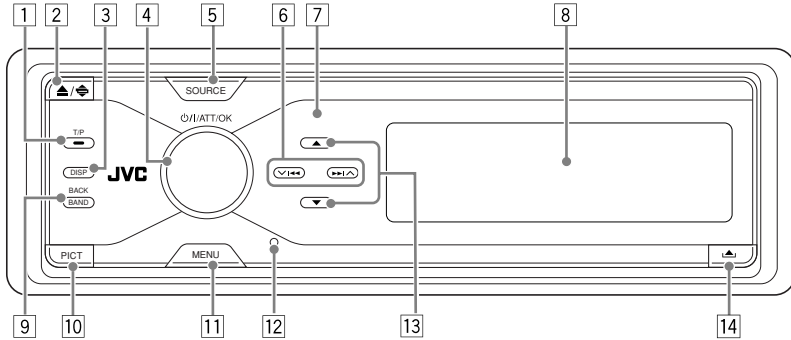

1 T/P (traffic programme/programme type) button

- Turns on/off TA (Traffic Announcement) Standby Reception (see page 15) if pressed.
- Displays the PTY operation screen (see page 13) if pressed and held.

2 ▲ (eject)/ ⚙ (angle) button

- Ejects the disc if pressed.
- Adjusts the control panel angle if pressed repeatedly after held once.

3 DISP (display) button

Changes the information shown on the display.

4 Ⓚ/1/ATT (standby/on/attenuator)/OK button

- Turns on and off the power and also attenuates the sound.
- Confirms the selection while operating the menus.

Volume control dial

Adjusts the volume level.

5 SOURCE button

Selects the source.

6 ◀◀/▶▶ (▼/▲) buttons

- **For FM/AM and DAB:** Searches for stations (or ensembles) if pressed, or skips frequencies after pressed and held.
- **For a disc or an SD card:** Changes the tracks if pressed, or fast-forwards or reverses the track if pressed and held.
- **For menu operations:** Selects the menu items/values.

7 Remote sensor

DO NOT expose the remote sensor on the control panel to strong light (direct sunlight or artificial lighting).

8 Color display window

9 BAND/BACK button

- **For FM/AM and DAB:** Selects the band.
- **For menu operations:** Goes back to the previous screen or cancels the setting.

10 PICT (picture) button

Displays the PICT menu.

11 MENU button

Displays the MENU screen.

12 Reset button

13 ▲ (up) / ▼ (down) buttons

- **For FM/AM:** Displays Preset Station List if pressed and held.
- **For DAB:** Changes the services if pressed, or displays Preset Service List if pressed and held.
- **For MP3/WMA discs or an SD card:** Changes the folders if pressed, or displays Disc List (only for "CD-CH") or Folder List if pressed and held.
- **For menu operations:** Selects the menu items/values.

14 ▲ (control panel release) button

Installing the lithium coin battery (CR2025)

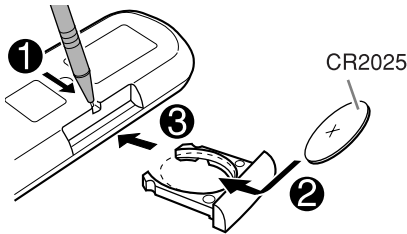

- When operating, aim the remote controller directly at the remote sensor on the receiver. Make sure there is no obstacle in between.

Warning:

- Do not install any battery other than CR2025 or its equivalent; otherwise, it may explode.
- Store the battery in a place where children cannot reach to avoid risk of accident.
- To prevent the battery from over-heating, cracking, or starting a fire:
 - Do not recharge, short, disassemble, or heat the battery or dispose of it in a fire.
 - Do not leave the battery with other metallic materials.
 - Do not poke the battery with tweezers or similar tools.
 - Wrap the battery with tape and insulate when throwing away or saving it.

Caution:

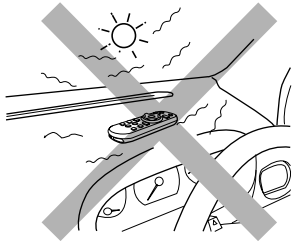

The receiver is equipped with the steering wheel remote control function.

- See the Installation/Connection Manual (separate volume) for connection.

Main elements and features

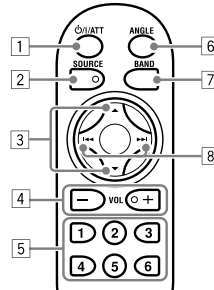

- ⏻/I/ATT (standby/on/attenuator) button**
Turns on and off the power and also attenuates the sound.
- SOURCE button**
Selects the source.
- ▲ (up) / ▼ (down) buttons**
 - **For DAB:** Changes the services.
 - **For MP3/WMA discs or an SD card:** Changes the folders.
- VOL (volume) + / - buttons**
Adjusts the volume level.
- Number buttons**
 - **For FM/AM and DAB:** Selects the preset station (or service) if pressed, or store a station (or a service) if pressed and held.
 - **For audio CDs or CD Texts:** Selects the tracks.
 - **For MP3/WMA discs or an SD card:** Selects the folders.
 - **For CD changer:** Selects the discs.
- ANGLE button**
Adjusts the control panel angle.
- BAND button**
Selects the band.
- ◀◀ / ▶▶ buttons**
 - **For FM/AM and DAB:** Searches for stations (or ensembles) if pressed, or skips frequencies after pressed and held.
 - **For a disc or an SD card:** Changes the tracks if pressed, or fast-forwards or reverses the track if pressed and held.

Getting started

Basic operations

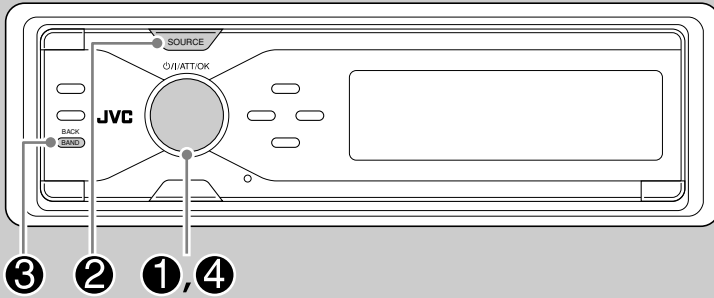

1 Turn on the power.

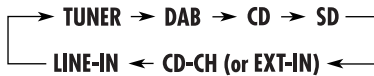
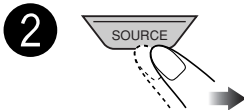

You cannot select some sources if they are not ready.

3 • For FM/AM tuner

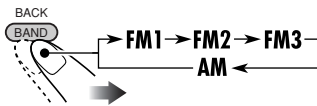

• For DAB tuner



4 Adjust the volume.



5 Adjust the sound as you want.
(See pages 25 – 30.)

To drop the volume in a moment (ATT)



To restore the sound, press it again.

To turn off the power



Canceling the display demonstration

If no operations are done for about 45 seconds, display demonstration starts.

[Initial: Demo]—see page 36.

1 Enter the PSM menu (see page 5).

2 Select “Off.”

- Make sure “Demo/Link” is shown on the display. If not, press ▲ or ▼.

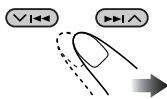

3 Finish the procedure.



To activate the display demonstration

In step **2** above, select “Demo” or “ImageLink.” For more details, see page 36.

Setting the clock

1 Enter the PSM menu (see page 5).

2 Set the hour, minute, and clock system.

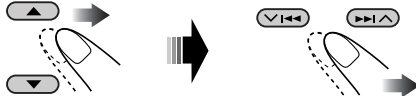

1 Select “Clock Hr” (hour), then adjust the hour.



2 Select “Clock Min” (minute), then adjust the minute.



3 Select “24H/12H,” then select “24H” or “12H.”



3 Finish the procedure.



Radio operations

Listening to the radio

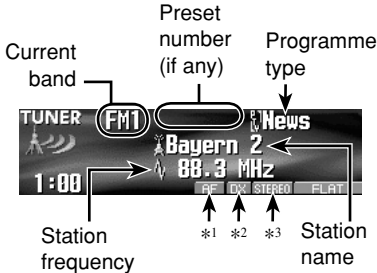
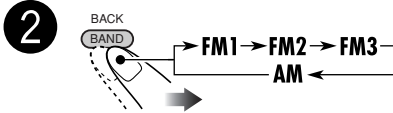
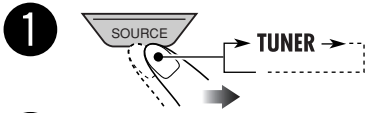
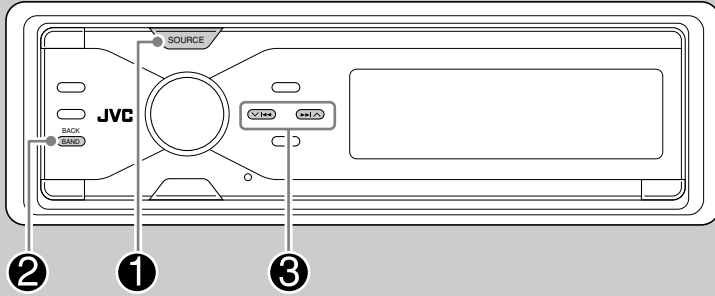

- *1 AF or REG indicator: See page 38.
- *2 LO or DX indicator: See page 11.
- *3 STEREO or MONO indicator:
 - STEREO indicator lights up when receiving an FM stereo broadcast with sufficient signal strength.
 - For MONO, see the right column.

3 Start searching for a station.



When a station is received, searching stops.

To stop searching, press the same button again.

To tune in to a station manually

In step 3 on the left...

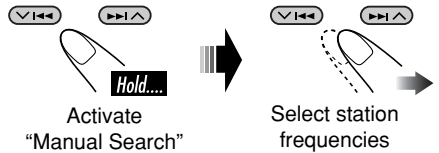

When an FM stereo broadcast is hard to receive

1 Enter the MODE menu (see page 5).

2 Select "Mono."



3 Select "On."

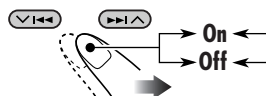

MONO indicator lights up.

Reception improves, but stereo effect will be lost.

4 Finish the procedure.



To restore the stereo effect, repeat the same procedure and select “Off” on step 3.

■ To tune in FM stations only with strong signals—LO/DX (Local/Distance-extreme)

If received signals are weak, you may only hear noises. You can make this unit detect only stations with sufficient signal strength while searching for FM stations.

1 Enter the MODE menu (see page 5).

2 Select “LO/DX.”



3 Select “Local.”

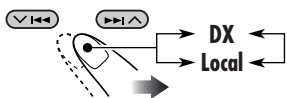

- **DX:** To tune in to all receivable stations. **DX** indicator lights up.
- **Local:** To tune in to only stations with sufficient signal strength. **LO** indicator lights up.

4 Finish the procedure.



Storing stations in memory

You can preset six stations for each band.

■ FM station automatic presetting—SSM (Strong-station Sequential Memory)

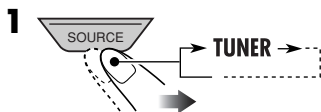

2 Select the FM band (FM1 – FM3) you want to store into.



3 Enter the MODE menu (see page 5).

4 Select “SSM.”

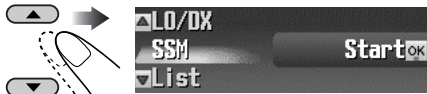

5

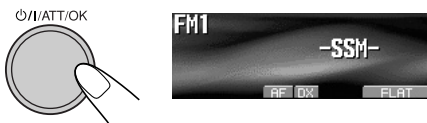

Local FM stations with the strongest signals are searched and stored automatically in the FM band.

To be continued....

Manual presetting

Ex.: Storing FM station of 92.5 MHz into preset number 3 of the FM1 band.

1

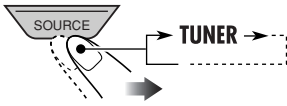

2



- If you hold ▲/▼, the Preset Station List will appear (see step 7 below).

3



4 Enter the MODE menu (see page 5).

5 Select "List."



6



7 Select a preset number.



- You can move to the lists of the other FM bands by pressing ◀◀▶▶ (▼/▲).

8 Store the station.



When using the remote controller...

After tuning in to a station you want to preset

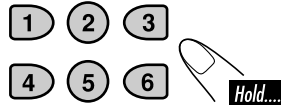

Listening to a preset station

1

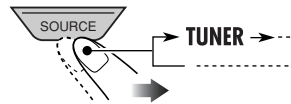

2



3 Perform steps 4 to 7 (on left column) to enter the Preset Station List.

4



When using the remote controller...

To directly select the preset number

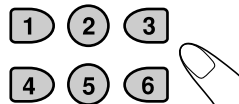

Searching for your favorite FM RDS programme

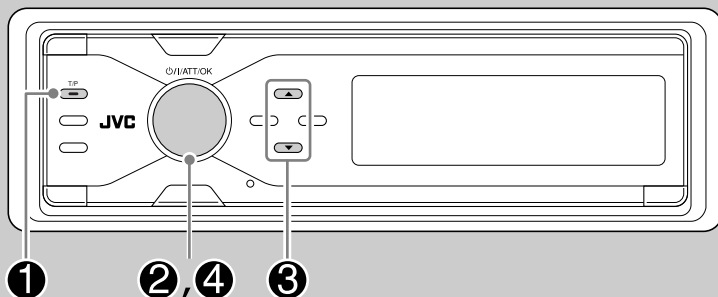

You can tune in to a station broadcasting your favorite programme by searching for a PTY code.

- To store your favorite programme, see page 14.

3 Select a PTY code.

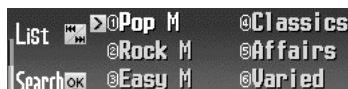
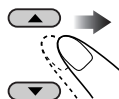

- You can move to the other lists by pressing \leftarrow / \rightarrow / \uparrow / \downarrow .

4 Start searching for your favorite programme.



If there is a station broadcasting a programme of the same PTY code as you have selected, that station is tuned in.

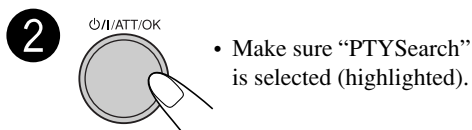
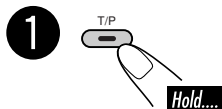

What you can do with RDS

RDS (Radio Data System) allows FM stations to send an additional signal along with their regular programme signals. By receiving the RDS data, this receiver can do the following:

- Programme Type (PTY) Search (see page 13)
- Temporarily switches to Traffic Announcement—TA Standby Reception (see page 15)
- Temporarily switches to your favorite programme—PTY Standby Reception (see pages 15 and 38)
- Tracing the same programme automatically—Network-Tracking Reception (see page 16)
- Programme Search (see page 38)
- Receiving the message service—RDS Radiotext (RT) (see page 16)

PTY codes

News, Affairs, Info, Sport, Educate, Drama, Culture, Science, Varied, Pop M (music), Rock M (music), Easy M (music), Light M (music), Classics, Other M (music), Weather, Finance, Children, Social, Religion, Phone In, Travel, Leisure, Jazz, Country, Nation M (music), Oldies, Folk M (music), Document

Storing your favorite programmes

You can store six favorite programme types.

Preset programme types:

1	2	3	4	5	6
Pop M	Rock M	Easy M	Classics	Affairs	Varied

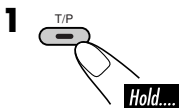

2 Select “PTYMemory.”



3



4 Select a preset number.



5 Select a PTY code.



6 Store the setting.



7 Repeat steps 4 to 6 to store other PTY codes into other preset numbers.

8 Finish the procedure.

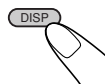

Using the Standby Receptions

TA Standby Reception

TA Standby Reception allows the receiver to switch temporarily to Traffic Announcement (TA) from any source other than AM.

The volume changes to the preset TA volume level (see page 38).

- If the DAB tuner is connected, Standby Reception also works to search for a DAB service broadcasting Traffic Announcement.

To activate TA Standby Reception



TP indicator appears.

- If the TP indicator lights up, TA Standby Reception is activated.
- If the TP indicator flashes, TA Standby Reception is not yet activated. (This occurs when you are listening to an FM station without the RDS signals required for TA Standby Reception.)

To activate TA Standby Reception, tune in to another station (or DAB service) providing these signals. The TP indicator will stop flashing and remain lit.

To deactivate the TA Standby Reception

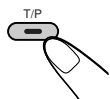

The TP indicator goes off.

PTY Standby Reception

PTY Standby Reception allows the receiver to switch temporarily to your favorite PTY programme from any source other than AM.

- If the DAB tuner is connected, Standby Reception also works to search for a DAB service.

To select your favorite PTY code for PTY Standby Reception, see page 38.

The PTY indicator either lights up or flashes.

To activate the PTY Standby Reception

1 Enter the MODE menu (see page 5).

2 Select “PTY.”



3 Select one of the PTY codes.



4 Finish the procedure.



PTY indicator appears.

- If the PTY indicator lights up, PTY Standby Reception is activated.
- If the PTY indicator flashes, PTY Standby Reception is not yet activated. To activate PTY Standby Reception, tune in to another station (or DAB service) providing these signals. The PTY indicator will stop flashing and remain lit.

To deactivate the PTY Standby Reception

Select “Off” in step **3** above.

The PTY indicator goes off.

Tracking the same programme— Network-Tracking Reception

When driving in an area where FM reception is not sufficient enough, this receiver automatically tunes in to another FM RDS station of the same network, possibly broadcasting the same programme with stronger signals (see the illustration on the right column).

When shipped from the factory, Network-Tracking Reception is activated.

To change the Network-Tracking Reception setting, see “AF-Regn’l” on page 38.

Using the message service— RDS Radiotext (RT)

What is RDS Radiotext

RDS Radiotext is part of the RDS data signal to transmit various text information (e.g. programme information, phone numbers, e-mail and web addresses, artist/title information and news headlines). The text service is part of the RDS broadcast. One message may contain up to 64 characters.

The message service is an optional service and is not supported by all broadcasters.

Once you tuned in to a station that supports the message service, the service is automatically received.

To show the RDS Radiotext (RT) information

While listening to a station that supports RT...



Radiotext is displayed.

See page 5.

- The Radiotext screen will be temporarily canceled when you operate the receiver.

It takes time to load data. While loading, “Loading” and progress indications appear.

- You can see approximate loading percentage with the indications.

If text message is unavailable, the text screen will change to source operation screen. Yet, when text message becomes available later, the text screen will automatically appear.

To show whole text at once, press and hold DISP while Radiotext is displayed.

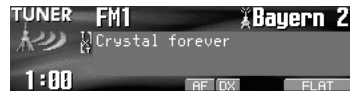

Multi-line text screen appears.

To restore the previous screen, press and hold DISP again.

Programme A broadcasting on different frequency areas (01 – 05)

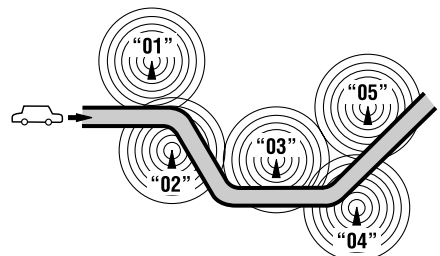

Disc/SD card operations

Playing a disc in the receiver



All tracks will be played repeatedly until you change the source or eject the disc.

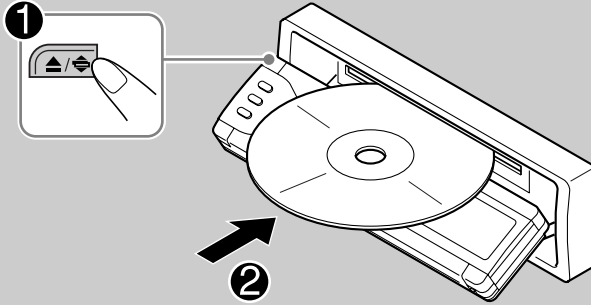

About MP3 and WMA discs

MP3 and WMA (Windows Media® Audio) “tracks” (words “file” and “track” are used interchangeably) are recorded in “folders.”

- When an MP3 or a WMA folder includes an image <jpw> file edited by Image Converter (Color Ver. 2.0)—supplied in the CD-ROM, you can show the image on the display while the tracks in the folder are played back—ImageLink. (See pages 36 and 52 for details.)

- When inserting an audio CD or a CD Text disc:

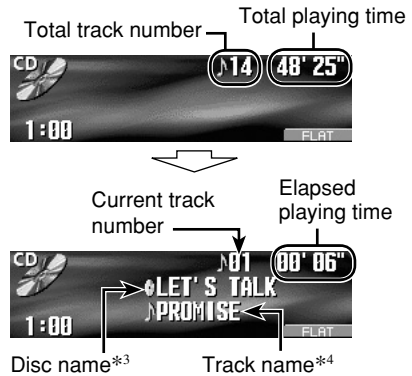

- *1 Either the MP3 or WMA indicator lights up depending on the detected file.
- *2 The album name/performer with indicator and the track title with indicator will appear if “Tag” is set to “On” (see page 38).
- *3 Appears only for CD Texts and CDs if it has been assigned or recorded. (“No Name” appears if no name is recorded or assigned to an audio CD.)
- *4 Appears only for CD Texts. (“No Name” appears if no name is recorded.)

- When inserting an MP3 or a WMA disc:

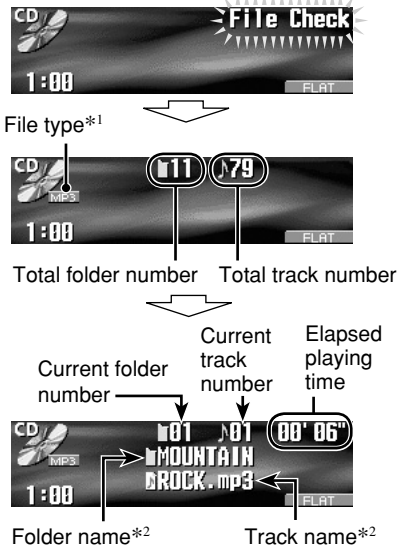

To stop play and eject the disc



To return the control panel to its previous position, press it again.

Playing discs in the CD changer

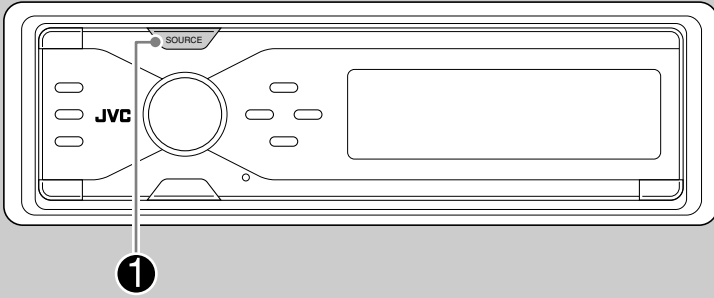

About the CD changer

It is recommended to use the JVC MP3-compatible CD changer with your receiver.

- You can also connect other CH-X series CD changers (except CH-X99 and CH-X100). However, they are not compatible with MP3 discs, so you cannot play back MP3 discs.
- You cannot use the KD-MK series CD changers with this receiver.
- Disc text information recorded in the CD Text can be displayed when a JVC CD Text compatible CD changer is connected.
- You cannot control and play any WMA disc in the CD changer.

All tracks of the inserted discs in the magazine will be played repeatedly until you change the source or eject the magazine from the CD changer.

1

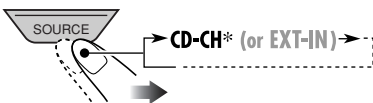

* If you have changed "Ext Input" setting to "Ext Input" (see page 39), you cannot select the CD changer.

- When the current disc is an MP3 disc:

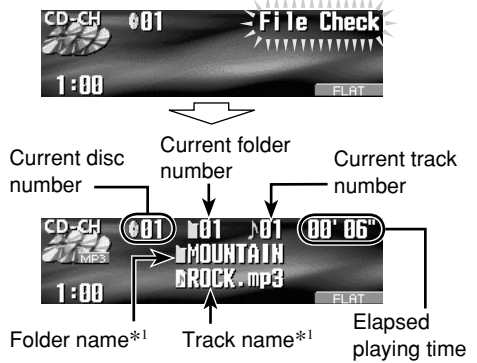

- When the current disc is an audio CD or a CD Text disc:

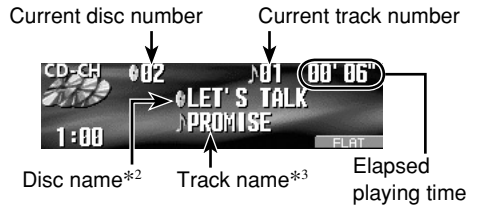

*1 The album name/performer with indicator and the track title with indicator will appear if "Tag" is set to "On" (see page 38).

*2 Appears only for CD Texts and CDs if it has been assigned or recorded. ("No Name" appears if no name is recorded or assigned to an audio CD.)

*3 Appears only for CD Texts. ("No Name" appears if no name is recorded.)

Playing an SD card

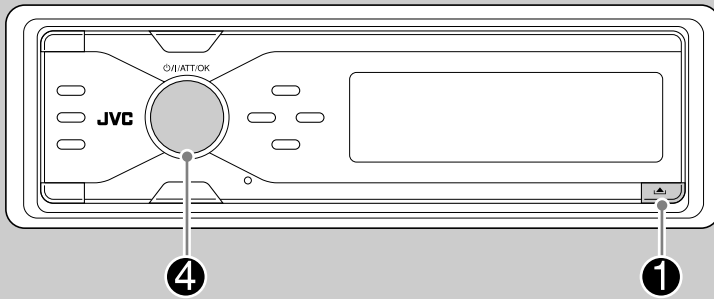

About the SD card

You can play back MP3/WMA tracks recorded on the SD card and show the stored image on the display during playback—ImageLink. (See pages 36 and 52 for details.)

The required SD recording format is FAT 12/16 and the recommended storage type is 8 MB to 512 MB.

- You cannot use MMC or mini SD with this receiver.

Before detaching the control panel, turn off the power.

1 Detach the control panel.

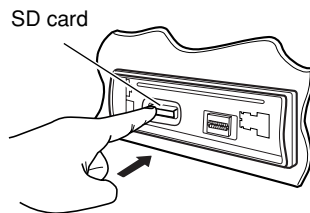
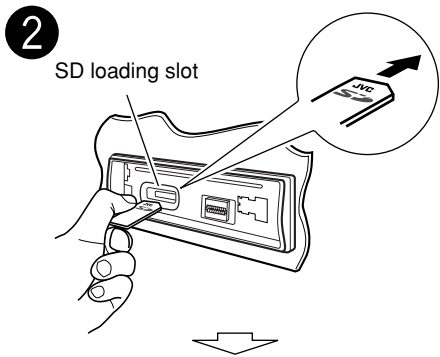
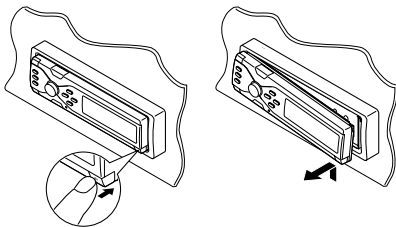

Press in the SD card until you hear a clicking sound.

To eject the SD card, press the SD card again.

- Press the SD card softly (do not release your finger quickly); otherwise the SD card may pop out from the unit.

To be continued....

3 Attach the control panel.

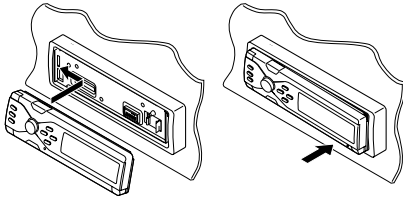

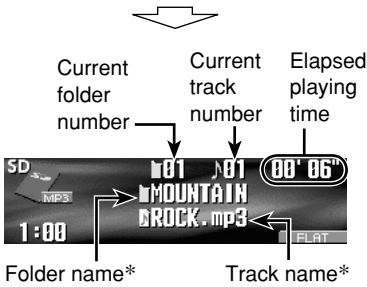
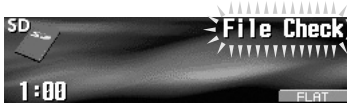

4  • The control panel goes back to the previous position (see page 42).

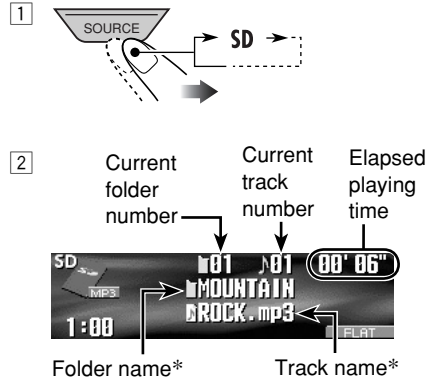

Playback starts automatically if tracks are recorded.

If an SD Card has been loaded...



* The album name/performer with  indicator and the track title with  indicator will appear if "Tag" is set to "On" (see page 38).

To fast-forward or reverse the track

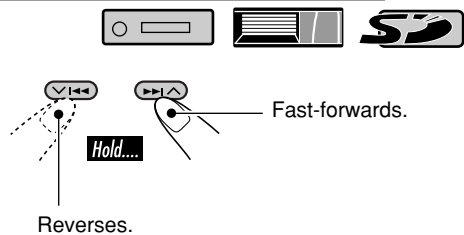

To go to the next or previous tracks

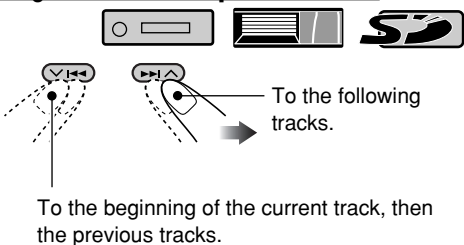

To go to the next or previous folders (only for MP3 and WMA tracks)

For MP3 tracks:



For WMA tracks:

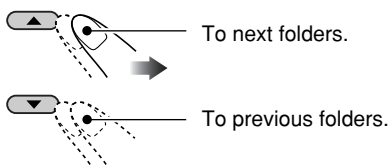

- Holding the buttons can display the Disc List () and Folder List (/) (see the following section).

Other main functions

Selecting a disc/folder/track on the list



- This function is not available for an audio CD or a CD text when the source is “CD.”

1 Enter the MODE menu (see page 5).

2 Select “List.”



3 Select the list type—“Disc,”*1 “Folder,”*2 or “File.”*2

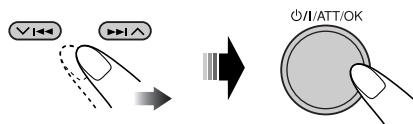

*1 Selectable only when the source is “CD-CH.”

*2 Appears only for MP3/WMA files.

1 When “Disc” is selected:



Disc List appears.

- You can move to the other list by pressing \leftarrow / \rightarrow (\wedge / \vee).

To select a disc



To be continued....

To start playback



- The Folder List of the selected disc appears in the following cases;
 - if the selected disc is an MP3 disc, and
 - if you select the current disc (highlighted on the screen).

2 When “Folder” is selected:



Folder List appears.

- You can move to the other lists by pressing $\left\langle \left\langle \right\rangle \right\rangle$ (\wedge / \vee).

To select a folder



To start playback



- If you select the current folder (highlighted on the screen), its File List appears.

3 When “File” is selected:



File List appears.

- You can move to the other lists by pressing $\left\langle \left\langle \right\rangle \right\rangle$ (\wedge / \vee).

To select a file



To start playback



When using the remote controller...



- To directly select a disc ()
- To directly select a track of an audio CD or a CD Text ()
- To directly select an MP3/WMA folder (/)

To select a number from 1 – 6:

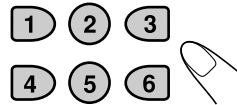

To select a number from 7 (1) – 12 (6):

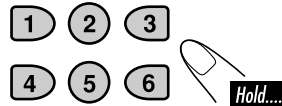

- For MP3/WMA folders:
It is required that folders are assigned with 2-digit number at the beginning of their folder names—01, 02, 03, and so on.

Prohibiting disc ejection



You can lock a disc in the loading slot.

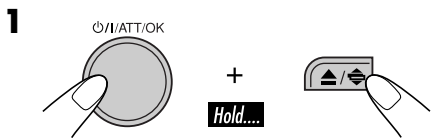

No Eject?
Emergency Eject?

- 2** After making sure “No Eject?” is selected (highlighted)...



“No Eject” flashes, and the disc cannot be ejected.

To cancel the prohibition

Repeat the same procedure, press P/I/ATT/OK in step **2** after making sure that “Eject OK?” is selected (highlighted).
“Eject OK” flashes.

Selecting the playback modes



You can use only one of the following playback modes at a time.

- 1** Enter the MODE menu (see page 5).

- 2** Select one of the playback modes—“Intro,” “Repeat,” or “Random.”



- 3** Select your desired playback modes.

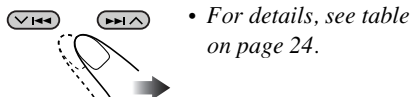

- 4** Finish the procedure.





To be continued....

Intro play



Ex.: When "Track Intro" is selected while playing an MP3 disc in the receiver

Mode Plays the beginning 15 seconds of...



- Track:** All tracks of the current disc or the SD card.
- While playing,  **INTRO** lights up.
- Folder*1:** First tracks of all folders of the current disc or the SD card.
- While playing,  **INTRO** lights up.
- Disc*2:** First tracks of all the inserted discs.
- While playing,  **INTRO** lights up.
- Off:** Cancels.

Repeat play

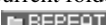

Ex.: When "Track Repeat" is selected while playing an MP3 disc in the receiver

Mode Plays repeatedly



- Track:** The current track.
- While playing,  **REPEAT** lights up.
- Folder*1:** All tracks of the current folder.
- While playing,  **REPEAT** lights up.
- Disc*2:** All tracks of the current disc.
- While playing,  **REPEAT** lights up.
- Off:** Cancels.





Random play

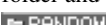
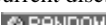
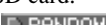

Ex.: When "Disc Random" is selected while playing an MP3 disc in the receiver

Mode Plays at random

- Folder*1:** All tracks of the current folder, then tracks of the next folder and so on.
- While playing,  **RANDOM** lights up.
- Disc:** All tracks of the current disc.
- While playing,  **RANDOM** lights up.
- SD:** All tracks of the SD card.
- While playing,  **RANDOM** lights up.
- All*2:** All tracks of the inserted discs.
- While playing,  **RANDOM** lights up.
- Off:** Cancels.

*1 Only while playing an MP3 ( /  / ) or a WMA ( / ) track.

*2 Only while playing a disc in the CD changer ().

Selecting the DSP modes—DSP

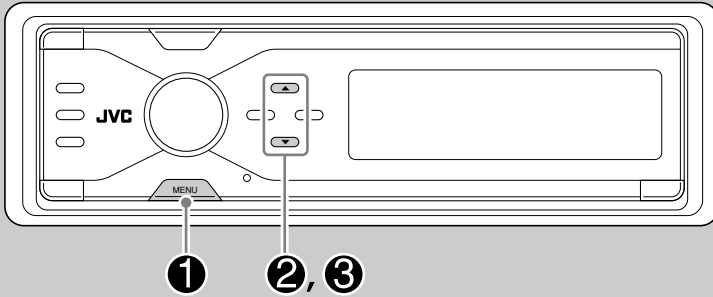

You can create a more acoustic sound field such as in a theater, hall, etc.

Available DSP modes

Defeat (No DSP mode is applied)
Theater, Hall, Club, Dome, Studio, V.Cancel (Voice Cancel: Reduces the vocal sounds. Good for mastering your favorite songs—Karaoke.)

3 Adjust the effect level (1 – 3).



The selected DSP effect level is valid for all DSP modes except “V.Cancel.”

- As the number increases, the effect level becomes stronger.

1 Enter the DSP menu (see page 5).

2 Select one of the DSP modes.



Ex.: When “Theater” is selected

- To finish the procedure

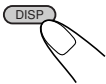

- To adjust the effect level

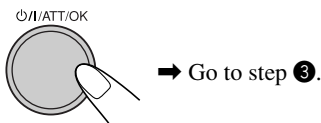

- To finish the procedure

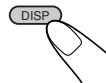

- To make further precise settings

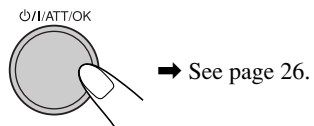

To cancel the DSP modes, select “Defeat” in step 2.

To be continued...

To make further precise settings for the DSP modes

These settings you make are valid for all DSP modes except “V.Cancel.”

Setting items:

The number of the built-in speakers:

Select the number of the speakers built in your car—“2ch” or “4ch.”

- When you have four speakers (4ch) built in your car, select your car size (see step 4 that follows).

Listening seat position:

Select the listening seat position where you want to locate the sound image.

- Repeat steps 1 to 3 on page 25 to select DSP mode (except “V.Cancel”).



- Select the number of the built-in speakers.

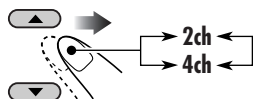

2ch: Select for the two speaker system.

4ch: Select for the four speaker system.

-
-
-



- If you select “2ch,” go to step 5.

- If you select “4ch,” select your car size.

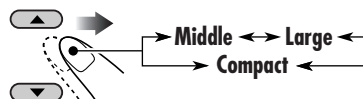

Middle: Select when the distance from the rear speakers to the listening seat position is almost equal to that from the front speakers.

Large: Select when the distance from the rear speakers to the listening seat position is longer than that from the front speakers.

Compact: Select when the distance from the rear speakers to the listening seat position is shorter than that from the front speakers.

- Select your listening seat position.



All: For all front and rear seats.

Front: For the both front seats.

R.Front: For the front right seat.

L.Front: For the front left seat.

- Finish the procedure.



Making sound natural

To activate Compression Compensative (CC) Converter

CC Converter eliminates jitter and ripples, achieving a drastic reduction in digital distortion. This processing can be applied to the analog sources as well as the digital sources; therefore, you can obtain a natural sound field from any source.

1 Enter the CCC menu (see page 5).

2 Select “On.”

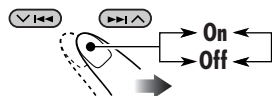

- When “C.C.Conv.” is turned on, the CCC indicator is brightened in yellow on the display.
- **To cancel CC Converter**, select “Off.”

3 Finish the procedure.



To activate BBE Digital

BBE Digital* is a digital processing method to restore the brilliance and clarity of the original live sound in recording, broadcasts, etc. When a speaker reproduces sound, it introduces frequency-dependent phase shifting, causing high-frequency sounds to take longer to reach the ear than low frequency sounds. BBE Digital adjusts the phase relationship between the low, mid and high frequencies by adding a progressively longer delay time to the low and mid frequencies, so that all frequencies reach the listener’s ears at the proper time.

1 Enter the BBE menu (see page 5).

2 Select the effect level.

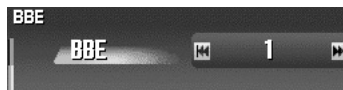

Ex.: When “1” is selected

- As the number gets higher, the effect level becomes stronger. When “BBE” is turned on, the BBE indicator is brightened in green (with its current level) on the display.
- **To cancel BBE Digital**, select “Off.”

3 Finish the procedure.



* **Manufactured under license from BBE Sound, Inc.**
 Licensed by BBE Sound, Inc. under
 USP4638258, 5510752 and 5736897. BBE and
 BBE symbol are registered trademarks of BBE
 Sound, Inc.

Setting the basic sound selection menu—SEL

You can adjust the sound characteristics to your preference.

1 Enter the SEL menu (see page 5).

2 Select a setting item—"Fad/Bal," "Subwoofer," or "VolAdjust."



Ex.: When "Fad/Bal" is selected

When selecting "Fad/Bal" and "Subwoofer," press **⏻/I/ATT/OK** to enter the selected menu.

3 Adjust the selected setting item.

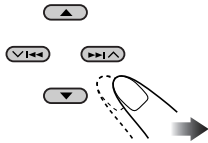

- To adjust other SEL settings, press **BACK**.

4 Finish the procedure.



To adjust fader and balance—Fad/Bal



Adjust the fader—speaker output balance between the front and rear speakers.

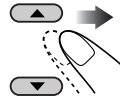

- Upmost—front only
- Downmost—rear only

Adjust the balance—speaker output balance between the left and right speakers.

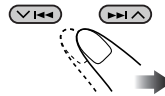

- Leftmost—left only
- Rightmost—right only

To adjust subwoofer output—Subwoofer



Select an appropriate cutoff frequency level according to the subwoofer connected.

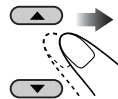

- 55Hz / 85Hz / 115Hz

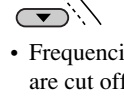

- Frequencies higher than the selected level are cut off to the subwoofer.

Adjust the subwoofer output level.

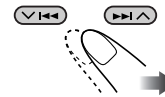

- 0 (min.) to 8 (max.)

To adjust the input level of each source—VolAdjust

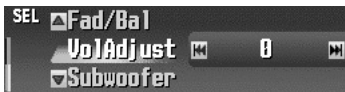

This setting is required for each source except FM. Before making an adjustment, select an appropriate source for which you want to make an adjustment.

Once you have made an adjustment, it is memorized, and the volume level will automatically increase or decrease by adjusted level whenever you change the source.

Adjust to match the input level to the FM sound level.

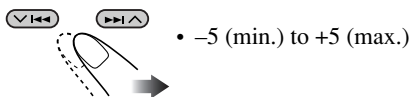

Selecting preset sound modes—EQ

You can select a preset sound mode suitable to the music genre.

Available sound modes

Flat (No sound mode is applied),
Hard Rock, R&B (Rhythm&Blues),
Pop, Jazz, Dance, Country, Reggae,
Classic, User 1, User 2, User 3

1 Enter the EQ menu (see page 5).

2 Select a sound mode.

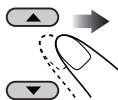

Ex.: When "Flat" is selected

3 Finish the procedure.

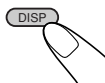

Storing your own sound modes

You can adjust the sound mode and store your own adjustments in memory.

1 Enter the EQ menu (see page 5).

2 Select a sound mode (see step 2 on page 29).

3 

4 Make adjustments as you like.

1 Select the frequency band — 60 Hz, 150 Hz, 400 Hz, 1 kHz, 2.4 kHz, 6 kHz, 12 kHz.



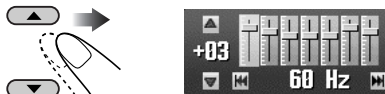

2 Adjust the level of the selected band within the range of -05 to +05.



3 Repeat steps 1 and 2 to adjust the other frequency bands.

5 Store the adjustments.

1  

2 Select one of the user modes— User 1/2/3.

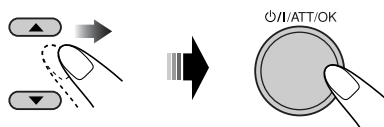

Ex.: When “User 1” is selected

The list below shows the preset frequency level settings for each sound mode:

Sound Mode	Preset equalizing values						
	60 Hz	150 Hz	400 Hz	1 kHz	2.4 kHz	6 kHz	12 kHz
Flat	00	00	00	00	00	00	00
Hard Rock	+03	+03	+01	00	00	+02	+01
R&B	+03	+02	+02	00	+01	+01	+03
Pop	00	+02	00	00	+01	+01	+02
Jazz	+03	+02	+01	+01	+01	+03	+02
Dance	+04	+02	00	-02	-01	+01	+01
Country	+02	+01	00	00	00	+01	+02
Reggae	+03	00	00	+01	+02	+02	+03
Classic	+02	+03	+01	00	00	+02	00
User 1	00	00	00	00	00	00	00
User 2	00	00	00	00	00	00	00
User 3	00	00	00	00	00	00	00

Basic procedure

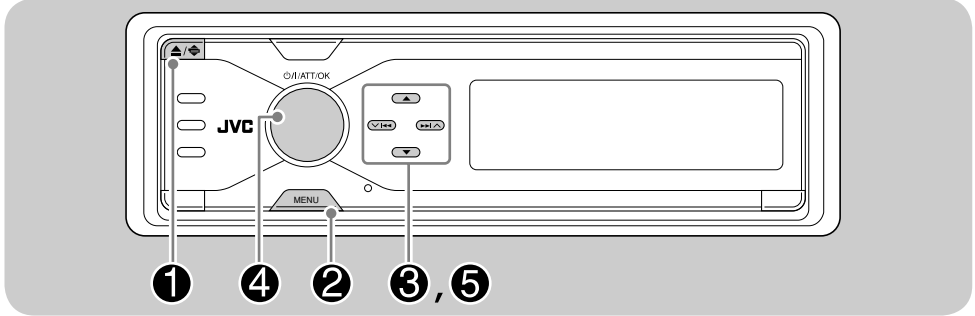

Before starting the following procedure, prepare a CD-R or an SD card including still images (pictures) and animations (movies).

- With Image Converter (Color Ver. 2.0) included in the supplied CD-ROM, you can create your own images and animations. (Samples are included in the CD-ROM.)
- You can store two sizes of picture and animation—“Large” and “Small” as the graphic display (see page 5).

1 Insert a CD-R, an SD card, or the supplied CD-ROM.

- CD-R/supplied CD-ROM

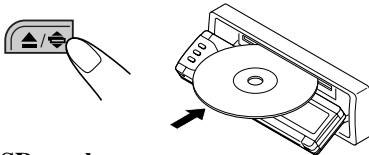

- SD card

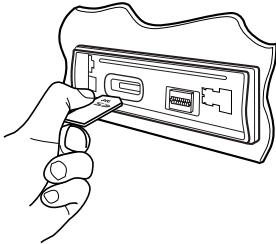

2 Enter the PICT menu (see page 5).

- If you press PICT, you can enter the PICT menu directly.

3 Select the picture size—“Large” or “Small.”

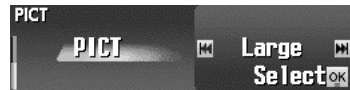
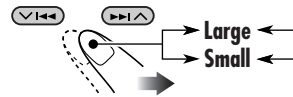

4 Press the PICT button.



5 Select the item.



Ex.: When “Delete” is selected

- To download the file(s):
➔ “Download” (see page 32)
- To delete the file(s):
➔ “Delete” (see page 33)
- To delete all files:
➔ “AllDelete” (see page 34)
- To activate the file(s):
➔ Activating the downloaded files (see page 35)

IMPORTANT:

- Refer also to Image Converter PDF files included in the “Manual” folder on the supplied CD-ROM.
- Still images (pictures) and animations (movie) should have the following extension code in their file names:
 - **.jpl**: for large size still images
 - **.jpm**: for small size still images
 - **.jpa**: for large size animations
 - **.jpb**: for small size animations
 - **.jpw**: for ImageLink (see pages 36 and 52)
- Before you download or delete the files, observe the following:
 - Do not download a file while driving.
 - Do not turn off the ignition key of the car while downloading or deleting a file.*
 - Do not detach the control panel while downloading or deleting a file.*

* If you do so, the file download or deletion will not be done correctly.

Downloading the files

- **Picture:** Graphic screen
To download/delete still images (16 still images each for large size and for small size) which will be shown while playing a source.
- **Movie:** Graphic screen
To download/delete animations (60 frames each for large size and for small size) which will be shown while playing a source.

■ Downloading pictures or animations

- It takes a long time to download an animation. For details, see page 53.
- To activate the downloaded files, see page 35.

1 Follow steps ① to ⑤ on page 31.

- In step ③, select the picture size.
- Then in step ⑤, select “Download.”

2 Select the file type—either “Picture” or “Movie.”

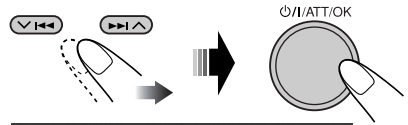

The Folder List appears.

3 Select a folder.

- You can move to the other lists by pressing ◀/▶/▶/▶ (V/^).

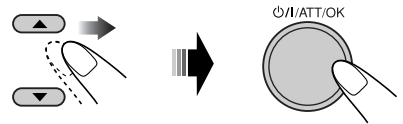

The File List appears.

4 Select a file.

- You can move to the other lists by pressing ◀/▶/▶/▶ (V/^).

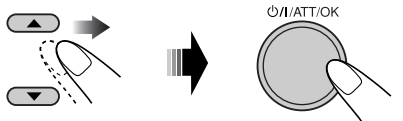

5 Download the file.



- To cancel downloading, press DISP.
- When download is complete, the File List appears again.

6 • To download more pictures from the same folder, repeat steps 4 and 5.

- To download more pictures from another folder, press BACK. Then, repeat steps 3 to 5.

7 Finish the procedure.

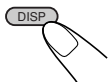

Deleting the files

Deleting the stored pictures and animations

1 Follow steps 1 to 5 on page 31.

- In step 3, select the picture size.
- Then in step 5, select “Delete.”

2 Select the file type—either “Picture” or “Movie.”

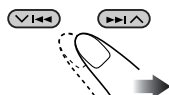

Ex.: When “Picture” is selected

3 • To delete the stored pictures



2 Select “Delete.”

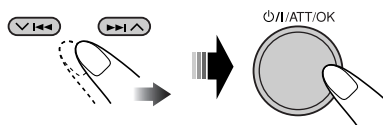

The File List appears.

3 Select a file.

- You can move the other lists by pressing \leftarrow/\rightarrow (\checkmark/\wedge).

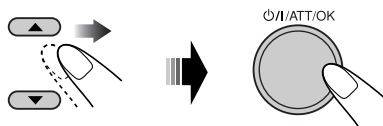

4



- When a file is deleted, the File List appears again.

5 Repeat steps 3 and 4 to delete more pictures.

To be continued...

• To delete the stored animation

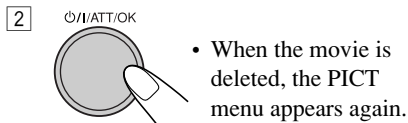

4 Finish the procedure.

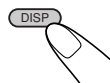

■ Deleting all the stored pictures and animations for each size

To delete all the stored pictures

You can delete all stored pictures of each size (“Large” or “Small”).

- 1 Follow steps 1 to 5 on page 31.
 - In step 3, select the picture size.
 - Then in step 5, select “Delete.”

2 Select “Picture.”

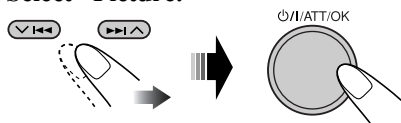

3 Select “AllDelete.”

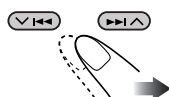

4 ϕ /I/ATT/OK

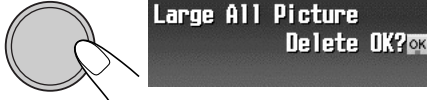

5 ϕ /I/ATT/OK

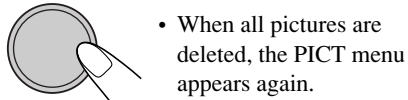

6 Finish the procedure.

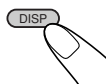

To delete all the stored files

You can delete all stored pictures and animations of each size (“Large” or “Small”).

- 1 Follow steps 1 to 5 on page 31.
 - In step 3, select the picture size.
 - Then in step 5, select “AllDelete.”

2 ϕ /I/ATT/OK

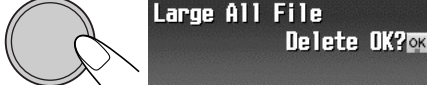

3 ϕ /I/ATT/OK

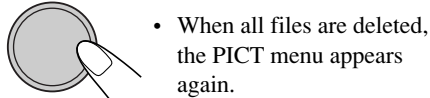

4 Finish the procedure.

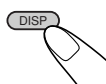

Activating the downloaded files

1 Enter the PSM menu (see page 5).

2 Select “PICT.”



3 Select the picture size you want to activate—“Large” or “Small.”

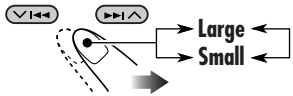

4 ϕ /I/ATT/OK



* If there is no still images or animation downloaded, you can only select “Default.”

5

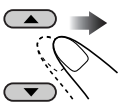

Picture: One of your edited still images stored in “Picture” is activated.
 ➔ Go to step **6**.

Slideshow: All stored still images are activated and shown in sequence (UserSlide).
 ➔ Go to step **7**.

Movie: Your edited animation stored in “Movie” is activated.
 ➔ Go to step **6**.

6 Select a file.

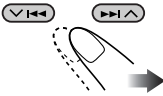

- For “Movie,” select either “Default” or “UserMovie.” (If no animation is stored, you can only select “Default.”)

7 Finish the procedure.



- To activate the file for the other size, repeat steps **1** to **7**.

General settings — PSM

Basic procedure

You can change PSM (Preferred Setting Mode) items listed in the table that follows.

1 Enter the PSM menu (see page 5).

2 Select a PSM item.

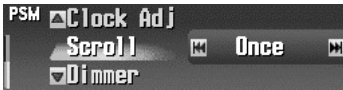
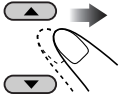

Ex.: When “Scroll” is selected

3 Adjust the setting.

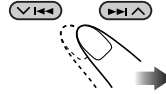

4 Repeat steps 2 and 3 to adjust the other PSM items if necessary.

5 Finish the procedure.



Indications

Selectable settings, [reference page]

Demo/Link

Display demonstration

Demo: [Initial]; Display demonstration (animation) appears.
ImageLink: To show a still image while playing back an MP3/WMA track, [17, 19, 52].
Off: Cancels.
 • These graphics appear if no operation is done for about 45 seconds.

WallPaper

Wall paper

You can select the background screen of the display window.
Standard 1 [Initial] **Standard 2** **Standard 3**
 ⌂ (back to the beginning)

LevelMeter

Audio level meter

You can select the level meter.
Meter1 [Initial] **Meter2** **Meter3** ⌂ (back to the beginning)
 • Press DISP repeatedly to show the selected level meter.

PICT

Pictures

You can activate the graphic screen using either movie or picture, [35].
 Select the picture size first.
Large: [Initial]; 256 x 64 pixel (full screen size)
Small: 64 x 64 pixel (CD jacket image)

After select the picture size, you can select one of the following items separately for “Large” and “Small.”

Picture: [Initial]; One of your edited still images stored in “Picture” is activated.
Slideshow: All stored still images are activated and shown in sequence (UserSlide).
Movie: Your edited animation stored in “Movie” is activated.
 • Press DISP repeatedly to show the selected graphics.

Indications	Selectable settings, [reference page]
Clock Hr Clock hour	0 – 23 (1 – 12), [9] [Initial: 0 (0:00)]
Clock Min Clock minute	00 – 59, [9] [Initial: 00 (0:00)]
24H/12H Clock system	12H (Hours) ⇄ 24H (Hours), [9] [Initial: 24H]
Clock Adj Automatic clock adjustment	Auto: [Initial]; The built-in clock is automatically adjusted using the CT (clock time) data in the RDS signal. Off: Cancels.
Scroll Scroll mode	Once: [Initial]; <u>For disc information:</u> scrolls the disc information only once. <u>For RDS Radiotext:</u> scrolls the text message continuously. <u>For DAB text:</u> scrolls the detailed DAB text. Auto: <u>For disc information:</u> repeats the scroll (in 5-second intervals). <u>For RDS Radiotext:</u> scrolls the text message continuously. <u>For DAB text:</u> scrolls the detailed DAB text. Off: <u>For disc information:</u> cancels. <u>For RDS Radiotext:</u> shows only the first page of the text message. <u>For DAB text:</u> shows only headline if any. • Holding DISP for more than one second can scroll the disc information regardless of the setting.
Dimmer Dimmer mode	Auto: [Initial]; Dims the display when you turn on the headlights. Time Set: Sets the timer for dimmer, [40]. Off: Cancels. On: Activates dimmer.
From-To* Dimmer time	Any hour – Any hour, [40] [Initial: 18:00 – 7:00]

* Displayed only when “Dimmer” is set to “Time Set.”

To be continued...

Indications	Selectable settings, [reference page]
Bright Brightness	1 – 8: Adjust the display brightness to make the display indications clear and legible. <i>[Initial: 8]</i>
Tag Tag display	On: <i>[Initial]</i> ; To show the ID3 tag display while playing MP3/WMA tracks, [17, 18, 20]. Off: Cancels.
PTyStandby PTY Standby	You can select one of the PTY codes for the PTY Standby Reception, [15]. <i>[Initial: News]</i>
AF-Regn'l Alternate frequency/ Regionalization reception	When the received signals from the current station become weak... AF: <i>[Initial]</i> ; Switches to another station (the programme may differ from the one currently received), [16]. • The AF indicator lights up. AF Reg: Switches to another station broadcasting the same programme. • The REG indicator lights up. Off: Cancels (not selectable when “DAB AF” is set to “On”).
TA Volume Traffic announcement volume	When a traffic programme (TA) is received, the volume level automatically changes to the preset level. <i>[Initial: 20]; 0 – 30 or 0 – 50*¹</i>
P-Search Programme search	On: The receiver tunes in to another frequency broadcasting the same programme as the original preset RDS station is if the preset station signals are not sufficient. Off: <i>[Initial]</i> ; Cancels.
IF Filter Intermediate frequency filter	Auto: <i>[Initial]</i> ; Increases the tuner selectivity to reduce interference noises between the stations. (Stereo effect will be lost.) Wide: Subject to the interference noises from adjacent stations, but sound quality will not be degraded. (Stereo effect will not be lost.)

Indications	Selectable settings, [reference page]
DAB AF * ² Alternative Frequency Reception	On: [Initial]; Traces the programme among DAB services and FM RDS stations, [48]. • The AF indicator lights up. Off: Cancels.
Announce * ² Announcement Standby Reception	Select one of the 9 announcement types for Announcement Standby Reception. Travel [Initial] ⇄ Warning ⇄ News ⇄ Weather ⇄ Event ⇄ Special ⇄ Rad Inf (Radio Information) ⇄ Sports ⇄ Finance ⇄ (back to the beginning)
Ext Input * ³ External input	Changer: [Initial]; To use a JVC CD changer, [18]. Ext Input: To use any external component other than above, [43].
Beep Key-touch tone	On: [Initial]; Activates the key-touch tone. Off: Deactivates the key-touch tone.
Telephone Telephone muting	Muting1/Muting2: Select either one which mutes the sounds while using the cellular phone. Off: [Initial]; Cancels. • If CD or CD changer has been selected as the source, playback pauses during telephone muting.
Amp Gain Amplifier gain control	You can change the maximum volume level of this receiver. HighPower: [Initial]; Volume 00 – Volume 50 Low Power: Volume 00 – Volume 30 (Select this if the maximum power of the speaker is less than 52 W to avoid damaging the speakers.) Off: Deactivates the built-in amplifier.

*¹ Depends on the amplifier gain control.

*² Displayed only when the DAB tuner is connected.

*³ Cannot be selected if the source is "CD-CH" or "EXT-IN."

Selecting the dimmer mode

You can dim the display at night or as you set the timer.

1 Enter the PSM menu (see page 5).

2 Select “Dimmer.”

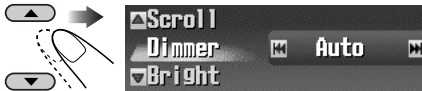

3 Select a setting.

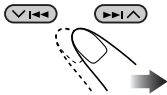

Auto: Dims the display when you turn on the headlights.
 ➔ Go to step **6**.

Time Set: Sets the timer for dimmer.
 ➔ Go to step **4**.

Off: Cancels.
 ➔ Go to step **6**.

On: Always dims the display.
 ➔ Go to step **6**.

4 Enter the Time Set screen.



5 Adjust the dimmer time.

1 Set the dimmer start time.

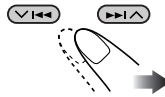

2 Set the dimmer end time.

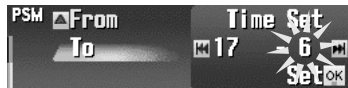
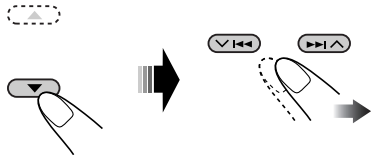

6 Finish the procedure.



Other main functions

Assigning titles to the sources

You can assign titles to CDs (both in this receiver and in the CD changer) and the external components (LINE-IN and EXT-IN).

Sources	Maximum number of characters
CDs/CD-CH*	Up to 32 characters (up to 30 discs)
External components	Up to 16 characters

* You cannot assign a title to a CD Text or an MP3/WMA disc.

1 Select the source.

- For a CD in this receiver: Insert a CD.
- For CDs in the CD changer: Select “CD-CH,” then select a disc number.
- For external components: Select “EXT-IN” or “LINE-IN” (see page 43).

2 Enter the TITLE menu (see page 5).

3 Assign a title.

1 Select a character set.

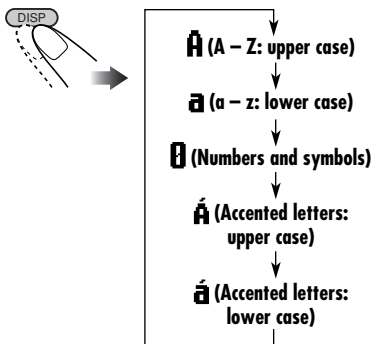

Ex.: When you assign a title to a CD

2 Select a character.

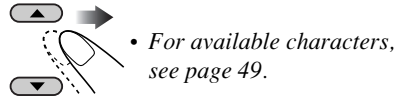

3 Move to the next (or previous) character position.

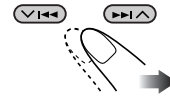

4 Repeat steps 1 to 3 until you finish entering the title.

4 Finish the procedure.



- To cancel the title entry without registration, press **MENU**.

To erase the entire title

In step 3 on the left...



Changing the control panel angle



The control panel changes its angle as follows:

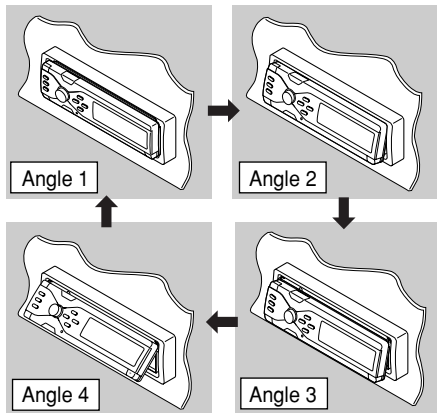

When using the remote controller...

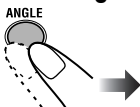

Caution:

Do not insert your finger behind the control panel.

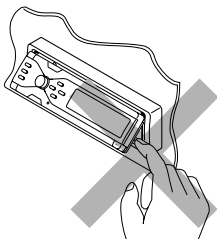

Detaching the control panel

When detaching or attaching the control panel, be careful not to damage the connectors on the back of the control panel and on the panel holder.

■ Detaching the control panel

Before detaching the control panel, be sure to turn off the power.

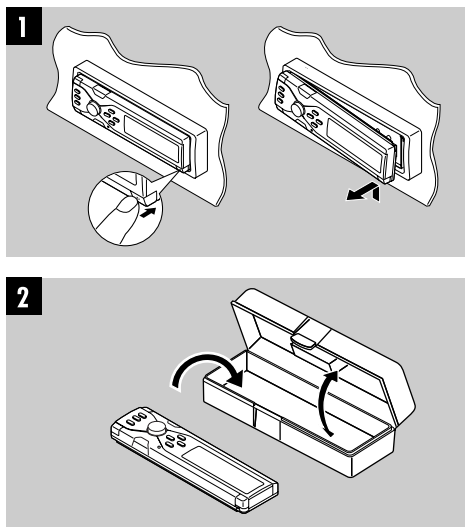

■ Attaching the control panel

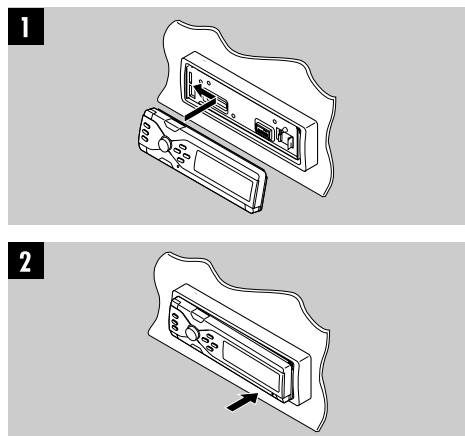

Playing an external component

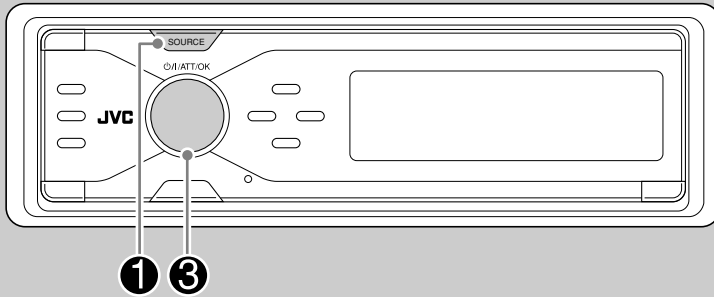

You can connect an external component to the LINE IN plugs on the rear.

You can also connect an external component to the CD changer jack on the rear using the Line Input Adapter KS-U57 (optionally purchased) or Aux Input Adapter KS-U58 (optionally purchased).

Before operating the external component, select the external input correctly (see page 39).

- For connection, see Installation/Connection Manual (separate volume).

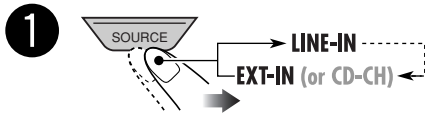

LINE-IN: For selecting the external component connected to the LINE IN plugs.



EXT-IN: For selecting the external component connected to the CD changer jack.

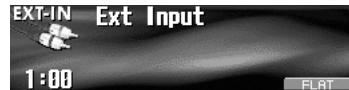

- If you have changed the “Ext Input” setting to “Changer” (see page 39), you cannot select “EXT-IN.”

2 Turn on the connected component and start playing the source.

3 Adjust the volume.



4 Adjust the sound as you want. (See pages 25 – 30.)

DAB tuner operations

Listening to the DAB tuner

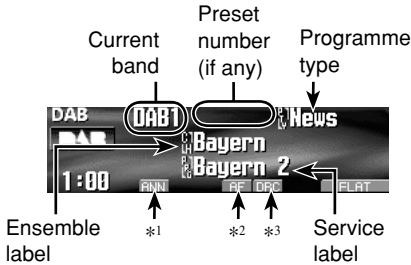
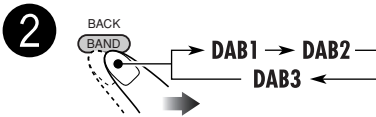
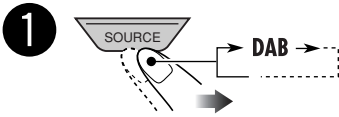
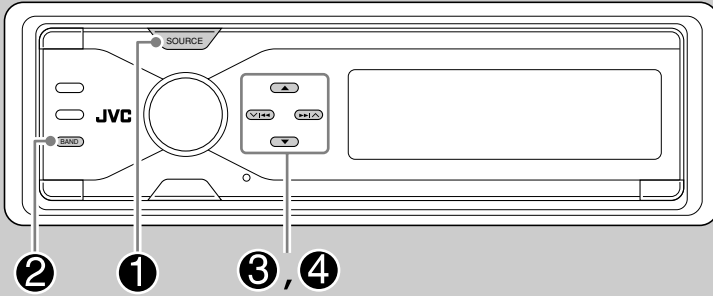

*1 ANN indicator: See page 47.
 *2 AF indicator: See page 39.
 *3 DRC indicator: See page 45.



When an ensemble is received, searching stops.
To stop searching, press the same button again.

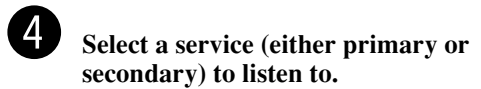

To tune in to an ensemble manually

In step **3** on the left...



Activate "Manual Search"

Select ensemble frequencies

What is DAB system?

DAB can deliver CD quality sound without any annoying interference and signal distortion. Furthermore, it can carry text, pictures, and data. When transmitting, DAB combines several programmes (called “services”) to form one “ensemble.” In addition, each “service”—called “primary service”—can also be divided into its components (called “secondary service”). A typical ensemble has six or more programmes (services) broadcast at the same time.

By connecting the DAB tuner, this receiver can do the following:

- Tracing the same programme automatically —Alternative Reception (see “DAB AF” on page 39).

It is recommended to use DAB (Digital Audio Broadcasting) tuner KT-DB1000 with your receiver. If you have another DAB tuner, consult your JVC IN-CAR ENTERTAINMENT dealer.

- Refer also to the Instructions supplied for your DAB tuner.

- 3 Select one of the DRC signal levels (1, 2, or 3).

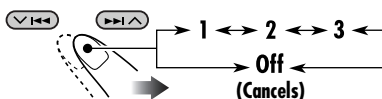

The reinforcement level increases from 1 to 3.

- 4 Finish the procedure.



DRC indicator appears.

- The DRC indicator will be highlighted only when receiving DRC signals from the tuned service.

When surrounding sounds are noisy

Some service provides Dynamic Range Control (DRC) signals together with their regular programme signals. DRC will reinforce the low level sounds to improve for your listening.

- 1 Enter the MODE menu (see page 5).

- 2 Select “DRC.”



To search for your favorite service

You can search for either Dynamic or Static PTY codes.

- Operations are exactly the same as explained on pages 13 and 14 for FM RDS stations.
- You cannot store PTY codes separately for the DAB tuner and the FM tuner.
- Search will be performed on the DAB tuner only.

Storing DAB services in memory

You can preset six DAB services (primary) for each band.

Ex.: Storing an ensemble (primary service) into the preset number 1 of the DAB1 band.

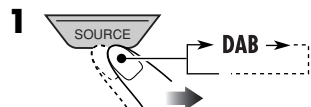

3 Select an ensemble (primary service).

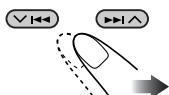

- By holding ▲/▼, the Preset Service List will also appear (see step 7 on the right column).

4 Enter the MODE menu (see page 5).

5 Select “List.”

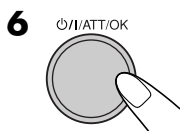

7 Select a preset number.

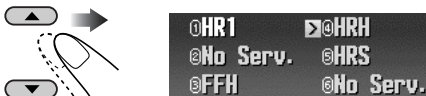

- If you press ◀▶/▶▶ (▼/▲), you can display the lists of the other DAB bands, but cannot store a service for the other bands.

8 Store the service.



When using the remote controller...

After tuning in to a service you want to preset

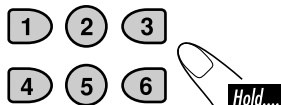

Tuning in to a preset DAB service

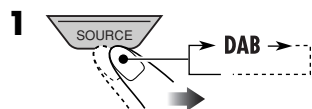

3 Perform steps 4 to 7 (on the left column) to enter the Preset Service List.



When using the remote controller...

To directly select the preset service

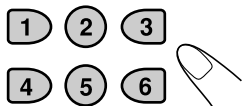

To activate the Announcement Standby Reception

1 Enter the MODE menu (see page 5).

2 Select “Announce.”

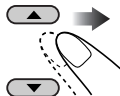

3 Select an announce type.

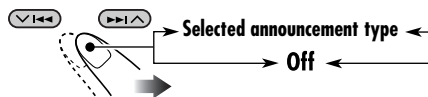

4 Finish the procedure.



ANN indicator appears.

- If the ANN indicator lights up, Announcement Standby Reception is activated.
- If the ANN indicator flashes, Announcement Standby Reception is not yet activated. To activate, tune in to another service providing these signals. The ANN indicator will stop flashing and remain lit.

To deactivate the Announcement Standby Reception

Select “Off” in step **3** above. The ANN indicator goes off.

Using the Standby Receptions

TA (Road Traffic News) Standby Reception

- Operations are exactly the same as explained on page 15 for FM RDS stations.
- You cannot activate TA Standby Reception separately for the DAB tuner and for FM tuner.

PTY Standby Reception

- Operations are exactly the same as explained on page 15 for FM RDS stations.
- PTY Standby Reception for DAB tuner works only using a dynamic PTY code.
- You can neither store your favorite PTY nor activate PTY Standby Reception separately for the DAB tuner and for the FM tuner.
- You can activate and deactivate PTY Standby Reception when the source is either “FM” or “DAB.”

Announcement Standby Reception

Announcement Standby Reception allows the receiver to switch temporarily to your favorite service (announcement type).

To select your favorite announcement type, see page 39.

Tracing the same programme— Alternative Frequency Reception

You can keep listening to the same programme by activating the Alternative Frequency Reception.

- **While receiving a DAB service:**

When driving in an area where a DAB service cannot be received, this receiver automatically tunes in to another ensemble or FM RDS station, broadcasting the same programme.

- **While receiving an FM RDS station:**

When driving in an area where a DAB service is broadcasting the same programme as the FM RDS station is broadcasting, this receiver automatically tunes in to the DAB service.

When shipped from the factory, Alternative Frequency Reception is activated.

To deactivate the Alternative Frequency Reception, see page 38.

To show the Dynamic Label Segment (DLS) information

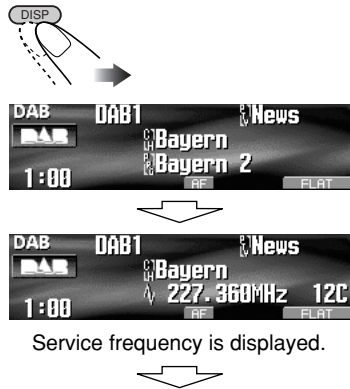

While listening to an ensemble that supports DLS...



Dynamic Label Segment (DLS—DAB radio text information) is displayed.

* *Lights up when receiving a service providing DLS.*

- The DLS screen will be temporarily canceled when you operate the receiver.

To show whole text at once, press and hold DISP while DLS is displayed.



Multi-line text screen appears.

- When the text contains more than 96 characters, another window appears to show the rest of the text.

To restore the previous screen, press and hold DISP again.

How to clean the connectors

Frequent detachment will deteriorate the connectors.

To minimize this possibility, periodically wipe the connectors with a cotton swab or cloth moistened with alcohol, being careful not to damage the connectors.

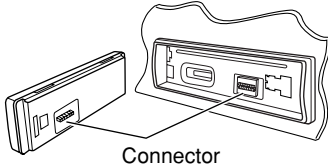

Moisture condensation

Moisture may condense on the lens inside the CD player in the following cases:

- After starting the heater in the car.
- If it becomes very humid inside the car.

Should this occur, the CD player may malfunction. In this case, eject the disc and leave the receiver turned on for a few hours until the moisture evaporates.

How to handle discs

When removing a disc from its case, press down the center holder of the case and lift the disc out, holding it by the edges.

Center holder



- Always hold the disc by the edges. Do not touch its recording surface.

When storing a disc into its case, gently insert the disc around the center holder (with the printed surface facing up).

- Make sure to store discs into the cases after use.

To keep discs clean

A dirty disc may not play correctly. If a disc does become dirty, wipe it with a soft cloth in a straight line from center to edge.



- Do not use any solvent (for example, conventional record cleaner, spray, thinner, benzene, etc.) to clean discs.

To play new discs

New discs may have some rough spots around the inner and outer edges. If such a disc is used, this receiver may reject the disc.



To remove these rough spots, rub the edges with a pencil or ball-point pen, etc.

How to handle SD card

SD cards are precision products. DO NOT impact, bend, drop, or wet them.

Available character

In addition to the Roman alphabets (A – Z, a – z), the following characters will be used.

- You can also use the following characters to assign titles (see page 41).

Accented letters: upper case

Á	À	Â	Ä	Å	Æ	Œ	Č	Ć	Ç	É	È	Ê
Ë	Ĝ	Í	Ì	Î	Ñ	Ó	Ô	Õ	Ø	Ř		
Š	Ś	Ş	Ú	Û	Ü	Ý	Ž	Ẓ	Ẕ	ẖ	ẘ	ẚ
Đ	Ƨ	Ł	ı	U	đ	space						

Accented letters: lower case

á	à	â	ä	å	æ	œ	č	ć	ç	é	è	ê
ë	ğ	í	ì	î	ñ	ń	ó	ô	õ	ø		
š	ś	ş	ú	û	ü	ý	ž	ẓ	ẕ	ẘ	ẚ	ẛ
đ	Ƨ	ł	ı	u	đ	space						

Numbers and symbols

0	1	2	3	4	5	6	7	8	9	!	"	#	\$
%	&	'	()	*	+	-	.	/	:	;	<	
=	>	?	@	_	`	ı	¿	£	€	α	space		

Do not use the following discs:

Warped disc



Sticker



Sticker residue

Disc



Stick-on label

More about this receiver

Basic operations

Turning on the power

- By pressing SOURCE on the receiver, you can also turn on the power.

Turning off the power

- If you turn off the power while listening to a disc, disc play will start from where playback has been stopped previously, next time you turn on the power.

Selecting the source

- When no disc or SD card is loaded in the receiver, “CD” or “SD” cannot be selected.
- Without connecting to the CD changer or DAB tuner, “CD-CH” or “DAB” cannot be selected.
- To select the “EXT-IN” for the playback source, set the “Ext Input” setting correctly (see page 39).

Tuner operations

Storing stations in memory

- During SSM search...
 - All previously stored stations are erased and stations are stored newly.
 - Received stations are preset in No. 1 (lowest frequency) to No. 6 (highest frequency).
 - When SSM is over, the station stored in No. 1 will be automatically tuned in.
- When storing a station manually, a previously preset station is erased when a new station is stored in the same preset number.

FM RDS operations

- Network-Tracking Reception requires two types of RDS signals—PI (Programme Identification) and AF (Alternative Frequency) to work correctly. Without receiving these data correctly, Network-Tracking Reception will not operate.

- If a DAB tuner is connected and Alternative Frequency Reception for DAB services (DAB AF) is activated, Network-Tracking Reception (AF-Regn'l) is also activated automatically. On the other hand, Network-Tracking Reception cannot be deactivated without deactivating Alternative Frequency Reception. (See pages 38 and 39.)
- TA Standby Reception and PTY Standby Reception will be temporarily canceled while listening to an AM station.
- Message service requires the RDS Radiotext signal. It is available on most major stations. If reception is weak, the service may become unavailable. For any questions regarding the content of this service, please contact your broadcaster.
- If you want to know more about RDS, visit <<http://www.rds.org.uk>>.

Disc/SD card operations

Caution for DualDisc playback

- The Non-DVD side of a “DualDisc” does not comply with the “Compact Disc Digital Audio” standard. Therefore, the use of Non-DVD side of a DualDisc on this product may not be recommended.

General

- This receiver has been designed to reproduce CDs/CD Texts, and CD-Rs (Recordable)/CD-RWs (Rewritable) in audio CD (CD-DA), MP3 and WMA format and MP3/WMA files recorded in an SD card.
- When a disc or an SD card has been loaded, selecting “CD” or “SD” for the playback source starts playback.

Inserting a disc

- When a disc is inserted upside down, the control panel moves down, and the disc automatically ejects from the loading slot.
- If you keep the control panel open for about 1 minute, (beeps sound when the “Beep” setting is turned “On”—see page 39) the control panel returns to its previous position.

Playing a disc/SD card

- While playing an audio CD: If a title has been assigned to the audio CD (see page 41), it will be shown on the display.
- While fast-forwarding or reversing an MP3 or WMA track, you can only hear intermittent sounds.
- While playing an SD card, the playback order may differ from the one played back using other SD players.
- This receiver may be unable to play back some SD card due to their characteristics or recording conditions.
- This receiver cannot play back mini SD card and MMC.
- If the inserted SD card does not have the correct files, you cannot select “SD” for the playback source.

Playing a CD-R or CD-RW

- Use only “finalized” CD-Rs or CD-RWs.
- This receiver can play back only the files of the same type which is first detected if a disc includes both audio CD (CD-DA) files and MP3/WMA files.
- This receiver can play back multi-session discs; however, unclosed sessions will be skipped while playing.
- Some CD-Rs or CD-RWs may not play back on this receiver because of their disc characteristics, and for the following causes:
 - Discs are dirty or scratched.
 - Moisture condensation occurs on the lens inside the receiver.
 - The pickup lens inside the receiver is dirty.
 - CD-R/CD-RW on which the files are written with “Packet Write” method.
 - Improper recording conditions (missing data, etc.) or media conditions (stain, scratch, warp, etc.).
- CD-RWs may require a longer readout time since the reflectance of CD-RWs is lower than that of regular CDs.

- Do not use the following CD-Rs or CD-RWs:
 - Discs with stickers, labels, or protective seal stuck to the surface.
 - Discs on which labels can be directly printed by an ink jet printer.
 Using these discs under high temperatures or high humidities may cause malfunctions or damages to discs.

Playing an MP3/WMA track

- This receiver can play back MP3/WMA files with the extension code <.mp3> or <.wma> (regardless of the letter case—upper/lower).
 - This receiver can show the names of albums, artists (performer), and ID3 Tag (Version 1.0, 1.1, 2.2, 2.3, or 2.4) for MP3 files and for WMA files.
 - This receiver can display only one-byte characters. No other characters can be correctly displayed (see page 49).
 - This receiver can play back MP3/WMA files meeting the conditions below:
 - Bit rate: 8 kbps — 320 kbps
 - Sampling frequency:
 - 48 kHz, 44.1 kHz, 32 kHz (for MPEG-1)
 - 24 kHz, 22.05 kHz, 16 kHz (for MPEG-2)
 - 48 kHz, 44.1 kHz, 32 kHz (for WMA)
 - Disc format: ISO 9660 Level 1/ Level 2, Romeo, Joliet, Windows long file name
 - For MP3/WMA discs:
 - The maximum number of characters for file/folder names vary among the disc format used (includes 4 extension characters—<.mp3> or <.wma>).
 - ISO 9660 Level 1: up to 12 characters
 - ISO 9660 Level 2: up to 31 characters
 - Romeo*: up to 128 (72) characters
 - Joliet*: up to 64 (36) characters
 - Windows long file name*: up to 128 (72) characters
- * *The parenthesis figure is the maximum number of characters for file/folder names in case the total number of files and folders is 313 or more.*

To be continued....

- For SD cards:
The maximum number of characters for folder name is 8 characters; file name is 12 characters.
The receiver cannot recognize folder with period (.) on the folder name.
- This receiver can recognize the total of 512 files, of 200 folders, and of 8 hierarchies of an MP3/WMA disc; 255 files and 63 folders of an SD card.
- This receiver can play back the files recorded in VBR (variable bit rate).
The files recorded in VBR have a discrepancy in elapsed time display, and do not show the actual elapsed time. Especially, after performing the search function, this difference becomes noticeable.
- This receiver cannot play back the following files:
 - MP3 files encoded with MP3i and MP3 PRO format.
 - MP3 files encoded in an unappropriated format.
 - MP3 files encoded with Layer 1/2.
 - WMA files encoded with lossless, professional, and voice format.
 - WMA files which are not based upon Windows Media® Audio.
 - WMA files copy-protected with DRM.
 - Files which have the data such as WAVE, ATRAC3, etc.
- The search function works but search speed is not constant.

Changing the source

- If you change the source, playback also stops (without ejecting the disc).
Next time you select “CD,” “SD,” or “CD-CH” for the playback source, playback starts from where it has been stopped previously.

ImageLink

- “Large” ImageLink screen will be temporarily changed to source operation screen when you operate the receiver.

- ImageLink will not work in the following cases:
 - If no <jpw> file is included in an MP3/WMA folder.
 - If Intro Scan is activated.
 - If the source is changed to another from “CD” or “SD.”
- If more than one <jpw> file are included in a folder, a file with the youngest file number is used for the graphic screen.

Ejecting a disc

- If the ejected disc is not removed within 15 seconds, the disc is automatically inserted again into the loading slot to prevent it from dust. (Disc will not play this time.)

Sound adjustment

Selecting the DSP modes—DSP

- Effectiveness of “V.Cancel” depends on the recording condition of the sources. Especially, if you play back the following sources you cannot get the satisfactory results.
 - Monaural sources such as AM and monaural FM broadcasting programs,
 - Multiplex sound sources, and
 - Sources recorded with duets, strong echo, a chorus, or only a few instruments.
- If “V.Cancel” is selected, CCC, BBE, and preset sound modes (EQ) will not be adjusted (“Fix” appears on the display.)
- When “4ch” is selected, rear speakers are used only to reproduce reflections and reverberations in order to creates a being-there feeling in your car compartment.
- If fader or balance has been set close to its extreme, appropriate effect may not be obtained.

Setting the basic sound selection menu—SEL

- If you are using a two-speaker system, set the fader level to the center.

- Subwoofer out setting takes effect only when a subwoofer is connected.
- You cannot change the input level—“VolAdjust” of the FM stations. If the source is FM, “Fix” will appear when you try to adjust it.

Storing your own sound modes

- If you do not want to store your current adjustment, but only to apply the adjustment to the current playback source, press MENU to go back to the operation screen of the current source. Adjustment you made remains effective until you select a sound mode.

Graphic displays

General

- You can display two sizes of pictures and animations (see page 5).
 - Large: <jpl> for the still pictures and <jpa> for the animations;
The image can be shown as the display background.
 - Small: <jpm> for the still pictures and <jpb> for the animations;
The image is displayed like a CD jacket (in the same proportion of CD jacket).

Downloading (or deleting) files

- You can download a file only while selecting “CD” or “SD” for the playback source; on the other hand, you can delete a file while selecting any source.
- If you have already downloaded an animation, downloading a new animation deletes the previously stored animation.
- It takes a long time to download files.
 - About 6 seconds for a still image (one frame).
 - About 6 minutes for an animation of 60 frames.
- If a disc inserted does not include any <jpl>, <jpm>, <jpa>, and <jpb> files, beeps sound when you try to operate the downloading procedure.

- If you try to store the 16th image for picture screen for each “Large” and “Small” size, “Picture Full” appears and you cannot start downloading. Delete unwanted files before downloading.

General settings—PSM

- To set the “PICT” setting as you like, download the required files before setting. If “Default” (for “Picture” and “Movie”) and “No Slide” (for “Slideshow”) cannot be changed to other options, required files have not been downloaded.
- “Auto Dimmer” may not work correctly on some vehicles, particularly on those having a control dial for dimming. In this case, change the “Dimmer” setting to any one other than “Auto.”
- If you change the “Amp Gain” setting from “HighPower” to “Low Power” while the volume level is set higher than “30,” the receiver automatically changes the volume level to “30.”

Other main functions

Assigning titles to the sources

- If you try to assign a title to the 31st disc, “Name Full” appears and you cannot enter the text entry mode. Delete unwanted titles before assignment.
- Titles assigned to discs in the CD changer can also be shown if you play back the disc in the receiver.

DAB tuner operations

- PTY Standby Reception works for the DAB tuner only using a Dynamic PTY, but not a Static PTY.
- TA Standby Reception for FM RDS station and Road Traffic News Standby Reception for DAB cannot be set separately. The T/P button always work for the both Standby Reception modes when the DAB tuner is connected.

Troubleshooting

What appears to be trouble is not always serious. Check the following points before calling a service center.

	Symptoms	Causes	Remedies
General	<ul style="list-style-type: none"> • Sound cannot be heard from the speakers. 	<p>The volume level is set to the minimum level.</p> <p>Connections are incorrect.</p>	<p>Adjust it to the optimum level.</p> <p>Check the cords and connections.</p>
	<ul style="list-style-type: none"> • The receiver does not work at all. 	<p>The built-in microcomputer may have functioned incorrectly due to noise, etc.</p>	<p>Reset the receiver (see page 2).</p>
	<ul style="list-style-type: none"> • “Connect Error” appears on the display. 	<p>The control panel is not attached correctly.</p>	<p>Remove the control panel, wipe the connector, then attach it again (see pages 42 and 49).</p>
	<ul style="list-style-type: none"> • “Push Reset” appears on the display and the control panel movement is frozen. 	<p>Something is blocking the control panel movement.</p>	<p>Reset the receiver (see page 2). If this does not work, check the installation.</p>
FM / AM	<ul style="list-style-type: none"> • SSM automatic presetting does not work. 	<p>Signals are too weak.</p>	<p>Store stations manually.</p>
	<ul style="list-style-type: none"> • Static noise while listening to the radio. 	<p>The aerial is not connected firmly.</p>	<p>Connect the aerial firmly.</p>
	<ul style="list-style-type: none"> • “No Text” appears on the display. 	<p>The station does not support RDS RT or the reception is weak.</p>	<p>Check the Network-Tracking Reception (see page 16).</p>
	<ul style="list-style-type: none"> • “Loading” does not disappear. 	<p>The receiving signal is temporarily too weak to receive a complete message although the service is available.</p>	<p>Check the Network-Tracking Reception (see page 16).</p>
Disc playback	<ul style="list-style-type: none"> • CD-R/CD-RW cannot be played back. • Tracks on the CD-R/CD-RW cannot be skipped. 	<p>CD-R/CD-RW is not finalized.</p>	<ul style="list-style-type: none"> • Insert a finalized CD-R/CD-RW. • Finalize the CD-R/CD-RW with the component which you used for recording.
	<ul style="list-style-type: none"> • Disc cannot be ejected. 	<p>Disc is locked.</p>	<p>Unlock the disc (see page 23).</p>
	<ul style="list-style-type: none"> • Disc cannot be recognized (“No Disc,” “Loading Error,” or “Eject Error” flashes). 	<p>The CD player may have functioned incorrectly.</p>	<p>Eject the disc forcibly (see page 4).</p>
	<ul style="list-style-type: none"> • Disc sound is sometimes interrupted. 	<p>You are driving on rough roads.</p>	<p>Stop playback while driving on rough roads.</p>
		<p>Disc is scratched.</p>	<p>Change the disc.</p>
	<p>Connections are incorrect.</p>	<p>Check the cords and connections.</p>	

Symptoms	Causes	Remedies
<ul style="list-style-type: none"> • “No Files” appears for a while, then the disc ejects. 	No MP3/WMA tracks are recorded.	Change the disc or the SD card.
	MP3/WMA tracks do not have the extension code <.mp3> or <.wma> in their file names.	Add the extension code <.mp3> or <.wma> to their file names.
	MP3/WMA tracks are not recorded in the format compliant with ISO 9660 Level 1, Level 2, Romeo, or Joliet.	Change the disc or the SD card. (Record MP3/WMA tracks using a compliant application.)
<ul style="list-style-type: none"> • Noise is generated. 	The track played back is not an MP3/WMA track (although it has the extension code <.mp3> or <.wma>).	Skip to another track or change the disc or the SD card. (Do not add the extension code <.mp3> or <.wma> to non-MP3 or WMA tracks.)
<ul style="list-style-type: none"> • Elapsed playing time is not correct. 	This sometimes occurs during play. This is caused by how the tracks are recorded.	_____
<ul style="list-style-type: none"> • “Not Support” appears on the display and track skips. 	<ul style="list-style-type: none"> • Tracks are not encoded in an appropriate format. • Copy-protected WMA tracks cannot be played back. 	Skip to the next track.
<ul style="list-style-type: none"> • “No Music” appears on the display. 	<ul style="list-style-type: none"> • No MP3/WMA tracks are recorded on the disc. • Only <.jpl>, <.jpm>, <.jpa>, <.jpb>, <.jpw> files are recorded on the disc. 	Change the disc or the SD card (formatted in FAT 12/16).
<ul style="list-style-type: none"> • “SD Loading Error” appears on the display. 	SD card is not inserted correctly.	Detach the control panel and reinsert the SD card. The control panel goes back to initial position (Angle 1): see page 42.
<ul style="list-style-type: none"> • “Read Failed” appears on the display. 	Tracks are not encoded in an appropriate format.	Use SD card formatted in FAT 12/16.
	The SD card or tracks cannot be played back.	Change the SD card.
<ul style="list-style-type: none"> • Correct characters are not displayed (ex. album name). 	This receiver can only display a limited number of special characters (see page 49).	_____

MP3/WMA disc/SD card playback

To be continued....

	Symptoms	Causes	Remedies
Sounds	<ul style="list-style-type: none"> • CCC, BBE, and preset sound modes (EQ) cannot be used. 	These sound adjustments cannot be performed when “V.Cancel” is selected for the DSP mode.	Select any mode other than “V.Cancel” for the DSP mode.
Graphics	<ul style="list-style-type: none"> • Download does not seem to finish. 	It takes quite a long time to download an animation of many frames (see page 53).	_____
PICT—PSM	<ul style="list-style-type: none"> • The display graphic function does not work correctly. 	Temperature in the car compartment is very low.	Wait until the operating temperature resumes.
	<ul style="list-style-type: none"> • You cannot activate “Slideshow” for “PICT” (“No Slide” is shown as the selectable item). 	No still images are downloaded yet.	Download a still image.
CD changer	<ul style="list-style-type: none"> • “No Magazine” flashes on the display. 	No magazine is loaded in the CD changer.	Insert the magazine.
	<ul style="list-style-type: none"> • “No Disc” flashes on the display. 	No disc is in the magazine.	Insert disc into the magazine.
		Disc is inserted upside down.	Insert disc correctly.
	<ul style="list-style-type: none"> • “Reset 08” flashes on the display. 	This receiver is not connected to the CD changer correctly.	Connect this receiver and the CD changer correctly and press the reset button of the CD changer.
	<ul style="list-style-type: none"> • “Reset 01” – “Reset 07” flashes on the display. 	The CD player may have functioned incorrectly.	Press the reset button of the CD changer.
<ul style="list-style-type: none"> • The CD changer does not work at all. 	The built-in microcomputer may function incorrectly due to noise, etc.	Reset the receiver (see page 2).	

Specifications

AUDIO AMPLIFIER SECTION

Maximum Power Output:

Front: 52 W per channel

Rear: 52 W per channel

Continuous Power Output (RMS):

Front: 22 W per channel into 4 Ω , 40 Hz to 20000 Hz at no more than 0.8% total harmonic distortion.

Rear: 22 W per channel into 4 Ω , 40 Hz to 20000 Hz at no more than 0.8% total harmonic distortion.

Load Impedance: 4 Ω (4 Ω to 8 Ω allowance)

Equalizer Control Range:

Frequencies: 60 Hz, 150 Hz, 400 Hz, 1 kHz, 2.4 kHz, 6 kHz, 12 kHz

Level: ± 10 dB

Frequency Response: 40 Hz to 20000 Hz

Signal-to-Noise Ratio: 70 dB

Line-In Level/Impedance:

LINE IN: 1.5 V/20 k Ω load

Line-Out Level/Impedance:

LINE OUT: 5.0 V/20 k Ω load (full scale)

Output Impedance: 1 k Ω

Other Terminals:

SUBWOOFER OUT

Changer control

Steering wheel remote input

TUNER SECTION

Frequency Range:

FM: 87.5 MHz to 108.0 MHz

AM: (MW) 522 kHz to 1 620 kHz

(LW) 144 kHz to 279 kHz

[FM Tuner]

Usable Sensitivity: 11.3 dBf (1.0 μ V/75 Ω)

50 dB Quieting Sensitivity: 16.3 dBf (1.8 μ V/75 Ω)

Alternate Channel Selectivity (400 kHz): 65 dB

Frequency Response: 40 Hz to 15000 Hz

Stereo Separation: 35 dB

Capture Ratio: 1.5 dB

[MW Tuner]

Sensitivity: 20 μ V

Selectivity: 65 dB

[LW Tuner]

Sensitivity: 50 μ V

CD/SD PLAYER SECTION

Type: Compact disc player

Signal Detection System: Non-contact optical pickup (semiconductor laser)

Number of Channels: 2 channels (stereo)

Frequency Response: 5 Hz to 20 000 Hz

Dynamic Range: 98 dB

Signal-to-Noise Ratio: 102 dB

Wow and Flutter: Less than measurable limit

MP3 (MPEG Audio Layer 3):

Max. Bit Rate: 320 kbps

WMA (Windows Media® Audio):

Max. Bit Rate: 192 kbps

Playable SD Card: Format: FAT 12/16

Storage: Up to 512 MB

Playable Audio Format for SD Card:

MP3/WMA

GENERAL

Power Requirement:

Operating Voltage:

DC 14.4 V (11 V to 16 V allowance)

Grounding System: Negative ground

Allowable Operating Temperature:

0°C to +40°C

Dimensions (W \times H \times D):

Installation Size (approx.):

182 mm \times 52 mm \times 157 mm

Panel Size (approx.):

188 mm \times 58 mm \times 13 mm

Mass (approx.):

1.7 kg (excluding accessories)

Design and specifications are subject to change without notice.

- Microsoft and Windows Media are either registered trademarks or trademarks of Microsoft Corporation in the United States and/or other countries.
- SD logo is a trademark.



Having TROUBLE with operation?

Please reset your unit

Refer to page of How to reset your unit

Vous avez des PROBLÈMES de fonctionnement?

Réinitialisez votre appareil

Référez-vous à la page intitulée Comment réinitialiser votre appareil

JVC



EN, FR

© 2005 Victor Company of Japan, Limited

0205MNMMDWJEIN

JVC KD-SHX751

Installation/Connection Manual Manuel d'installation/raccordement

LVT1311-010A
[EX/EU]

0205MNMMDWJEIN
EN, FR

ENGLISH

This receiver is designed to operate on **12 V DC, NEGATIVE ground electrical systems**. If your vehicle does not have this system, a voltage inverter is required, which can be purchased at JVC IN-CAR ENTERTAINMENT dealers.

FRANÇAIS

Cet appareil est conçu pour fonctionner sur des sources de **courant continu de 12 V à masse NEGATIVE**. Si votre véhicule n'offre pas ce type d'alimentation, il vous faut un convertisseur de tension, que vous pouvez acheter chez un revendeur d'autoradios JVC.

Parts list for installation and connection

The following parts are provided for this receiver.
After checking them, please set them correctly.

(A) / (B)
Hard case/Control panel
Etui de transport/Panneau de commande

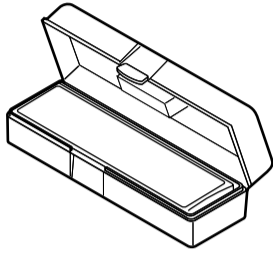

(C)
Sleeve
Manchon

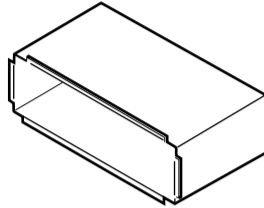

(D)
Trim plate
Plaque d'assemblage

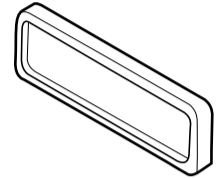

(E)
Power cord
Cordon d'alimentation

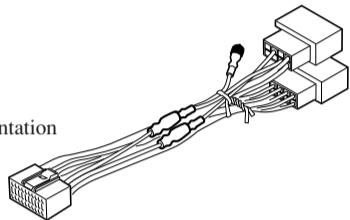

(F)
Washer (ø5)
Rondelle (ø5)



(G)
Lock nut (M5)
Ecrou d'arrêt (M5)



(H)
Mounting bolt (M5 x 20 mm)
Boulon de montage (M5 x 20 mm)

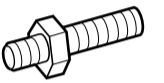

(I)
Rubber cushion
Amortisseur en caoutchouc



(J)
Handles
Poignées

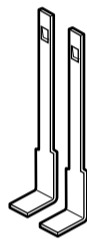

(K)
Remote controller
Télécommande

RM-RK300



(L)
Battery
Pile



(M)
CD-ROM
(Image Converter: Color Ver. 2.0)
CD-ROM
(Image Converter: Color Ver. 2.0)



INSTALLATION (IN-DASH MOUNTING)

The following illustration shows a typical installation. If you have any questions or require information regarding installation kits, consult your JVC IN-CAR ENTERTAINMENT dealer or a company supplying kits.

• If you are not sure how to install this receiver correctly, have it installed by a qualified technician.

INSTALLATION (MONTAGE DANS LE TABLEAU DE BORD)

L'illustration suivante est un exemple d'installation typique. Si vous avez des questions ou avez besoin d'information sur des kits d'installation, consulter votre revendeur d'autoradios JVC ou une compagnie d'approvisionnement.

• Si l'on n'est pas sûr de pouvoir installer correctement cet appareil, le faire installer par un technicien qualifié.

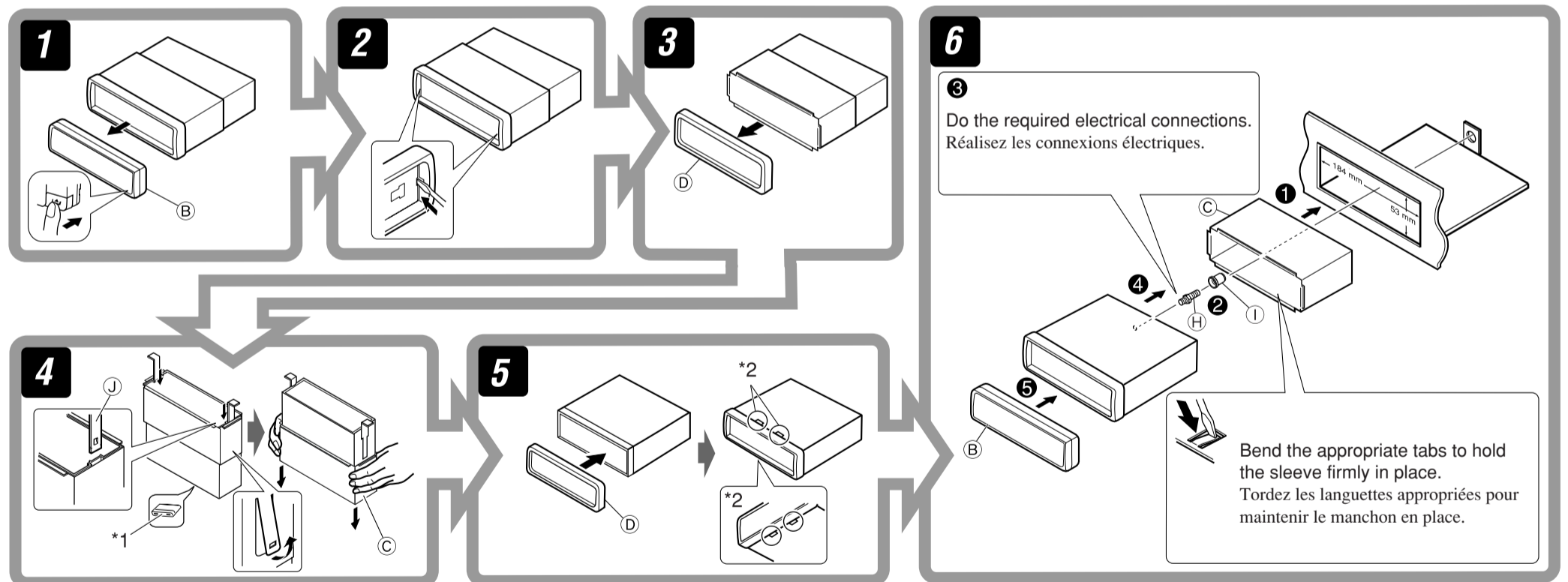

*1 When you stand the receiver, be careful not to damage the fuse on the rear.

*1 Lorsque vous mettez l'appareil à la verticale, faire attention de ne pas endommager le fusible situé sur l'arrière.

*2 Fit the protrusions outside the receiver.

*2 Fixez les protubérances à l'extérieur de l'appareil.

Removing the receiver

Before removing the receiver, release the rear section.

Retrait de l'appareil

Avant de retirer l'appareil, libérer la section arrière.

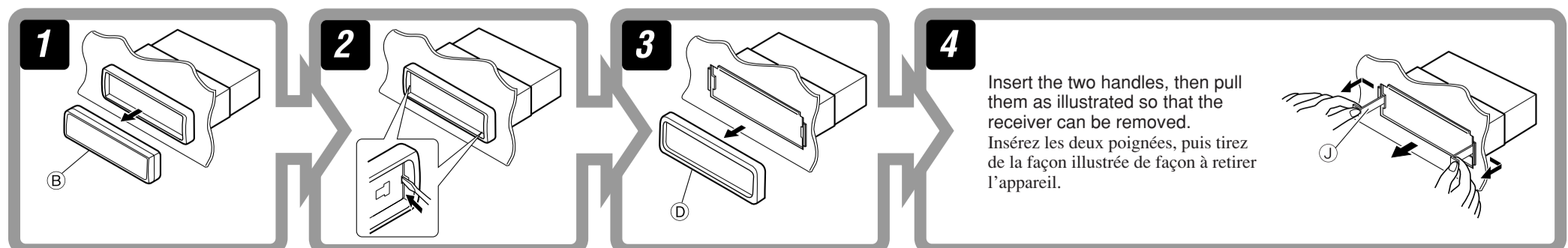

When using the optional stay / Lors de l'utilisation du hauban en option

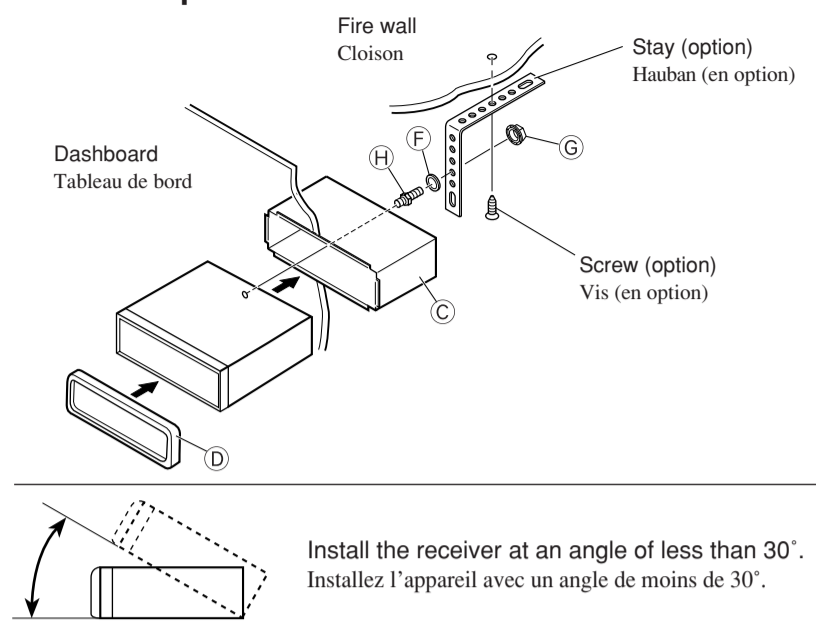

Install the receiver at an angle of less than 30°.
Installez l'appareil avec un angle de moins de 30°.

When installing the receiver without using the sleeve / Lors de l'installation de l'appareil sans utiliser de manchon

In a Toyota for example, first remove the car radio and install the receiver in its place.
Par exemple dans une Toyota, retirer d'abord l'autoradio et installer l'appareil à la place.

Flat type screws (M5 x 8 mm) *3
Vis à tête plate (M5 x 8 mm) *3

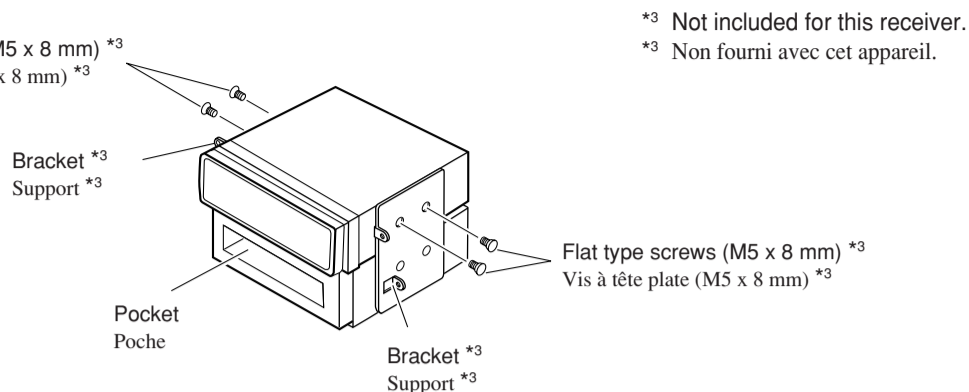

Note : When installing the receiver on the mounting bracket, make sure to use the 8 mm-long screws. If longer screws are used, they could damage the receiver.

Remarque : Lors de l'installation de l'appareil sur le support de montage, s'assurer d'utiliser des vis d'une longueur de 8 mm. Si des vis plus longues sont utilisées, elles peuvent endommager l'appareil.

Caution when installing / Précautions lors de l'installation:

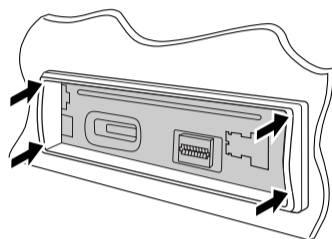

Fit the receiver into the mounting sleeve by using four corners of the trim plate.

- DO NOT press the panel (shaded in the illustration).
- Fixez l'autoradio sur le manchon de montage en utilisant les quatre coins de la plaque de garniture.
- NE PUSSEZ PAS sur le panneau (en gris sur l'illustration).

ELECTRICAL CONNECTIONS

To prevent short circuits, we recommend that you disconnect the battery's negative terminal and make all electrical connections before installing the receiver.

- Be sure to ground this receiver to the car's chassis again after installation.

Notes:

- Replace the fuse with one of the specified rating. If the fuse blows frequently, consult your JVC IN-CAR ENTERTAINMENT dealer.
- It is recommended to connect to the speakers with maximum power of more than 52 W (both at the rear and at the front, with an impedance of 4 Ω to 8 Ω). If the maximum power is less than 52 W, change "Amp Gain" setting to prevent the speakers from being damaged (see page 39 of the INSTRUCTIONS).
- To prevent short-circuit, cover the terminals of the UNUSED leads with insulating tape.
- The heat sink becomes very hot after use. Be careful not to touch it when removing this receiver.

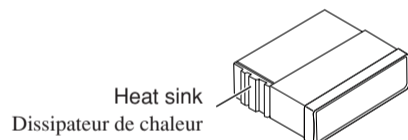

RACCORDEMENTS ELECTRIQUES

Pour éviter tout court-circuit, nous vous recommandons de débrancher la borne négative de la batterie et d'effectuer tous les raccordements électriques avant d'installer l'appareil.

- Assurez-vous de raccorder de nouveau la mise à la masse de cet appareil au châssis de la voiture après l'installation.

Remarques:

- Remplacer le fusible par un de la valeur précisée. Si le fusible saute souvent, consulter votre revendeur d'autoradios JVC.
- Il est recommandé de connecter des enceintes avec une puissance de plus de 52 W (les enceintes arrière et les enceintes avant, avec une impédance comprise entre 4 Ω et 8 Ω). Si la puissance maximum est inférieure à 52 W, changez "Amp Gain" pour éviter d'endommager vos enceintes (voir page 39 du MANUEL D'INSTRUCTIONS).
- Pour éviter les court-circuits, couvrir les bornes des fils qui ne sont PAS UTILISÉS avec de la bande isolante.
- Le dissipateur de chaleur devient très chaud après usage. Faire attention de ne pas le toucher en retirant cet appareil.

PRECAUTIONS on power supply and speaker connections:

- DO NOT connect the speaker leads of the power cord to the car battery; otherwise, the receiver will be seriously damaged.
- BEFORE connecting the speaker leads of the power cord to the speakers, check the speaker wiring in your car.

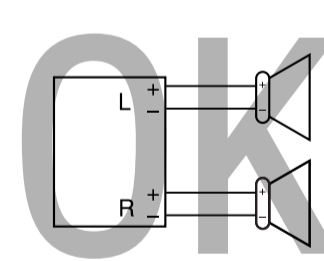
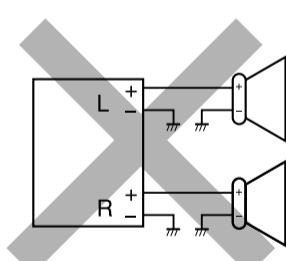
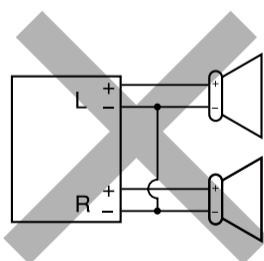

PRECAUTIONS sur l'alimentation et la connexion des enceintes:

- NE CONNECTEZ PAS les fils d'enceintes du cordon d'alimentation à la batterie; sinon, l'appareil serait sérieusement endommagé.
- AVANT de connecter les fils d'enceintes du cordon d'alimentation aux enceintes, vérifiez le câblage des enceintes de votre voiture.

TROUBLESHOOTING

- **The fuse blows.**
 - * Are the red and black leads connected correctly?
- **Power cannot be turned on.**
 - * Is the yellow lead connected?
- **No sound from the speakers.**
 - * Is the speaker output lead short-circuited?
- **Sound is distorted.**
 - * Is the speaker output lead grounded?
 - * Are the "-" terminals of L and R speakers grounded in common?
- **Noise interfere with sounds.**
 - * Is the rear ground terminal connected to the car's chassis using shorter and thicker cords?
- **This receiver becomes hot.**
 - * Is the speaker output lead grounded?
 - * Are the "-" terminals of L and R speakers grounded in common?
- **This receiver does not work at all.**
 - * Have you reset your receiver?

EN CAS DE DIFFICULTES

- **Le fusible saute.**
 - * Les fils rouge et noir sont-ils raccordés correctement?
- **L'appareil ne peut pas être mise sous tension.**
 - * Le fil jaune est-elle raccordée?
- **Pas de son des enceintes.**
 - * Le fil de sortie d'enceinte est-il court-circuité?
- **Le son est déformé.**
 - * Le fil de sortie d'enceinte est-il à la masse?
 - * Les bornes "-" des enceintes gauche et droit sont-elles mises ensemble à la masse?
- **Interférence avec les sons.**
 - * La prise arrière de mise à la terre est-elle connectée au châssis de la voiture avec un cordon court et épais?
- **L'appareil devient chaud.**
 - * Le fil de sortie d'enceinte est-il à la masse?
 - * Les bornes "-" des enceintes gauche et droit sont-elles mises ensemble à la masse?
- **Cet appareil ne fonctionne pas du tout.**
 - * Avez-vous réinitialisé votre appareil?

A If your car is equipped with the ISO connector / Si votre voiture est équipée d'un connecteur ISO

- Connect the ISO connectors as illustrated.
- Connectez les connecteurs ISO comme montré sur l'illustration.

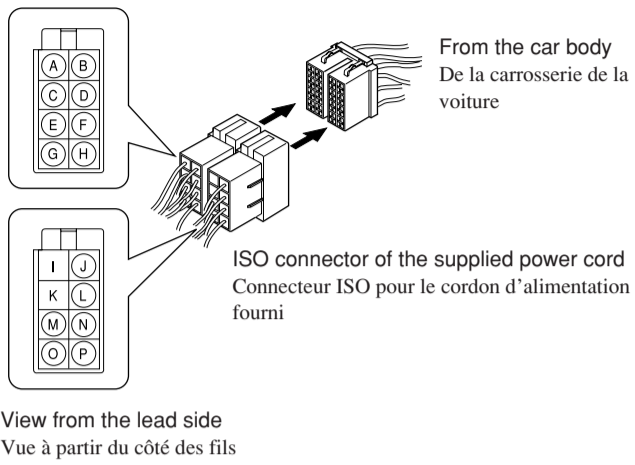

For some VW/Audi or Opel (Vauxhall) automobile / Pour certaine voiture VW/Audi ou Opel (Vauxhall)

- You may need to modify the wiring of the supplied power cord as illustrated.
- Contact your authorized car dealer before installing this receiver.
 - Vous aurez peut-être besoin de modifier le câblage du cordon d'alimentation fourni comme montré sur l'illustration.
 - Contactez votre revendeur automobile autorisé avant d'installer l'appareil.

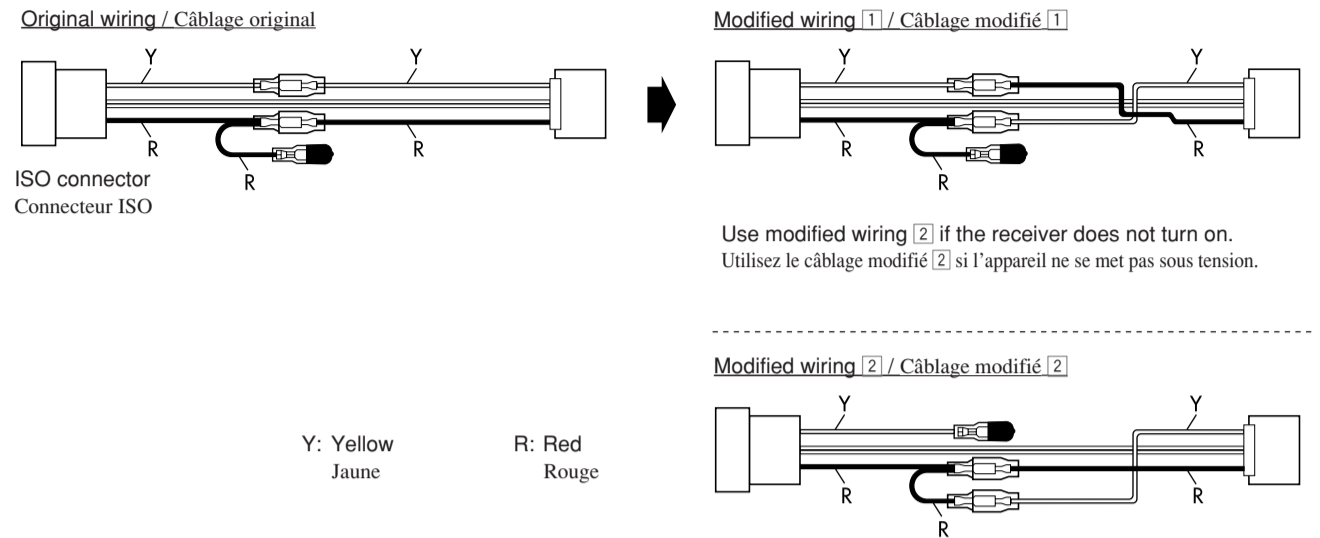

B Connections without using the ISO connectors / Connexions sans l'utilisation des connecteurs ISO

Before connecting: Check the wiring in the vehicle carefully. Incorrect connection may cause serious damage to this receiver.
The leads of the power cord and those of the connector from the car body may be different in color.

- 1 Cut the ISO connector.
- 2 Connect the colored leads of the power cord in the order specified in the illustration below.
- 3 Connect the aerial cord.
- 4 Finally connect the wiring harness to the receiver.

Avant de commencer la connexion: Vérifiez attentivement le câblage du véhicule. Une connexion incorrecte peut endommager sérieusement l'appareil.
Le fil du cordon d'alimentation et ceux des connecteurs du châssis de la voiture peuvent être différents en couleur.

- 1 Coupez le connecteur ISO.
- 2 Connectez les fils colorés du cordon d'alimentation dans l'ordre spécifié sur l'illustration ci-dessous.
- 3 Connectez le cordon d'antenne.
- 4 Finalement, connectez le faisceau de fils à l'appareil.

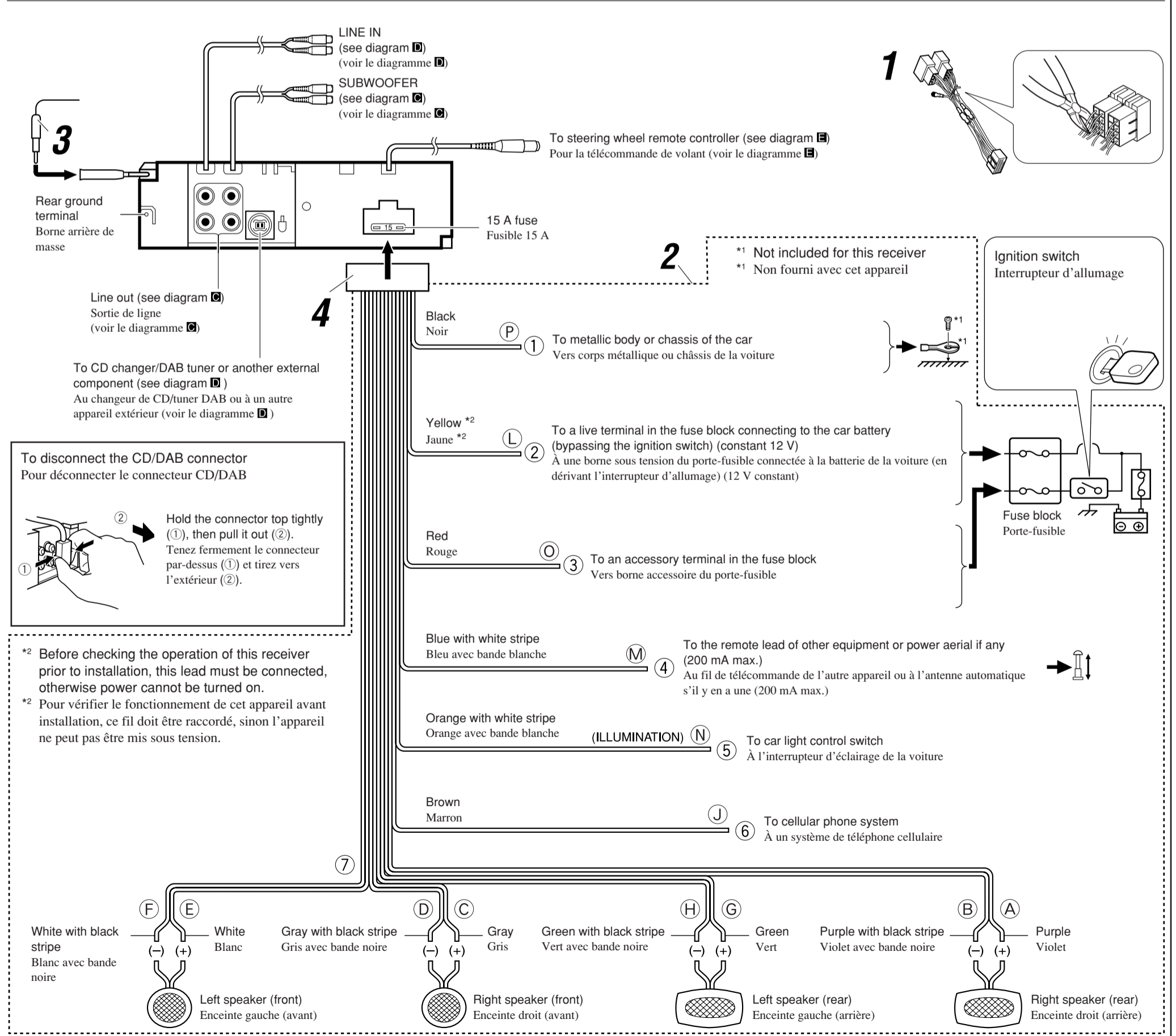

C Connecting the external amplifiers / Connexion d'amplificateurs extérieurs

You can connect amplifiers to upgrade your car stereo system.

- Connect the remote lead (blue with white stripe) to the remote lead of the other equipment so that it can be controlled through this receiver.

• For amplifier only:

- Disconnect the speakers from this receiver, connect them to the amplifier. Leave the speaker leads of this receiver unused.
- You can switch off the built-in amplifier and send the audio signals only to the external amplifier(s) to get clear sounds and to prevent internal heat built-up inside the receiver (see page 39 of the INSTRUCTIONS).
- The line output level of this receiver is kept high to maintain the hi-fi sounds reproduced from this receiver.

When connecting an external amplifier to this receiver, turn down the gain control on the external amplifier to obtain the best performance from this receiver.

Vous pouvez connecter des amplificateurs pour améliorer votre système autoradio.

- Connectez le fil de commande à distance (bleu avec bande blanche) au fil de commande à distance de l'autre appareil de façon qu'il puisse être commandé via cet appareil.

• Pour l'amplificateur seulement:

- Déconnectez les enceintes de cet appareil et connectez-les à l'amplificateur. Laissez les fils d'enceintes de cet appareil inutilisés.
- Vous pouvez désactiver l'amplificateur intégré et envoyer les signaux audio uniquement à un ou plusieurs amplificateurs extérieurs afin d'obtenir un son clair et pour éviter un échauffement interne de l'appareil (voir page 39 du MANUEL D'INSTRUCTIONS).
- Le niveau de sortie de ligne de cet appareil est maintenu à un niveau élevé pour maintenir une qualité Hi-Fi pour les sons reproduits par cet appareil.

Lors de la connexion d'un amplificateur extérieur à cet appareil, diminuez le réglage du gain sur l'amplificateur extérieur pour obtenir les meilleures performances de cet appareil.

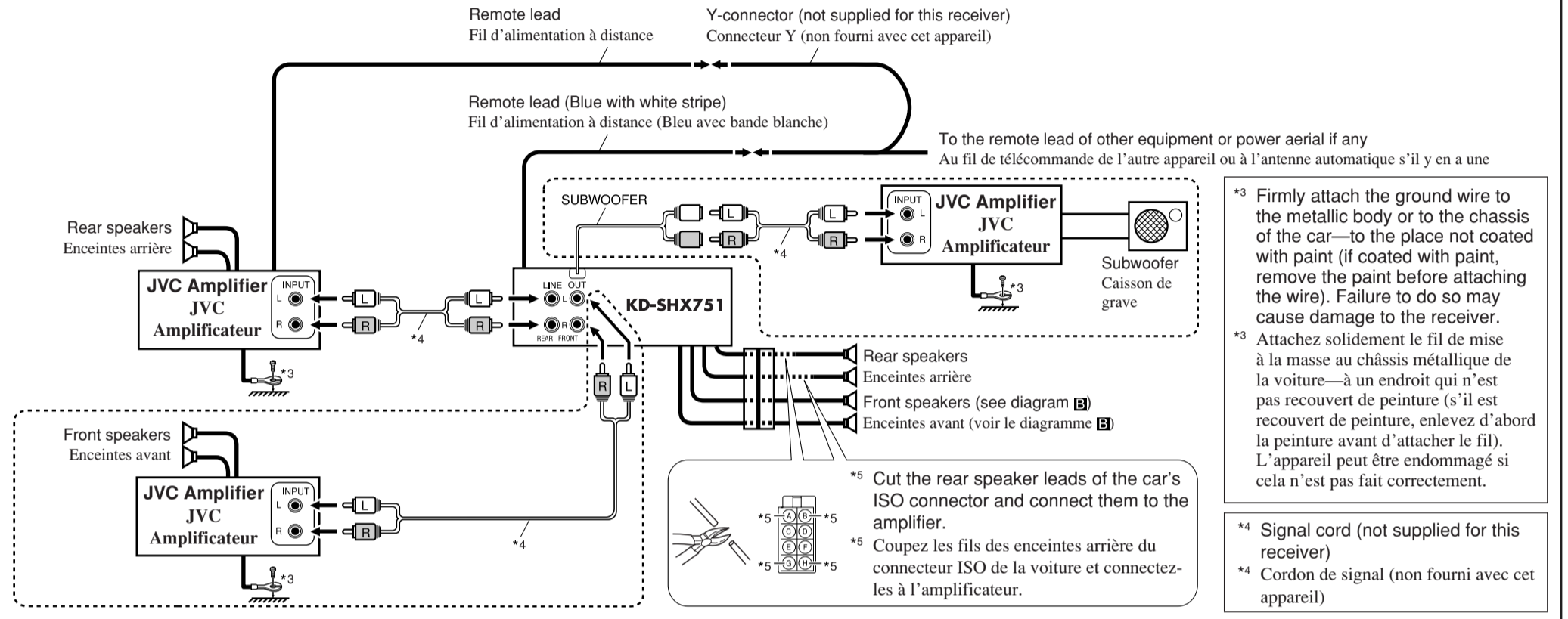

*3 Firmly attach the ground wire to the metallic body or to the chassis of the car—to the place not coated with paint (if coated with paint, remove the paint before attaching the wire). Failure to do so may cause damage to the receiver.

*3 Attachez solidement le fil de mise à la masse au châssis métallique de la voiture—à un endroit qui n'est pas recouvert de peinture (s'il est recouvert de peinture, enlevez d'abord la peinture avant d'attacher le fil). L'appareil peut être endommagé si cela n'est pas fait correctement.

*4 Signal cord (not supplied for this receiver)
*4 Cordon de signal (non fourni avec cet appareil)

D Connecting the external components / Connexion d'un autre appareil extérieur

CD changer and DAB tuner / Changeur de CD et tuner DAB

- You can connect both components in series as illustrated below.
- Vous pouvez connecter les deux appareils en série comme montré sur l'illustration.

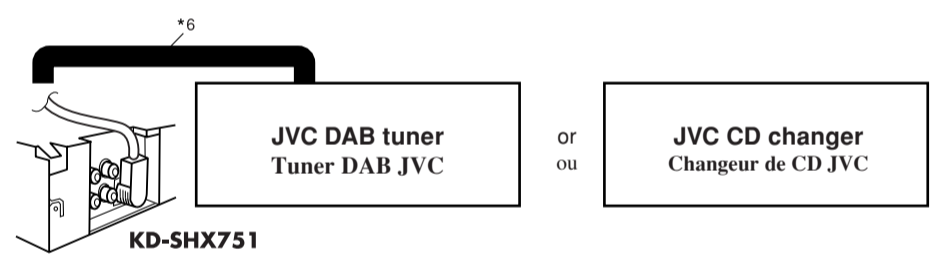
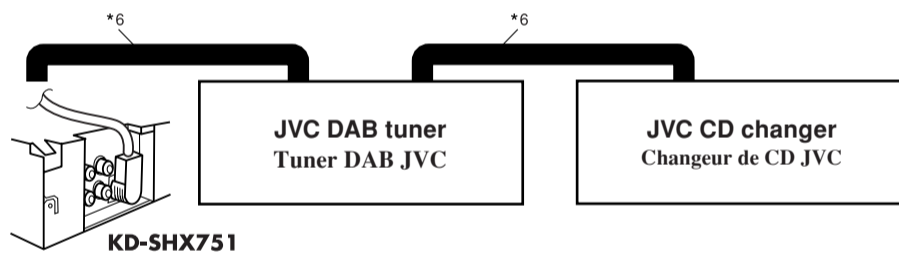

CAUTION / PRECAUTION:

- Before connecting the CD changer and/or DAB tuner, make sure that the receiver is turned off.
- Avant de connecter le changeur de CD et/ou le tuner DAB, s'assurer que l'unité est éteinte.

*6 Connecting cord supplied for your CD changer or DAB tuner
*6 Cordon de connexion fourni avec votre changeur de CD ou tuner DAB

External Component / Appareil extérieur

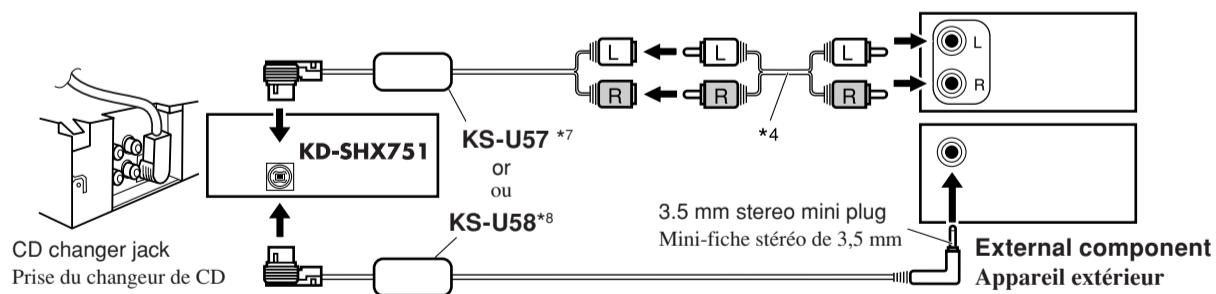

*7 Line Input Adapter KS-U57 (optionally purchased)
*7 Adaptateur d'entrée de ligne KS-U57 (vendu séparément)

*8 Aux Input Adapter KS-U58 (optionally purchased)
*8 Adaptateur d'entrée auxiliaire KS-U58 (vendu séparément)

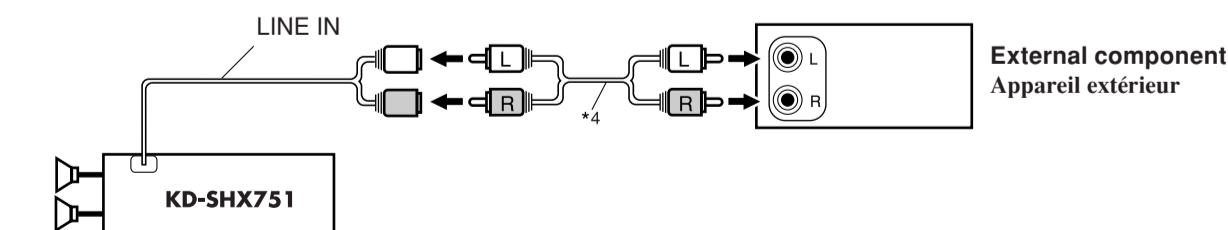

E Connecting to the steering wheel remote controller / Connexion de la télécommande de volant

If your car is equipped with the steering wheel remote controller, you can operate this receiver using the controller. To do it, a JVC's OE remote adapter (not supplied) which matches with your car is required. Consult your JVC IN-CAR ENTERTAINMENT dealer for details.

Si votre voiture est munie d'une télécommande de volant, vous pouvez commander cet autoradio en utilisant la télécommande. Pour le faire, un adaptateur pour télécommande au volant JVC (non fourni) correspondant à votre voiture est nécessaire. Consultez votre revendeur d'autoradio JVC pour les détails.

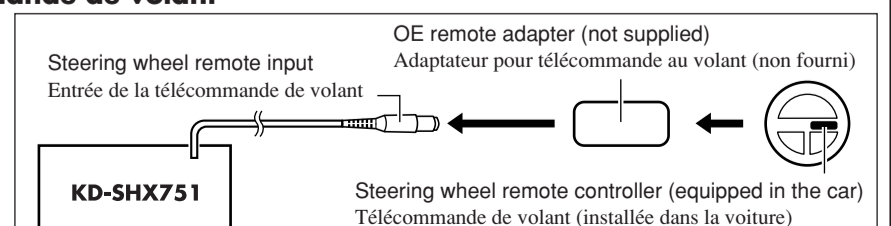

Free Manuals Download Website

<http://myh66.com>

<http://usermanuals.us>

<http://www.somanuals.com>

<http://www.4manuals.cc>

<http://www.manual-lib.com>

<http://www.404manual.com>

<http://www.luxmanual.com>

<http://aubethermostatmanual.com>

Golf course search by state

<http://golfingnear.com>

Email search by domain

<http://emailbydomain.com>

Auto manuals search

<http://auto.somanuals.com>

TV manuals search

<http://tv.somanuals.com>