

JVC



ENGLISH

РУССКИЙ

CASSETTE RECEIVER РЕСИВЕР С КАССЕТНЫМ ПРОИГРЫВАТЕЛЕМ

KS-F315

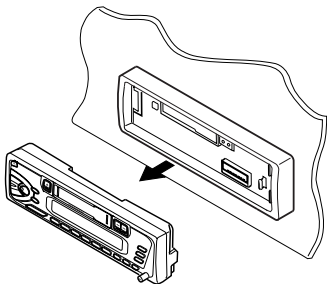

For installation and connections, refer to the separate manual.

Указания по установке и выполнению соединений приводятся в отдельной инструкции.

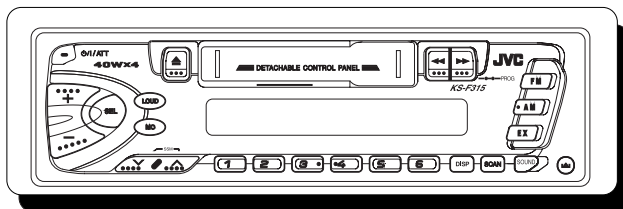

В соответствии с Законом Российской Федерации "О защите прав потребителей" срок службы (годности) данного товара "по истечении которого он может представлять опасность для жизни, здоровья потребителя, причинять вред его имуществу или окружающей среде" составляет семь (7) лет со дня производства. Этот срок является временем, в течение которого потребитель данного товара может безопасно им пользоваться при условии соблюдения инструкции по эксплуатации данного товара, проводя необходимое обслуживание, включающее замену расходных материалов и/или соответствующее ремонтное обеспечение в специализированном сервисном центре.

Дополнительные косметические материалы к данному товару, поставляемые вместе с ним, могут храниться в течение двух (2) лет со дня его производства.

Срок службы (годности), кроме срока хранения дополнительных косметических материалов, упомянутых в предыдущих двух пунктах, не затрагивает никаких других прав потребителя, в частности, гарантийного свидетельства JVC, которое он может получить в соответствии с законом о правах потребителя или других законов, связанных с ним.

INSTRUCTIONS

ИНСТРУКЦИИ ПО ЭКСПЛУАТАЦИИ



GET0002-001A
(EE)

Thank you for purchasing a JVC product. Please read all instructions carefully before operation, to ensure your complete understanding and to obtain the best possible performance from the unit.

CONTENTS

BASIC OPERATIONS	3
RADIO OPERATIONS	4
Listening to the radio	4
Storing stations in memory	5
FM station automatic preset: SSM	5
Manual preset	6
Storing your favorite stations into the one-touch operation button (EX)	7
Tuning into a preset station	8
Other convenient tuner functions	9
Scanning broadcast stations	9
Selecting FM reception sound	9
TAPE OPERATIONS	10
Listening to a tape	10
SOUND ADJUSTMENTS	11
Turning on/off the loudness function	11
Selecting preset sound modes	11
Adjusting the sound	12
Storing your own sound adjustments	13
OTHER MAIN FUNCTIONS	14
Setting the clock	14
Detaching the control panel	15
MAINTENANCE	16
To extend the lifetime of the unit	16
How to Reset your unit	16
TROUBLESHOOTING	17
SPECIFICATIONS	18

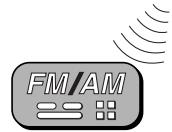

BEFORE USE

* For safety...

- Do not raise the volume level too much, as this will block outside sounds, making driving dangerous.
- Stop the car before performing any complicated operations.

* Temperature inside the car...

If you have parked the car for a long time in hot or cold weather, wait until the temperature in the car becomes normal before operating the unit.

BASIC OPERATIONS

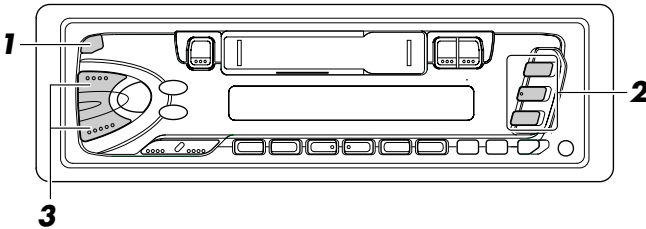

Note:

When you use this unit for the first time, set the built-in clock correctly, see page 14.

1

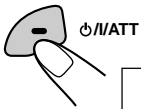

Turn on the power.

Notes on One-Touch Operation:

- When you select tuner as a source in step 2 below, the power automatically comes on. You do not have to press this button to turn on the power.
- If the cassette is already in the cassette compartment, tape play starts automatically.

2

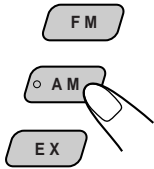

Play the source.

To operate the tuner, see pages 4 – 9.

To operate the tape deck, see page 10.

EX (extra) button: To use this button, you need to preset your favorite station in advance. For details, see pages 7 - 8.

3

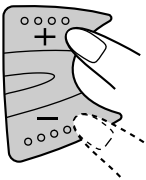

Adjust the volume.

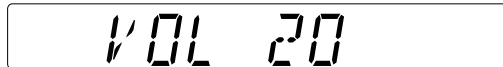

Volume level appears

4

Adjust the sound as you want (see pages 11 – 13).

To drop the volume in a moment

Press \odot /I/ATT briefly while listening to any source. "ATT" starts flashing on the display, and the volume level will drop in a moment.

To resume the previous volume level, press the button briefly again.

To turn off the power

Press \odot /I/ATT for more than 1 second.



RADIO OPERATIONS

ENGLISH

Listening to the radio

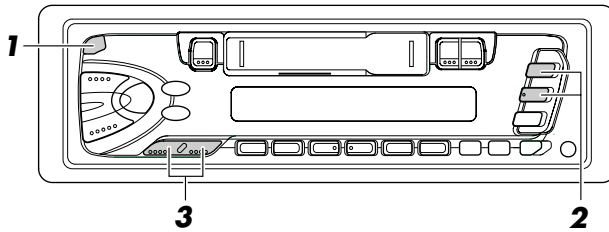

Turn on the power.

Note on One-Touch Operation:

When you select a band in step 2 below, the power automatically comes on. You do not have to press this button to turn on the power.

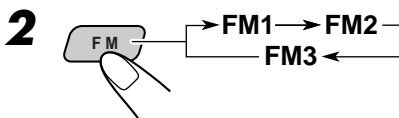

Select the band (FM1, FM2, FM3 or AM).

You can select any one of FM1, FM2, and FM3 to listen to an FM station.

FM1 and FM2: 87.5 - 108 MHz
FM3: 65 - 74 MHz

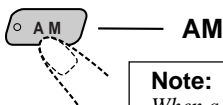

Note:

When a cassette is in the cassette compartment, you cannot select the tuner. Be sure to eject the cassette from the cassette compartment to listen to the radio.

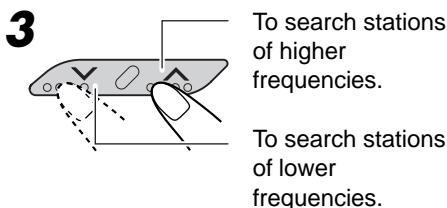

Start searching a station.

When a station is received, searching stops.



To stop searching before a station is received, press the same button you have pressed for searching.

To tune in a particular frequency manually:

- 1 Press FM or AM to select the band.
- 2 Press and hold \wedge or \vee until "M" starts flashing on the display.
Now you can manually change the frequency while "M" is flashing.
- 3 Press \wedge or \vee repeatedly until the frequency you want is reached.
 - If you hold down the button, the frequency keeps changing (in 50 kHz intervals (87.5 - 108 MHz), in 30 kHz intervals (65 - 74 MHz) for FM and 9 kHz intervals for AM — MW/LW) until you release the button.

Storing stations in memory

You can use one of the following two methods to store broadcasting stations in memory.

- Automatic preset of FM stations: SSM (Strong-station Sequential Memory)
- Manual preset of both FM and AM stations.

FM station automatic preset: SSM

You can preset 6 local FM stations in each FM band (FM1, FM2 and FM3).

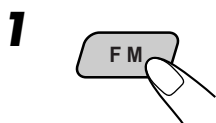
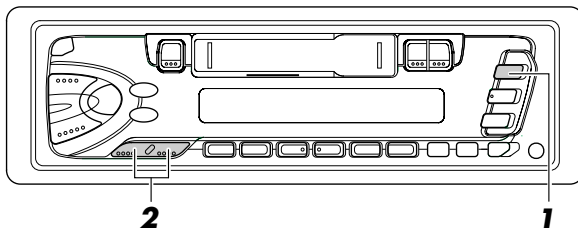

Select the FM band number (FM1, FM2 or FM3) you want to store FM stations into.

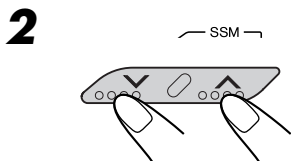

Press and hold the button for more than 2 seconds.

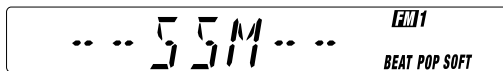

"SSM" appears, then disappears when automatic preset is over.

Local FM stations with the strongest signals are searched and stored automatically in the band number you have selected (FM1, FM2 or FM3). These stations are preset in the number buttons — No. 1 (lowest frequency) to No. 6 (highest frequency).

When automatic preset is over, the station stored in number button 1 will be automatically tuned in.



Manual preset

You can preset up to 6 stations in each band (FM1, FM2, FM3 and AM) manually.

Example: Storing an FM station of 88.3 MHz into the preset number 1 of the FM1 band.

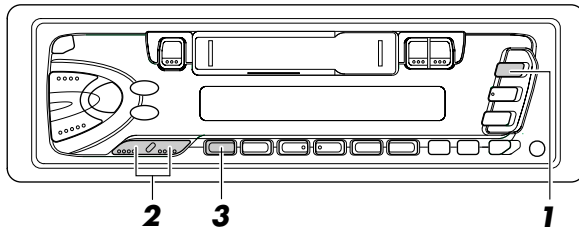

1

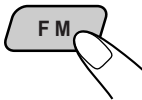

Select the FM1 band.



2

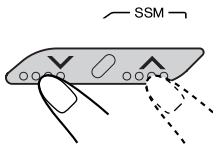

Tune into a station of 88.3 MHz.

See page 4 to tune into a station.



3



Press and hold the button for more than 2 seconds.

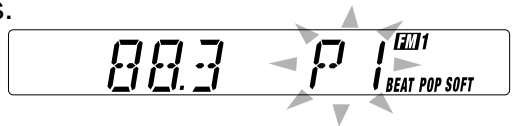

Preset number "P1" flashes for a while.

4

Repeat the above procedure to store other stations into other preset numbers.

Notes:

- A previously preset station is erased when a new station is stored in the same preset number.
- Preset stations are erased when the power supply to the memory circuit is interrupted (for example, during battery replacement). If this occurs, preset the stations again.

Storing your favorite stations into the one-touch operation button (EX-extra)

You can preset an FM or AM station (such as your favorite station or traffic announcement station); and recall it by one touch operation even if the unit is turned off.

EXAMPLE: Storing an FM station of 88.3 MHz into the one-touch operation button (EX).

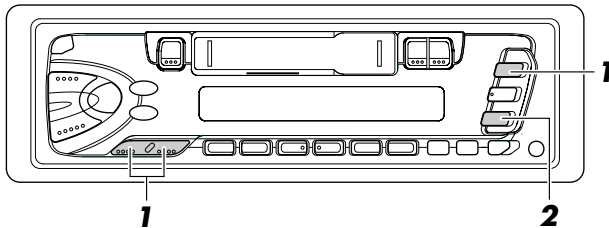
1

Follow the steps **1** and **2** on page 6.

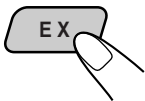
2

Press and hold the button for more than 2 seconds.

"P0" flashes on the display, showing that the station has been preset.

Notes:

- A previously preset station is erased when a new station is stored.
- Preset station are erased when the power supply to the memory circuit is interrupted (for example, during battery replacement). If this occurs, preset the station again.



Tuning into a preset station

You can easily tune into a preset station.

Remember that you must store stations first. If you have not stored them yet, see page 5 or 6.

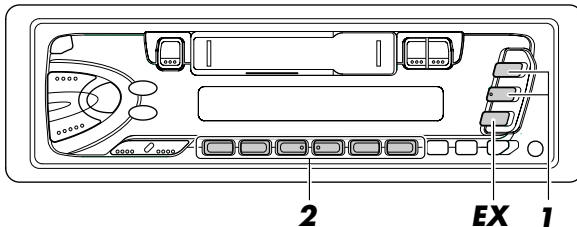

1

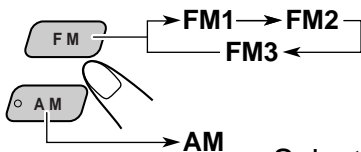

Select the band (FM1, FM2, FM3 or AM) you want.

2

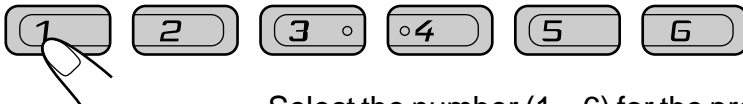

Select the number (1 – 6) for the preset station you want.

To tune in the favorite station



The unit automatically turns on (if it has been off).

Your favorite station is turned in – except when the tape is playing.

- If you press the button again, the last received station will be turned in.

Other convenient tuner functions

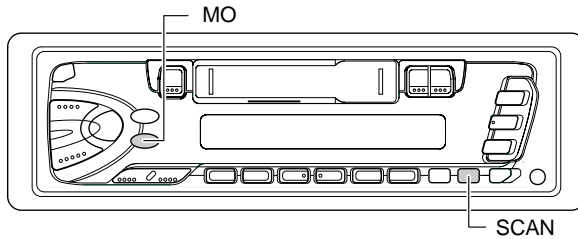

Scanning broadcast stations

When you press SCAN while listening to the radio, station scanning starts. Each time a broadcast is tuned in, scanning stops for about 5 seconds (tuned frequency number flashes on the display), and you can check what program is now being broadcast.

If you want to listen to that program, press the same button again to stop scanning.

Selecting FM reception sound

When an FM stereo broadcast is hard to receive:

Press MO while listening to an FM stereo broadcast. The sound you hear becomes monaural but reception will be improved.

Lights when receiving an FM broadcast in stereo



To restore the stereo effect, press the same button again.



TAPE OPERATIONS

ENGLISH

Listening to a tape

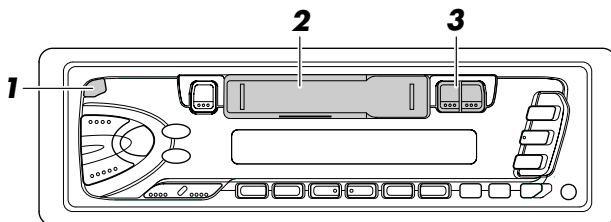

1



Turn on the power.

2

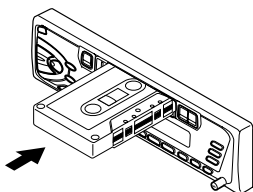

Insert a cassette.

When one side of the tape reaches its end during play, the other side of the tape automatically starts playing. (Auto Reverse)

3

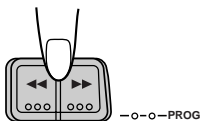

Select the tape direction.

• Press the both buttons at the same time.

Each time you press the button, the tape direction changes alternatively – forward (TAPE >>>) and reverse (TAPE <<<).

To stop play and eject the cassette

Press ▲.

Tape play stops and the cassette ejects from the cassette compartment.

You can hear the last received station.

• You can also eject the cassette with the unit turned off.

To fast-wind a tape

Press either ►► or ◀◀.

The tape will be wound in the direction of the arrows (►► or ◀◀).

To restart playback, press ►► or ◀◀ lightly.

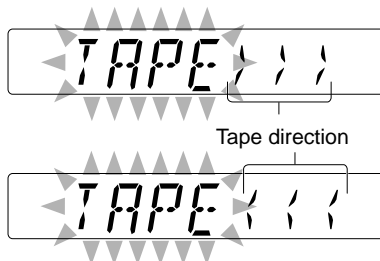

SOUND ADJUSTMENTS

Turning on/off the loudness function

The human ear is less sensitive to low and high frequencies at low volumes. The loudness function can boost these frequencies to produce a well-balanced sound at low volume levels.

Each time you press LOUD, the loudness function turns on/off alternatively.

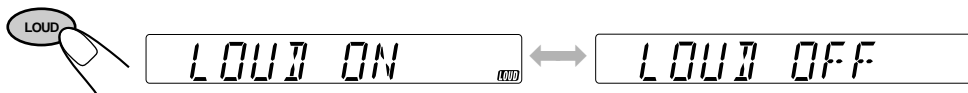

Selecting preset sound modes

You can select a preset sound adjustment suitable to the music genre.

Each time you press SOUND, the sound mode changes as follows.



Indication	For:	Preset values		
		Bass	Treble	Loudness
SCM OFF	(Flat sound)	00	00	On
BEAT	Rock or disco music	+2	00	On
POP	Light music	+4	+1	Off
SOFT	Quiet background music	+1	-3	Off

Notes:

- You can adjust the preset sound mode to your preference, and store it in memory. If you want to adjust and store your original sound mode, see “Storing your own sound adjustments” on page 13.
- To adjust only the bass and treble reinforcement levels to your preference, see “Adjusting the sound” on page 12.
- When one of the sound modes is selected, it is shown on the display as follows:

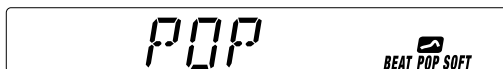

For example, when “POP” is selected.



Adjusting the sound

You can adjust the treble/bass sound and the speaker balance.

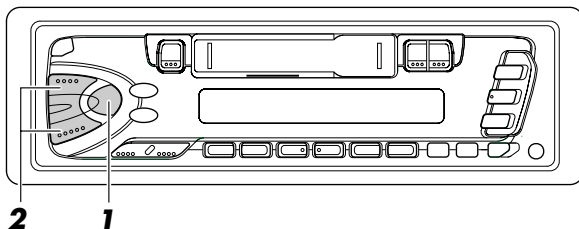

1

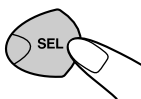

Select the item you want to adjust.

→ **BAS** → **TRE** → **FAD** → **BAL** → **VOL**

Indication	To do:	Range
BAS (bass)	Adjust the bass	-6 (min.) — +6 (max.)
TRE (treble)	Adjust the treble	-6 (min.) — +6 (max.)
FAD (Fader)*	Adjust the front and rear speaker balance	R6 (rear only) — F6 (front only)
BAL (Balance)	Adjust the left and right speaker balance	L6 (left only) — R6 (right only)
VOL (Volume)	Adjust the volume	00 (min.) — 50 (max.)

Note:

* If you are using a two-speaker system, set the fader level to "00".

2

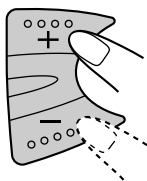

Adjust the level.

Note:

Normally the + and - buttons work as the volume control buttons. So you do not have to select "VOL" to adjust the volume level.

Storing your own sound adjustments

You can adjust the sound modes (BEAT, POP, SOFT: see page 11) to your preference and store your own adjustments in memory.

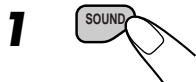
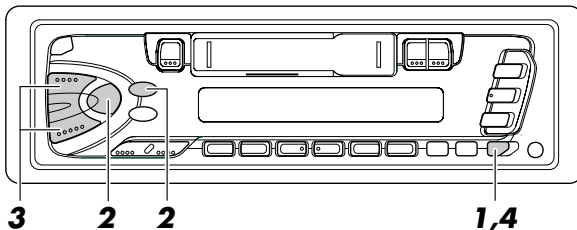

Call up the sound mode you want to adjust.
See page 11 for details.

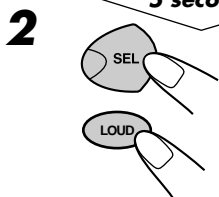

To adjust the bass or treble sound level
Select "BAS" or "TRE."

To turn on or off the loudness function
Each time you press LOUD, the loudness function turns on and off alternatively. (→ go to step 4)

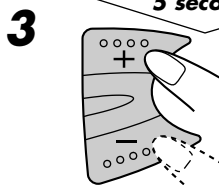

Adjust the bass or treble level.
See page 12 for details.

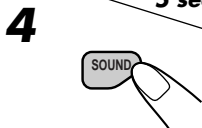

Press and hold SOUND until the sound mode you have selected in step **1** flashes on the display.
Your setting is stored in memory.

5 Repeat the same procedure to store other settings.

To reset to the factory settings

Repeat the same procedure and reassign the preset values listed in the table on page 11.

Setting the clock

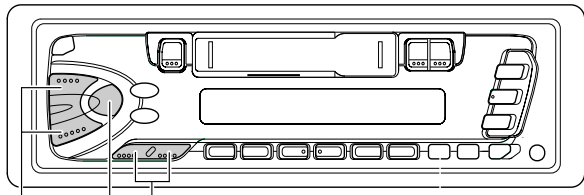

2,3 1,4 2,3

1

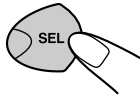

Press and hold the button for more than 2 seconds.
"CLOCK H" or "CLOCK M" appears on the display.

2

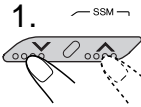
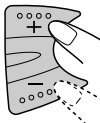
1.  2. 

Set the hour.
1. Select "CLOCK H" if not shown on the display.

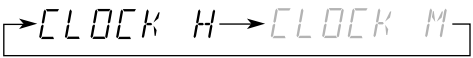

2. Adjust the hour.

3

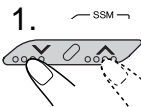
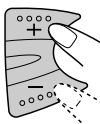
1.  2. 

Set the minute.
1. Select "CLOCK M."

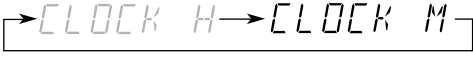

2. Adjust the minute.

4

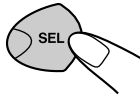

Finish the setting.

To check the current clock time (changing the display mode)

Press DISP repeatedly. Each time you press the button, the display mode changes as follows.

<p>During tuner operation:</p> <p>Frequency ↔ Clock</p>	<p>During tape operation:</p> <p>Play mode ↔ Clock</p>
--	---

Detaching the control panel

You can detach the control panel when leaving the car. When detaching or attaching the control panel, be careful not to damage the connectors on the back of the control panel and on the panel holder.

How to detach the control panel

Before detaching the control panel, be sure to turn off the power.

1 Unlock the control panel.

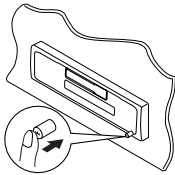

2 Lift and pull the control panel out of the unit.

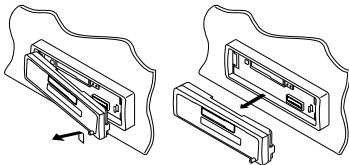

3 Put the detached control panel into the provided case.

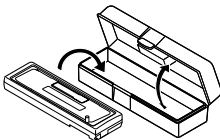

How to attach the control panel

1 Insert the left side of the control panel into the groove on the panel holder.

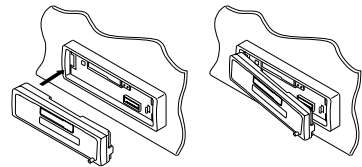

2 Press the right side of the control panel to fix it to the panel holder.

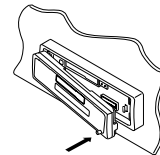

Note on cleaning the connectors:

If you frequently detach the control panel, the connectors will deteriorate. To minimize this possibility, periodically wipe the connectors with a cotton swab or cloth moistened with alcohol, being careful not to damage the connectors.

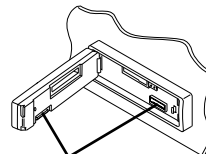

Connectors



MAINTENANCE

ENGLISH

To extend the lifetime of the unit

This unit requires very little attention, but you will be able to extend the life of the unit if you follow the instructions below.

To clean the heads

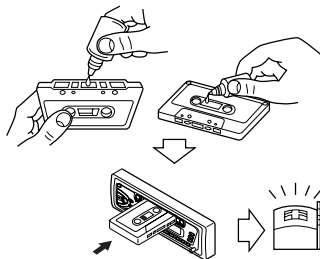

- Clean the heads after every 10 hours of use using a wet-type head cleaning tape (available at an audio store).
When the head becomes dirty, you may realize the following symptoms:
 - Sound quality is reduced.
 - Sound level decreases.
 - Sound drops out.
- Do not play dirty or dusty tapes.
- Do not touch the highly-polished head with any metallic or magnetic tools.

To keep the tape clean

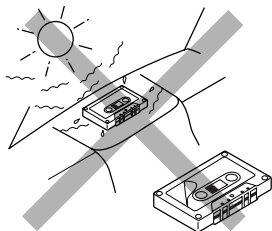

- Always store the tapes to their storage cases after use.
- Do not store tapes in the following places:
 - Subject to direct sunlight
 - With high humidity
 - At extremely hot temperatures

CAUTIONS:

- Do not play the tapes with peeling labels; otherwise, they can damage the unit.
- Tighten tapes to remove slack since loose tape may become entangled with the mechanism.
- Do not leave a cassette in the cassette compartment after use, as the tape may become slack.

How to reset your unit

Press and hold both the SEL (Select) and $\text{O}/\text{I}/\text{ATT}$ (Standby/On/ATT) buttons at the same time for several seconds.

This will reset the built-in microcomputer.

NOTE: Your preset adjustments — such as preset channels or sound adjustments — will also be erased.

$\text{O}/\text{I}/\text{ATT}$
(Standby/On/ATT)

SEL (Select)

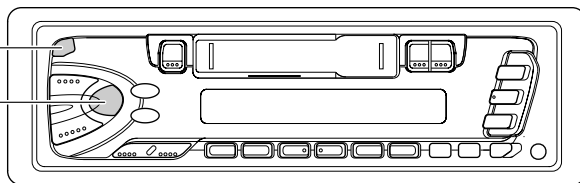

TROUBLESHOOTING

What appears to be trouble is not always serious. Check the following points before calling a service center.

Symptoms	Causes	Remedies
• A cassette tape cannot be inserted.	You have tried to insert a cassette in the wrong way.	Insert the cassette with the exposed tape facing right.
• Cassette tapes become hot.	This is not a malfunction.	_____
• Tape sound is at very low level and sound quality is degraded.	The tape head is dirty.	Clean it with a head cleaning tape.
• Sound is sometimes interrupted.	Connections are not good.	Check the cords and connections.
• Sound cannot be heard from the speakers.	The volume control is turned to the minimum level.	Adjust it to the optimum level.
	Connections are incorrect.	Check the cords and connections.
• Static noise while listening to the radio.	The antenna is not connected firmly.	Connect the antenna firmly.
• The unit does not work at all.	The built-in microcomputer may function incorrectly due to noise, etc.	While holding SEL, press Φ /I/ATT for more than 2 seconds to reset the unit. (The clock setting and preset stations stored in memory are erased.) (See page 16.)

SPECIFICATIONS

AUDIO AMPLIFIER SECTION

Maximum Power Output:

Front: 40 watts per channel

Rear: 40 watts per channel

Continuous Power Output (RMS):

Front: 16 watts per channel into 4 Ω , 40 Hz to 20 000 Hz at no more than 0.8% total harmonic distortion.

Rear: 16 watts per channel into 4 Ω , 40 Hz to 20 000 Hz at no more than 0.8% total harmonic distortion.

Load Impedance: 4 Ω (4 Ω to 8 Ω allowance)

Tone Control Range

Bass: ± 10 dB at 100 Hz

Treble: ± 10 dB at 10 kHz

Frequency Response: 40 Hz to 20 000 Hz

Signal-to-Noise Ratio: 70 dB

Line-Out Level/Impedance: 1.0 V/20 k Ω load
(250 nWb/m)

TUNER SECTION

Frequency Range

FM1/FM2: 87.5 MHz to 108.0 MHz

FM3: 65 MHz to 74 MHz

AM: (MW) 522 kHz to 1 620 kHz
(LW) 144 kHz to 279 kHz

[FM Tuner]

Usable Sensitivity: 11.3 dBf (1.0 μ V/75 Ω)

50 dB Quietening Sensitivity:

16.3 dBf (1.8 μ V/75 Ω)

Alternate Channel Selectivity (400 kHz):

65 dB

Frequency Response: 40 Hz to 15 000 Hz

Stereo Separation: 30 dB

Capture Ratio: 2.0 dB

[MW Tuner]

Sensitivity: 20 μ V

Selectivity: 35 dB

[LW Tuner]

Sensitivity: 50 μ V

CASSETTE DECK SECTION

Wow & Flutter: 0.15% (WRMS)

Fast-Wind Time: 190 sec. (C-60)

Frequency Response:

50 Hz to 14 000 Hz

Signal-to-Noise Ratio: 52 dB

Stereo Separation: 40 dB

GENERAL

Power Requirement

Operating Voltage: DC 14.4 volts (11 volts to 16 volts allowance)

Grounding System: Negative ground

Allowable Working Temperature:

0°C to +40°C

Dimensions (W x H x D)

Installation Size: 182 mm x 52 mm x 150 mm

Panel Size: 188 mm x 58 mm x 14 mm

Mass: 1.3 kg (excluding accessories)

Design and specifications subject to change without notice.



Having TROUBLE with operation?

Please reset your unit

Refer to page of How to reset your unit

Затруднения при эксплуатации?

Пожалуйста, перезагрузите Ваше устройство

Для получения информации о перезагрузке Вашего устройства
обратитесь на соответствующую страницу

JVC
VICTOR COMPANY OF JAPAN, LIMITED

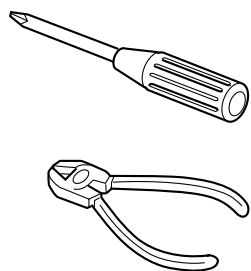

ENGLISH

- This unit is designed to operate on 12 volts DC, NEGATIVE ground electrical systems.

INSTALLATION (IN-DASH MOUNTING)

- The following illustration shows a typical installation. However, you should make adjustments corresponding to your specific car. If you have any questions or require information regarding installation kits, consult your JVC IN-CAR ENTERTAINMENT dealer or a company supplying kits.

РУССКИЙ

- Это устройство разработано для эксплуатации на 12 В постоянного напряжения с минусом на массу.

УСТАНОВКА (УСТАНОВКА В ПРИБОРНУЮ ПАНЕЛЬ)

- На следующих иллюстрациях показана типовая установка. Тем не менее, Вы должны сделать поправки в соответствии с типом Вашего автомобиля. Если у Вас есть какие-либо вопросы, касающиеся установки, обратитесь к Вашему дилеру JVC IN-CAR ENTERTAINMENT или в компанию, поставляющую соответствующие принадлежности.

1 Before mounting: Press (Control Panel Release button) to detach the control panel.

2 Remove the trim plate.

3 Remove the sleeve after disengaging the sleeve locks.

① Stand the unit.

Note: When you stand the unit, be careful not to damage the fuse on the rear.

② Insert the 2 handles between the unit and the sleeve, as illustrated, to disengage the sleeve locks.

③ Remove the sleeve.

Note: Be sure to keep the handles for future use after installing the unit.

4 Install the sleeve into the dashboard.

* After the sleeve is correctly installed into the dashboard, bend the appropriate tabs to hold the sleeve firmly in place, as illustrated.

5 Fix the mounting bolt to the rear of the unit's body and place the rubber cushion over the end of the bolt.

6 Do the required electrical connections.

7 Slide the unit into the sleeve until it is locked.

8 Attach the trim plate so that the projection on the trim plate is fixed to the left side of the unit.

9 Attach the control panel.

1 Перед установкой: Нажмите кнопку (кнопка освобождения панели управления) для отсоединения панели управления.

2 Удалите декоративную панель.

3 Удалите муфту после освобождения запоров муфты.

① Установите устройство.

Примечание: Устанавливайте устройство таким образом, чтобы не повредить предохранитель, расположенный сзади.

② Вставьте два рычага между устройством и муфтой, как показано на рисунке, для освобождения запоров муфты.

③ Удалите муфту.

Примечание: После установки устройства сохраните рычаги для использования в будущем.

4 Установите муфту в приборную панель.

* После установки муфты в приборную панель согните соответствующие зубцы для фиксации муфты, как показано на рисунке.

5 Затяните фиксирующий болт на задней части корпуса устройства и наденьте резиновый чехол на конец болта.

6 Выполните необходимые подключения контактов, как показано на оборотной стороне этой инструкции.

7 Задвиньте устройство в муфту до упора.

8 Прикрепите декоративную панель таким образом, чтобы выступ на декоративной панели вошел в левую часть устройства.

9 Прикрепите панель управления.

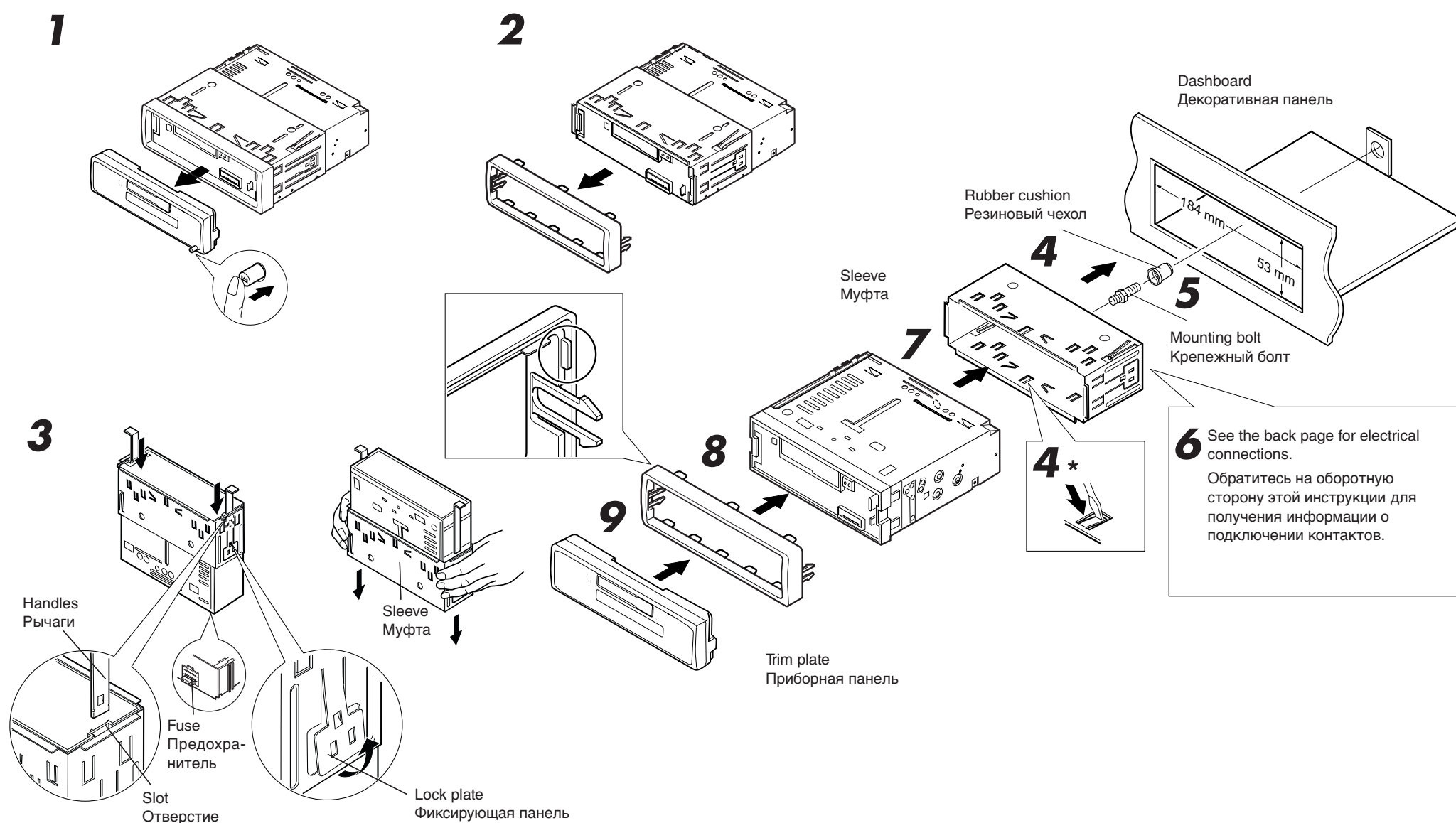

- When using the optional stay
- При использовании дополнительной стойки

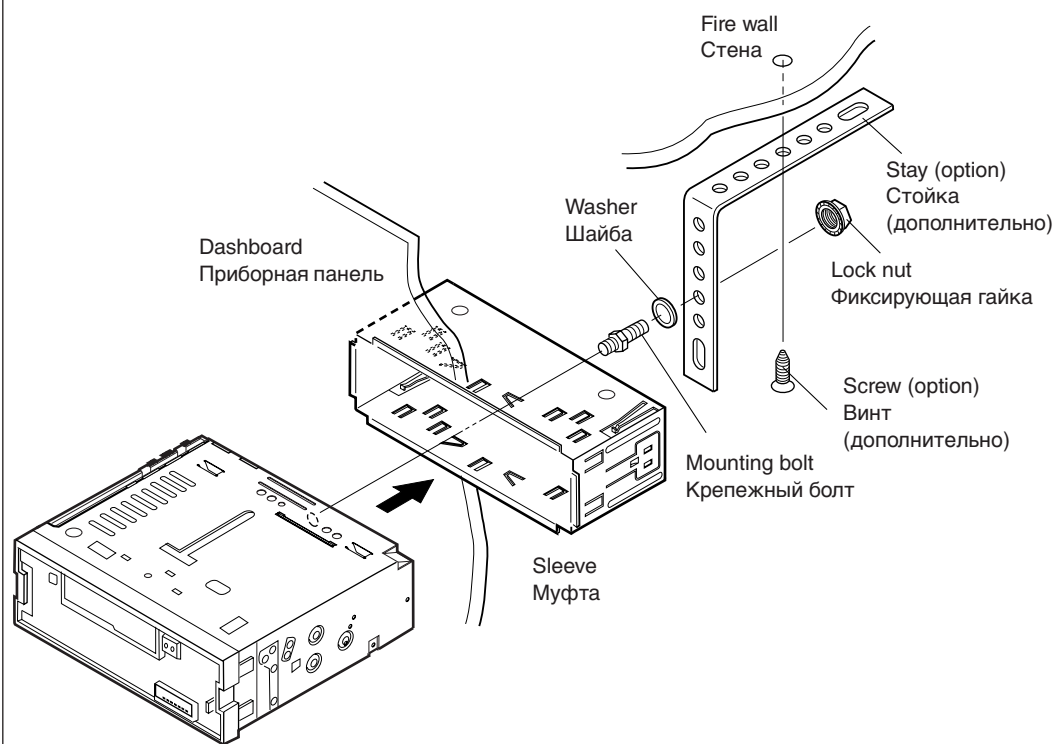

- When installing the unit without using the sleeve
- При установке устройства без использования муфты

In a Toyota for example, first remove the car radio and install the unit in its place.
В Тойоте, например, сначала удалите автомобильную магнитолу, затем установите на ее место это устройство.

Flat type screws (M5 x 6 mm)*
Крепежные винты (M5 x 6 мм)*

* Not included with this unit.
* Не входят в комплект.

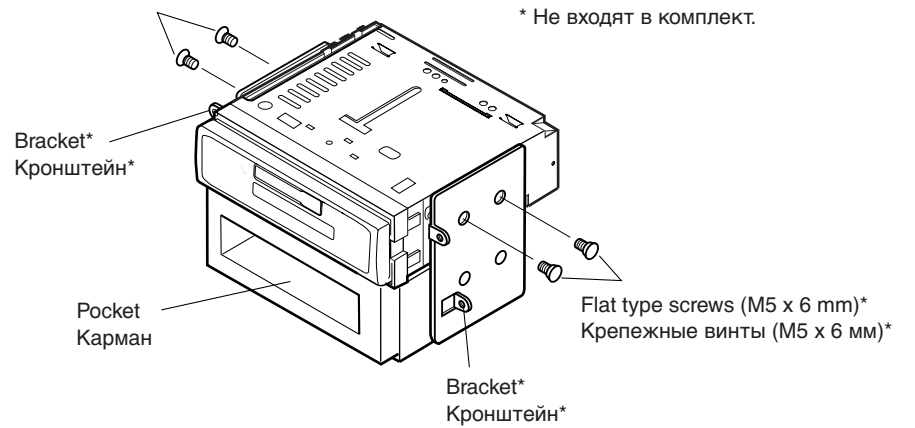

Note: When installing the unit on the mounting bracket, make sure to use the 6 mm-long screws. If longer screws are used, they could damage the unit.

Примечание: При установке устройства на крепежный кронштейн, используйте только винты длиной 6 мм. При использовании более длинных винтов, можно повредить устройство.

Removing the unit

- Before removing the unit, release the rear section.

- 1 Remove the control panel.
- 2 Remove the trim plate.
- 3 Insert the 2 handles into the slots, as shown. Then, while gently pulling the handles away from each other, slide out the unit. **(Be sure to keep the handles after installing it.)**

Удаление устройства

- Перед удалением устройства освободите заднюю часть.

- 1 Удалите панель управления.
- 2 Удалите декоративную панель.
- 3 Вставьте 2 рычага в отверстия, как показано на иллюстрации. Затем, плавно раздвигая рычаги в стороны, выньте устройство. **(После установки сохраните рычаги.)**

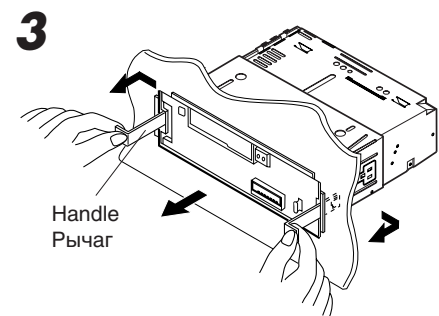
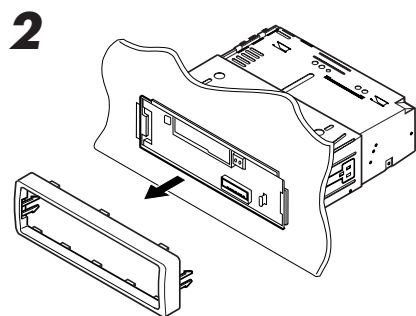
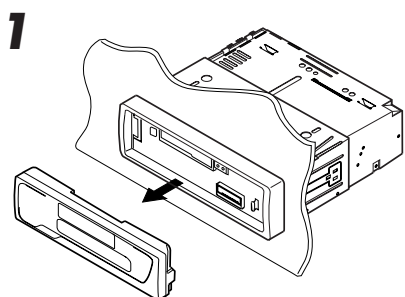

Parts list for installation and connection

The following parts are provided with this unit.
After checking them, please set them correctly.

Hard case
Жесткий футляр

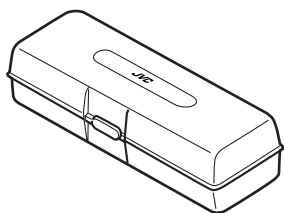

Trim plate
Декоративная панель

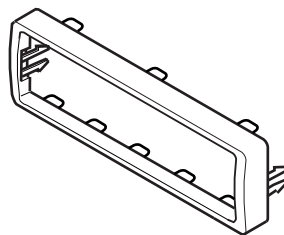

Sleeve
Муфта

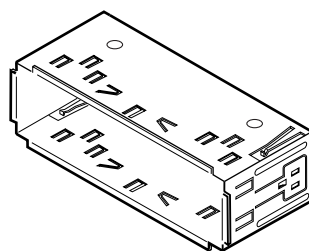

Rubber cushion
Резиновый чехол



Lock nut (M5)
Фиксирующая гайка (M5)



Mounting bolt (M5 x 20 mm)
Крепежный болт (M5 x 20 мм)



Washer (ø5)
Шайба (ø5)



Handles
Рычаги

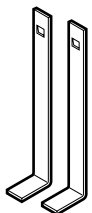

Power cord
Кабель питания

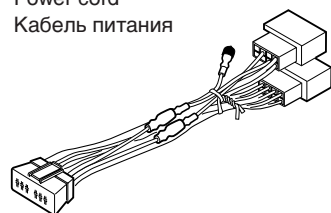

Список деталей для установки и подключения

Следующие детали поставлены в комплекте с устройством.
После проверки комплектации, пожалуйста, установите их правильно.

TROUBLESHOOTING

- **The fuse blows.**
* Are the red and black leads connected correctly?
- **Power cannot be turned on.**
* Is the yellow lead connected?
- **No sound from the speakers.**
* Is the speaker output lead short-circuited?
- **Sound is distorted.**
* Is the speaker output lead grounded?
* Are the “-” terminals of L and R speakers grounded in common?
- **Unit becomes hot.**
* Is the speaker output lead grounded?
* Are the “-” terminals of L and R speakers grounded in common?

ВЫЯВЛЕНИЕ НЕИСПРАВНОСТЕЙ

- **Сработал предохранитель.**
* Правильно ли подключены черный и красный провода?
- **Питание не включается.**
* Подключен ли желтый провод?
- **Звук не выводится через громкоговорители.**
* Нет ли короткого замыкания на кабеле выхода громкоговорителей?
- **Звук искажен.**
* Заземлен ли провод выхода громкоговорителей?
* Заземлены ли разъемы “-” правого (R) и левого (L) громкоговорителей?
- **Устройство нагревается.**
* Заземлен ли провод выхода громкоговорителей?
* Заземлены ли разъемы “-” правого (R) и левого (L) громкоговорителей?

ELECTRICAL CONNECTIONS

To prevent short circuits, we recommend that you disconnect the battery's negative terminal and make all electrical connections before installing the unit. If you are not sure how to install this unit correctly, have it installed by a qualified technician.

Note:

This unit is designed to operate on **12 volts DC, NEGATIVE ground electrical systems**. If your vehicle does not have this system, a voltage inverter is required, which can be purchased at JVC IN-CAR ENTERTAINMENT dealers.

- Replace the fuse with one of the specified rating. If the fuse blows frequently, consult your JVC IN-CAR ENTERTAINMENT dealer.
- If noise is a problem...
This unit incorporates a noise filter in the power circuit. However, with some vehicles, clicking or other unwanted noise may occur. If this happens, connect the unit's **rear ground terminal** (See connection diagram below.) to the car's chassis using shorter and thicker cords, such as copper braiding or gauge wire. If noise still persists, consult your JVC IN-CAR ENTERTAINMENT dealer.
- Maximum input of the speakers should be more than 40 watts at the rear and 40 watts at the front, with an impedance of **4 to 8 ohms**.
- **Be sure to ground this unit to the car's chassis.**
- The heat sink becomes very hot after use. Be careful not to touch it when removing this unit.

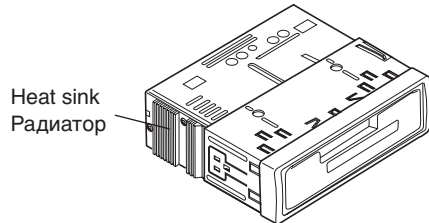

ЭЛЕКТРИЧЕСКИЕ ПОДКЛЮЧЕНИЯ

Для предотвращения коротких замыканий мы рекомендуем Вам отсоединить отрицательный разъем аккумулятора и осуществить все подключения перед установкой устройства. Если Вы не знаете точно, как следует устанавливать это устройство, обратитесь к квалифицированному специалисту.

Примечание:

Это устройство разработано для эксплуатации на **12 В постоянного напряжения с минусом на массе**. Если Ваш автомобиль не имеет этой системы, требуется инвертор напряжения, который может быть приобретен у дилера JVC IN-CAR ENTERTAINMENT.

- Заменяйте предохранитель другим предохранителем указанного класса. Если предохранитель сгорает слишком часто, обратитесь к дилеру JVC IN-CAR ENTERTAINMENT.
- При появлении сильных помех...
Это устройство оснащено фильтром помех в цепи питания. Однако, в некоторых случаях возможно появление щелчков и других нежелательных помех. В этом случае подключите **задний разъем заземления** этого устройства (см. схему подключения ниже) к шасси автомобиля при помощи более коротких и толстых проводов. Если помехи не исчезают, обратитесь к дилеру JVC IN-CAR ENTERTAINMENT.
- Максимальная входная мощность громкоговорителей не должна превышать 40 Вт на задних и 40 Вт на передних громкоговорителях, с расчетным сопротивлением **от 4 до 8 Ом**.
- **Не забудьте заземлить устройство на шасси автомобиля.**
- Радиатор во время использования сильно нагревается. Старайтесь его не трогать во время удаления устройства.

A If your car is equipped with the ISO connector

A Если Ваш автомобиль оборудован разъемами ISO

- Connect the ISO connectors as illustrated.
- Подключите разъемы ISO, как показано на иллюстрации.

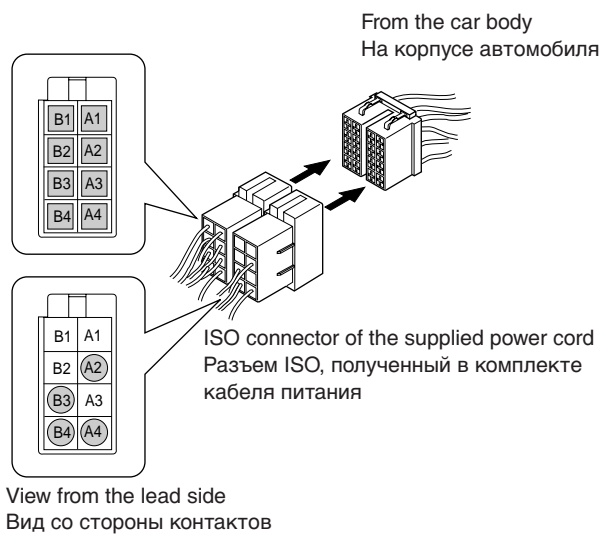

For some VW/Audi or Opel (Vauxhall) automobile

Для некоторых автомобилей VW/Audi или Opel (Vauxhall)

You may need to modify the wiring of the supplied power cord as illustrated.

- Contact your authorized car dealer before installing this unit.

Вам может потребоваться изменение соединений полученного в комплекте кабеля питания, как показано на иллюстрации.

- Перед установкой устройства обратитесь к Вашему официальному дилеру автомобиля.

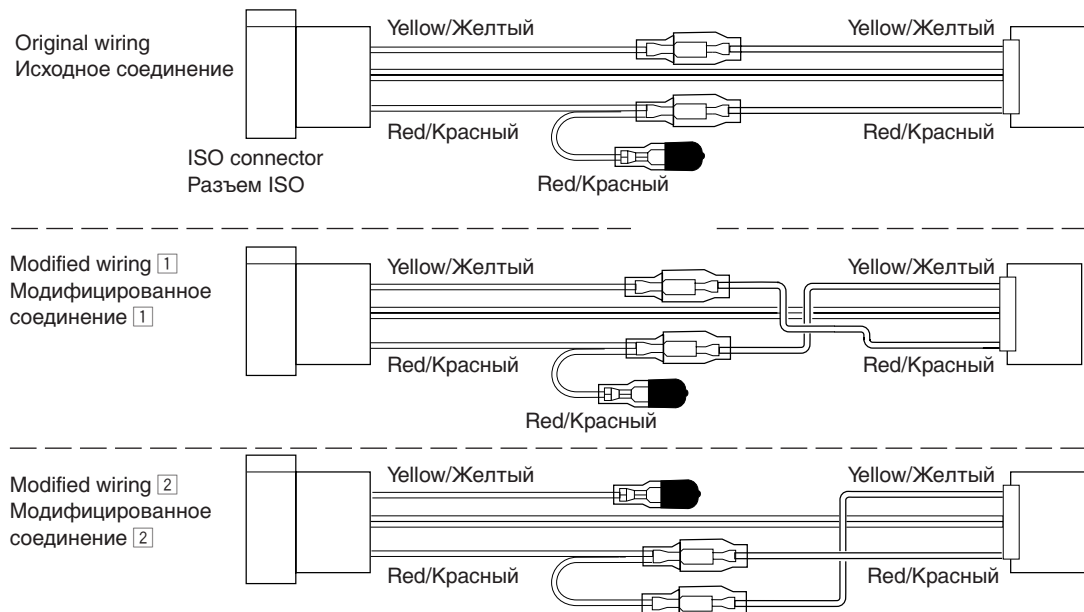

PRECAUTIONS on power supply and speaker connections:

- **DO NOT connect the speaker leads of the power cord to the car battery; otherwise, the unit will be seriously damaged.**
- Connect the black lead (ground), yellow lead (to car battery, constant 12V), and red lead (to an accessory terminal) correctly.
- **BEFORE connecting the speaker leads of the power cord to the speakers, check the speaker wiring in your car.**
 - If the speaker wiring in your car is as illustrated in Fig. 1 and Fig. 2 below, DO NOT connect the unit using that original speaker wiring. If you do, the unit will be seriously damaged. Redo the speaker wiring so that you can connect the unit to the speakers as illustrated in Fig. 3.
 - If the speaker wiring in your car is as illustrated in Fig. 3, you can connect the unit using the original speaker wiring in your car.
 - If you are not sure of the speaker wiring of your car, consult your car dealer.

ПРЕДОСТЕРЕЖЕНИЯ по питанию и подключению громкоговорителей:

- **НЕ подключайте провода громкоговорителей к аккумулятору автомобиля, иначе устройство будет повреждено.**
- Правильно подключите черный провод (земля), желтый провод (в аккумулятор, постоянный 12 В) и красный провод (в вспомогательный разъем).
- **ПЕРЕД** подключением проводов громкоговорителей к кабелю питания громкоговорителя проверьте схему соединений громкоговорителей в Вашем автомобиле.
 - Если соединения громкоговорителей в Вашем автомобиле соответствует иллюстрации 1 и 2, НЕ подключайте устройство при помощи исходного кабеля громкоговорителей. Если Вы это сделаете, устройство будет повреждено. Приведите соединения громкоговорителей в соответствие с изображением на рисунке 3.
 - Если схема соединений громкоговорителей в Вашем автомобиле соответствует иллюстрации 3, Вы можете подключить устройство, используя исходную схему соединений громкоговорителей в Вашем автомобиле.
 - Если Вы не знаете соединения громкоговорителей в Вашем автомобиле, обратитесь к Вашему автомобильному дилеру.

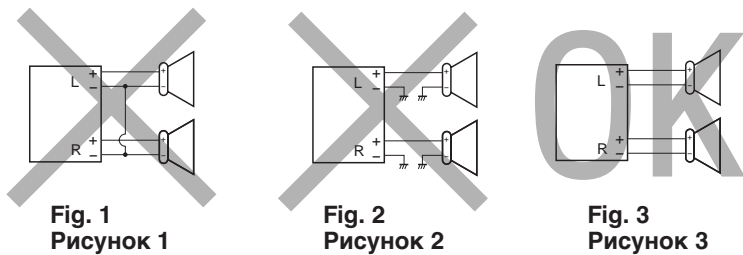

Connecting the leads / Подключение контактов

Twist the core wires when connecting.

Закрутите концы проводов при соединении.

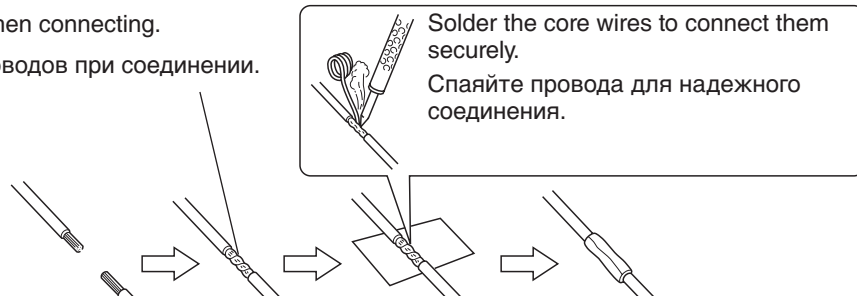

CAUTION / ПРЕДОСТЕРЕЖЕНИЕ:

- To prevent short-circuit, cover the terminals of the UNUSED leads with insulating tape.
- Для предотвращения короткого замыкания заклейте неиспользуемые концы изолирующей лентой.

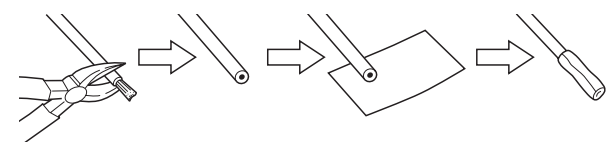

B Connections without using the ISO connectors / Подключение без использования разъемов ISO

Before connecting: Check the wiring in the vehicle carefully not to fail in connecting this unit. Incorrect connection may cause a serious damage to this unit.

1 Cut the ISO connector.

2 Connect the colored leads of the power cord to the car battery, speakers and power aerial (if any) in the following sequence.

- ① Black: ground
- ② Yellow: to car battery (constant 12V)
- ③ Red: to an accessory terminal
- ④ Blue with white stripe: to power aerial (200mA max.)
- ⑤ Others: to speakers.

3 Connect the aerial cord.

4 Finally connect the wiring harness to the unit.

Перед началом подключений: Тщательно проверьте проводку в автомобиле. Неправильное подключение может привести к серьезному повреждению устройства.

1 Отрежьте разъем ISO.

2 Подключите окрашенные концы кабеля питания к аккумулятору, громкоговорителям и автономной антенне (если есть) в следующем порядке.

- ① Черный: земля
- ② Желтый: к аккумулятору (постоянный 12 В)
- ③ Красный: к вспомогательному разъему
- ④ Синий с белой полосой: к питанию антенны (максимум 200 мА).
- ⑤ Прочие: к громкоговорителям.

3 Подключите кабель антенны.

4 В последнюю очередь подключите проводку к устройству.

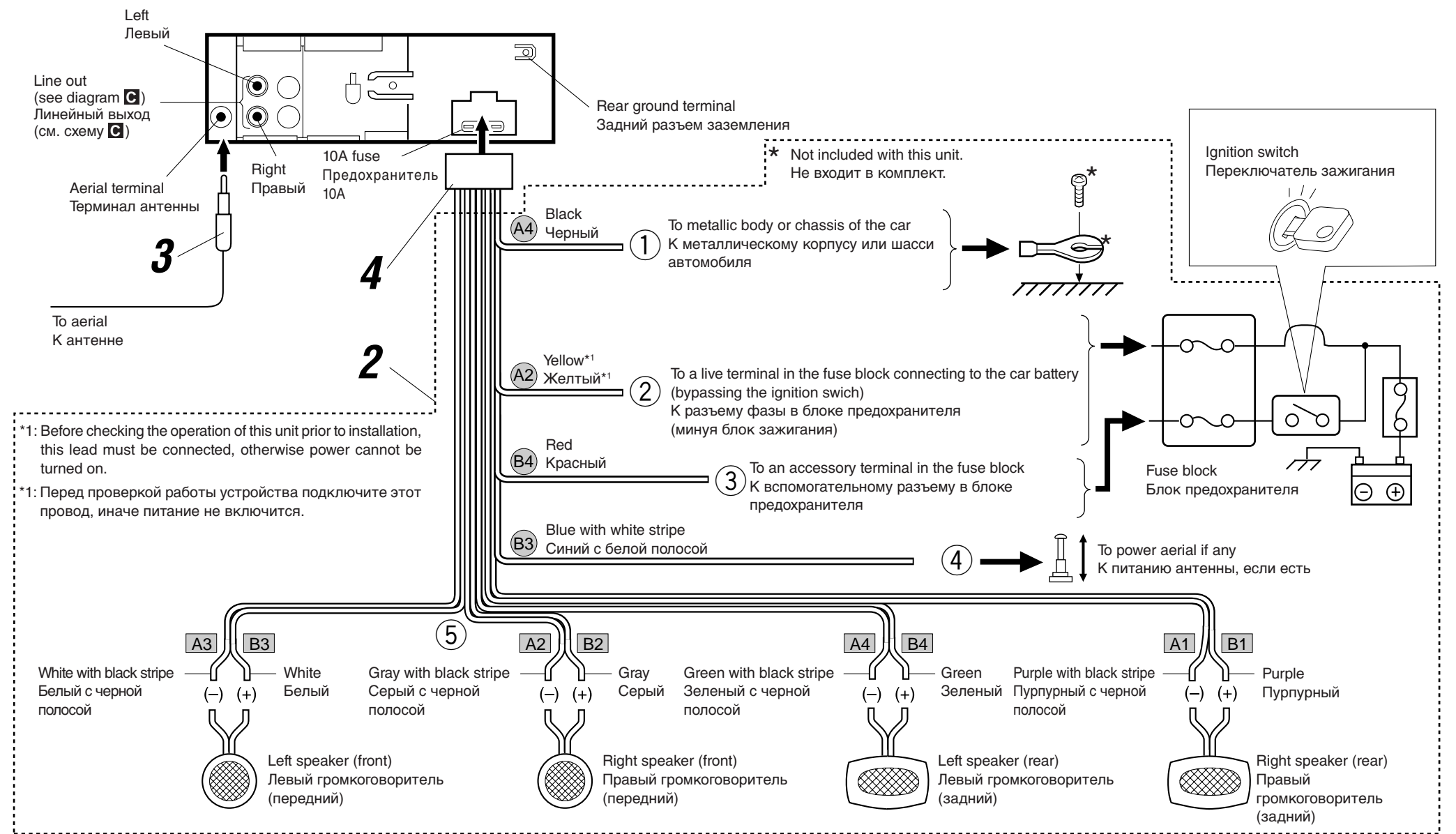

C Connections Adding Other Equipment / Подключение других устройств

Since this unit has line-out terminals, an amplifier and other equipment can be used to upgrade your car stereo system.

- Connect the remote lead (blue with white stripe) to the remote lead of the other equipment so that it can be supplied the power through this unit.
- For amplifier only: Connect this unit's line-out terminals to the amplifier's line-in terminals.

Так как устройство имеет линейные выходные разъемы, к Вашей автомобильной стерео системе может быть подключен усилитель и другое оборудование.

- Подключите внешний провод (синий с белой полосой) к внешнему проводу другого устройства для того, чтобы осуществлять управление дополнительным устройством посредством этого устройства.
- Только для усилителя: Подключите линейные входы этого устройства к линейным входам усилителя.

Amplifier / Усилитель

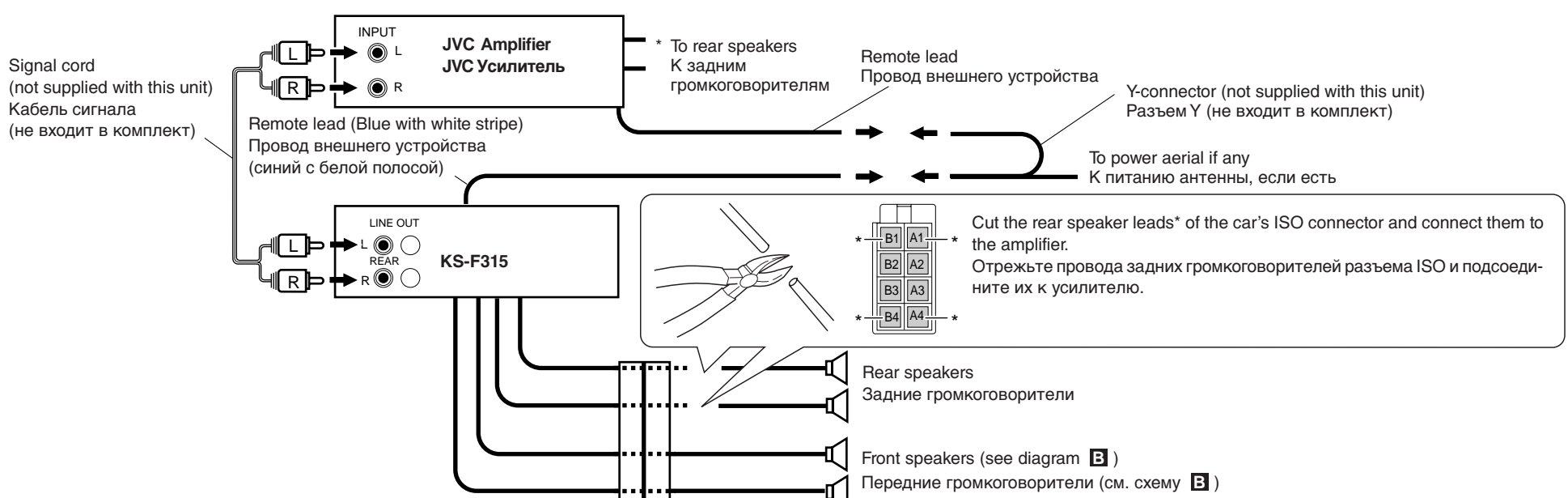

Free Manuals Download Website

<http://myh66.com>

<http://usermanuals.us>

<http://www.somanuals.com>

<http://www.4manuals.cc>

<http://www.manual-lib.com>

<http://www.404manual.com>

<http://www.luxmanual.com>

<http://aubethermostatmanual.com>

Golf course search by state

<http://golfingnear.com>

Email search by domain

<http://emailbydomain.com>

Auto manuals search

<http://auto.somanuals.com>

TV manuals search

<http://tv.somanuals.com>