

JVC

ENGLISH

РУССКИЙ

CASSETTE RECEIVER РЕСИВЕР С КАССЕТНЫМ ПРОИГРЫВАТЕЛЕМ

KS-F545

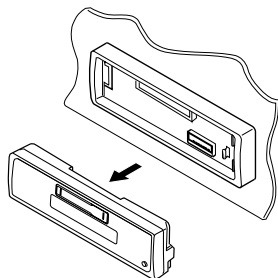
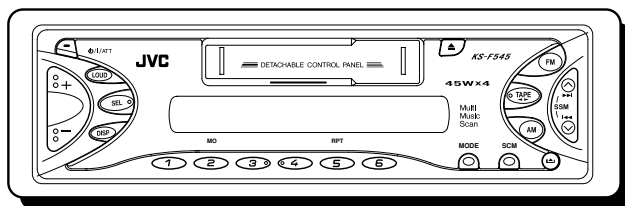

For installation and connections, refer to the separate manual.

Указания по установке и выполнению соединений приводятся в отдельной инструкции.

В соответствии с Законом Российской Федерации "О защите прав потребителей" срок службы (годности) данного товара "по истечении которого он может представлять опасность для жизни, здоровья потребителя, причинять вред его имуществу или окружающей среде" составляет семь (7) лет со дня производства. Этот срок является временем, в течение которого потребитель данного товара может безопасно им пользоваться при условии соблюдения инструкции по эксплуатации данного товара, проводя необходимое обслуживание, включающее замену расходных материалов и/или соответствующее ремонтное обеспечение в специализированном сервисном центре.

Дополнительные косметические материалы к данному товару, поставляемые вместе с ним, могут храниться в течение двух (2) лет со дня его производства.

Срок службы (годности), кроме срока хранения дополнительных косметических материалов, упомянутых в предыдущих двух пунктах, не затрагивает никаких других прав потребителя, в частности, гарантийного свидетельства JVC, которое он может получить в соответствии с законом о правах потребителя или других законов, связанных с ним.

INSTRUCTIONS

ИНСТРУКЦИИ ПО ЭКСПЛУАТАЦИИ



GET0115-001A

[EE]

How to reset your unit

While holding SEL (select), press O/I/ATT (standby/on/attenuator) for more than 2 seconds. This will reset the built-in microcomputer.

Note:

Your preset adjustments — such as preset channels or sound adjustments — will also be erased.

O/I/ATT
(Standby/On/Attenuator)

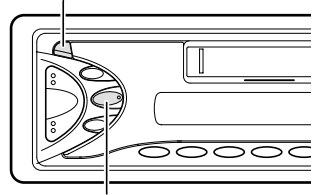

SEL (Select)

How to use the MODE button

If you press MODE, the unit goes into functions mode and the number buttons work as different function buttons.

MODE



MO

RPT

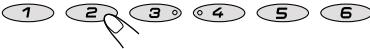

Time countdown indicator

To use these buttons as number buttons again after pressing MODE, wait for 5 seconds without pressing any number button until the functions mode is cleared.

- Pressing MODE again also clears the functions mode.

Thank you for purchasing a JVC product. Please read all instructions carefully before operation, to ensure your complete understanding and to obtain the best possible performance from the unit.

CONTENTS

How to reset your unit	2	OTHER MAIN FUNCTIONS	15
How to use the MODE button	2	Setting the clock	15
LOCATION OF THE BUTTONS	4	Changing the general settings (PSM)	15
Control panel	4	Detaching the control panel	17
BASIC OPERATIONS	5	TROUBLESHOOTING	18
Turning on the power	5	MAINTENANCE	19
RADIO OPERATIONS	6	SPECIFICATIONS	20
Listening to the radio	6		
Storing stations in memory	7		
Tuning in to a preset station	8		
TAPE OPERATIONS	9		
Listening to a cassette	9		
Finding the beginning of a tune	10		
Other convenient tape functions	11		
SOUND ADJUSTMENTS	12		
Adjusting the sound	12		
Turning on/off loudness function	13		
Selecting preset sound modes	13		
Storing your own sound adjustments	14		

BEFORE USE

*For safety....

- Do not raise the volume level too much, as this will block outside sounds, making driving dangerous.
- Stop the car before performing any complicated operations.

*Temperature inside the car....

If you have parked the car for a long time in hot or cold weather, wait until the temperature in the car becomes normal before operating the unit.



LOCATION OF THE BUTTONS

ENGLISH

Control panel

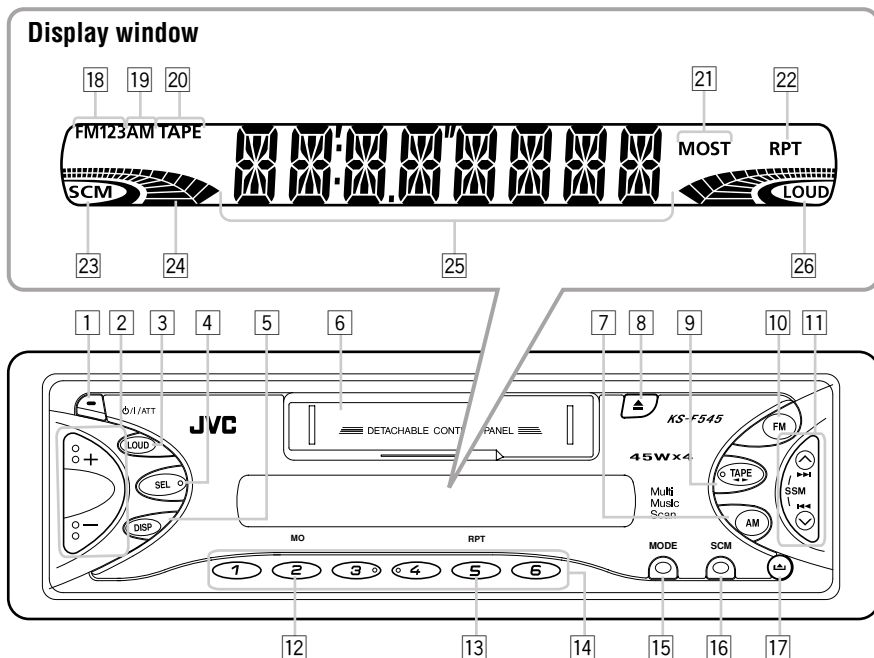

1 ϕ /I/ATT (standby/on/attenuator) button

2 +/- buttons

3 LOUD (loudness) button

4 SEL (select) button

5 DISP (display) button

6 Cassette compartment

7 AM button

8 ▲ (eject) button

9 TAPE ◀▶ button

10 FM button

11 ▶▶ ▲ / I ◀◀ ▼ buttons

• Also functions as SSM buttons when pressed together.

12 MO (monaural) button

13 RPT (repeat) button

14 Number buttons

15 MODE button

16 SCM (sound control memory) button

17 ▲ (control panel release) button

Display window

18 FM band number indicators

FM1, FM2, FM3

19 AM band indicator

20 TAPE indicator

21 Tuner reception indicators

MO (monaural), ST (stereo)

22 RPT (repeat) indicator

23 SCM (sound control memory) indicator

24 Volume (or audio) level indicator

25 Main display

26 LOUD (loudness) indicator

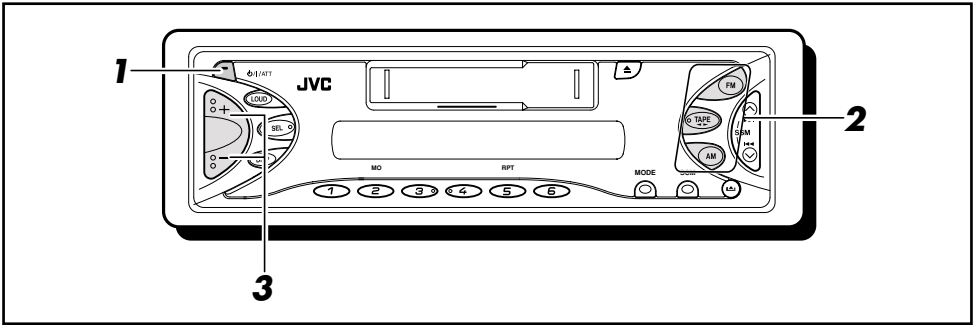

Turning on the power

1 Turn on the power.

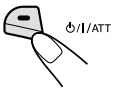

Note on One-Touch Operation:

When you select a source in step 2 below, the power automatically comes on. You do not have to press this button to turn on the power.

2 Select the source.

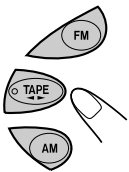

To operate the tuner (FM or AM),
see pages 6 – 8.
To operate the tape,
see pages 9 – 11.

3 Adjust the volume.

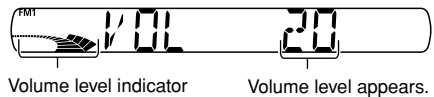
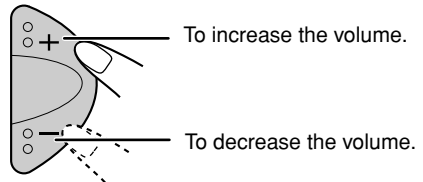

4 Adjust the sound as you want. (See pages 12 – 14.)

To drop the volume in a moment

Press $\text{P}/\text{I}/\text{ATT}$ briefly while listening to any source. "ATT" starts flashing on the display, and the volume level will drop in a moment. To resume the previous volume level, press the button briefly again.

To turn off the power

Press and hold $\text{P}/\text{I}/\text{ATT}$ until "SEE YOU" appears on the display.

Note:

When you use this unit for the first time, set the built-in clock correctly, see page 15.

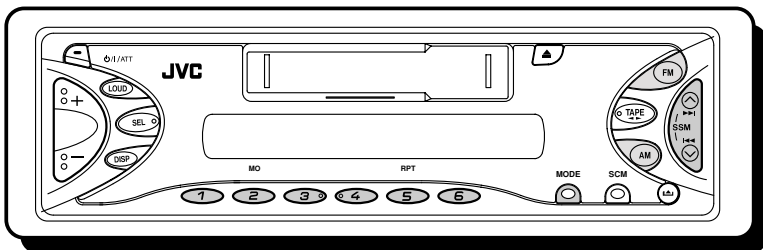

Listening to the radio

You can use either automatic searching or manual searching to tune in to a particular station.

Searching a station automatically: Auto search

1 Select the band (FM1 – 3, AM).

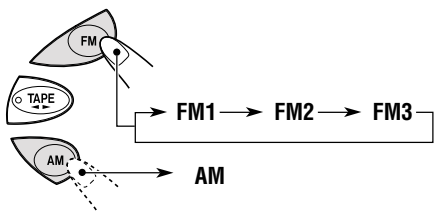

Selected band appears.

Lights up when receiving an FM stereo broadcast with sufficient signal strength.



Note:

This receiver has three FM bands (FM1, FM2, FM3). You can use any one of them to listen to an FM broadcast.

2 Start searching a station.

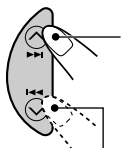

Press **▶▶ ▲** to search stations of higher frequencies.

Press **◀◀ ▼** to search stations of lower frequencies.

When a station is received, searching stops.

To stop searching before a station is received, press the same button you have pressed for searching.

Note:

FM1 and FM2 : 87.5 MHz – 108.0 MHz
FM3 : 65.00 MHz – 74.00 MHz

Searching a station manually: Manual search

1 Select the band (FM1 – 3, AM).

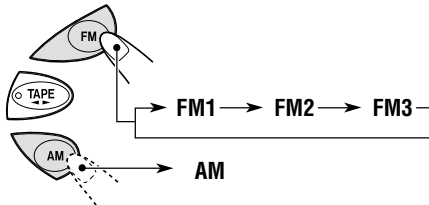

Note:

This receiver has three FM bands (FM1, FM2, FM3). You can use any one of them to listen to an FM broadcast.

2 Press and hold **▶▶ ▲** or **◀◀ ▼** until “M (manual)” starts flashing on the display.

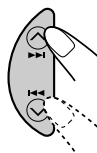

Selected band appears.

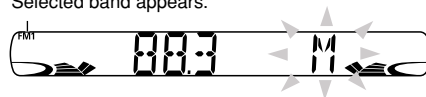

3 Tune in to a station you want while “M” is flashing.

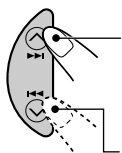

Press ►►► ▲ to tune in to stations of higher frequencies.

Press ◄◄◄ ▼ to tune in to stations of lower frequencies.

- If you release your finger from the button, the manual mode will automatically turn off after 5 seconds.
- If you hold down the button, the frequency keeps changing (in 50 kHz intervals (87.5 MHz – 108.0 MHz), in 30 KHz intervals (65.00 MHz – 74.00 MHz) for FM and 9 kHz intervals for AM – MW/LW) until you release the button.

Storing stations in memory

You can use one of the following two methods to store broadcasting stations in memory.

- Automatic preset of FM stations: SSM (Strong-station Sequential Memory)
- Manual preset of both FM and AM stations

FM station automatic preset: SSM

You can preset 6 local FM stations in each FM band (FM1, FM2 and FM3).

1 Select the FM band (FM1 – 3) you want to store FM stations into.

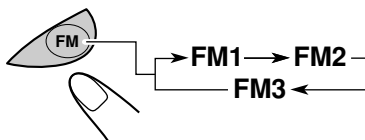

2 Press and hold both buttons for more than 2 seconds.

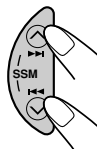

“SSM” appears, then disappears when automatic preset is over.

When an FM stereo broadcast is hard to receive:

MODE 1 Press MODE to enter the functions mode while listening to an FM stereo broadcast.



MO 2 Press MO (monaural), while still in the functions mode, so that the MO indicator lights up on the display. Each time you press the button, the MO indicator lights up and goes off alternately.



When the MO indicator is lit on the display, the sound you hear becomes monaural but the reception will be improved.

To restore the stereo effect, press the same button again.

Local FM stations with the strongest signals are searched and stored automatically in the band number you have selected (FM1, FM2 or FM3). These stations are preset in the number buttons — No.1 (lowest frequency) to No.6 (highest frequency). When automatic preset is over, the station stored in number button 1 will be automatically tuned in.

Manual preset

You can preset up to 6 stations in each band (FM1, FM2, FM3 and AM) manually.

Ex.: Storing an FM station of 88.3 MHz into the preset number 1 of the FM1 band

- 1 Select the band (FM1 – 3, AM) you want to store stations into (in this example, FM1).

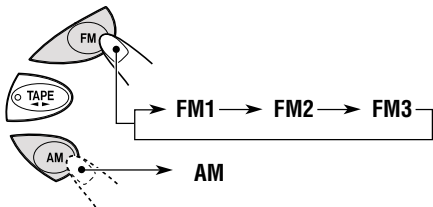

- 2 Tune in to a station (in this example, of 88.3 MHz).

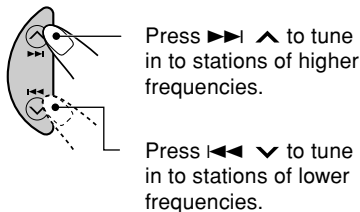

- 3 Press and hold the number button (in this example, 1) for more than 2 seconds.

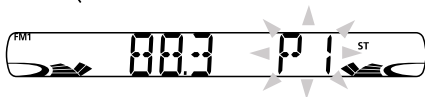
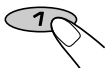

"P 1" flashes for a few seconds.

- 4 Repeat the above procedure to store other stations into other preset numbers.

Notes:

- A previously preset station is erased when a new station is stored in the same preset number.
- Preset stations are erased when the power supply to the memory circuit is interrupted (for example, during battery replacement). If this occurs, preset the stations again.

Tuning in to a preset station

You can easily tune in to a preset station. Remember that you must store stations first. If you have not stored them yet, see "Storing stations in memory" on pages 7 and 8.

- 1 Select the band (FM1 – 3, AM).

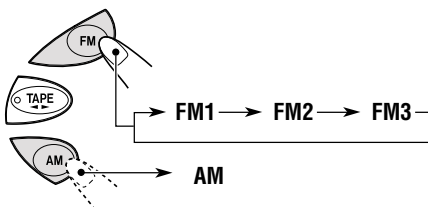

- 2 Select the number (1 – 6) for the preset station you want.

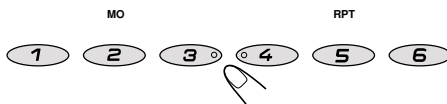

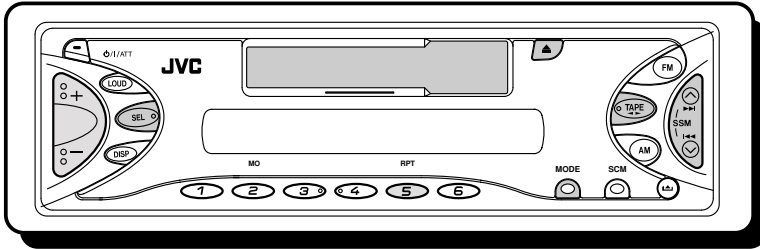

Listening to a cassette

You can play back type I (normal) tapes.

1 Insert a cassette into the cassette compartment.

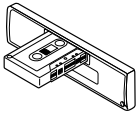

The unit turns on and tape play starts automatically. When one side of the tape reaches its end during play, the other side of the tape automatically starts playing (Auto Reverse).

Note on One-Touch Operation:

When a cassette is already in the cassette compartment, pressing TAPE ◀▶ turns on the unit and tape play starts automatically.

2 Select the tape direction.



Each time you press TAPE ◀▶, the tape direction changes alternately forward (TAPE ▶▶) and reverse (TAPE ◀◀).

To stop play and eject the cassette

Press ▲.

Tape play stops and the cassette automatically ejects from the cassette compartment. The source changes to the previously selected one. If you change the source, tape play also stops (without ejecting the cassette this time).

- You can also eject the cassette by pressing ▲ while the unit is turned off.

To fast-forward and rewind a tape

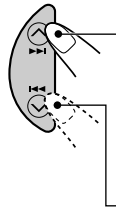

Press ▶▶▲ for more than 1 second to fast-forward the tape. When the tape reaches its end, the tape is reversed and playback starts from the beginning of the other side.

Press ◀◀▼ for more than 1 second to rewind the tape. When the tape reaches its end, playback of the same side starts.

To stop fast forward or rewind at any position on the tape, press TAPE ◀▶.

Tape play starts from that position on the tape.

Note:

When the tape reaches its end while fast-forwarding, the tape direction will be changed automatically.



Prohibiting cassette ejection

You can prohibit cassette ejection and can "lock" a cassette in the cassette compartment. While holding TAPE ◀▶, press ▲ (eject) for more than 2 seconds. "NO EJECT" flashes on the display for about 5 seconds, and the cassette is "locked."



To cancel the prohibition and "unlock" the cassette, While holding TAPE ◀▶, press ▲ (eject) for more than 2 seconds again. "EJECT OK" flashes for about 5 seconds, and this time the cassette is "unlocked."



Note:

If you press ▲ while cassette ejection is prohibited, the cassette will not be ejected.

Finding the beginning of a tune

Multi Music Scan allows you to automatically start playback from the beginning of a specified tune. You can specify up to 9 tunes ahead of or before the current tune.

During playback

Specify how many tunes ahead of or before the current tune the one you want is located.

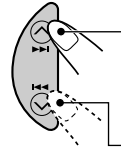

Press ▶▶| ▲ to locate a tune ahead of the current tune on the cassette.

Press ◀◀| ▼ to locate a tune before the current tune on the cassette.

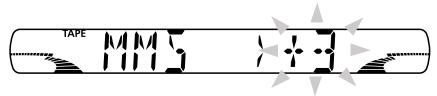

Each time you press the buttons, the number changes up to ± 9 . When the beginning of the specified tune is located, playback starts automatically.

Notes:

- While locating a specified tune:
 - If the tape is rewound to its beginning, playback starts from the beginning of that side.
 - If the tape is fast-forwarded to the end, it is reversed and played from the beginning of the other side.
- In the following cases, the Multi Music Scan function may not operate correctly:
 - Tapes with tunes having long pianissimo passages (very quiet parts) or non-recorded portions between tunes.
 - Tapes with short non-recorded sections.
 - Tapes with high level of noise or humming between tunes.



Other convenient tape functions

Skipping the blank portions on the tape

You can skip blank portions between the tunes (Blank Skip).

When this function is on, the unit skips blank portions of 15 seconds or more, fast-forwards to the next tune, then starts playing it.

- See also “Changing the general settings (PSM)” on pages 15 and 16.

- 1 Press and hold SEL (select) for more than 2 seconds so that one of the PSM items appears on the display. (PSM: see page 16.)**



- 2 Press ►► | ^ or ◀◀ | v to select “B. SKIP (blank skip).”**

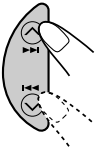

- 3 Press + to select “ON.”**
Now Blank Skip is activated.

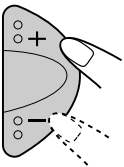

- 4 Press SEL (select) to finish the setting.**



To cancel Blank Skip, repeat the same procedure and select “OFF” in step 3 by pressing –.

Playing the current tune repeatedly

You can play the current tune repeatedly (Repeat Play).

To play back tracks repeatedly (Repeat Play)

- 1 Press MODE to enter the functions mode while playing a tune. This unit enters the functions mode.**



RPT



- 2 Press RPT (Repeat), while still in the functions mode, so that the RPT indicator lights up on the display. Then, each time you press the button, repeat play mode turns on and off alternately.**

Lights up when Repeat Play is turned on.



When the repeat mode is turned on, the RPT indicator lights up on the display.

Note:

In the following cases, Blank Skip and Repeat Play may not operate correctly:

- Tapes with tunes having long pianissimo passages (very quiet parts) or non-recorded portions during tunes.
- Tapes with short non-recorded sections.
- Tapes with high level noise or humming between tunes.
- Tapes with tunes recorded at low recording levels.



SOUND ADJUSTMENTS

ENGLISH

Adjusting the sound

You can adjust the sound characteristics to your preference.

1 Select the item you want to adjust.



Each time you press the button, the adjustable items change as follows:

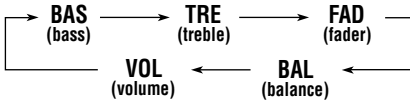

2 Adjust the level.

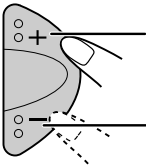

To increase the level.

To decrease the level.

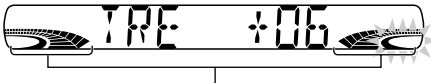

Equalization pattern changes as you adjust the bass or treble.

Ex.: When you adjust "TRE" (treble)

Note:

Normally, the +/- buttons works as the volume control buttons. So you do not have to select "VOL" to adjust the volume level.

Indication	To do:	Range
BAS	Adjust the bass.	-06 (min.) +06 (max.)
TRE	Adjust the treble.	-06 (min.) +06 (max.)
FAD*	Adjust the front and rear speaker balance.	R06 (Rear only) F06 (Front only)
BAL	Adjust the left and right speaker balance.	L06 (Left only) R06 (Right only)
VOL	Adjust the volume.	00 (min.) 50 (max.)

* If you are using a two-speaker system, set the fader level to "00".



Turning on/off the loudness function

The human ear is less sensitive to low and high frequencies at low volumes.

The loudness function can boost these frequencies to produce a well-balanced sound at low volume levels.

Each time you press LOUD, the loudness function turns on and off alternately.

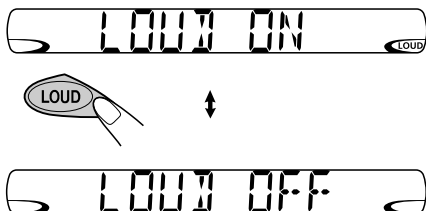

Selecting preset sound modes

You can select a preset sound adjustment suitable to the music genre.

Each time you press SCM, the sound mode changes as follows:



Indication	For	Preset values		
		BAS	TRE	LOUD
SCM OFF	(Flat sound)	00	00	OFF
BEAT	Rock or disco music	+02	00	ON
SOFT	Quiet background music	+01	-03	OFF
POP	Light music	+04	+01	OFF

Notes:

- You can adjust the preset sound mode to your preference, and store it in memory. If you want to adjust and store your original sound mode, see "Storing your own sound adjustments" on page 14.
- To adjust only the bass and treble reinforcement levels to your preference, see "Adjusting the sound" on page 12.
- When one of the sound modes is selected, it is shown on the display as follows:



For example, when "POP" is selected.



Storing your own sound adjustments

You can adjust the sound modes (BEAT, SOFT, POP) to your preference and store your own adjustments in memory.

- There is a time limit in doing the following procedure. If the setting is canceled before you finish, start from step 1 again.

1 Call up the sound mode you want to adjust.

SCM • See pages 13 for details.

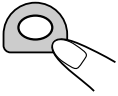

2 To adjust the bass or treble level.

Select "BAS" or "TRE".

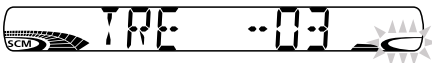

Ex.: When you select "TRE (treble)"

3 Adjust the bass or treble level.

• See pages 12 for details.

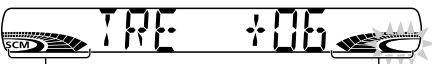
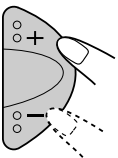

Equalization pattern changes as you adjust the bass or treble.

Ex.: When you adjust "TRE" (treble)

4 Repeat step 2 and 3 to adjust the other items.

5 To turn on or off the loudness function.



• See pages 13 for details.

6 Press and hold SCM until the sound mode you have selected in step 1 flashes on the display.

SCM



Your adjustment made for the selected sound mode is stored in memory.

7 Repeat the same procedure to store other sound modes.

To reset to the factory settings

Repeat the same procedure and reassign the preset values listed in the table on page 13.

Setting the clock

- 1 Press and hold SEL (select) for more than 2 seconds so that one of the PSM items appears on the display. (See page 16.)



- 2 Set the hour.

- 1 Select "CLOCK H (hour)" if not shown on the display.
- 2 Adjust the hour.

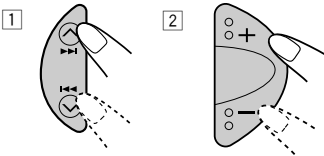

- 3 Set the minute.

- 1 Select "CLOCK M (minute)."
- 2 Adjust the minute.

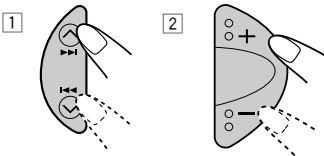

- 4 Press SEL (select) to finish the setting.



To check the current clock time or change the display mode

Press DISP (display) repeatedly. Each time you press the button, the display mode changes as follows:

During tuner operation:

Frequency \longleftrightarrow Clock

During tape operation:

Play mode (tape direction) \longleftrightarrow Clock

During power off:

The power turns on, the clock time is shown for 5 seconds, then the power turns off.

Changing the general settings (PSM)

You can change the items listed on the next page by using the PSM (Preferred Setting Mode) control.

Basic Procedure

- 1 Press and hold SEL (select) for more than 2 seconds so that one of the PSM items appears on the display. (See page 16.)



- 2 Select the PSM item you want to adjust. (See page 16.)

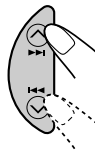

CONTINUED ON THE NEXT PAGE

3 Adjust the PSM item selected.

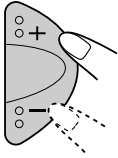

4 Repeat steps 2 and 3 to adjust the other PSM items if necessary.

5 Press SEL (select) to finish the setting.

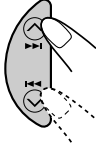
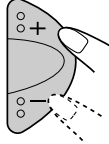

Preferred Setting Mode (PSM) items

1	2	3		Factory-preset settings	See page
 Hold...	 Select...	Set...  - +			
CLOCK H	Hour adjustment	Back	Advance	0:00	15
CLOCK M	Minute adjustment	Back	Advance		
LEVEL	Level display	AUDIO 1 ↔ AUDIO 2 ↕ ↕ OFF		AUDIO 2	16
TEL	Telephone muting	OFF ↔ MUTING 1 ↕ ↕ MUTING 2		OFF	16
B. SKIP	Blank skip	OFF	ON	OFF	11

• Press SEL (select) to finish the setting.

To select the level meter – LEVEL

You can select the level display according to your preference.

When shipped from the factory, "AUDIO 2" is selected.

- AUDIO 1: Level meter illuminates from bottom to top.
- AUDIO 2: Alternates level meter (moves from bottom to top) and illumination display.
- OFF: Erases the audio level indicator.

To select the telephone muting – TEL

This mode is used when a cellular phone system is connected. Depending on the phone system used, select either "MUTING 1" or "MUTING 2," whichever mutes the sounds from this unit.

When shipped from the factory, this mode is deactivated.

- MUTING 1: Select this if this setting can mute the sounds.
- MUTING 2: Select this if this setting can mute the sounds.
- OFF: Cancels the telephone muting.

Detaching the control panel

You can detach the control panel when leaving the car.

When detaching or attaching the control panel, be careful not to damage the connectors on the back of the control panel and on the panel holder.

Detaching the control panel

Before detaching the control panel, be sure to turn off the power.

- 1 Unlock the control panel.

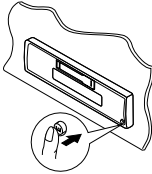

- 2 Lift and pull the control panel out of the unit.

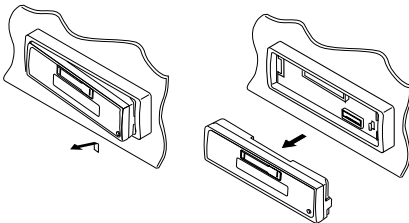

- 3 Put the detached control panel into the provided case.

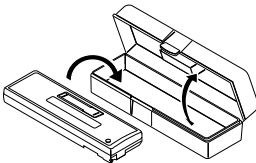

Attaching the control panel

- 1 Insert the left side of the control panel into the groove on the panel holder.

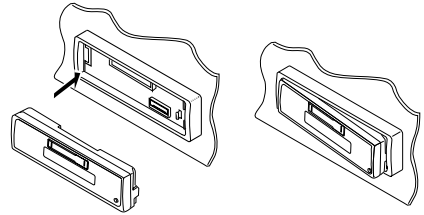

- 2 Press the right side of the control panel to fix it to the panel holder.

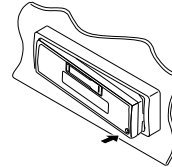

Note on cleaning the connectors:

If you frequently detach the control panel, the connectors will deteriorate.

To minimize this possibility, periodically wipe the connectors with a cotton swab or cloth moistened with alcohol, being careful not to damage the connectors.

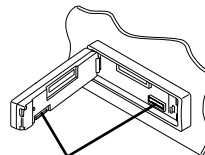

Connectors



TROUBLESHOOTING

ENGLISH

What appears to be trouble is not always serious. Check the following points before calling a service center.

Symptoms	Causes	Remedies
• A cassette tape cannot be inserted.	You have tried to insert a cassette in the wrong way.	Insert the cassette with the exposed tape facing right.
• A cassette tape cannot be ejected.	Cassette ejection is prohibited.	While holding TAPE ◀▶, press ▲ (eject) for more than 2 seconds.
• Cassette tapes become hot.	This is not a malfunction.	_____
• Tape sound is at very low level and sound quality is degraded.	The tape head is dirty.	Clean it with a head cleaning tape.
• Sound is sometimes interrupted.	Connections are not good.	Check the cords and connections.
• Sound cannot be heard from the speakers.	The volume is turned to the minimum level.	Adjust it to the optimum level.
	Connections are incorrect.	Check the cords and connections.
• SSM (Strong-station Sequential Memory) automatic preset does not work.	Signals are too weak.	Store stations manually.
• Static noise while listening to the radio.	The aerial is not connected firmly.	Connect the aerial firmly.
• This unit does not work at all.	The built-in microcomputer may function incorrectly due to noise, etc.	While holding SEL (select), press ⏻/I/ATT (standby/on/attenuator) for more than 2 seconds. (The clock setting and preset stations stored in memory are erased.) (See page 2.)



This unit requires very little attention, but you will be able to extend the life of the unit if you follow the instructions below.

To clean the head

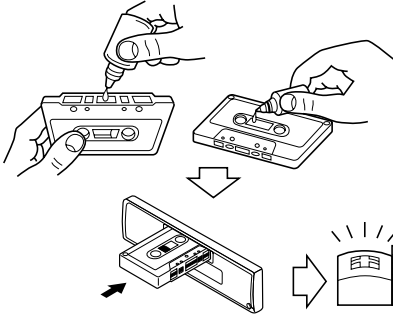

- Clean the head after every 10 hours of use using a wet-type head cleaning tape (available at an audio store).
When the head becomes dirty, you may realize the following symptoms:
 - Sound quality is reduced.
 - Sound level decreases.
 - Sound drops out.
- Do not play dirty or dusty tapes.
- Do not touch the highly-polished head with any metallic or magnetic tools.

To keep the tape clean

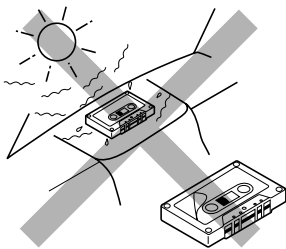

- Always store the cassettes in their storage cases after use.
- Do not store cassettes in the following places:
 - Subject to direct sunlight
 - With high humidity
 - At extremely hot temperatures

CAUTION:

- Do not play the cassettes with peeling labels; otherwise, they can damage the unit.
- Tighten tapes to remove slack since loose tape may become entangled with the mechanism.
- Do not leave a cassette in the cassette compartment after use, as the tape may become slack.

The function below is also provided to ensure the longer life of this unit.

Ignition key-off release/ Ignition key-on play

- Turning off the ignition key with a cassette in the compartment automatically releases the tape from the unit's tapehead.
- Turning on the ignition key with a cassette in the compartment starts playback automatically if you turned off the ignition during tape play.

SPECIFICATIONS

AUDIO AMPLIFIER SECTION

Maximum Power Output:

Front: 45 W per channel

Rear: 45 W per channel

Continuous Power Output (RMS):

Front: 17 W per channel into 4 Ω , 40 Hz
to 20 000 Hz at no more than
0.8% total harmonic distortion.

Rear: 17 W per channel into 4 Ω , 40 Hz
to 20 000 Hz at no more than
0.8% total harmonic distortion.

Load Impedance: 4 Ω (4 Ω to 8 Ω allowance)

Tone Control Range:

Bass: ± 10 dB at 100 Hz

Treble: ± 10 dB at 10 kHz

Frequency Response: 40 Hz to 20 000 Hz

Signal-to-Noise Ratio: 70 dB

Line-Out Level/Impedance:

1.0V/20 k Ω load (250 nWb/m)

TUNER SECTION

Frequency Range:

FM1/FM2: 87.5 MHz to 108.0 MHz

FM3: 65.00 MHz to 74.00 MHz

AM: (MW) 522 kHz to 1 620 kHz
(LW) 144 kHz to 279 kHz

[FM Tuner]

Usable Sensitivity: 11.3 dBf (1.0 μ V/75 Ω)

50 dB Quieting Sensitivity:

16.3 dBf (1.8 μ V/75 Ω)

Alternate Channel Selectivity (400 kHz):

65 dB

Frequency Response: 40 Hz to 15 000 Hz

Stereo Separation: 30 dB

Capture Ratio: 1.5 dB

[MW Tuner]

Sensitivity: 20 μ V

Selectivity: 35 dB

[LW Tuner]

Sensitivity: 50 μ V

CASSETTE DECK SECTION

Wow & Flutter: 0.11% (WRMS)

Fast-Wind Time: 100 sec. (C-60)

Frequency Response:

30 Hz to 16 000 Hz (Normal tape)

Signal-to-Noise Ratio: (Normal tape): 56 dB

Stereo Separation: 40 dB

GENERAL

Power Requirement:

Operating Voltage: DC 14.4 V

(11 V to 16 V allowance)

Grounding System: Negative ground

Allowable Operating Temperature: 0°C to +40°C

Dimensions (W \times H \times D):

Installation Size: 182 mm \times 52 mm \times 150 mm

Panel Size: 188 mm \times 58 mm \times 11 mm

Mass: 1.3 kg (excluding accessories)

*Design and specifications are subject to change
without notice.*

**Having TROUBLE with operation?
Please reset your unit**

Refer to page of How to reset your unit

**Затруднения при эксплуатации?
Пожалуйста, перезагрузите Ваше устройство**
Для получения информации о перезагрузке Вашего устройства
обратитесь на соответствующую страницу

JVC
VICTOR COMPANY OF JAPAN, LIMITED

 EN, RU

© 2002 VICTOR COMPANY OF JAPAN, LIMITED

 1202KKSFLEJEIN

Download from Www.Somanuals.com. All Manuals Search And Download.

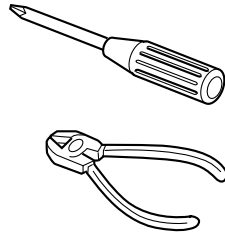

ENGLISH

- This unit is designed to operate on 12 V DC, NEGATIVE ground electrical systems.

INSTALLATION (IN-DASH MOUNTING)

- The following illustration shows a typical installation. However, you should make adjustments corresponding to your specific car. If you have any questions or require information regarding installation kits, consult your JVC IN-CAR ENTERTAINMENT dealer or a company supplying kits.

1 Before mounting: Press (Control Panel Release button) to detach the control panel if already attached.

* When shipped from the factory, the control panel is packed in the hard case.

2 Remove the trim plate.

3 Remove the sleeve after disengaging the sleeve locks.

① Stand the unit.

Note: When you stand the unit, be careful not to damage the fuse on the rear.

② Insert the 2 handles between the unit and the sleeve, as illustrated, to disengage the sleeve locks.

③ Remove the sleeve.

Note: Be sure to keep the handles for future use after installing the unit.

4 Install the sleeve into the dashboard.

* After the sleeve is correctly installed into the dashboard, bend the appropriate tabs to hold the sleeve firmly in place, as illustrated.

5 Fix the mounting bolt to the rear of the unit's body and place the rubber cushion over the end of the bolt.

6 Do the required electrical connections.

7 Slide the unit into the sleeve until it is locked.

8 Attach the trim plate.

9 Attach the control panel.

РУССКИЙ

- Это устройство разработано для эксплуатации на 12 В постоянного напряжения с минусом на массе.

УСТАНОВКА (УСТАНОВКА В ПРИБОРНУЮ ПАНЕЛЬ)

- На следующих иллюстрациях показана типовая установка. Тем не менее, Вы должны сделать поправки в соответствии с типом Вашего автомобиля. Если у Вас есть какие-либо вопросы, касающиеся установки, обратитесь к Вашему дилеру JVC IN-CAR ENTERTAINMENT или в компанию, поставляющую соответствующие принадлежности.

1 Перед установкой: Нажмите кнопку (кнопка освобождения панели управления) для отсоединения панели управления, если она уже прикреплена.

* При отправке с завода панель управления упакована в твердую коробку.

2 Удалите декоративную панель.

3 Удалите муфту после освобождения запоров муфты.

① Установите устройство.

Примечание: Устанавливайте устройство таким образом, чтобы не повредить предохранитель, расположенный сзади.

② Вставьте два рычага между устройством и муфтой, как показано на рисунке, для освобождения запоров муфты.

③ Удалите муфту.

Примечание: После установки устройства сохраните рычаги для использования в будущем.

4 Установите муфту в приборную панель.

* После установки муфты в приборную панель согните соответствующие зубцы для фиксации муфты, как показано на рисунке.

5 Затяните фиксирующий болт на задней части корпуса устройства и наденьте резиновый чехол на конец болта.

6 Выполните необходимые подключения контактов, как показано на обратной стороне этой инструкции.

7 Задвиньте устройство в муфту до упора.

8 Прикрепите декоративную панель.

9 Прикрепите панель управления.

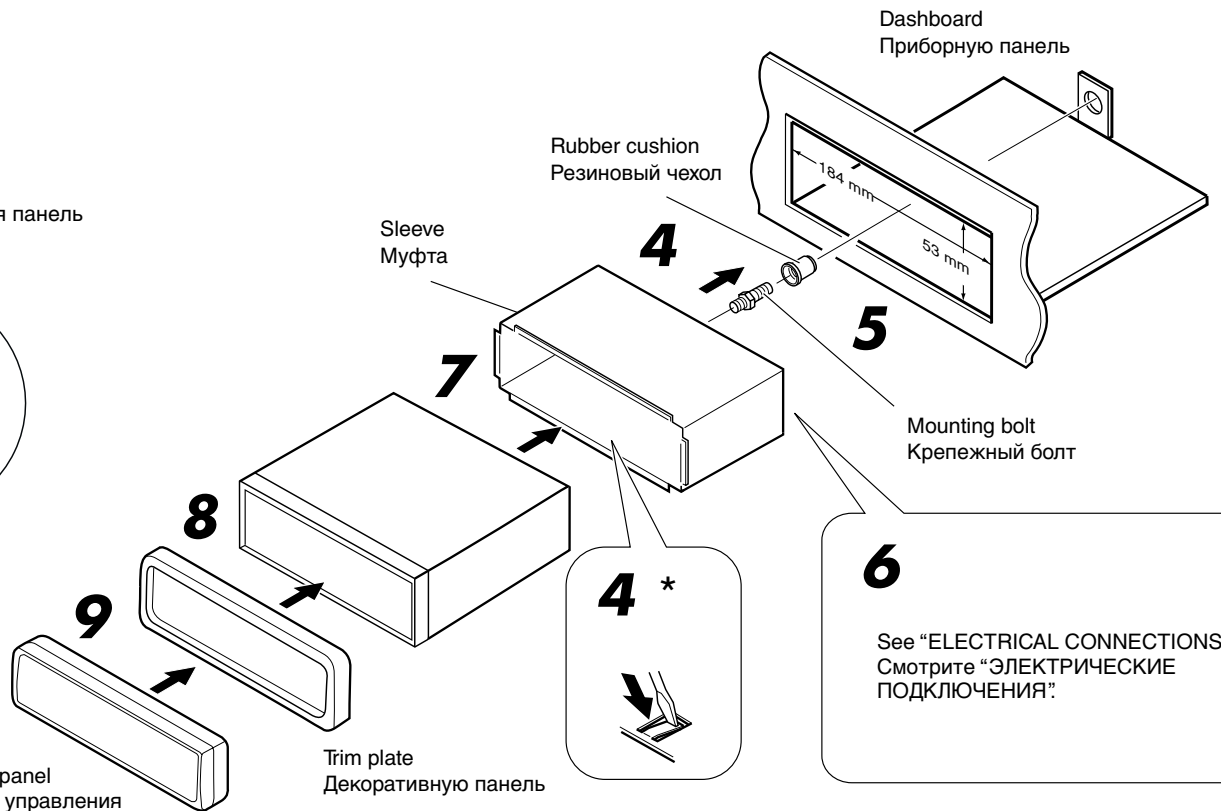
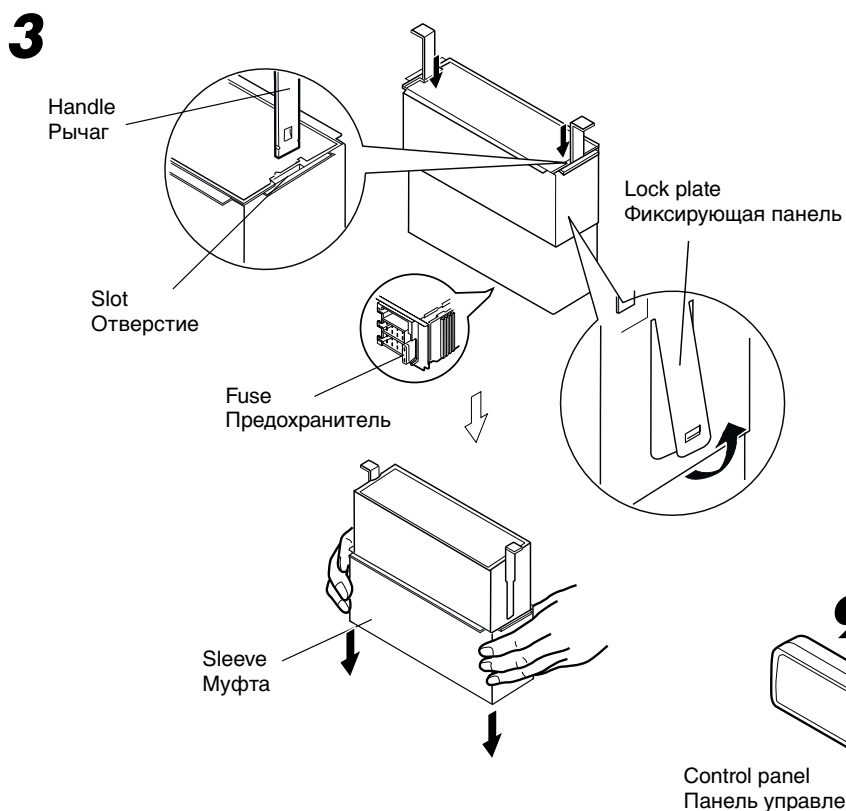
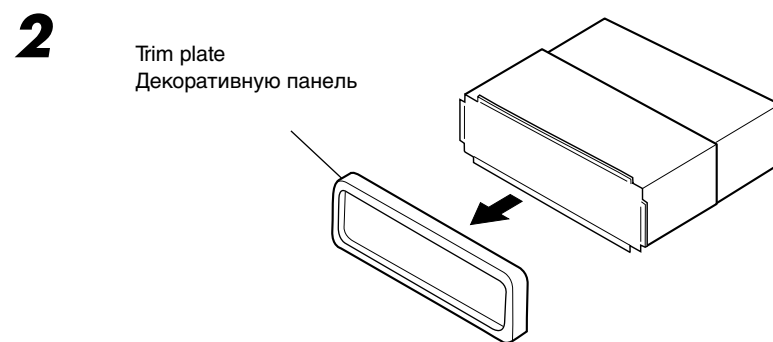
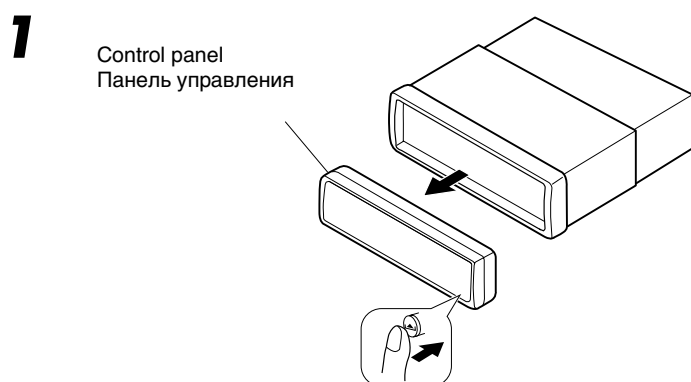

- When using the optional stay
- При использовании дополнительной стойки

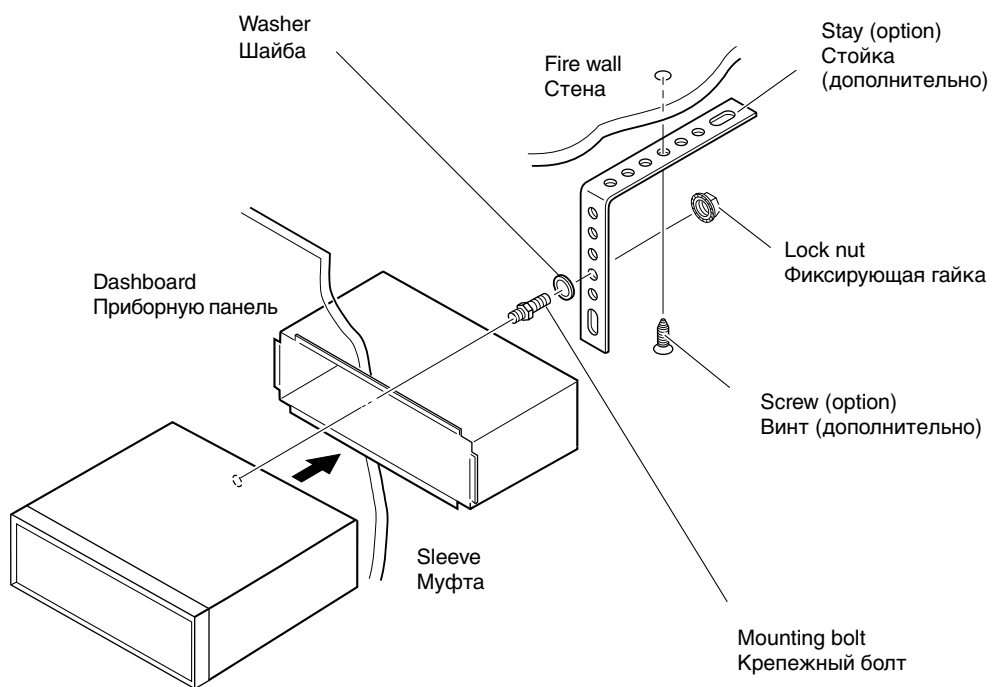

Less than 30°
Менее 30°

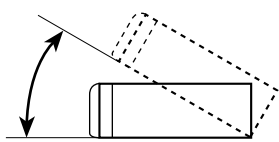

Install the unit at an angle of less than 30°.
Установите устройство под углом менее 30°.

- When installing the unit without using the sleeve
- При установке устройства без использования муфты

In a Toyota for example, first remove the car radio and install the unit in its place.
В Тойоте, например, сначала удалите автомобильную магнитолу, затем установите на ее место это устройство.

Flat type screws (M5 x 6 mm)*
Крепежные винты (M5 x 6 мм)*

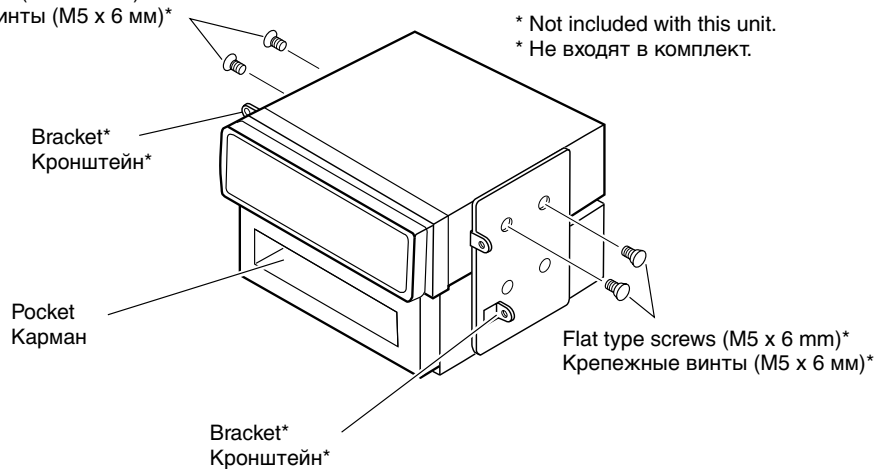

* Not included with this unit.
* Не входят в комплект.

Note: When installing the unit on the mounting bracket, make sure to use the 6 mm-long screws. If longer screws are used, they could damage the unit.

Примечание: При установке устройства на крепежный кронштейн, используйте только винты длиной 6 мм. При использовании более длинных винтов, можно повредить устройство.

Removing the unit

- Before removing the unit, release the rear section.

- 1 Remove the control panel.
- 2 Remove the trim plate.
- 3 Insert the 2 handles into the slots, as shown. Then, while gently pulling the handles away from each other, slide out the unit. **(Be sure to keep the handles after installing it.)**

Удаление устройства

- Перед удалением устройства освободите заднюю часть.

- 1 Удалите панель управления.
- 2 Удалите декоративную панель.
- 3 Вставьте 2 рычага в отверстия, как показано на иллюстрации. Затем, плавно раздвигая рычаги в стороны, выньте устройство. **(После установки сохраните рычаги.)**

1

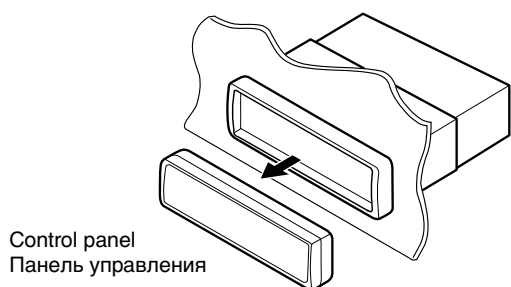

Control panel
Панель управления

2

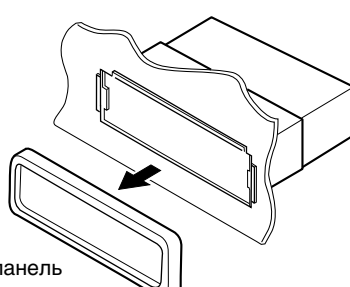

Trim plate
Декоративную панель

3

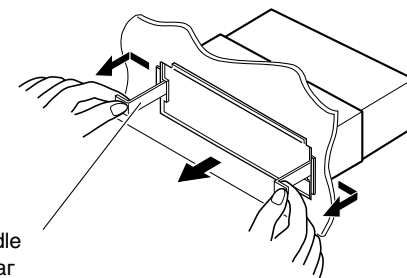

Handle
Рычаг

Parts list for installation and connection

The following parts are provided with this unit.
After checking them, please set them correctly.

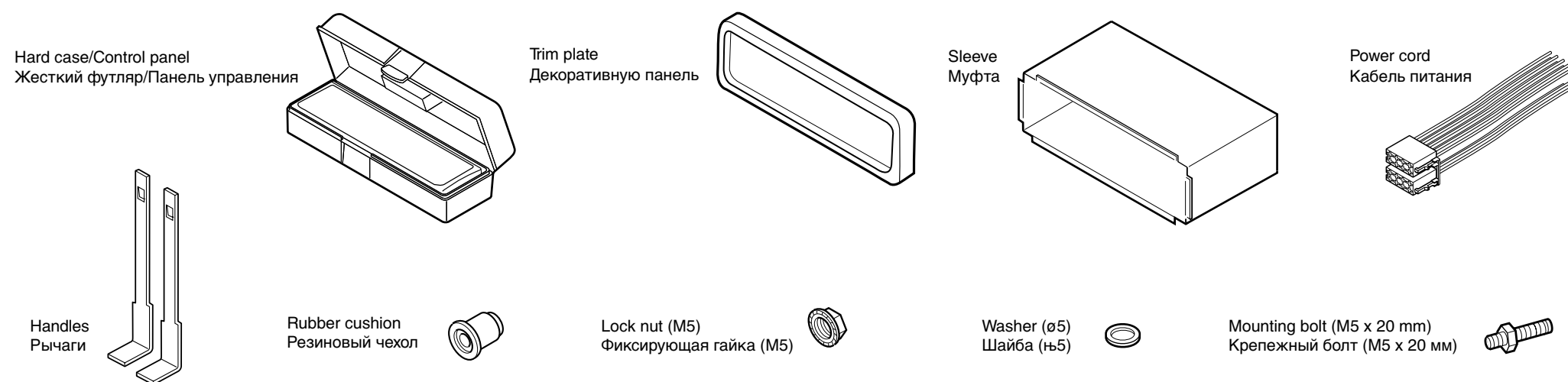

Список деталей для установки и подключения

Следующие детали поставлены в комплекте с устройством.
После проверки комплектации, пожалуйста, установите их правильно.

TROUBLESHOOTING

- **The fuse blows.**
* Are the red and black leads connected correctly?
- **Power cannot be turned on.**
* Is the yellow lead connected?
- **No sound from the speakers.**
* Is the speaker output lead short-circuited?
- **Sound is distorted.**
* Is the speaker output lead grounded?
* Are the “-” terminals of L and R speakers grounded in common?
- **Unit becomes hot.**
* Is the speaker output lead grounded?
* Are the “-” terminals of L and R speakers grounded in common?

ВЫЯВЛЕНИЕ НЕИСПРАВНОСТЕЙ

- **Сработал предохранитель.**
* Правильно ли подключены черный и красный провода?
- **Питание не включается.**
* Подключен ли желтый провод?
- **Звук не выводится через громкоговорители.**
* Нет ли короткого замыкания на кабеле выхода громкоговорителей?
- **Звук искажен.**
* Заземлен ли провод выхода громкоговорителей?
* Заземлены ли разъемы “-” правого (R) и левого (L) громкоговорителей?
- **Устройство нагревается.**
* Заземлен ли провод выхода громкоговорителей?
* Заземлены ли разъемы “-” правого (R) и левого (L) громкоговорителей?

ELECTRICAL CONNECTIONS

To prevent short circuits, we recommend that you disconnect the battery's negative terminal and make all electrical connections before installing the unit. If you are not sure how to install this unit correctly, have it installed by a qualified technician.

Note:

This unit is designed to operate on **12 V DC, NEGATIVE ground electrical systems**. If your vehicle does not have this system, a voltage inverter is required, which can be purchased at JVC IN-CAR ENTERTAINMENT dealers.

- Replace the fuse with one of the specified rating. If the fuse blows frequently, consult your JVC IN-CAR ENTERTAINMENT dealer.
- If noise is a problem...
This unit incorporates a noise filter in the power circuit. However, with some vehicles, clicking or other unwanted noise may occur. If this happens, connect the unit's **rear ground terminal** (See connection diagram.) to the car's chassis using shorter and thicker cords, such as copper braiding or gauge wire. If noise still persists, consult your JVC IN-CAR ENTERTAINMENT dealer.
- Maximum input of the speakers should be more than 45 W at the rear and 45 W at the front with an impedance of **4 Ω to 8 Ω**.
- **Be sure to ground this unit to the car's chassis.**
- The heat sink becomes very hot after use. Be careful not to touch it when removing this unit.

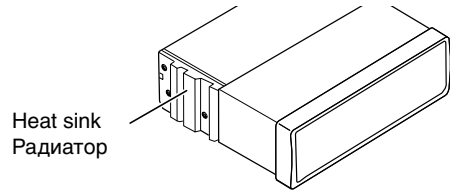

A Typical Connections / Типичные подключения

Before connecting: Check the wiring in the vehicle carefully. Incorrect connection may cause serious damage to this unit. The leads of the power cord and those of the connector from the car body may be different in color.

1 Connect the colored leads of the power cord to the car battery, speakers and power aerial (if any) in the following sequence.

- ① Black: ground
- ② Yellow: to car battery (constant 12 V)
- ③ Red: to an accessory terminal
- ④ Blue with white stripe: to power aerial (200 mA max.)
- ⑤ Brown: to cellular phone system (For details, refer to the instructions of the cellular phone.)
- ⑥ Others: to speakers

2 Connect the aerial cord.

3 Finally connect the wiring harness to the unit.

Note: If your vehicle does not have any accessory terminal, move the fuse from the fuse position 1 (initial position) to fuse position 2, and connect the red lead (A7) to the positive (+) battery terminal.

- The yellow lead (A4) is not used in this case.

ЭЛЕКТРИЧЕСКИЕ ПОДКЛЮЧЕНИЯ

Для предотвращения коротких замыканий мы рекомендуем Вам отсоединить отрицательный разъем аккумулятора и осуществить все подключения перед установкой устройства. Если Вы не знаете точно, как следует устанавливать это устройство, обратитесь к квалифицированному специалисту.

Примечание:

Это устройство разработано для эксплуатации на **12 В постоянного напряжения с минусом на массе**. Если Ваш автомобиль не имеет этой системы, требуется инвертор напряжения, который может быть приобретен у дилера JVC IN-CAR ENTERTAINMENT.

- Заменяйте предохранитель другим предохранителем указанного класса. Если предохранитель сгорает слишком часто, обратитесь к дилеру JVC IN-CAR ENTERTAINMENT.
- При появлении сильных помех...
Это устройство оснащено фильтром помех в цепи питания. Однако, в некоторых случаях возможно появление щелчков и других нежелательных помех. В этом случае подключите **задний разъем заземления** этого устройства (см. схему подключения) к шасси автомобиля при помощи более коротких и толстых проводов. Если помехи не исчезают, обратитесь к дилеру JVC IN-CAR ENTERTAINMENT.
- Максимальная входная мощность громкоговорителей должна быть больше 45 Вт сзади и 45 Вт впереди при полном сопротивлении от **4 Ω до 8 Ω**.
- **Не забудьте заземлить устройство на шасси автомобиля.**
- Радиатор во время использования сильно нагревается. Старайтесь его не трогать во время удаления устройства.

Перед соединением: Тщательно проверьте электропроводку в автомобиле. Неправильное подключение может привести к серьезному повреждению данного устройства. Жилы силового кабеля и жилы соединителя от кузова автомобиля могут быть разного цвета.

1 Подключите цветные провода кабеля питания к аккумулятору, громкоговорителям и автономной антенне (если есть) в следующем порядке:

- ① Черный: земля
- ② Желтый: к аккумулятору (постоянный 12 В)
- ③ Красный: к вспомогательному разъему
- ④ Синий с белой полосой: к питанию антенны (максимум 200 мА).
- ⑤ Коричневый: к системе сотового телефона (Детали смотрите в инструкции сотового телефона.)
- ⑥ Другие: к громкоговорителям

2 Подключите кабель антенны.

3 В последнюю очередь подключите электропроводку к устройству.

Примечание: Если в Вашем автомобиле никакого вспомогательного разъема не имеется, переставьте предохранитель из положения 1 предохранителя (первоначальное положение) в положение 2 предохранителя и подключите красный провод (A7) к положительному (+) полюсу аккумулятора.

- Желтый провод (A4) в этом случае не используется.

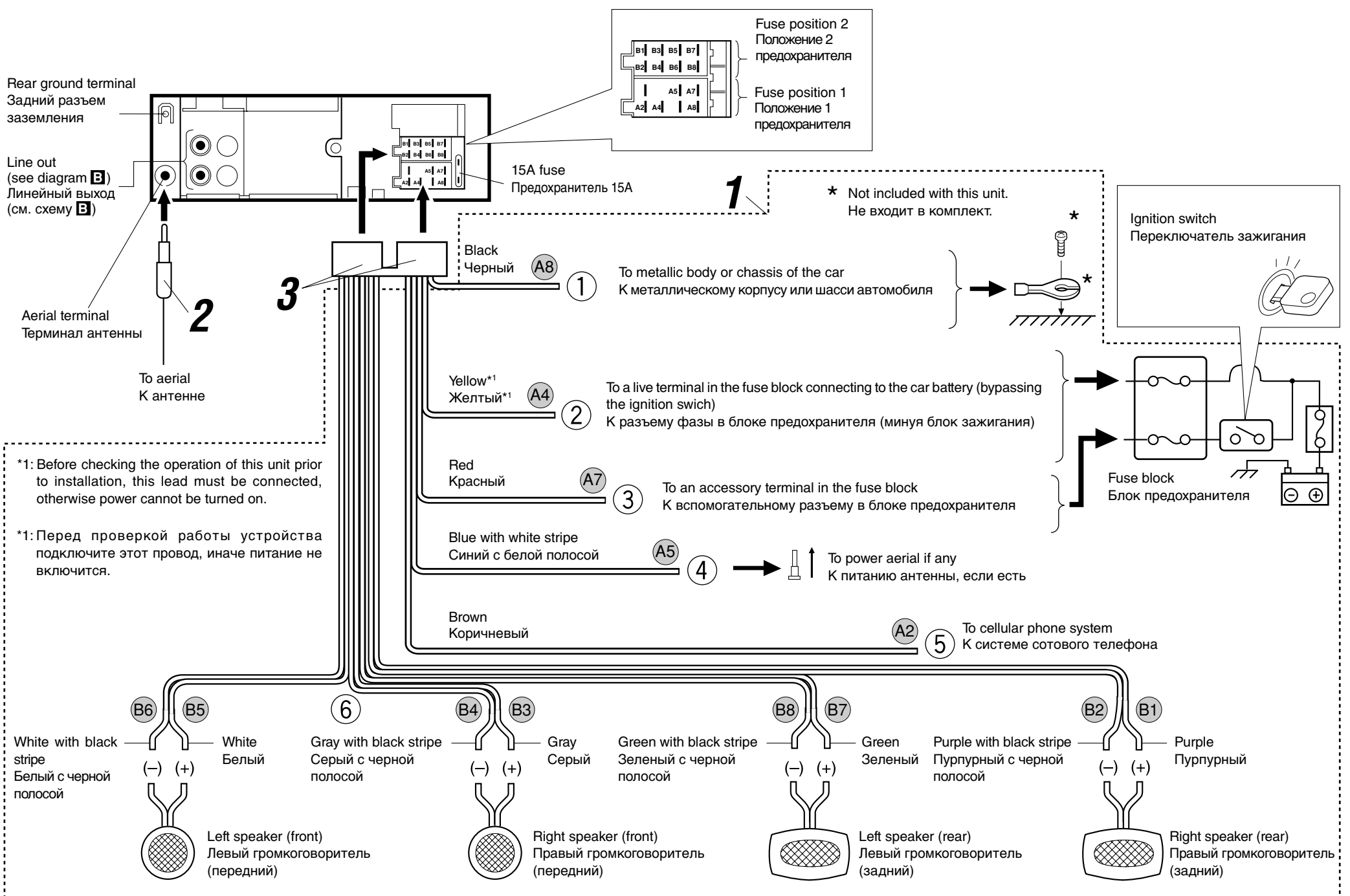

PRECAUTIONS on power supply and speaker connections:

- **DO NOT connect the speaker leads of the power cord to the car battery; otherwise, the unit will be seriously damaged.**
- Connect the black lead (ground), yellow lead (to car battery, constant 12V), and red lead (to an accessory terminal) correctly.
- **BEFORE** connecting the speaker leads of the power cord to the speakers, check the speaker wiring in your car.
 - **If the speaker wiring in your car is as illustrated in Fig. 1 and Fig. 2 below, DO NOT connect the unit using that original speaker wiring. If you do, the unit will be seriously damaged. Redo the speaker wiring so that you can connect the unit to the speakers as illustrated in Fig. 3.**
 - **If the speaker wiring in your car is as illustrated in Fig. 3, you can connect the unit using the original speaker wiring in your car.**
 - If you are not sure of the speaker wiring of your car, consult your car dealer.

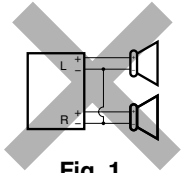

Fig. 1

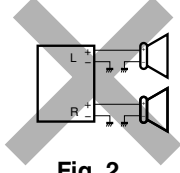

Fig. 2

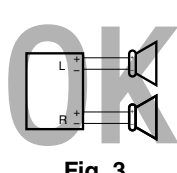

Fig. 3

ПРЕДОСТЕРЕЖЕНИЯ по питанию и подключению громкоговорителей:

- **НЕ подключайте провода громкоговорителей к аккумулятору автомобиля, иначе устройство будет повреждено.**
- Правильно подключите черный провод (земля), желтый провод (в аккумулятор, постоянный 12 В) и красный провод (в вспомогательный разъем).
- **ПЕРЕД** подключением проводов громкоговорителей к кабелю питания громкоговорителя проверьте схему соединений громкоговорителей в Вашем автомобиле.
 - **Если проводка громкоговорителей в Вашем автомобиле такая, как показано на приводимых ниже Fig. 1 и Fig. 2, НЕ подключайте устройство с помощью первоначальной проводки громкоговорителей. Если Вы это сделаете, устройство будет серьезно повреждено. Переделайте проводку громкоговорителей так, чтобы Вы могли подключить устройство к громкоговорителям, как это показано на рис. 3.**
 - **Если проводка громкоговорителей в Вашем автомобиле такая, как показано на Fig. 3, Вы можете подключить устройство с помощью первоначальной проводки громкоговорителей в Вашем автомобиле.**
 - Если Вы не знаете соединение громкоговорителей в Вашем автомобиле, обратитесь к Вашему автомобильному дилеру.

Connecting the leads / Подключение контактов

Twist the core wires when connecting.

Закрутите концы проводов при соединении.

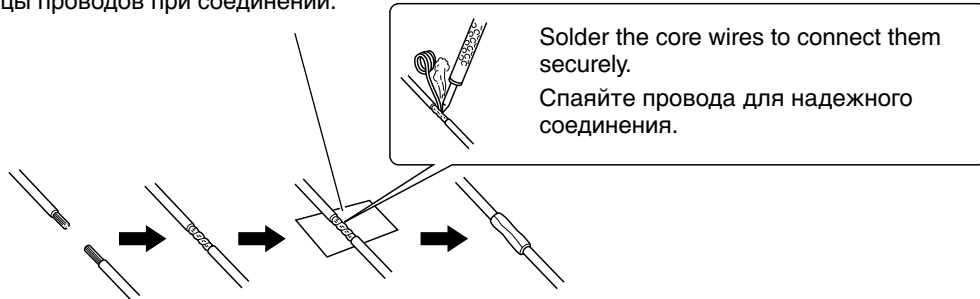

Solder the core wires to connect them securely.
Спаяйте провода для надежного соединения.

CAUTION / ПРЕДОСТЕРЕЖЕНИЕ:

- To prevent short-circuit, cover the terminals of the UNUSED leads with insulating tape.
- Для предотвращения короткого замыкания заклейте неиспользуемые концы изолирующей лентой.

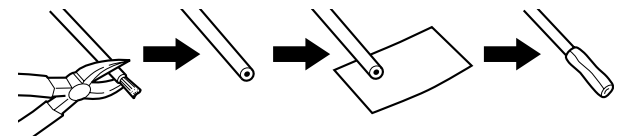

B Connections Adding Other Equipment / Подключение других устройств

Amplifier / Усилитель

You can connect an amplifier and other equipment to upgrade your car stereo system.

- Connect the remote lead (blue with white stripe) to the remote lead of the other equipment so that it can be controlled through this unit.
- For amplifier only:
 - Connect this unit's line-out terminals to the amplifier's line-in terminals.
 - **Disconnect the speakers from this unit, connect them to the amplifier. Leave the speaker leads of this unit unused. (Cover the terminals of these unused leads with insulating tape, as illustrated above.)**

Вы можете подключить усилитель и другое оборудование для модернизации стереосистемы в Вашем автомобиле.

- Подсоедините провод внешнего устройства (синий с белой полосой) к проводу внешнего устройства другого оборудования так, чтобы им можно было управлять с этого устройства.
- Только для усилителя:
 - Подключите выходные клеммы данного устройства к входным клеммам усилителя.
 - **Отсоедините громкоговорители от данного устройства, подключите их к усилителю. Оставьте провода громкоговорителей данного устройства неиспользованными. (Замотайте клеммы этих неиспользованных проводов изоляционной лентой, как показано выше.)**

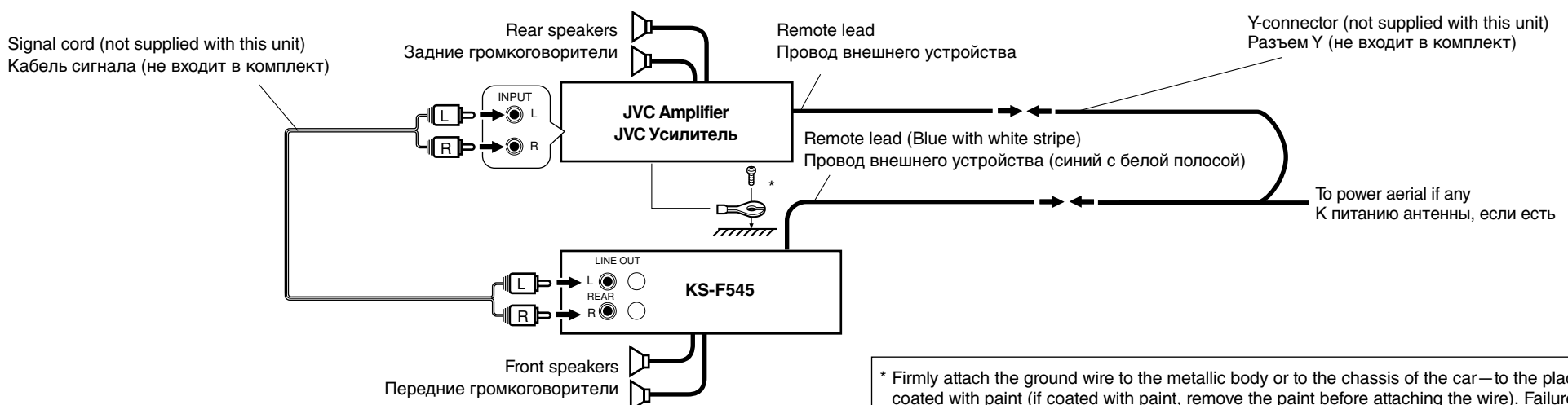

- * Firmly attach the ground wire to the metallic body or to the chassis of the car—to the place not coated with paint (if coated with paint, remove the paint before attaching the wire). Failure to do so may cause damage to this unit.
- * Плотно прикрепите заземляющий провод к металлическому кузову или шасси автомобиля—в месте, не покрытом краской (если оно покрыто краской, удалите краску перед тем, как прикреплять провод). Невыполнение этого требования может привести к повреждению данного устройства.

Free Manuals Download Website

<http://myh66.com>

<http://usermanuals.us>

<http://www.somanuals.com>

<http://www.4manuals.cc>

<http://www.manual-lib.com>

<http://www.404manual.com>

<http://www.luxmanual.com>

<http://aubethermostatmanual.com>

Golf course search by state

<http://golfingnear.com>

Email search by domain

<http://emailbydomain.com>

Auto manuals search

<http://auto.somanuals.com>

TV manuals search

<http://tv.somanuals.com>