

JVC

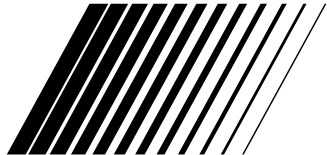

ENGLISH

CASSETTE RECEIVER

KS-FX201

卡座收音組合機

KS-FX201

中
文

วิทยุเครื่องเล่นเทป

KS-FX201

ไทย

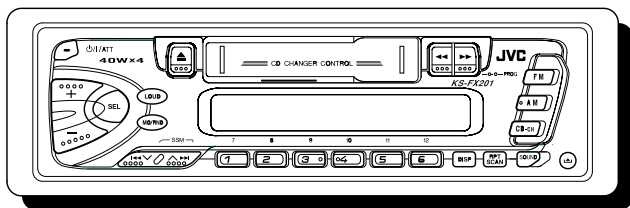
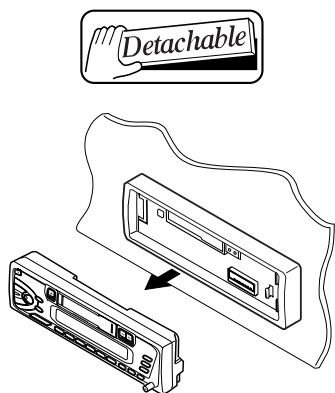

For installation and connections, refer to the separate manual.

有關安裝和連接方法，分別參見操作手冊。

กรุณาดูคู่มือที่แยกต่างหาก ในการติดตั้งและการเชื่อมต่อ







INSTRUCTIONS

使用說明書
คำแนะนำ

GET0023-001A
[U]

Thank you for purchasing a JVC product. Please read all instructions carefully before operation, to ensure your complete understanding and to obtain the best possible performance from the unit.

CONTENTS

BASIC OPERATIONS	3	
RADIO OPERATIONS	4	
Listening to the radio	4	
Storing stations in memory	5	
FM station automatic preset: SSM	5	
Manual preset	6	
Tuning into a preset station	7	
Other convenient tuner functions	8	
Scanning broadcast stations	8	
Selecting FM reception sound	8	
TAPE OPERATIONS	9	
Listening to a tape	9	
SOUND ADJUSTMENTS	10	
Turning on/off the loudness function	10	
Selecting preset sound modes	10	
Adjusting the sound	11	
Storing your own sound adjustments	12	
OTHER MAIN FUNCTIONS	13	
Setting the clock	13	
Detaching the control panel	14	
CD CHANGER OPERATIONS	15	
Playing CDs	15	
Selecting CD playback modes	17	
MAINTENANCE	18	
To extend the lifetime of the unit	18	
How to reset your unit	18	
TROUBLESHOOTING	19	
SPECIFICATIONS	20	

BEFORE USE

* For safety....

- Do not raise the volume level too much, as this will block outside sounds, making driving dangerous.
- Stop the car before performing any complicated operations.

* Temperature inside the car....

If you have parked the car for a long time in hot or cold weather, wait until the temperature in the car becomes normal before operating the unit.

BASIC OPERATIONS

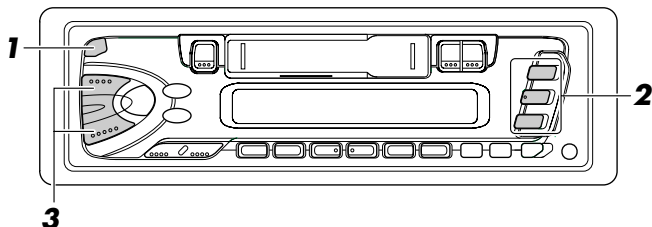

Note:

When you use this unit for the first time, set the built-in clock correctly, see page 13.

1



Turn on the power.

Notes on One-Touch Operation:

- When you select tuner as a source in step 2 below, the power automatically comes on. You do not have to press this button to turn on the power.
- If the cassette is already in the cassette compartment, tape play starts automatically. However, it is not recommended to leave the cassette in the compartment when turning off the power or ignition key. It may damage the tape head and the cassette.

2

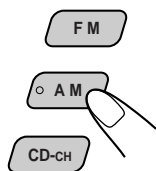

Play the source.

To operate the tuner, see pages 4 – 8.

To operate the tape deck, see page 9.

To operate the CD changer, see pages 15 – 17.

3

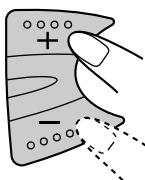

Adjust the volume.



Volume level appears

4

Adjust the sound as you want (see pages 10 – 12).

To drop the volume in a moment

Press \odot /I/ATT briefly while listening to any source. “ATT” starts flashing on the display, and the volume level will drop in a moment.

To resume the previous volume level, press the button briefly again.

To turn off the power

Press \odot /I/ATT for more than 1 second.



RADIO OPERATIONS

ENGLISH

Listening to the radio

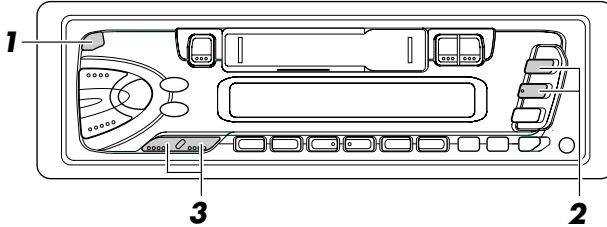

1

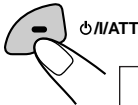

Turn on the power.

Note on One-Touch Operation:

When you select a band in step 2 below, the power automatically comes on. You do not have to press this button to turn on the power.

2

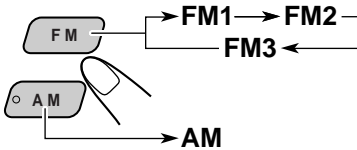

Select the band (FM1, FM2, FM3 or AM).

You can select any one of FM1, FM2, and FM3 to listen to an FM station.



Note:

When a cassette is in the cassette compartment, you cannot select the tuner. Be sure to eject the cassette from the cassette compartment to listen to the radio.

3

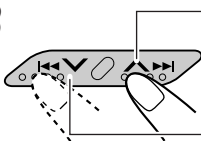

To search stations of higher frequencies.

To search stations of lower frequencies.

Start searching a station.

When a station is received, searching stops.



To stop searching before a station is received, press the same button you have pressed for searching.

To tune in a particular frequency manually:

1 Press FM or AM to select the band.

2 Press and hold \blacktriangle \blacktriangleright or \blacktriangleleft \blacktriangledown until "M" starts flashing on the display.

Now you can manually change the frequency while "M" is flashing.

3 Press \blacktriangle \blacktriangleright or \blacktriangleleft \blacktriangledown repeatedly until the frequency you want is reached.

• If you hold down the button, the frequency keeps changing until you release the button.

Storing stations in memory

You can use one of the following two methods to store broadcasting stations in memory.

- Automatic preset of FM stations: SSM (Strong-station Sequential Memory)
- Manual preset of both FM and AM stations.

FM station automatic preset: SSM

You can preset 6 local FM stations in each FM band (FM1, FM2 and FM3).

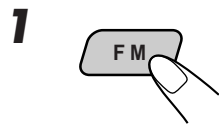
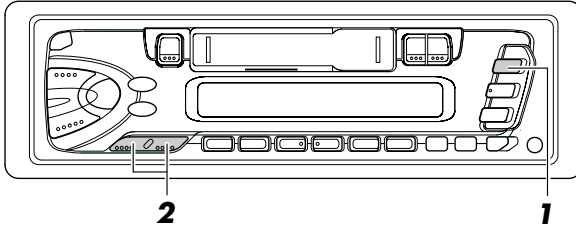

Select the FM band number (FM1, FM2 or FM3) you want to store FM stations into.

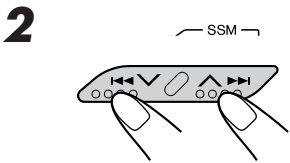

Press and hold the button for more than 2 seconds.

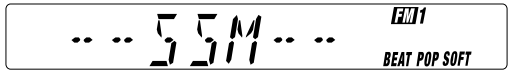

"SSM" appears, then disappears when automatic preset is over.

Local FM stations with the strongest signals are searched and stored automatically in the band number you have selected (FM1, FM2 or FM3). These stations are preset in the number buttons — No. 1 (lowest frequency) to No. 6 (highest frequency).

When automatic preset is over, the station stored in number button 1 will be automatically tuned in.



Manual preset

You can preset up to 6 stations in each band (FM1, FM2, FM3 and AM) manually.

Example: Storing an FM station of 88.3 MHz into the preset number 1 of the FM1 band.

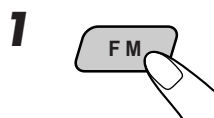
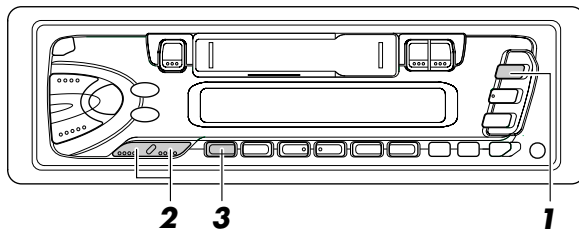

Select the FM1 band.

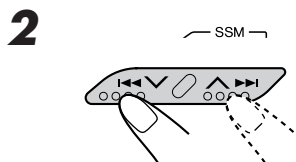
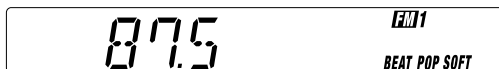

Tune into a station of 88.3 MHz.
See page 4 to tune into a station.

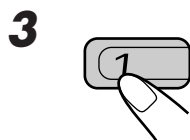

Press and hold the button for more than 2 seconds.



Preset number "P1" flashes for a while.

4 Repeat the above procedure to store other stations into other preset numbers.

Notes:

- A previously preset station is erased when a new station is stored in the same preset number.
- Preset stations are erased when the power supply to the memory circuit is interrupted (for example, during battery replacement). If this occurs, preset the stations again.

Tuning into a preset station

You can easily tune into a preset station.
Remember that you must store stations first. If you have not stored them yet, see page 5 or 6.

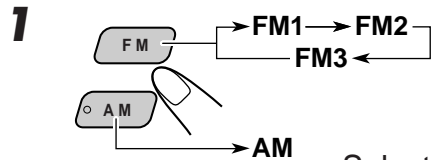
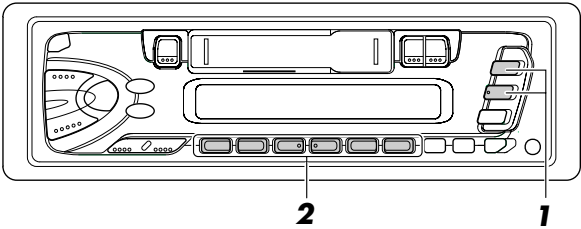

Select the band (FM1, FM2, FM3 or AM) you want.

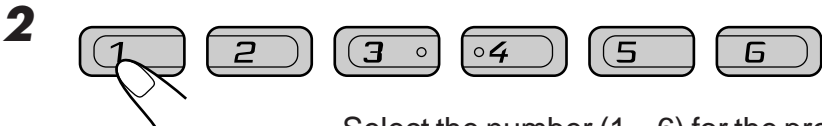

Select the number (1 – 6) for the preset station you want.



Other convenient tuner functions

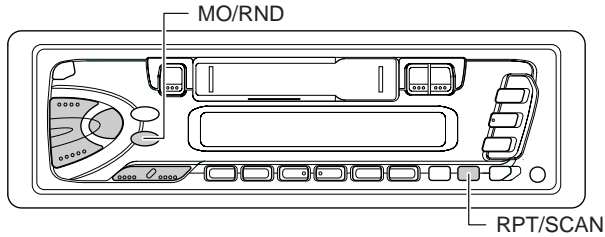

Scanning broadcast stations

When you press RPT/SCAN while listening to the radio, station scanning starts. Each time a broadcast is tuned in, scanning stops for about 5 seconds (tuned frequency number flashes on the display), and you can check what program is now being broadcast.

If you want to listen to that program, press the same button again to stop scanning.

Selecting FM reception sound

When an FM stereo broadcast is hard to receive:

Press MO/RND while listening to an FM stereo broadcast. The sound you hear becomes monaural but reception will be improved.

Lights when receiving an FM broadcast in stereo



To restore the stereo effect, press the same button again.

TAPE OPERATIONS



Listening to a tape

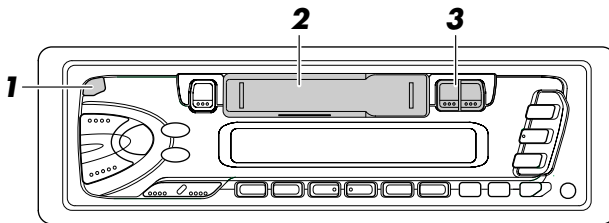

1



Turn on the power.

2

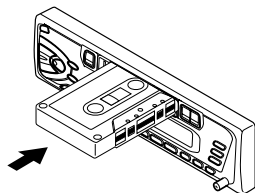

Insert a cassette.

When one side of the tape reaches its end during play, the other side of the tape automatically starts playing. (Auto Reverse)

3

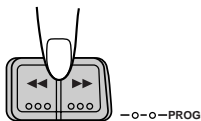

Select the tape direction.

- Press the both buttons at the same time.

Each time you press the button, the tape direction changes alternatively – forward (TAPE >>>) and reverse (TAPE <<<).

To stop play and eject the cassette

Press ▲.

Tape play stops and the cassette ejects from the cassette compartment.

You can hear the last received station.

- You can also eject the cassette with the unit turned off.

To fast-wind a tape

Press either ►► or ◀◀.

The tape will be wound in the direction of the arrows (►► or ◀◀).

To restart playback, press ►► or ◀◀ lightly.

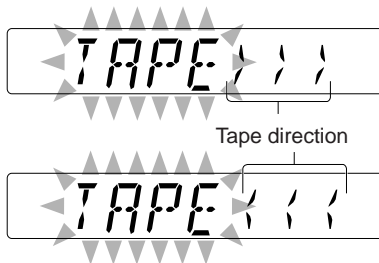



SOUND ADJUSTMENTS

Turning on/off the loudness function

The human ear is less sensitive to low and high frequencies at low volumes. The loudness function can boost these frequencies to produce a well-balanced sound at low volume levels.

Each time you press LOUD, the loudness function turns on/off alternatively.



LOUD ON

LOUD OFF

Selecting preset sound modes

You can select a preset sound adjustment suitable to the music genre.

Each time you press SOUND, the sound mode changes as follows.

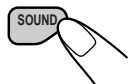

SCM OFF → BEAT → POP → SOFT

Indication	For:	Preset values		
		Bass	Treble	Loudness
SCM OFF	(Flat sound)	00	00	On
BEAT	Rock or disco music	+2	00	On
POP	Light music	+4	+1	Off
SOFT	Quiet background music	+1	-3	Off

Notes:

- You can adjust the preset sound mode to your preference, and store it in memory. If you want to adjust and store your original sound mode, see "Storing your own sound adjustments" on page 12.
- To adjust only the bass and treble reinforcement levels to your preference, see "Adjusting the sound" on page 11.
- When one of the sound modes is selected, it is shown on the display as follows:

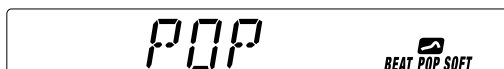

For example, when "POP" is selected.



Adjusting the sound

You can adjust the treble/bass sound and the speaker balance.

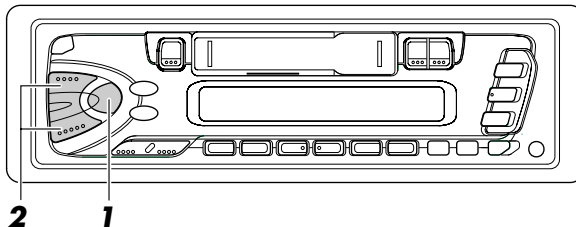

1

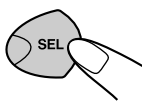

Select the item you want to adjust.

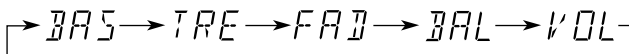

Indication	To do:	Range
BAS (bass)	Adjust the bass	-6 (min.) — +6 (max.)
TRE (treble)	Adjust the treble	-6 (min.) — +6 (max.)
FAD (Fader)*	Adjust the front and rear speaker balance	R6 (rear only) — F6 (front only)
BAL (Balance)	Adjust the left and right speaker balance	L6 (left only) — R6 (right only)
VOL (Volume)	Adjust the volume	00 (min.) — 50 (max.)

Note:

* If you are using a two-speaker system, set the fader level to "00".

2

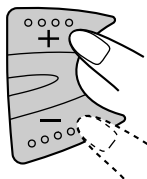

Adjust the level.

Note:

Normally the + and - buttons work as the volume control buttons. So you do not have to select "VOL" to adjust the volume level.



Storing your own sound adjustments

You can adjust the sound modes (BEAT, POP, SOFT: see page 10) to your preference and store your own adjustments in memory.

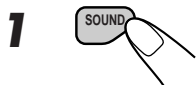
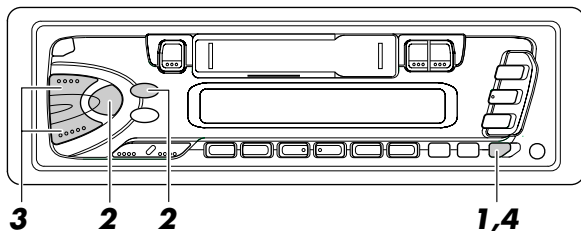

Call up the sound mode you want to adjust.
See page 10 for details.

**Within
5 seconds**

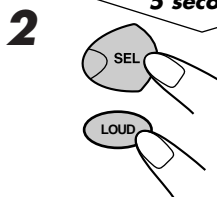

To adjust the bass or treble sound level
Select "BAS" or "TRE."

To turn on or off the loudness function
Each time you press LOUD, the loudness function turns on
and off alternatively. (→ go to step 4)

**Within
5 seconds**

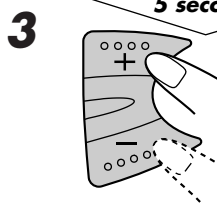

Adjust the bass or treble level.
See page 11 for details.

**Within
5 seconds**

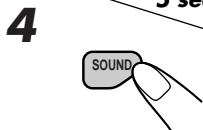

Press and hold SOUND until the sound mode
you have selected in step 1 flashes on the
display.
Your setting is stored in memory.

5 Repeat the same procedure to store other settings.

To reset to the factory settings

Repeat the same procedure and reassign the preset values listed in the table on page 10.

Setting the clock

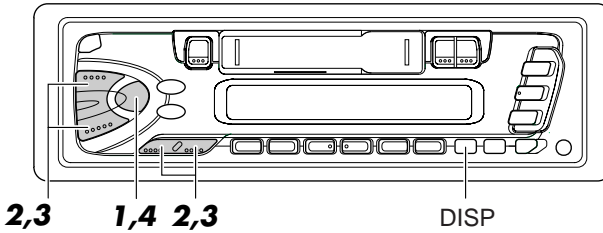

1 Press and hold the button for more than 2 seconds.
"CLOCK H" or "CLOCK M" appears on the display.

2 **1.** Set the hour.
1. Select "CLOCK H" if not shown on the display.
 2. Adjust the hour.

3 **1.** Set the minute.
1. Select "CLOCK M".
 2. Adjust the minute.

4 Start the clock.

To check the current clock time (changing the display mode)

Press DISP repeatedly. Each time you press the button, the display mode changes as follows.

<p>During tuner operation:</p> <p>Frequency ↔ Clock</p>	<p>During tape operation:</p> <p>Play mode ↔ Clock</p>	<p>During CD changer operation:</p> <p>Elapsed playing time → Disc number</p> <p>↑ Clock ←</p>
---	--	--

Detaching the control panel

You can detach the control panel when leaving the car. When detaching or attaching the control panel, be careful not to damage the connectors on the back of the control panel and on the panel holder.

How to detach the control panel

Before detaching the control panel, be sure to turn off the power.

- 1 Unlock the control panel.

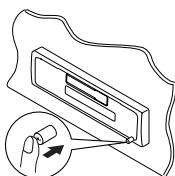

- 2 Lift and pull the control panel out of the unit.

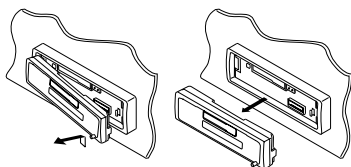

- 3 Put the detached control panel into the provided case.

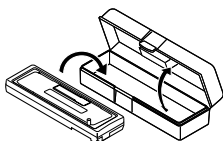

How to attach the control panel

- 1 Insert the left side of the control panel into the groove on the panel holder.

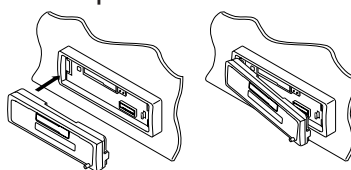

- 2 Press the right side of the control panel to fix it to the panel holder.

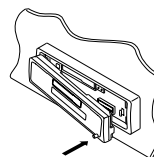

Note on cleaning the connectors:

If you frequently detach the control panel, the connectors will deteriorate.

To minimize this possibility, periodically wipe the connectors with a cotton swab or cloth moistened with alcohol, being careful not to damage the connectors.

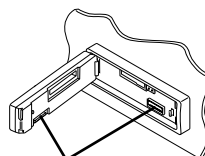

Connectors

CD CHANGER OPERATIONS

We recommend that you use one of the CH-X series with your unit.

If you have another CD automatic changer, consult your JVC car audio dealer for connections.

- For example, if your CD automatic changer is one of the KD-MK series, you need a cord (KS-U15K) for connecting it to this unit.

Before operating your CD automatic changer:

- Refer also to the Instructions supplied with your CD changer.
- If no discs are in the magazine of the CD changer or the discs are inserted upside down, "NO CD" or "NO DISC" will appear on the display. If this happens, remove the magazine and set the discs correctly.
- If "RESET 1 - RESET 8" appears on the display, something is wrong with the connection between this unit and the CD changer. If this happens, check the connection, connect the connecting cord(s) firmly if necessary, then press the reset button of the CD changer.

Playing CDs

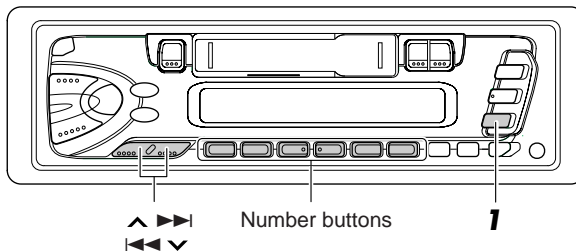

1

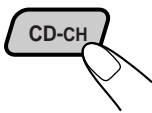

Select the CD automatic changer.

Playback starts from the first track of the first disc.
All tracks of all discs are played back.

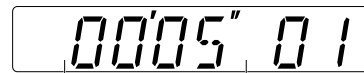
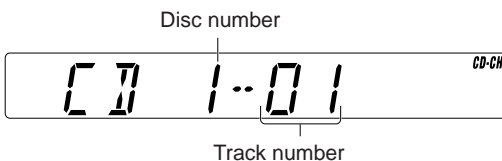

Elapsed playing time
(The clock time is shown if you have pressed DISP to see the clock time. See page 13.)

Note on One-Touch Operation:

When you press CD-CH, the power automatically comes on. You do not have to press /ATT to turn on the power.



To fast forward or reverse the track



To go to the next track or the previous track

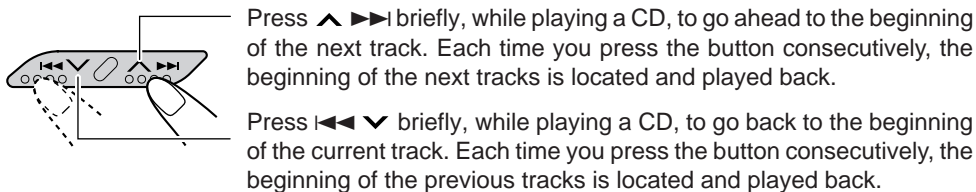

To go to a particular disc directly

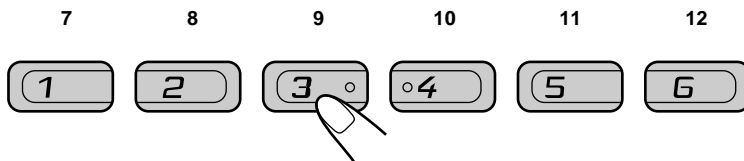

Press the number button corresponding to the disc number to start its playback.

- To select a disc number from 1 – 6:
Press 1 (7) – 6 (12) briefly.
- To select a disc number from 7 – 12:
Press and hold 1 (7) – 6 (12) for more than 1 second.

Ex. When disc number 3 is selected

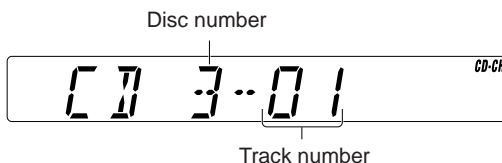



Selecting CD playback modes

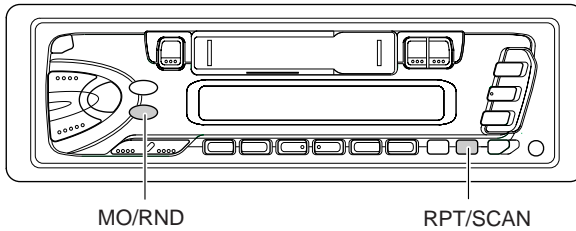

To play back tracks at random (Random Play)

Each time you press MO/RND (Mono/Random) while playing a CD, CD random play mode changes as follows:



Mode	RND Indicator	Plays at random
RND1	Lights	All tracks of the current disc, then the tracks of the next disc, and so on.
RND2	Flashes	All tracks of all discs inserted in the magazine.

To play back tracks repeatedly (Repeat Play)

Each time you press RPT/SCAN (Repeat/Scan) while playing a CD, CD repeat play mode changes as follows:



Mode	RPT Indicator	Plays repeatedly
RPT1	Lights	The current track (or specified track).
RPT2	Flashes	All tracks of the current disc (or specified disc).



MAINTENANCE

ENGLISH

To extend the lifetime of the unit

This unit requires very little attention, but you will be able to extend the life of the unit if you follow the instructions below.

To clean the heads

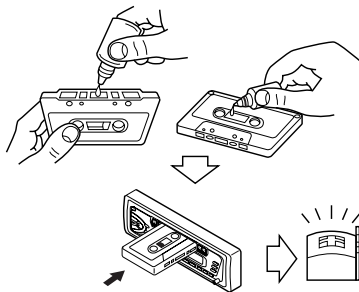

- Clean the heads after every 10 hours of use using a wet-type head cleaning tape (available at an audio store).

When the head becomes dirty, you may realize the following symptoms:

- Sound quality is reduced.
- Sound level decreases.
- Sound drops out.
- Do not play dirty or dusty tapes.
- Do not touch the highly-polished head with any metallic or magnetic tools.

To keep the tape clean

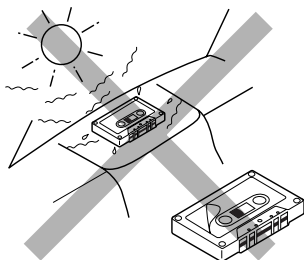

- Always store the tapes to their storage cases after use.
- Do not store tapes in the following places:
 - Subject to direct sunlight
 - With high humidity
 - At extremely hot temperatures

CAUTIONS:

- Do not play the tapes with peeling labels; otherwise, they can damage the unit.
- Tighten tapes to remove slack since loose tape may become entangled with the mechanism.
- Do not leave a cassette in the cassette compartment after use, as the tape may become slack.

How to reset your unit

Press and hold both the SEL (Select) and O/I/ATT (Standby/On/ATT) buttons at the same time for several seconds.

This will reset the built-in microcomputer.

NOTE: Your preset adjustments — such as preset channels or sound adjustments — will also be erased.

O/I/ATT
(Standby/On/ATT)

SEL (Select)

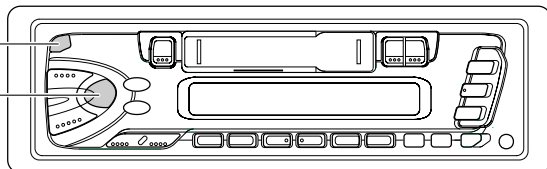

TROUBLESHOOTING

What appears to be trouble is not always serious. Check the following points before calling a service center.

Symptoms	Causes	Remedies
<ul style="list-style-type: none"> A cassette tape cannot be inserted. 	You have tried to insert a cassette in the wrong way.	Insert the cassette with the exposed tape facing right.
<ul style="list-style-type: none"> Cassette tapes become hot. 	This is not a malfunction.	_____
<ul style="list-style-type: none"> Tape sound is at very low level and sound quality is degraded. 	The tape head is dirty.	Clean it with a head cleaning tape.
<ul style="list-style-type: none"> Sound is sometimes interrupted. 	Connections are not good.	Check the cords and connections.
<ul style="list-style-type: none"> Sound cannot be heard from the speakers. 	The volume control is turned to the minimum level.	Adjust it to the optimum level.
	Connections are incorrect.	Check the cords and connections.
<ul style="list-style-type: none"> Static noise while listening to the radio. 	The antenna is not connected firmly.	Connect the antenna firmly.
<ul style="list-style-type: none"> “NO CD” or “NO DISC” appears on the display. 	No CD is in the magazine.	Insert CDs into the magazine.
	CDs are inserted incorrectly.	Insert them correctly.
<ul style="list-style-type: none"> “RESET 8” appears on the display. 	This unit is not connected to a CD changer correctly.	Connect this unit and the CD changer correctly and press the reset button of the CD changer.
<ul style="list-style-type: none"> “RESET 1-RESET 7” appears on the display. 	_____	Press the reset button of the CD changer.
<ul style="list-style-type: none"> The unit does not work at all. The CD changer does not work at all. 	The built-in microcomputer may function incorrectly due to noise, etc.	While holding SEL, press ⏻/ATT for more than 2 seconds to reset the unit. (The clock setting and preset stations stored in memory are erased.) (See page 18).



SPECIFICATIONS

ENGLISH

AUDIO AMPLIFIER SECTION

Maximum Power Output:

Front: 40 watts per channel

Rear: 40 watts per channel

Continuous Power Output (RMS):

Front: 16 watts per channel into 4 Ω , 40 Hz to 20 000 Hz at no more than 0.8% total harmonic distortion.

Rear: 16 watts per channel into 4 Ω , 40 Hz to 20 000 Hz at no more than 0.8% total harmonic distortion.

Load Impedance: 4 Ω (4 Ω to 8 Ω allowance)

Tone Control Range

Bass: ± 10 dB at 100 Hz

Treble: ± 10 dB at 10 kHz

Frequency Response: 40 Hz to 20 000 Hz

Signal-to-Noise Ratio: 70 dB

Line-Out Level/Impedance: 2.0 V/20 k Ω load
(250 nWb/m)

Output Impedance: 1 k Ω

TUNER SECTION

Frequency Range

FM: 87.5 MHz to 108.0 MHz

AM: 531 kHz to 1 602 kHz

[FM Tuner]

Usable Sensitivity: 11.3 dBf (1.0 μ V/75 Ω)

50 dB Quieting Sensitivity:

16.3 dBf (1.8 μ V/75 Ω)

Alternate Channel Selectivity (400 kHz):

65 dB

Frequency Response: 40 Hz to 15 000 Hz

Stereo Separation: 35 dB

Capture Ratio: 2.0 dB

[AM Tuner]

Sensitivity: 20 μ V

Selectivity: 35 dB

CASSETTE DECK SECTION

Wow & Flutter: 0.15% (WRMS)

Fast-Wind Time: 190 sec. (C-60)

Frequency Response:

50 Hz to 14 000 Hz (± 3 dB)

Signal-to-Noise Ratio: 52 dB

Stereo Separation: 40 dB

GENERAL

Power Requirement

Operating Voltage: DC 14.4 volts (11 volts to 16 volts allowance)

Grounding System: Negative ground

Allowable Working Temperature:

0°C to +40°C (32°F to 104°F)

Dimensions (W x H x D)

Installation Size: 182 mm x 52 mm x 150 mm

Panel Size: 188 mm x 58 mm x 14 mm

Mass: 1.3 kg (2.9 lbs) (excluding accessories)

Design and specifications subject to change without notice.

Having TROUBLE with operation?

Please reset your unit

Refer to page of How to Reset

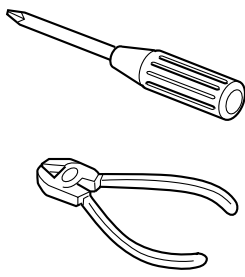

ENGLISH

- This unit is designed to operate only on 12 volts DC, NEGATIVE ground electrical systems.

INSTALLATION (IN-DASH MOUNTING)

- The following illustration shows a typical installation. However, you should make adjustments corresponding to your specific car. If you have any questions or require information regarding installation kits, consult your JVC car audio dealer or a company supplying kits.

中文

- 本機僅可使用直流 12V、負極接地的電源系統。

安裝 (裝設、 固定在儀表板內)

- 下面的圖解表示了典型的安裝程序。然而，您應當做些適當的調整，以便適應您自己的汽車。如果您有問題，或需要有關配套元件的資料，請向JVC汽車音響分銷商或配套元件供應公司詢問。

عربي

- لقد صمم هذا الجهاز ليعمل فقط بواسطة تيار كهربائي مباشر DC، ١٢ فولت، انظمة كهربائية تأريض سالب.

تركيب الجهاز (داخل-تابلو السيارة)

- يبيّن الرسم التوضيحي التالي طريقة التركيب المثالية. مع ذلك، يجب عليك عمل تعديلات تطابق نوع السيارة التي تمتلكها. إذا كان هناك استفسارات او حاجة لمعلومات بخصوص ادوات التركيب، يرجى استشارة موزع الاجهزة الصوتية للسيارات ماركة JVC او الشركة الموزعة لهذه الادوات.

- 1 Before mounting:** Press (Control Panel Release button) to detach the control panel.
- Remove the trim plate.
- Remove the sleeve after disengaging the sleeve locks.
 - Stand the unit.

Note: When you stand the unit, be careful not to damage the fuse on the rear.
 - Insert the 2 handles between the unit and the sleeve, as illustrated, to disengage the sleeve locks.
 - Remove the sleeve.

Note: Be sure to keep the handles for future use after installing the unit.
- Install the sleeve into the dashboard.

* After the sleeve is correctly installed in the dashboard, bend the appropriate tabs to hold the sleeve firmly in place, as illustrated.
- Fix the mounting bolt to the rear of the unit's body and place the rubber cushion over the end of the bolt.
- Do the required electrical connections explained on the back of this instructions.
- Slide the unit into the sleeve until it is locked.
- Attach the trim plate.
- Attach the control panel.

- 1 裝設之前:** 按下控制面板解脫按鈕 拆脫控制面板。
- 取下裝飾框。
- 解開扣板，取下本機的外套機殼。
 - 將本機豎起。

注意: 您豎起本機時，小心不要損壞底部的保險絲。
 - 按圖所示，在本機和外套機殼之間插入兩片板條型的把手，解開外套機殼扣板。
 - 取下外套機殼。

注意: 安裝本機後，務必保存好兩片把手，以備將來使用。
- 將外套機殼裝入儀表板內。

*在外套機殼準確地裝入儀表板之後，按圖所示，彎曲機殼的突舌，把外套機殼牢固在儀表板內。
- 將緊固螺栓旋緊在本機機體上，並將橡膠防震墊套在緊固螺栓的尾部。
- 按本說明書後面所述，進行所需要的電路連接。
- 將本機滑入外套機殼，直到扣板鎖住為止。
- 裝上裝飾框。
- 裝上控制面板。

- ١ قبل بدء التركيب:** اضغط الرز (زر تحرير لوحة التحكم) من اجل فصل لوحة التحكم.
- انزع لوحة الزينة.
- انزع الهيكل الواقي بعد فصل مثبتات الهيكل الواقي.
 - اوقف الجهاز بشكل عمودي.

ملاحظة: عند توقيف الجهاز، تأكد من عدم تضرر او اتلاف الفيوز الموجود في الجهة الخلفية من الجهاز.
 - ادخل المساكين بين الجهاز والهيكل الواقي، كما هو مبين في الشكل، لفصل مثبتات الهيكل الواقي.
 - انزع الهيكل الواقي.
- ملاحظة:** يرجى المحافظة على المساكات من اجل الاستعمال لاحقاً بعد تركيب الجهاز.

ركب الهيكل الواقي داخل تابلو السيارة.
- بعد تركيب الهيكل الواقي كلياً داخل تابلو السيارة بشكل صحيح، اثني الألسنة بشكل مناسب لتثبيت الهيكل الواقي بشكل محكم في المكان الصحيح، كما هو مبين في الشكل.
- ثبت مسمار التركيب بالجهة الخلفية من هيكل الجهاز وبعد ذلك ضع الحشوة المطاطية فوق نهاية المسمار.
- اعمل التوصيلات الكهربائية المطلوبة كما هو مشروح خلف هذه التعليمات.
- ادخل الجهاز داخل الهيكل الواقي حتى يثبت بشكل صحيح.
- ركب لوحة الزينة.
- ركب لوحة التحكم.

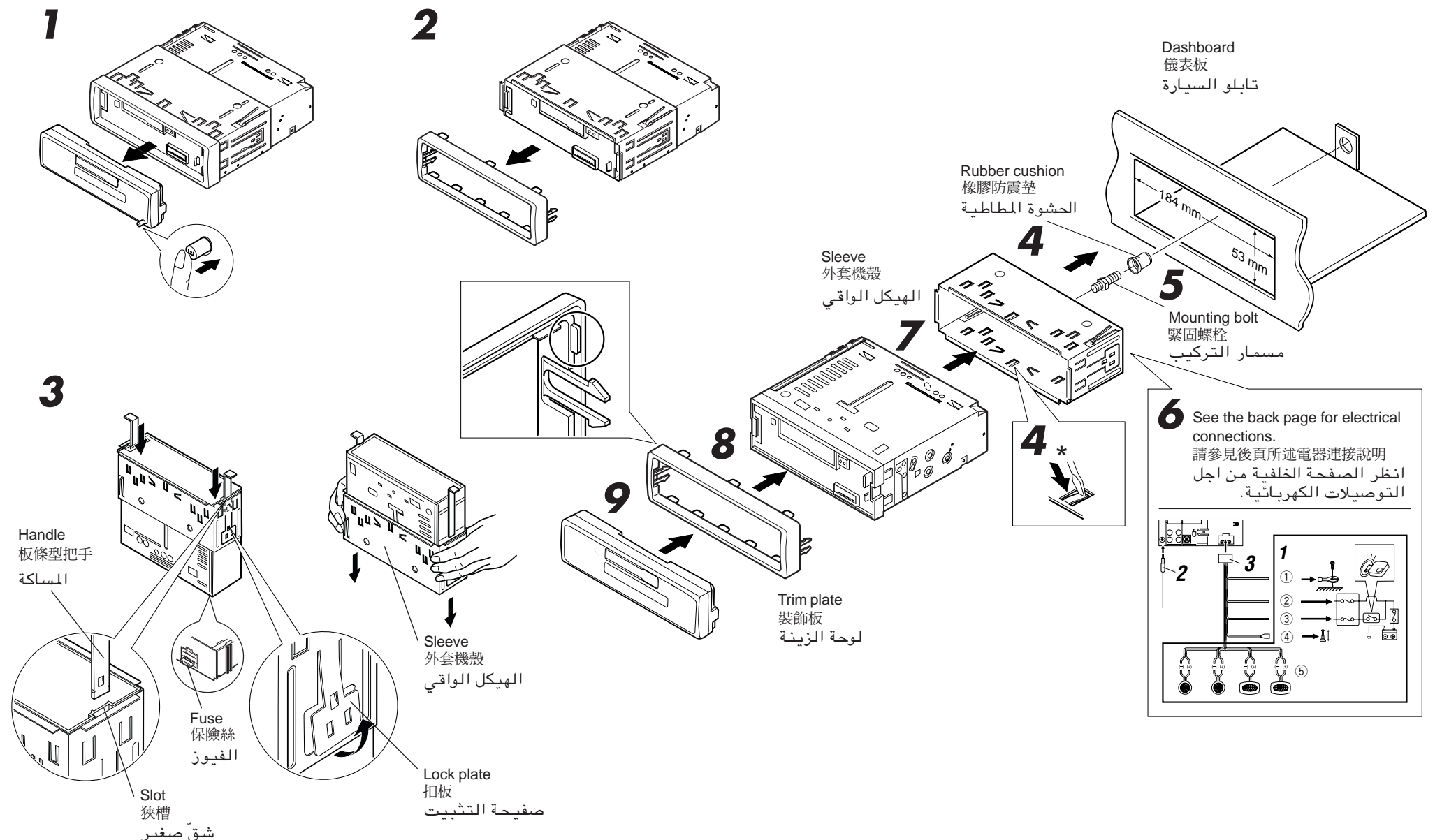

• When using the optional stay

• 若選用支撐架

• عند استخدام مسند اضافي للتثبيت

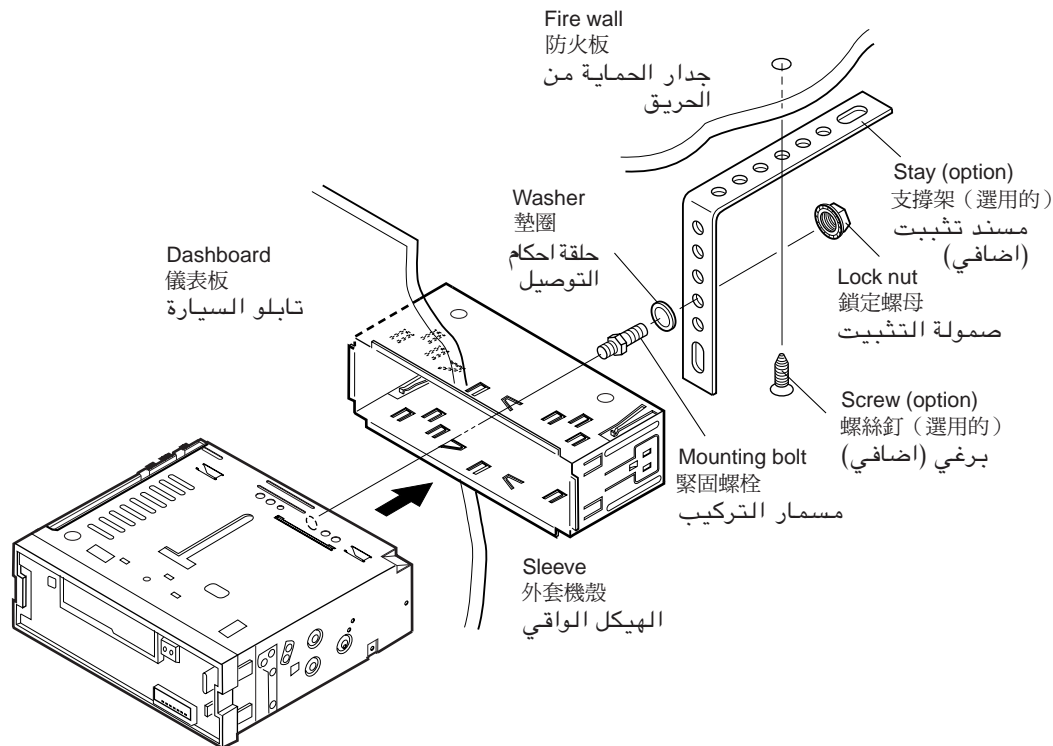

• When installing the unit without using the sleeve

• 若不使用外套機殼安裝本機

• عندما تركيب الجهاز بدون استخدام الهيكل الواقي

In a Toyota for example, first remove the car radio and install the unit in its place. 以豐田牌 (TOYOTA) 汽車為例：首先取出汽車收音機，然後將本機裝入其空出的位置。 على سبيل المثال، في سيارات نوع تويوتا، انزع راديو السيارة اولا بعد ذلك ركّب الجهاز في مكانه.

Flat type screws (M5 x 6 mm)*

平頭螺絲釘 (M5 x 6 mm)*

*براغي مستوية القاعدة (6 x M5 ملم)

* Not included with this unit.

* 不包括在本機中

* غير مزود مع هذا الجهاز.

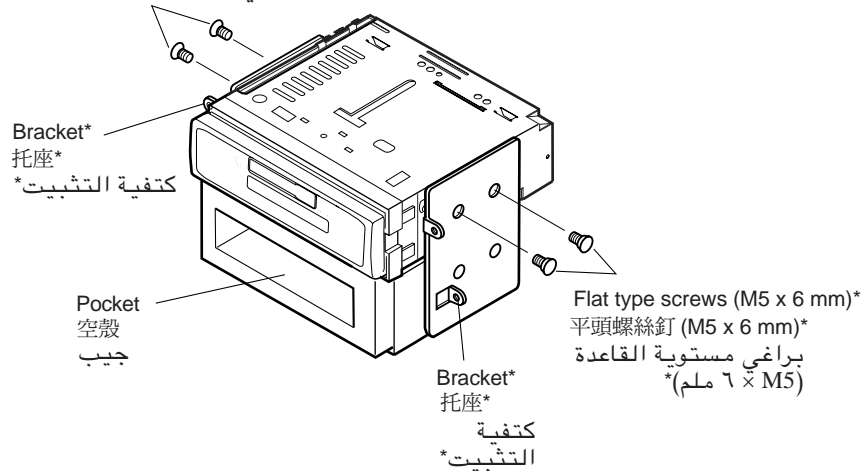

Note: When installing the unit on the mounting bracket, make sure to use the 6 mm-long screws. If longer screws are used, they could damage the unit.

注意：把本機安裝在托座上時，務必使用6mm長的螺絲釘。如使用過長的螺絲釘，會損壞本機。

ملاحظة: عند تركيب الجهاز على كتفية التثبيت، تأكد من استخدام براغي طول 6 ملم. في حالة استخدام براغي اطول من 6 ملم، فان ذلك يمكن ان يسبب تلف او ضرر للجهاز.

Removing the unit

• Before removing the unit, release the rear section.

1 Remove the control panel.

2 Remove the trim plate.

3 Insert the 2 handles into the slots, as shown. Then, while gently pulling the handles away from each other, slide out the unit. (Be sure to keep the handles after installing it.)

拆卸本機

• 在拆卸本機前，應將本機後部的固定和連接部分鬆開。

1 拆下控制面板。

2 取下裝飾框。

3 按圖所示，將兩片板條型把手插入卡槽，然後輕穩地從兩側向外拉兩片把手，本機隨之拉出。(安裝本機後，務必保存好兩片把手)

نزع الجهاز من تابلو السيارة

• قبل نزع الجهاز، حرر الجزء الخلفي.

1 انزع لوحة التحكم.

2 انزع لوحة الزينة.

3 ادخل المساكين داخل الشقوق، كما هو مبين في الشكل. بعد ذلك، اثناء سحب المساكين بلطافة بعيدا الواحدة عن الأخرى، اسحب الجهاز الى الخارج.

(تأكد من احتفاظك بالمساكين بعد تركيب الجهاز)

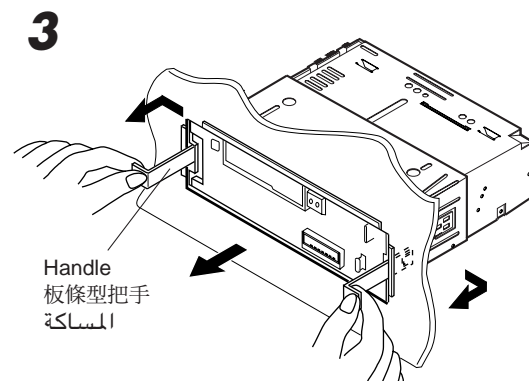
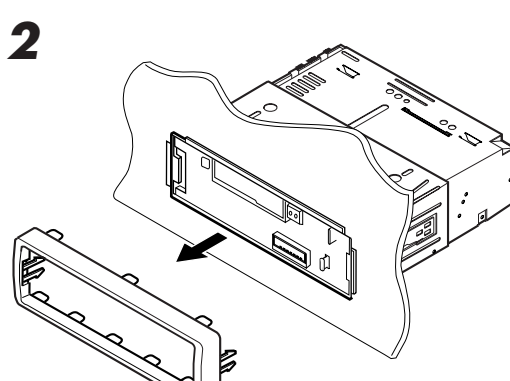
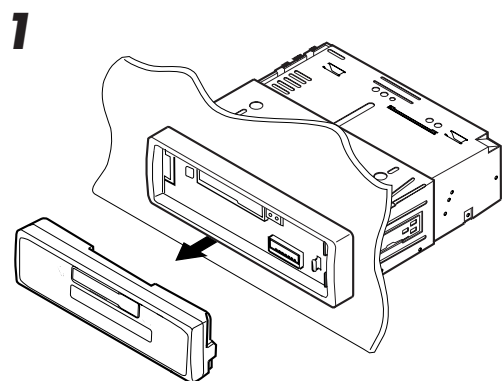

Parts list for installation and connection

The following parts are provided with this unit. After checking them, please set them correctly.

用於安裝和連接的零件裏

下列零件是隨本機提供的。清點以後，正確的將其裝配。

قائمة اجزاء التركيب والتوصيل

الاجزاء التالية مزودة مع الجهاز. بعد فحص هذه الاجزاء، يرجى تركيبهم بشكل صحيح.

Hard case
硬盒
صندوق صلب

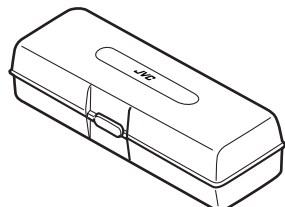

Power cord
電路連接用的配線束
سلك الطاقة الكهربائية

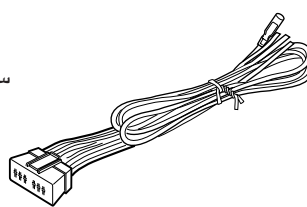

Lock nut (M5)
鎖緊螺母 (M5)
صمولة التثبيت (M5)



Trim plate
裝飾板
لوحة الزينة

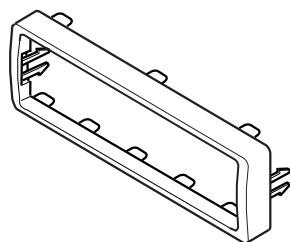

Handles
板條型把手
المسكات



Mounting bolt (M5 x 20 mm)
緊固螺絲 (M5 x 20 mm)
مسمار التركيب (M5 x 20 ملم)



Sleeve
外套機殼
الهيكل الواقي

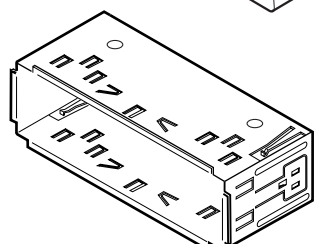

Rubber cushion
橡膠防震墊
الحشوة المطاطية



Washer (ø5)
墊圈 (ø5)
حلقة احكام
التوصيل (قطر 5)



ELECTRICAL CONNECTIONS

電路連接

التوصيلات الكهربائية

To prevent short circuits, we recommend that you disconnect the battery's negative terminal and make all electrical connections before installing the unit. If you are not sure how to install this unit correctly, have it installed by a qualified technician.

Note:

This unit is designed to operate only on **12 volts DC, NEGATIVE ground electrical systems**. If your vehicle does not have this system, a voltage inverter is required, which can be purchased at JVC car audio dealers.

- Replace the fuse with one of the specified rating. If the fuse blows frequently, consult your JVC car audio dealer.
- If noise is a problem...

This unit incorporates a noise filter in the power circuit. However, with some vehicles, clicking or other unwanted noise may occur. If this happens, connect the unit's **rear ground terminal** (See connection diagram below.) to the car's chassis using shorter and thicker cords, such as copper braiding or gauge wire. If noise still persists, consult your JVC car audio dealer.

- Maximum input of the speakers should be more than 40 watts at the rear and 40 watts at the front, with an impedance of **4 to 8 ohms**.

• **Be sure to ground this unit to the car's chassis.**

- The heat sink becomes very hot after use. Be careful not to touch it when removing this unit.

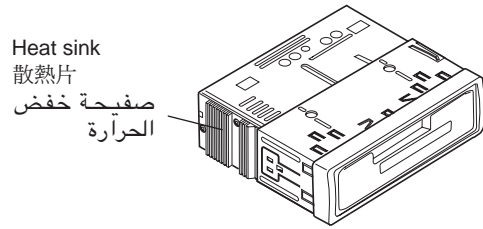

為防止短路，建議在安裝本機之前，斷開電池的負極，並把所有電路都連接好。如果您不能確定如何正確地安裝本機，應請合格的技術人員來安裝。

注意：

本機僅可使用直流**12V**、負極接地的電源系統。如果您的車輛沒有這一電源系統，則需要一個電壓變換器，可以在JVC汽車音響分銷商處買到。

- 把保險絲更換為額定負荷值的保險絲。如果保險絲經常燒壞，請向 JVC 汽車音響分銷商詢問。
- 若出現噪音問題

本機在電源回路帶有一個噪音濾器。但是，在某些車輛上，會出現咯咯聲或其它噪音。如果發生這類情況，將本機後面的接地端子用短而粗的導線，如編織銅線或標準電纜，連接到汽車底盤上（見下面的電路接線圖）。如果噪音仍然持續存在，請向 JVC 汽車音響分銷商詢問。

- 後置揚聲器的最大輸入功率應大於 40 瓦，前置揚聲器的最大功率 40 瓦，其阻抗的為 **4 – 8 歐姆**。

• **務必將本機接到汽車底盤上。**

- 本機使用後，散熱片會很熱。因此，在移出本機時，小心不要觸摸散熱片。

لمنع حدوث تقصير في الدوائر الكهربائية، نوصي بفصل طرف البطارية السالب ثم عمل التوصيلات الكهربائية قبل تركيب الجهاز. في حالة عدم معرفتك بكيفية تركيب الجهاز بشكل صحيح، يرجى ترك عملية تركيب الجهاز لشخص مختص ومؤهّل لتركيب مثل هذه الأجهزة.

ملاحظة:

لقد صمم هذا الجهاز ليعمل بواسطة تيار كهربائي مباشر DC، ١٢ فولت، أنظمة كهربائية تأريض سالب. في حالة عدم وجود مثل هذا النظام في سيارتك، يجب استخدام محول فولتاج، ويمكن شراء هذا المحول من وكلاء الأجهزة الصوتية للسيارات ماركة JVC.

• استبدل الفيوز بأخر يحمل نفس القياسات الموصوفة. إذا تكرر احتراق الفيوز، يرجى استشارة وكلاء الأجهزة الصوتية للسيارات ماركة JVC.

• إذا كان الضجيج هو المشكلة... يستخدم هذا الجهاز فلتر ضجيج داخل دائرة الطاقة الكهربائية. مع ذلك، في بعض السيارات، يمكن أن يحدث نوع من الطقطقة أو الضجيج غير المرغوب. في حالة حدوث مثل ذلك، اوصل طرف التأريض الموجود في خلفية الجهاز (انظر رسم التوصيل في الأسفل) مع هيكل السيارة بواسطة استخدام أسلاك اقصر واسمك، مثل سلك النحاس المجذول أو سلك مقياسي. في حالة عدم توقف الطقطقة أو الضجيج، يرجى استشارة وكلاء الأجهزة الصوتية للسيارات ماركة JVC.

• يجب أن يكون الحد الأقصى لدخل السماعات أكثر من ٤٠ واط للسماعات الخلفية و ٤٠ واط للسماعات الامامية، مع ممانعة بين ٤ الى ٨ اوم.

• تأكد من تأريض الجهاز مع هيكل السيارة. تصبح صفحة خفض الحرارة ساخنة جدا بعد الاستخدام. تأكد من عدم ملامستها عند نزع الجهاز.

A Typical Connections / 典型的接線方法 / التوصيلات النموذجية

Before connecting: Check the wiring in the vehicle carefully. Incorrect connection may cause serious damage to this unit.

1 Connect the colored leads of the power cord to the car battery, speakers and automatic antenna (if any) in the following sequence.

- ① Black: ground
- ② Yellow: to car battery (constant 12V)
- ③ Red: to an accessory terminal
- ④ Blue with white stripe: to automatic antenna (200mA max.)
- ⑤ Others: to speakers

2 Connect the antenna cord.

3 Finally connect the wiring harness to the unit.

接線前：仔細檢查汽車內的線路。不正確的接線會導致本機嚴重損壞。

1 按下述順序將配線束各個不同色標的導線接頭分別接至電池、揚聲器和自動升降天線（如有裝設）：

- ① 黑色：接地
- ② 黃色：接至車裝電池（恆定 12V）
- ③ 紅色：接至保險絲單元內的附屬端子
- ④ 藍色帶有白色條紋：接至自動升降天線（最大 200 毫安）
- ⑤ 其他：接至揚聲器

2 將天線的電線連接起來。

3 最後，把配線束的插頭插在本機上。

قبل البدء بالتوصيل: تأكد من شبكة الاسلاك في السيارة بدقة حتى لا يحدث خطأ في عملية توصيل الجهاز. يمكن ان يسبب التوصيل الخاطئ الى حصول عطل حقيقي للجهاز.

1 اوصل الاسلاك الملونة لسلك تزويد الطاقة الكهربائية مع بطارية السيارة، السماعات والهوائي الاوتوماتيكي (ان وجد) حسب التسلسل التالي.

① السلك الاسود: مع الارض (مع هيكل السيارة)

② السلك الاصفر: مع بطارية السيارة (ثابت ١٢ فولت)

③ السلك الاحمر: مع الطرف الاضافي

④ السلك الازرق المخطط بالابيض: مع الهوائي الاوتوماتيكي (الحد الاقصى ٢٠٠ ميلي امبير)

⑤ الاسلاك الاخرى: مع السماعات

2 اوصل سلك الهوائي.

3 اخيرا، اوصل حامل الاسلاك مع الجهاز.

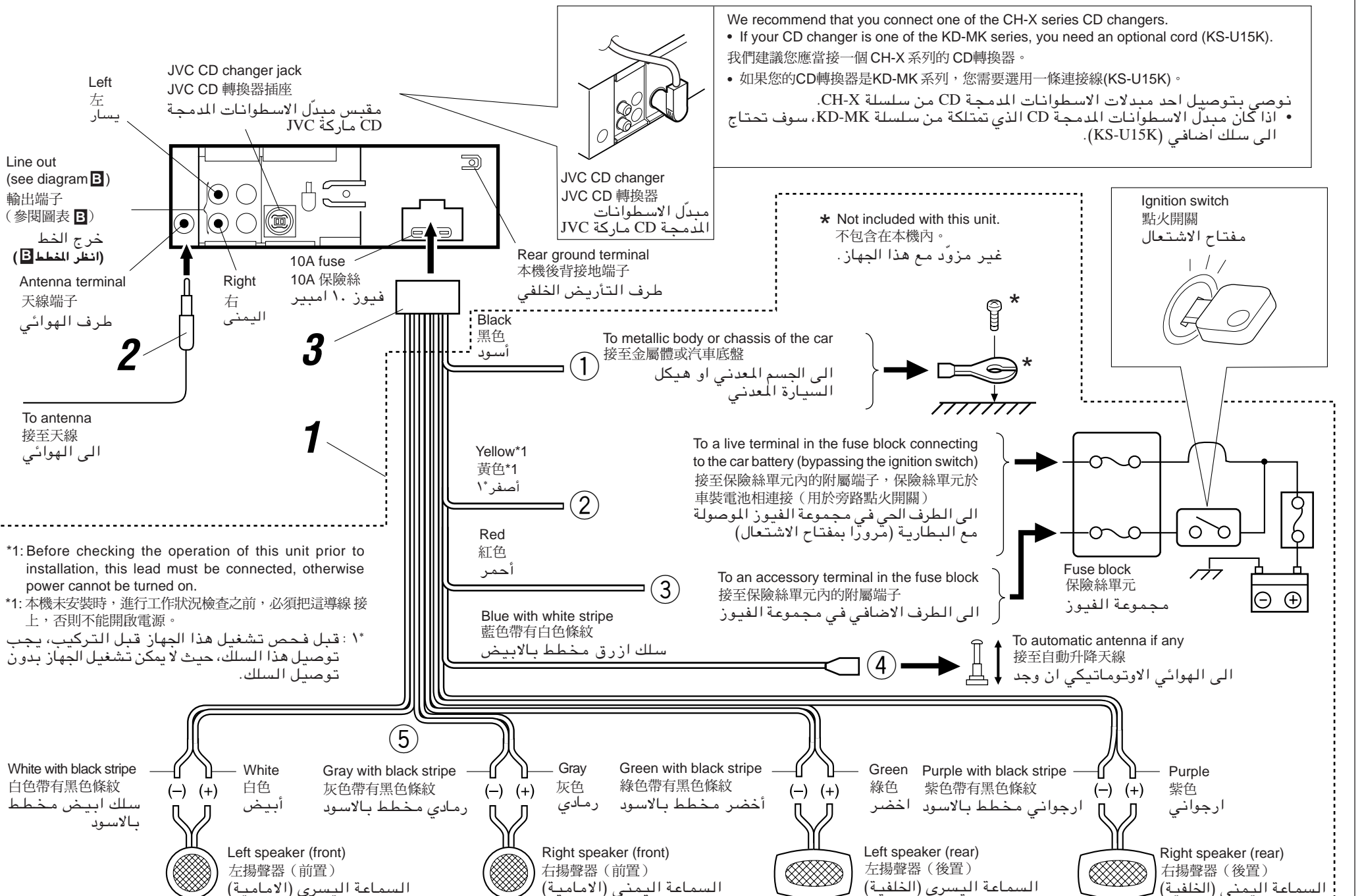

PRECAUTIONS on power supply and speaker connections:

- **DO NOT connect the speaker leads of the power cord to the car battery; otherwise, the unit will be seriously damaged.**
- Connect the black lead (ground), yellow lead (to car battery, constant 12V), and red lead (to an accessory terminal) correctly.
- **BEFORE connecting the speaker leads of the power cord to the speakers, check the speaker wiring in your car.**
 - If the speaker wiring in your car is as illustrated in Fig. 1 and Fig. 2 below, DO NOT connect the unit using that original speaker wiring. If you do, the unit will be seriously damaged. Redo the speaker wiring so that you can connect the unit to the speakers as illustrated in Fig. 3.
 - If the speaker wiring in your car is as illustrated in Fig. 3, you can connect the unit using the original speaker wiring in your car.
 - If you are not sure of the speaker wiring of your car, consult your car dealer.

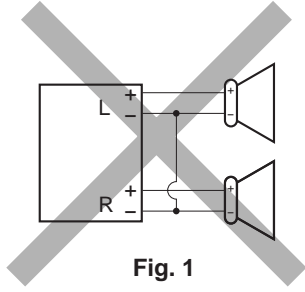

Fig. 1

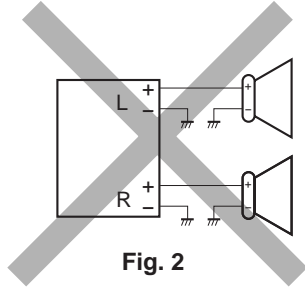

Fig. 2

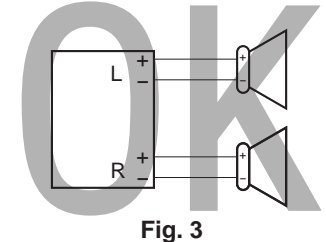

Fig. 3

電源和揚聲器接線注意事項：

- 切勿把揚聲器導線接頭接至電池，否則本機將會嚴重損壞。
- 正確地連接黑色導線接頭（接地）、黃色導線接頭（接車裝電池，恆定 12V）和紅色導線接頭（接至保險絲單元的附屬端子）。
- 在把揚聲器導線接頭接至揚聲器之前，檢查您汽車上的揚聲器線路：
 - 如果您汽車上揚聲器線路象圖1和圖2所示，不要使用原裝的揚聲器線路。如果使用，本機將嚴重損壞。要重新連接揚聲器線路，可按圖3所示，把本機與揚聲器相連接。
 - 如果您汽車上揚聲器線路象圖3所示，可使用原裝的揚聲器線路與本機相連接。
 - 如果您不能確定您汽車上揚聲器線路，請向您的汽車分銷商詢問。

تنبيهات حول تزويد الطاقة الكهربائية وتوصيل السماعات:

- لا توصّل اسلاك تزويد طاقة السماعات مع بطارية السيارة، لأن ذلك يؤدي الى حصول ضرر للسماعات.
- اوصل السلك الاسود (الارضى)، والسلك الاصفر (مع بطارية السيارة، ثابت ١٢ فولت)، والسلك الاحمر (مع الطرف الاضافي) بشكل صحيح.
- قبل توصيل اسلاك تزويد طاقة السماعات مع السماعات، افحص شبكة اسلاك السماعات داخل سيارتك.
- اذا كانت شبكة اسلاك السماعات داخل سيارتك كما هي مبينة في الشكل ١ والشكل ٢ الموجودة في الأسفل، لا توصّل الجهاز بواسطة استخدام شبكة اسلاك السماعات الاصلية. اذا تم توصيل الجهاز بهذه الطريقة، سيؤدي ذلك الى حصول ضرر. اعد عمل شبكة اسلاك السماعات بحيث يمكنك توصيل الجهاز مع السماعات كما هو مبين في الشكل ٣.
- اذا كانت شبكة اسلاك السماعات داخل سيارتك كما هي مبينة في الشكل ٣، يمكنك توصيل الجهاز بواسطة استخدام شبكة اسلاك السماعات الاصلية داخل سيارتك.
- في حالة عدم معرفتك بشبكة اسلاك السماعات داخل سيارتك، استشر الوكيل او ذوي الخبرة بهذا الخصوص.

Connecting the leads / 導線接頭的連接 / توصيل الاسلاك

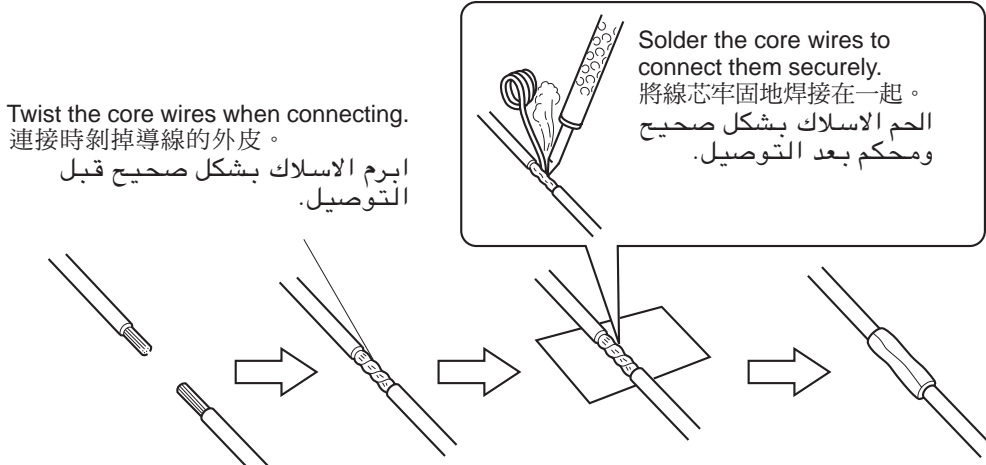

CAUTION / 注意 / تنبيه

- To prevent short-circuit, cover the terminals of the UNUSED leads with insulating tape.
- من اجل منع التقصير في الدوائر - الكهربائية، ضع شريط عازل ولاصق على اطراف الاسلاك غير المستعملة.

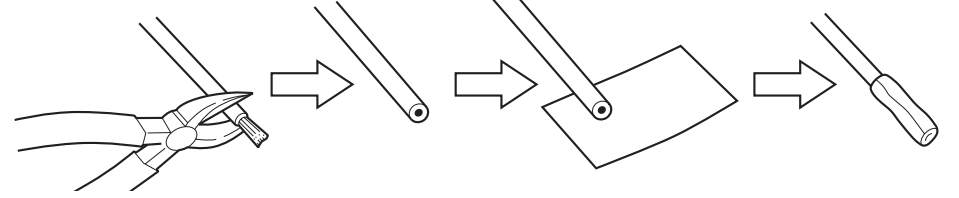

Connections Adding Other Equipment / 連接附加的其他音響設備 / توصيل الاجهزة الاخرى الاضافية

You can connect an amplifier and other equipment to upgrade your car stereo system.

- Connect the remote lead (blue with white stripe) to the remote lead of the other equipment so that it can be controlled through this unit.
- For amplifier only:
 - Connect this unit's line-out terminals to the amplifier's line-in terminals.
 - **Disconnect the speakers from this unit, connect them to the amplifier. Leave the speaker leads of this unit unused. (Cover the terminals of these unused leads with insulating tape, as illustrated above.)**

你可以連接放大器和裝置以加強你的汽車音響系統功能。

- 將遙控線（白條藍線）和其他裝置上的遙控線連接起來，以便可以通過本機進行遙控。
- 僅適用於放大器：
 - 將本機的輸出終端和放大器輸入終端連接起來。
 - 將揚聲器和本機斷開，再接上放大器。將本機的揚聲器接線放置不用。（按照上面所示的方式，用絕緣膠把不用的線端包起來。）

يمكنك توصيل مضخم صوت وجهاز اخر لتحسين اداء جهاز ستيريو السيارة.

- * اوصل سلك التحكم عن بعد (الازرق المخطط بالابيض) مع سلك التحكم عن بعد للجهاز الاخر بحيث يتم التحكم بالجهاز من خلال هذا الجهاز.
- * فقط لمضخم الصوت:
 - اوصل اطراف خرج - الخط لهذا الجهاز مع اطراف دخل - الخط لمضخم الصوت.
 - افصل السماعات من هذا الجهاز، اوصلهم مع مضخم الصوت. اترك اسلاك سماعات هذا الجهاز بدون استعمال. (غطي اطراف هذه الاسلاك غير المستعملة بشريط عازل، كما هو موضح في الاعلى.)

Amplifier / 功率放大器 / مضخم الصوت

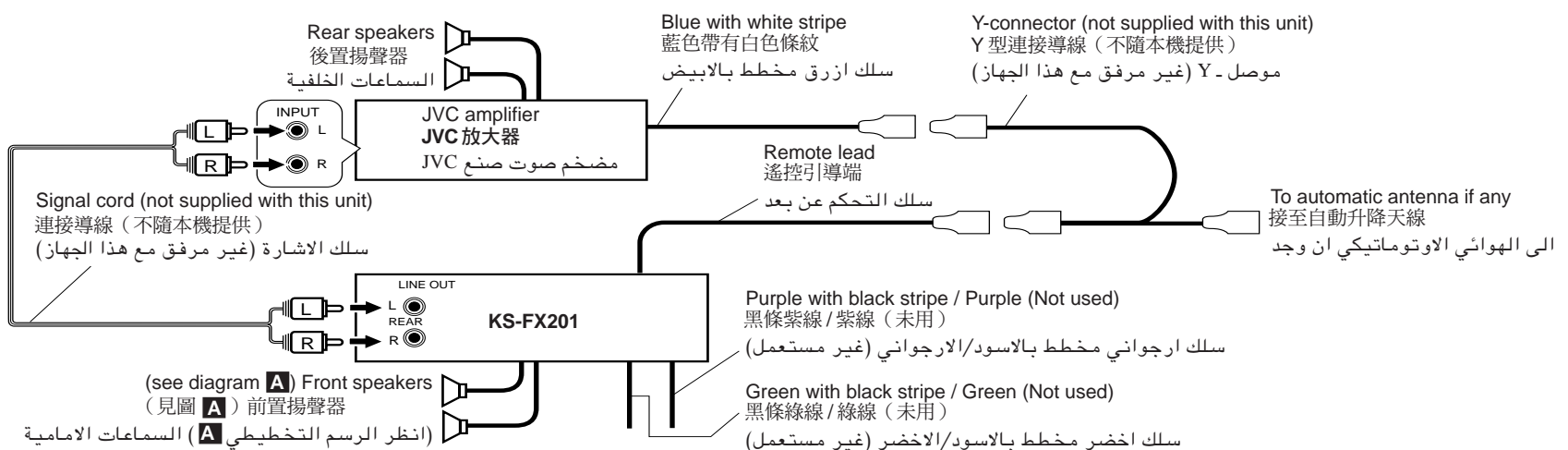

TROUBLESHOOTING

- **The fuse blows.**
 - * Are the red and black leads connected correctly?
- **Power cannot be turned on.**
 - * Is the yellow lead connected?
- **No sound from the speakers.**
 - * Is the speaker output lead short-circuited?
- **Sound is distorted.**
 - * Is the speaker output lead grounded?
 - * Are the “-” terminals of L and R speakers grounded in common?
- **Unit becomes hot.**
 - * Is the speaker output lead grounded?
 - * Are the “-” terminals of L and R speakers grounded in common?

故障排除

- 保險絲燒斷。
 - * 檢查紅色導線接頭和黑色導線接頭是否連接正確？
- 電源不能接通。
 - * 檢查黃色導線接頭是否接上？
- 揚聲器沒有聲音。
 - * 檢查揚聲器輸出導線接頭是否短路？
- 聲音失真。
 - * 檢查揚聲器輸出端子是否接地？
 - * 檢查揚聲器的左（L）、右（R）端子的負極（-）是否共同接地？
- 本機發熱。
 - * 檢查揚聲器輸出端子是否接地？
 - * 檢查揚聲器的左（L）、右（R）端子的負極（-）是否共同接地？

البحث عن الاعطال والاصلاح

- **يحترق الفيوز.**
 - * هل السلك الاحمر والاسود موصولة بشكل صحيح؟
- **لا يمكن توصيل الطاقة الكهربائية.**
 - * هل السلك الاصفر موصولاً؟
- **لا يصدر صوت من السماعات.**
 - * هل هنالك تقصير في دائرة سلك خرج السماعة؟
- **الصوت مشوه.**
 - * هل سلك خرج السماعة موصولاً بالارض؟
 - * هل الاطراف السالبة «-» للسماعة اليسرى L واليمنى R موصولة بالارض مع بعض؟
- **يسخن الجهاز.**
 - * هل سلك خرج السماعة موصولاً بالارض؟
 - * هل الاطراف السالبة «-» للسماعة اليسرى L واليمنى R موصولة بالارض مع بعض؟

Free Manuals Download Website

<http://myh66.com>

<http://usermanuals.us>

<http://www.somanuals.com>

<http://www.4manuals.cc>

<http://www.manual-lib.com>

<http://www.404manual.com>

<http://www.luxmanual.com>

<http://aubethermostatmanual.com>

Golf course search by state

<http://golfingnear.com>

Email search by domain

<http://emailbydomain.com>

Auto manuals search

<http://auto.somanuals.com>

TV manuals search

<http://tv.somanuals.com>