

JVC



COMPACT COMPONENT SYSTEM

MX-GT88 — Consists of CA-MXGT88 and SP-MXGT88

MX-GA77 — Consists of CA-MXGA77 and SP-MXGA77

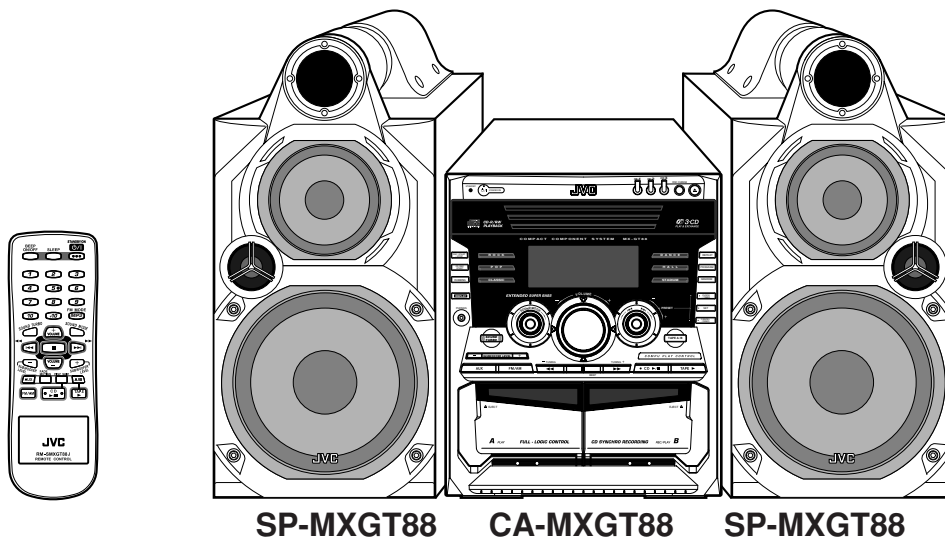

COMPACT
disc
DIGITAL AUDIO

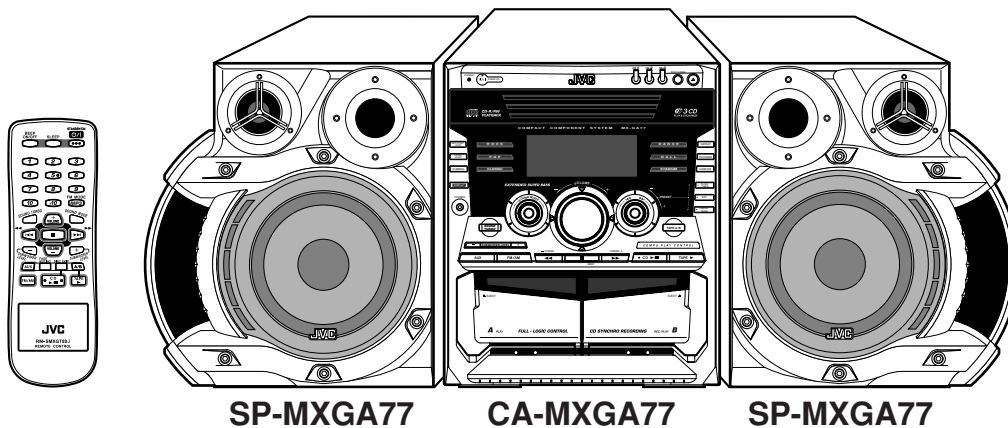

COMPACT
disc
DIGITAL AUDIO

INSTRUCTIONS

For Customer Use:

Enter below the Model No. and Serial No. which are located either on the rear, bottom or side of the cabinet. Retain this information for future reference.

Model No. _____

Serial No. _____

LVT1010-001B

[J]

Warnings, Cautions and Others

Mises en garde, précautions et indications diverses

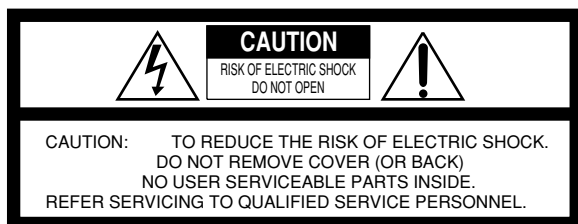

The lightning flash with arrowhead symbol, within an equilateral triangle is intended to alert the user to the presence of uninsulated "dangerous voltage" within the product's enclosure that may be of sufficient magnitude to constitute a risk of electric shock to persons.



The exclamation point within an equilateral triangle is intended to alert the user to the presence of important operating and maintenance (servicing) instructions in the literature accompanying the appliance.

WARNING: TO REDUCE THE RISK OF FIRE OR ELECTRIC SHOCK, DO NOT EXPOSE THIS APPLIANCE TO RAIN OR MOISTURE.

For U.S.A.

This equipment has been tested and found to comply with the limits for a Class B digital device, pursuant to part 15 of the FCC Rules. These limits are designed to provide reasonable protection against harmful interference in a residential installation.

This equipment generates, uses and can radiate radio frequency energy and, if not installed and used in accordance with the instructions, may cause harmful interference to radio communications. However, there is no guarantee that interference will not occur in a particular installation. If this equipment does cause harmful interference to radio or television reception, which can be determined by turning the equipment off and on, the user is encouraged to try to correct the interference by one or more of the following measures:

Reorient or relocate the receiving antenna.
Increase the separation between the equipment and receiver.
Connect the equipment into an outlet on a circuit different from that to which the receiver is connected.
Consult the dealer or an experienced radio/TV technician for help.

CAUTION

To reduce the risk of electrical shocks, fire, etc.:

1. Do not remove screws, covers or cabinet.
2. Do not expose this appliance to rain or moisture.

ATTENTION

Afin d'éviter tout risque d'électrocution, d'incendie, etc.:

1. Ne pas enlever les vis ni les panneaux et ne pas ouvrir le coffret de l'appareil.
2. Ne pas exposer l'appareil à la pluie ni à l'humidité.

Caution — ⏻/I STANDBY/ON switch!

Disconnect the mains plug to shut the power off completely. The ⏻/I STANDBY/ON switch in any position does not disconnect the mains line. The power can be remote controlled.

Attention — Commutateur ⏻/I STANDBY/ON!

Déconnecter la fiche de secteur pour couper complètement le courant. Le commutateur ⏻/I STANDBY/ON ne coupe jamais complètement la ligne de secteur, quelle que soit sa position. Le courant peut être télécommandé.

1. CLASS 1 LASER PRODUCT
2. **CAUTION:** Invisible laser radiation when open and interlock failed or defeated. Avoid direct exposure to beam.
3. **CAUTION:** Do not open the top cover. There are no user serviceable parts inside the Unit; leave all servicing to qualified service personnel.

1. PRODUIT LASER CLASSE 1
2. **ATTENTION:** Radiation laser invisible quand l'appareil est ouvert ou que le verrouillage est en panne ou désactivé. Éviter une exposition directe au rayon.
3. **ATTENTION:** Ne pas ouvrir le couvercle du dessus. Il n'y a aucune pièce utilisable à l'intérieur. Laisser à un personnel qualifié le soin de réparer votre appareil.

For Canada/pour le Canada

CAUTION: TO PREVENT ELECTRIC SHOCK, MATCH WIDE BLADE OF PLUG TO WIDE SLOT, FULLY INSERT.

ATTENTION: POUR EVITER LES CHOCS ELECTRIQUES, INTRODUIRE LA LAME LA PLUS LARGE DE LA FICHE DANS LA BORNE CORRESPONDANTE DE LA PRISE ET POUSSER JUSQU'AU FOND.

For Canada/pour le Canada

THIS DIGITAL APPARATUS DOES NOT EXCEED THE CLASS B LIMITS FOR RADIO NOISE EMISSIONS FROM DIGITAL APPARATUS AS SET OUT IN THE INTERFERENCE-CAUSING EQUIPMENT STANDARD ENTITLED "DIGITAL APPARATUS," ICES-003 OF THE DEPARTMENT OF COMMUNICATIONS.

CET APPAREIL NUMERIQUE RESPECTE LES LIMITE DE BRUITS RADIOELECTRIQUES APPLICABLES AUX APPAREILS NUMIRIQUES DE CLASSE B PRESCRITES DANS LA NORME SUR LE MATERIEL BROUILLEUR: "APPAREILS NUMERIQUES", NMB-003 EDICTEE PAR LE MINISTRE DES COMMUNICATIONS.

Caution: Proper Ventilation

To avoid risk of electric shock and fire, and to prevent damage, locate the apparatus as follows:

- 1 Front:
No obstructions and open spacing.
- 2 Sides/ Top/ Back:
No obstructions should be placed in the areas shown by the dimensions below.
- 3 Bottom:
Place on the level surface. Maintain an adequate air path for ventilation by placing on a stand with a height of 10 cm or more.

Attention: Aération correcte

Pour prévenir tout risque de décharge électrique ou d'incendie et éviter toute détérioration, installez l'appareil de la manière suivante:

- 1 Avant:
Bien dégagé de tout objet.
- 2 Côtés/dessus/dessous:
Assurez-vous que rien ne bloque les espaces indiqués sur le schéma ci-dessous.
- 3 Dessous:
Posez l'appareil sur une surface plane et horizontale. Veillez à ce que sa ventilation correcte puisse se faire en le plaçant sur un support d'au moins dix centimètres de hauteur.

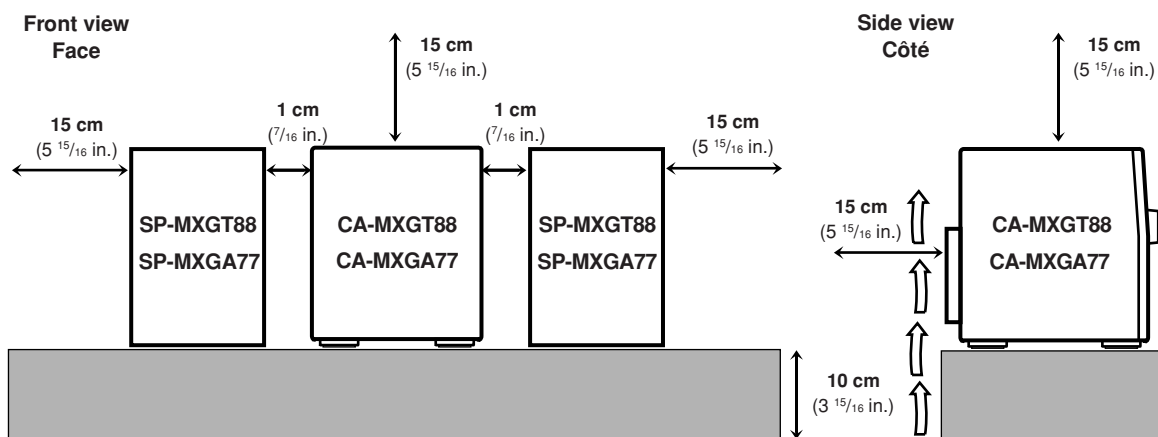

Introduction

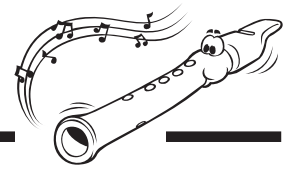

We would like to thank you for purchasing one of our JVC products. Before operating this unit, read this manual carefully and thoroughly to obtain the best possible performance from your unit, and retain this manual for future reference.

About This Manual

This manual is organized as follows:

- The manual mainly explains operations using the buttons and controls on the unit. You can also use the buttons on the remote control if they have the same or similar names (or marks) as those on the unit. If operation using the remote control is different from that using the unit, it is then explained.
- Basic and common information that is the same for many functions is grouped in one place, and is not repeated in each procedure. For instance, we do not repeat the information about turning on/off the unit, setting the volume, changing the sound effects, and others, which are explained in the section “Common Operations” on pages 9 to 11.
- The following marks are used in this manual:



Gives you warnings and cautions to prevent damage or risk of fire/electric shock. Also gives you information which is not good for obtaining the best possible performance from the unit.



Gives you information and hints you had better know.

Precautions

Installation

- Do not grasp the control knobs when moving or carrying the unit.
- Install in a place which is level, dry and neither too hot nor too cold—between 5°C (41°F) and 35°C (95°F).
- Install the unit in a location with adequate ventilation to prevent internal heat built-up in the unit.
- Leave sufficient distance between the unit and the TV.
- Keep the speakers away from the TV to avoid interference with TV.



DO NOT install the unit in a location near heat sources, or in a place subject to direct sunlight, excessive dust or vibration.

Power sources

- When unplugging from the wall outlet, always pull the plug, not the AC power cord.



DO NOT handle the AC power cord with wet hands.

Moisture condensation

Moisture may condense on the lens inside the unit in the following cases:

- After starting heating in the room
 - In a damp room
 - If the unit is brought directly from a cold to a warm place
- Should this occur, the unit may malfunction. In this case, leave the unit turned on for a few hours until the moisture evaporates, unplug the AC power cord, and then plug it in again.

Others

- Should any metallic object or liquid fall into the unit, unplug the unit and consult your dealer before operating any further.
- If you are not going to operate the unit for an extended period of time, unplug the AC power cord from the wall outlet.



DO NOT disassemble the unit since there are no user serviceable parts inside.

If anything goes wrong, unplug the AC power cord and consult your dealer.

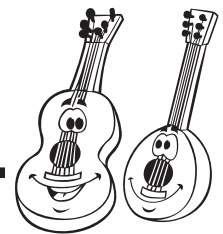

Location of the Buttons and Controls	3
Front Panel	3
Remote Control	5
Getting Started	6
Unpacking	6
Putting the Batteries into the Remote Control	6
Connecting Antennas	6
Connecting Speakers	7
Connecting Other Equipment	8
Canceling the Display Demonstration	8
Common Operations	9
Turning On or Off the Power	9
Setting the Clock	9
Selecting the Sources	9
Adjusting the Volume	10
Reinforcing the Bass Sound	10
Enjoying the Heavy Sound	10
Selecting the Sound Modes	11
Turning On or Off the Key-touch Tone	11
Listening to the Radio	12
Tuning in to a Station—Auto Search	12
Presetting Stations	12
Tuning in to a Preset Station	12
Playing Back CDs	13
Loading CDs	13
Playing Back CDs—All Disc and One Disc	13
Basic CD Operations	15
Changing the MP3 Playback Mode	17
Turning On or Off the Resume Play for MP3 Disc ..	17
Programming the Playing Order of the Tracks —Program Play	18
Playing at Random—Random Play	19
Repeating Tracks or CDs—Repeat Play	19
Prohibiting Disc Ejection—Carrousel Lock	19
Playing Back Tapes	20
Playing Back a Tape	20
Recording	21
Recording a Tape on Deck B	21
Dubbing Tapes	22
CD Synchronized Recording	22
Using the Timers	23
Using Daily Timer	23
Using Recording Timer	24
Using Sleep Timer	25
Timer Priority	25
Maintenance	26
Troubleshooting	27
Specifications	28

Location of the Buttons and Controls

Become familiar with the buttons and controls on your unit.

Front Panel

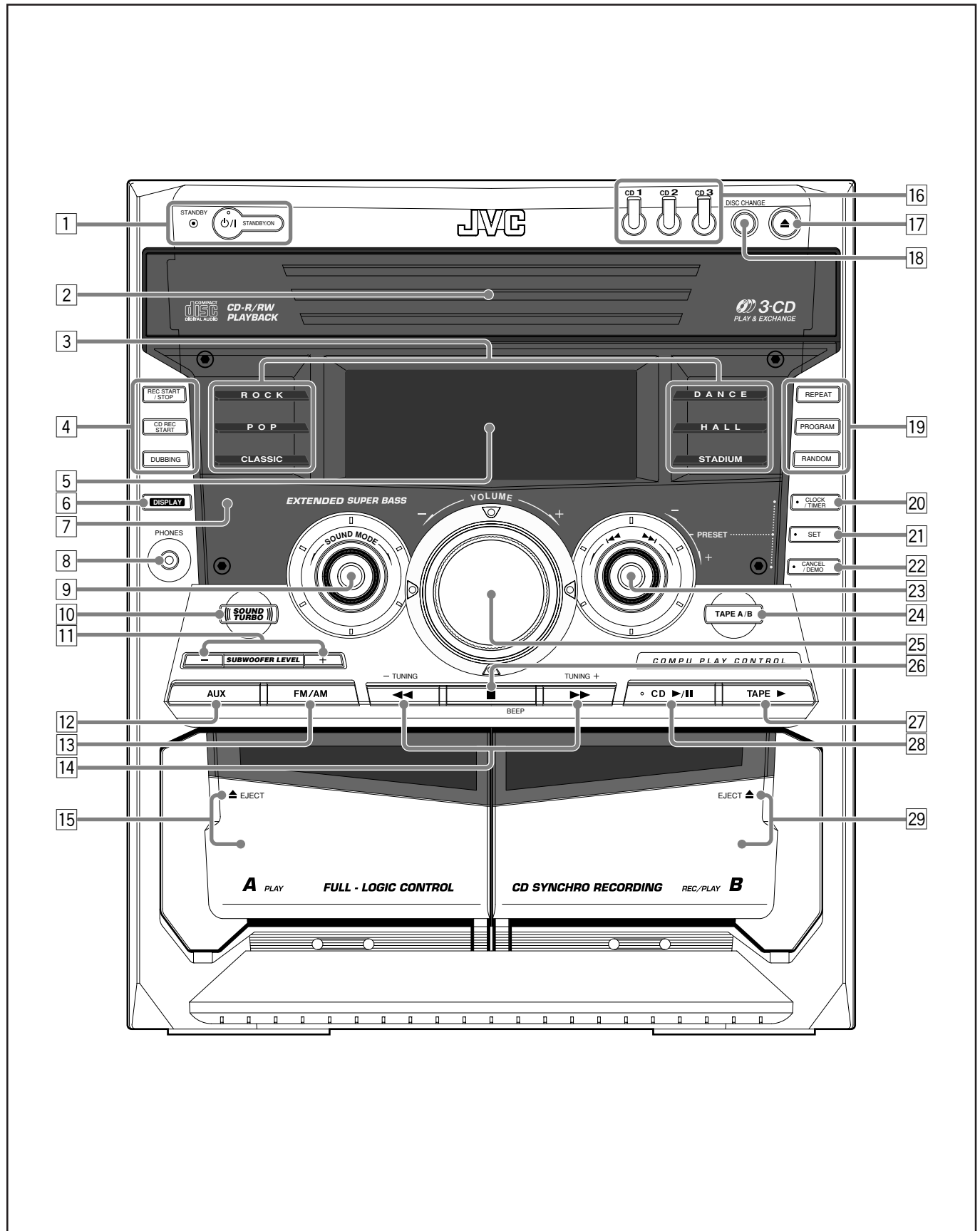

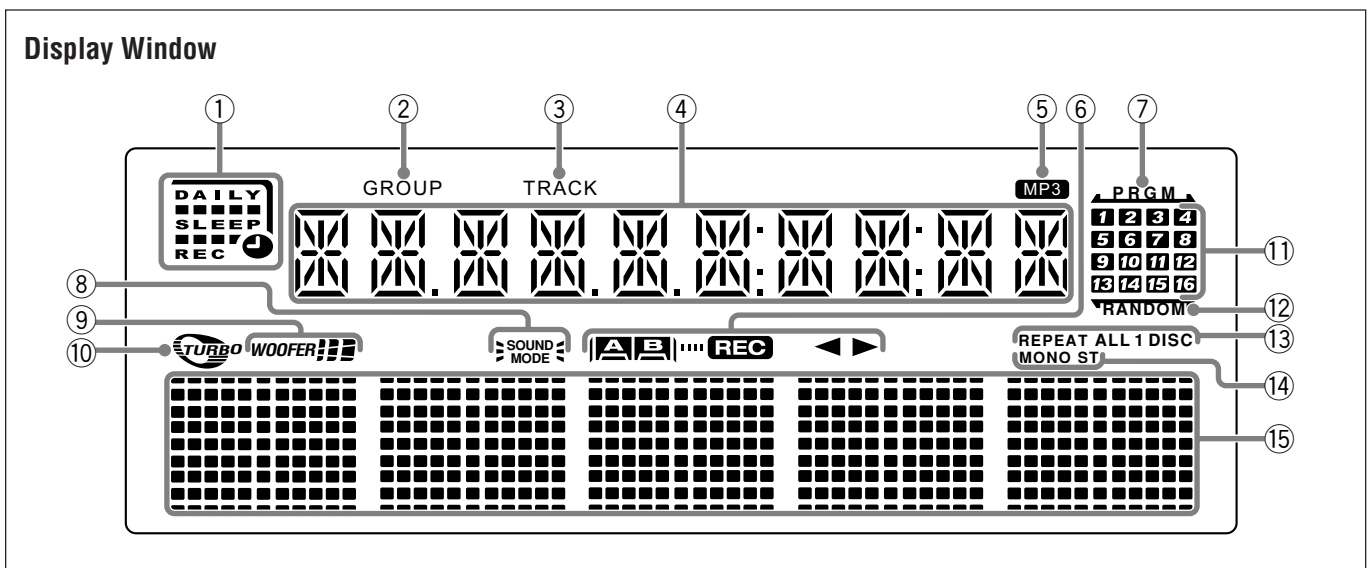

See pages in the parentheses for details.

Front Panel

- 1 **⏻/⏻** STANDBY/ON button and STANDBY lamp (9, 24, 25)
- 2 Carrousel
- 3 Sound mode lamps (11)
- 4 REC START/STOP button (21)
CD REC START button (22)
DUBBING button (22)
- 5 Display window
- 6 DISPLAY button (9)
- 7 Remote sensor
- 8 PHONES jack (10)
- 9 SOUND MODE control (11)
- 10 SOUND TURBO button (10)
- 11 SUBWOOFER LEVEL +/- buttons (10)
- 12 AUX button (9)
Pressing this button also turns on the unit.
- 13 FM/AM button (9, 12)
Pressing this button also turns on the unit.
- 14 TUNING +/- buttons (12)
◀◀ / ▶▶ (fast rewind/fast forward) buttons (15, 20)
- 15 Deck A cassette holder (20, 22)
Pressing the ▲ EJECT portion opens the holder.
- 16 Disc number buttons and lamps (CD1, CD2, and CD3) (14, 15, 18, 19, 22)
Pressing one of these buttons also turns on the unit.
- 17 ▲ (Carrousel open/close) button (13 – 15, 17 – 19)
Pressing this button also turns on the unit.
- 18 DISC CHANGE button (13, 15)
- 19 REPEAT button (13, 15, 19)
PROGRAM (MP3 Resume on/off) button (17, 18)
RANDOM button (19)
- 20 CLOCK/TIMER button (9, 23 – 25)
- 21 SET button (9, 12, 18, 23 – 25)
- 22 CANCEL/DEMO button (8, 9, 18, 24, 25)

- 23 PRESET +/- control (12)
◀◀/▶▶ (reverse search/forward search) control (9, 15 – 19, 23 – 25)
- 24 TAPE A/B button (20)
- 25 VOLUME control (10)
- 26 ■ (stop) button (13 – 15, 18 – 22)
BEEP button (11)
- 27 TAPE ▶ (play) button (9, 20, 22)
Pressing this button also turns on the unit.
- 28 CD ▶/|| (play/pause) button (9, 13 – 15, 18)
Pressing this button also turns on the unit.
- 29 Deck B cassette holder (20 – 22, 24)
Pressing the EJECT ▲ portion opens the holder.

Display window

- 1 Timer indicators
 - DAILY (daily timer), SLEEP (sleep timer), REC (recording timer), and ⏻ (timer) indicators
- 2 GROUP indicator
- 3 TRACK indicator
- 4 Main display
 - Shows the source name, frequency, etc.
- 5 MP3 indicator
- 6 Tape operation indicators
 - A/B (operating deck), REC (recording), and ◀▶ (tape running) indicators
- 7 PRGM (program) indicator
- 8 SOUND MODE indicator
- 9 WOOFER indicator
- 10 TURBO indicator
- 11 CD track number indicators
- 12 RANDOM indicator
- 13 REPEAT mode indicators
 - REPEAT, 1, 1 DISC, ALL DISC indicators
- 14 Tuner operation indicators
 - MONO and ST (stereo) indicators
- 15 Volume level, Subwoofer level and Sound Mode pattern indicators



Remote Control

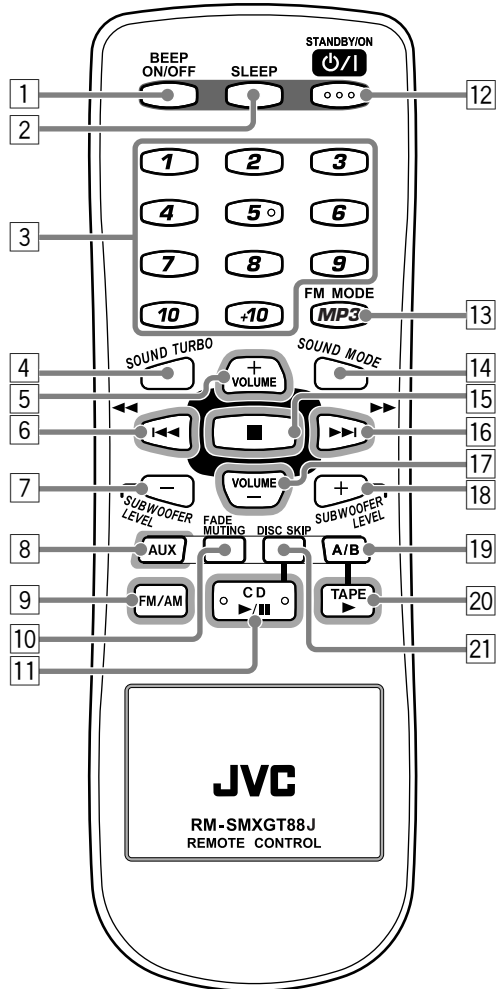

Remote Control

- 1 BEEP ON/OFF button (11)
- 2 SLEEP button (25)
- 3 Number buttons (12, 16)
- 4 SOUND TURBO button (10)
- 5 VOLUME + button (10)
- 6 ◀◀/◀◀ (reverse search/fast rewind) button (12, 15 – 17, 19, 20)
- 7 SUBWOOFER LEVEL – button (10)
- 8 AUX button (9)
Pressing this button also turns on the unit.
- 9 FM/AM button (9, 12)
Pressing this button also turns on the unit.
- 10 FADE MUTING button (10)
- 11 CD ▶/|| (play/pause) button (9, 13 – 15, 18)
Pressing this button also turns on the unit.
- 12 ◻/I STANDBY/ON button (9)
- 13 FM MODE button (12)
MP3 button (17)
- 14 SOUND MODE button (11)
- 15 ■ (stop) button (13 – 15, 18 – 22)
- 16 ▶▶/▶▶ (forward search/fast forward) button (12, 15 – 17, 19, 20)
- 17 VOLUME – button (10)
- 18 SUBWOOFER LEVEL + button (10)
- 19 A/B button (20)
- 20 TAPE ▶ (play) button (9, 20)
Pressing this button also turns on the unit.
- 21 DISC SKIP button (13, 15)

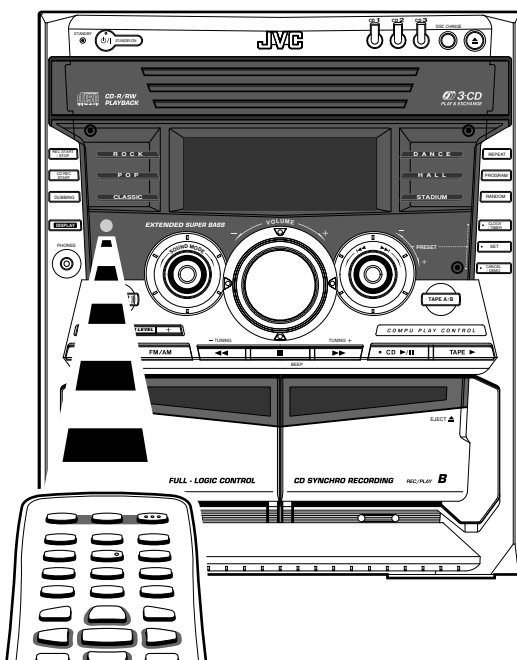

When using the remote control, point it at the remote sensor on the front panel.

Unpacking

After unpacking, check to be sure that you have all the following items.
The number in the parentheses indicates the quantity of the pieces supplied.

- AM loop antenna (1)
- FM antenna (1)
- Remote control (1)
- Batteries (2)

If any is missing, consult your dealer immediately.

Putting the Batteries into the Remote Control

Insert the batteries—R6P(SUM-3)/AA(15F)—into the remote control, by matching the polarity (+ and –) on the batteries with the + and – markings on the battery compartment. When the remote control can no longer operate the unit, replace both batteries at the same time.

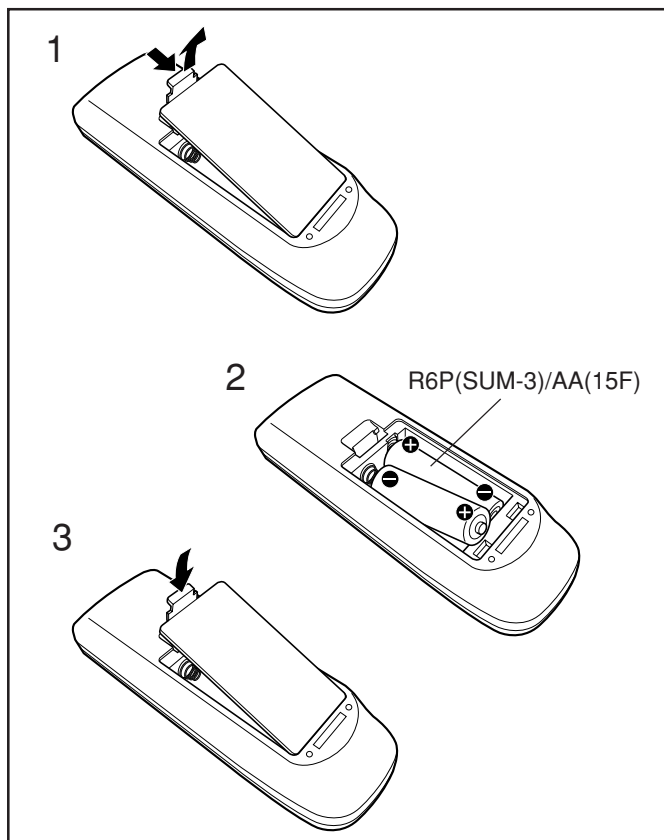

- DO NOT use an old battery together with a new one.
- DO NOT use different types of batteries together.
- DO NOT expose batteries to heat or flame.
- DO NOT leave the batteries in the battery compartment when you are not going to use the remote control for an extended period of time. Otherwise, it will be damaged from battery leakage.

Connecting Antennas

FM antenna

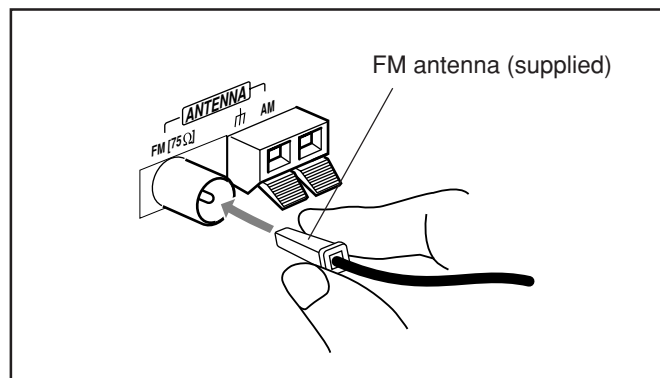

- 1 Attach the FM antenna to the FM [75 Ω] coaxial terminal.**
- 2 Extend the FM antenna.**
- 3 Fasten it up in the position which gives you the best reception, then fix it on the wall, etc.**



About the supplied FM antenna

The FM antenna supplied with this unit can be used as temporary measure. If reception is poor, you can connect an outdoor FM antenna.

To connect an outdoor FM antenna

Before connecting it, disconnect the supplied FM antenna.

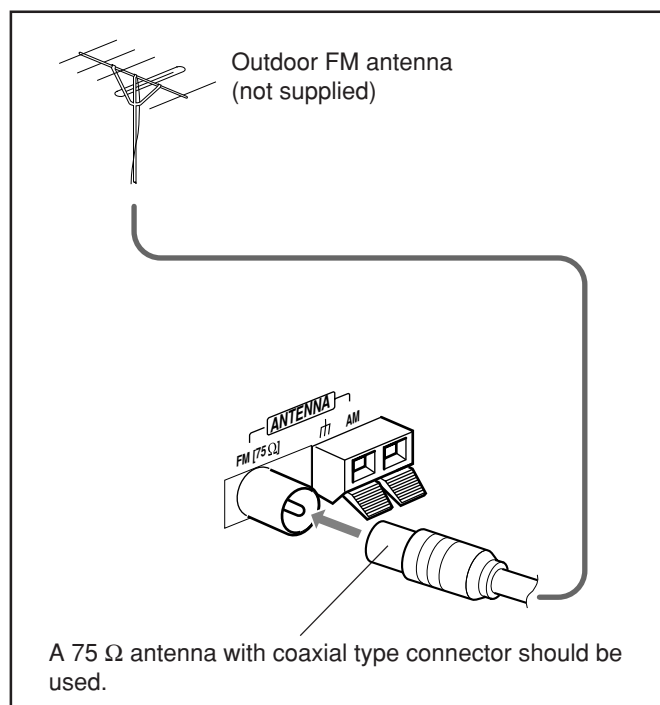

A 75 Ω antenna with coaxial type connector should be used.

AM antenna

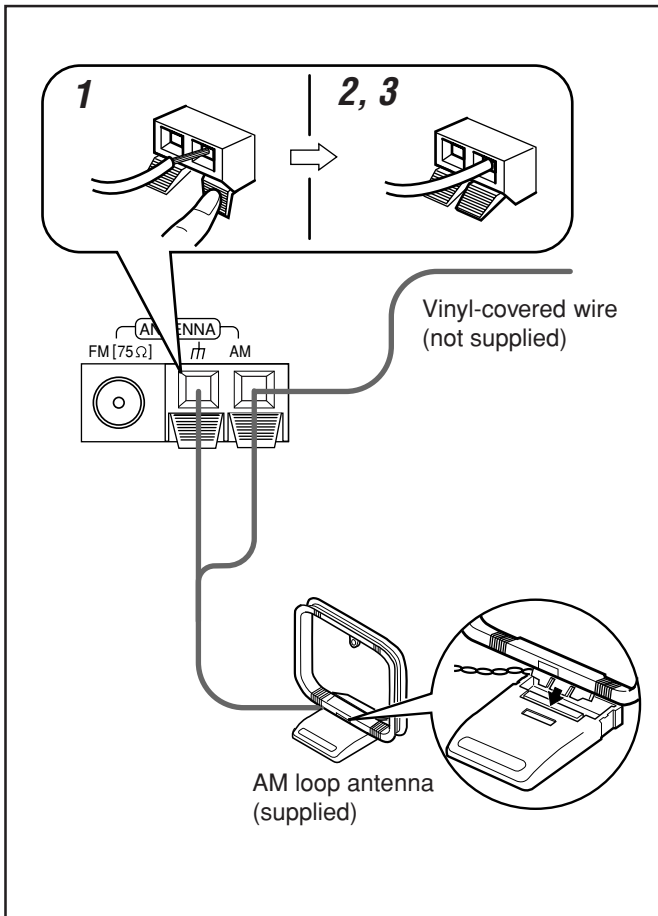

1 Press and hold the clamp of the AM terminal on the rear of the unit.

2 Insert the end of the AM loop antenna cord into the terminal.

- If the AM loop antenna wire is covered with vinyl, remove the vinyl by twisting it as shown in the diagram.

3 Release the finger from the clamp.

4 Turn the AM loop antenna until you have the best reception.

To connect an outdoor AM antenna

When reception is poor, connect a single vinyl-covered wire to the AM terminal and extend it horizontally. (The AM loop antenna must remain connected.)



For better reception of both FM and AM

- Make sure the antenna conductors do not touch any other terminals and connecting cords.
- Keep the antennas away from metallic parts of the unit, connecting cords, and the AC power cord.

Connecting Speakers



For MX-GT88:

DO NOT carry the speaker by holding the tube duct (on the top of the speaker).

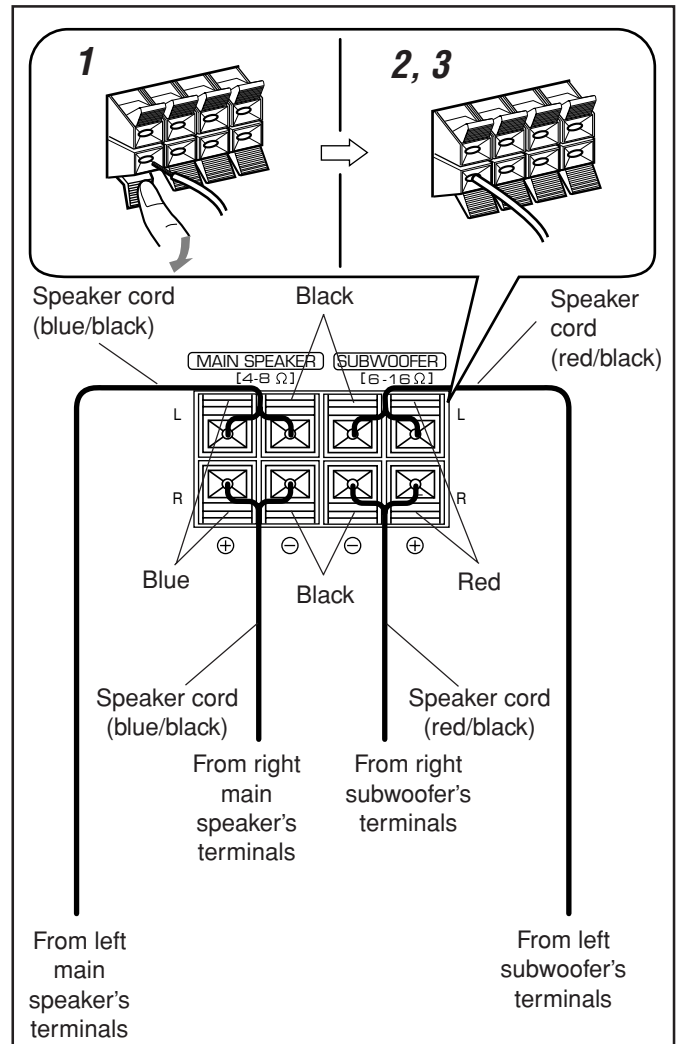

1 Press and hold the clamp of the speaker terminal on the rear of the unit.

2 Insert the end of the speaker cord into the terminal.

Match the colors (polarity): Blue (+) to blue (+) and black (-) to black (-); red (+) to red (+) and black (-) to black (-).

- If the wire is covered with vinyl, remove the vinyl by twisting it as shown in the diagram.

3 Release the finger from the clamp.

IMPORTANT:

- Use only speakers with the same speaker impedance as indicated by the speaker terminals on the rear of the unit.
- **DO NOT** connect more than one speaker to one speaker terminal.



Connecting Other Equipment

You can connect audio equipment—used only as a playback device.



- DO NOT connect any equipment while the power is on.
- DO NOT plug in any equipment until all connections are complete.

To connect audio equipment

Be sure that the plugs of the audio cords are color coded: White plugs and jacks are for left audio signals, and red ones for right audio signals.

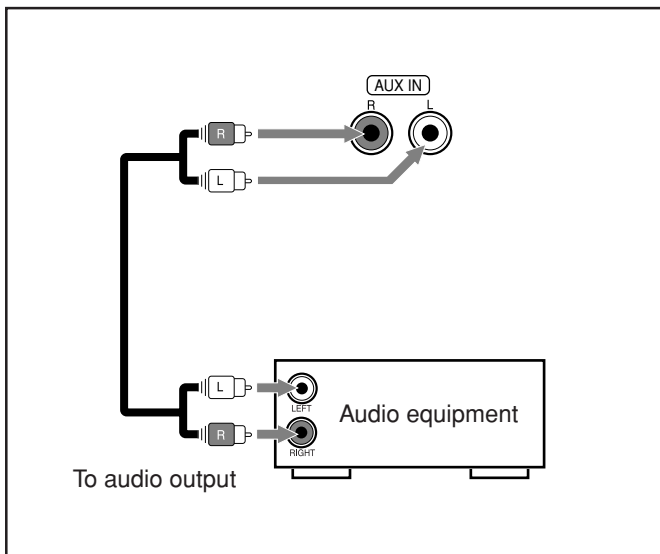

For playing the other equipment through this unit, connect between the audio output jacks on the other equipment and AUX IN jacks by using audio cords (not supplied).

NOW you are ready to plug in the unit and other connected equipment.

Canceling the Display Demonstration

When connecting the AC power cord into a wall outlet, the unit automatically starts the display demonstration.

On the unit ONLY:

To cancel the display demonstration, press CANCEL/DEMO while the display demonstration is shown on the display.

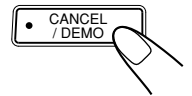

When you press other buttons

The display demonstration stops temporarily. It will start automatically again (if no operation is done for 2 minutes) until you cancel it.

To start the display demonstration manually

Press and hold CANCEL/DEMO again for more than 2 seconds.

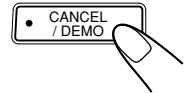

Common Operations

Turning On or Off the Power

To turn on the unit, press STANDBY/ON so that the STANDBY lamp goes off.

POWER ON

To turn off the unit (on standby), press STANDBY/ON again so that the STANDBY lamp lights up.

A little power is always consumed even while the unit is on standby.

To switch off the power supply completely, unplug the AC power cord from the AC outlet.

notes When you unplug the AC power cord or if a power failure occurs

The clock is reset to “-- : --” soon, while the tuner preset stations (see page 12) will be erased in a few days.

Setting the Clock

Before operating the unit any further, first set the clock built in this unit. You can set the clock whether the unit is on or off.

On the unit ONLY:

1 Press CLOCK/TIMER.

AM 12:00

The hour digits start flashing on the display.

2 Turn the control to adjust the hour, then press SET.

AM 7:00

The minute digits start flashing on the display.

- If you want to correct the hour after pressing SET, press CANCEL/DEMO. The hour digits start flashing again.

3 Turn the control to adjust the minute, then press SET.

CLOCK OK

To check the clock time

Press DISPLAY while playing any source.

- Each time you press the button, the source indication and the clock time alternate on the display.

To adjust the clock again

If you have adjusted the clock before, you need to press CLOCK/TIMER repeatedly until “CLOCK” is selected.

- Each time you press the button, the clock/timer setting modes change as follows:

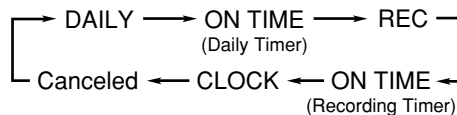

notes If there is a power failure

The clock loses the setting and is reset to “-- : --.” You need to set the clock again.

Selecting the Sources

To listen to the radio, press FM/AM. (See page 12.)

To play back CDs, press CD .

To play back tapes, press TAPE .

To select the external equipment as the source, press AUX.

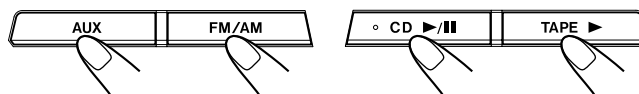

When you press the play button for a particular source (AUX, FM/AM, CD , and TAPE , the unit turns on (and the unit starts playing the source if it is ready—COMPU PLAY CONTROL).

Adjusting the Volume

You can adjust the volume level only while the unit is turned on.

This function only affects the playback sound, not your recording.

Turn the **VOLUME** control clockwise to increase the volume or counterclockwise to decrease it.

- The volume level can be adjusted in 32 steps (VOL MIN, VOL 1 — VOL 30, and VOL MAX).

VOL 14

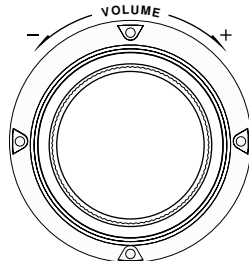

When using the remote control, press **VOLUME +** to increase the volume or press **VOLUME -** to decrease it.



For private listening

Connect a pair of headphones to the PHONES jack. No sound comes out of the speakers. Be sure to turn down the volume before connecting or putting on headphones.



DO NOT turn off (on standby) the unit with the volume set to an extremely high level; otherwise, a sudden blast of sound can damage your hearing, speakers and/or headphones when you turn on the unit or start playing any source next time. REMEMBER you cannot adjust the volume level while the unit is on standby.

To turn down the volume level temporarily

Press **FADE MUTING** on the remote control. The volume level gradually decreases to "VOL MIN."

To restore the sound, press the button again.



Reinforcing the Bass Sound

This function only affects the playback sound, not your recording.

Press **SUBWOOFER LEVEL +** to increase the subwoofer sound or **SUBWOOFER LEVEL -** to decrease it.

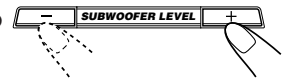

- The subwoofer level can be adjusted in 3 steps (LEVEL 1 — LEVEL 3).

If you press **SUBWOOFER LEVEL +** to increase the level up to LEVEL 3, "MAX LEVEL" appears on the display.

WOOFER indicator also shows the current subwoofer level.

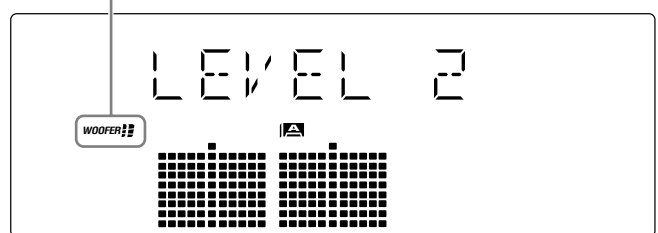

Enjoying the Heavy Sound

You can enjoy the heavy sound by using the sound turbo. The function boosts the low and high frequency sound. This function only affects the playback sound, not your recording.

Press **SOUND TURBO**.

The TURBO indicator lights up on the display.

- Each time you press **SOUND TURBO**, the sound turbo turns on and off alternately.



TURBO indicator

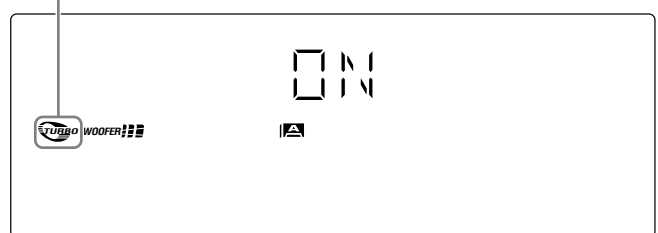

When you turn off the sound turbo

The subwoofer level is set to LEVEL 1.



When the sound turbo is on

Turning the **SOUND MODE** control (or pressing **SOUND MODE** on the remote control) cancels the sound turbo.



Selecting the Sound Modes

This function only affects the playback sound, not your recording.

You can select one of the 6 preset sound modes (3 surround modes and 3 SEA—Sound Effect Amplifier—modes).

To select the sound modes, turn the SOUND MODE control until the sound mode you want appears on the display.

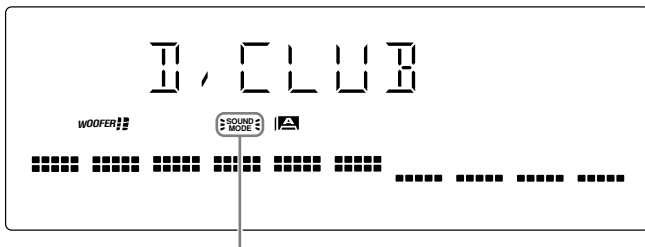

SOUND MODE indicator also lights up on the display

- As you turn the control, the sound modes change as follows:

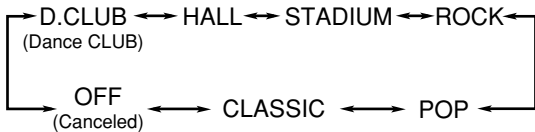

Surround modes*:

- D.CLUB** : Increases resonance and bass.
- HALL** : Adds depth and brilliance to the sound.
- STADIUM**: Adds clarity and spreads the sound, like in an outdoor stadium.

SEA (Sound Effect Amplifier) modes:

- ROCK** : Boosts low and high frequency. Good for acoustic music.
- POP** : Good for vocal music.
- CLASSIC** : Good for classical music.
- OFF** : Cancels the sound mode.

* Surround elements are added to the SEA elements to create being-there feeling in your room.

When one of these modes is selected, the SOUND MODE indicator lights up as .

While one of the SEA modes (SEA elements without surround elements) is selected, the SOUND MODE indicator lights up as .

- The corresponding sound mode lamp also flashes.



When the sound mode is set to OFF

All sound mode indicators do not flash but light up.

When using the remote control, press SOUND MODE to select the sound mode.

- Each time you press the button, the sound modes change as follows:

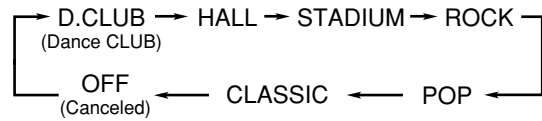

When the sound mode is activated

Pressing SOUND TURBO cancels the sound mode (set to OFF).

Turning On or Off the Key-touch Tone

If you do not want the key-touch tone to beep each time you press a button or turn a control, you can deactivate it.

- You can turn on or off the key-touch tone as follows:
 - When the unit is off:
 - You can turn on or off the key-touch tone by operating the unit.
 - When the unit is on:
 - You can turn on or off the key-touch tone by operating the unit or the remote control.

On the unit:

Press and hold BEEP for more than 2 seconds.

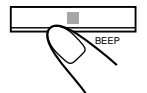

BEEP OFF

- Each time you press and hold the button, the key-touch tone turns on and off alternately.

On the remote control:

Press BEEP ON/OFF when the unit is on.

- Each time you press the button, the key-touch tone turns on and off alternately.

BEEP ON/OFF



Listening to the Radio



Tuning in to a Station—Auto Search

1 Press FM/AM.

The unit automatically turns on and tunes in to the previously tuned station (either FM or AM).

- Each time you press the button, the band alternates between FM and AM.

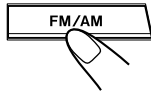

2 Start searching for stations.

On the unit:

Press and hold **TUNING +** or **TUNING -** for more than 1 second.

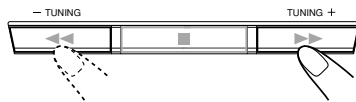

On the remote control:

Press and hold **◀◀◀/▶▶▶** or **▶▶▶/▶▶▶** for more than 1 second.

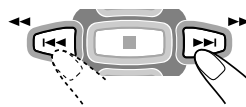

The unit starts searching for stations and stops when a station of sufficient signal strength is tuned in to. If a program is broadcast in stereo, the ST (stereo) indicator lights up.

To stop during searching, press **TUNING +** or **TUNING -** (or **◀◀◀/▶▶▶** or **▶▶▶/▶▶▶** on the remote control).

notes When you press **TUNING +** or **TUNING -** (or **◀◀◀/▶▶▶** or **▶▶▶/▶▶▶** on the remote control) briefly and repeatedly

The frequency changes step by step.

To change the FM reception mode

When an FM stereo broadcast is hard to receive or noisy, press **FM MODE** on the remote control so that “MONO” appears and the MONO indicator also lights up on the display. Reception improves.



To restore the stereo effect, press **FM MODE** again so that “STEREO” appears on the display.

In this stereo mode, you can hear stereo sounds when a program is broadcast in stereo.

Presetting Stations

You can preset 30 FM and 15 AM stations.

In some cases, test frequencies have been already memorized for the tuner since the factory examined the tuner preset function before shipment. This is not a malfunction. You can preset the stations you want into memory by following the presetting method.

- There is a time limit in doing the following steps. If the setting is canceled before you finish, start from step 2 again.

On the unit ONLY:

1 Tune in to the station you want to preset (in this example, of FM 87.50).

- See “Tuning in to a Station—Auto Search.”

FM 87.50

2 Press SET.

SET

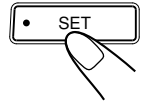

3 Turn the PRESET +/- control to select a preset number.

P-01

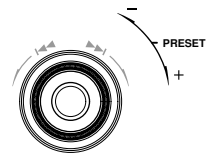

4 Press SET again.

STORED

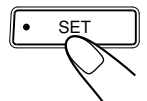

The tuned station in step 1 is stored in the preset number selected in step 3.

- Storing a new station on a used number erases the previously stored one.

notes When you unplug the AC power cord or if a power failure occurs

The preset stations will be erased in a few days. If this happens, preset the stations again.

Tuning in to a Preset Station

1 Press FM/AM.

The unit automatically turns on and tunes in to the previously tuned station (either FM or AM).

- Each time you press the button, the band alternates between FM and AM.

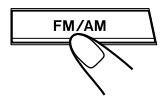

2 Select a preset number.

On the unit:

Turn the **PRESET +/-** control.

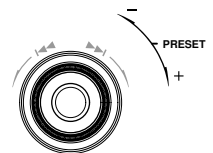

On the remote control:

Press the number buttons.

Ex.: For preset number 5, press 5.

For preset number 15,

press +10 then 5.

For preset number 20,

press +10, then 10.

For preset number 25, press +10, +10, then 5.

For preset number 30, press +10, +10, then 10.

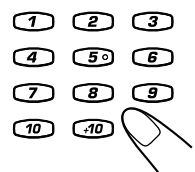

Playing Back CDs

This unit has been designed to playback the following CDs:

- Audio CD
- CD-R (CD-Recordable)
- CD-RW (CD-ReWritable)
- MP3 disc (MP3 files recorded on a CD-R or CD-RW)*

When playing a CD-R or CD-RW

- User-edited CD-Rs (CD-Recordable) and CD-RWs (CD-ReWritable) can be played back when they are already “finalized.”
- Before playing back CD-Rs or CD-RWs, read their instructions or cautions carefully.
- Some CD-Rs or CD-RWs may not be played back on this unit because of their disc characteristics, damage or stain on them, or if the player’s lens is dirty.

Important notices:

- In general, you will have the best performance by keeping your CDs and the mechanism clean.
 - Store CDs in their cases, and keep them in cabinets or on shelves.
 - Keep the unit’s carrousel closed when not in use.
- Continuous use of irregular shaped discs (heart-shape, octagonal, etc.) can damage the disc rotating mechanism.



- CD-RWs may require a longer readout time since the reflectance of CD-RWs is lower than for regular CDs.

*For MP3 discs

- This unit manages files and folders on MP3 discs as “tracks” and “albums.”
- Playback order of the MP3 files (tracks) recorded on a disc are determined by the writing (or encoding) application; therefore, playback order may be different from the one you have intended while recording the files and the folders.
- This unit show the file name—Available characters: 0–9, A–Z, _ (underscore)—on the display when the file (tracks) starts play; however some file names are not shown correctly.



More about MP3 discs

- MP3 discs (either CD-R or CD-RW) require a longer readout time. (It varies due to the complexity of the recording configuration.)
- When making an MP3 disc, select ISO 9660 Level 1 or Level 2 as the disc format.
- This unit does not support multisession recording.
- This unit can play MP3 files only with the following file extensions—“.MP3,” “.Mp3,” “.mp3,” and “.mp3.”
- Non-MP3 files are ignored. If non-MP3 files are recorded together with MP3 files, this unit will take a longer time to scan the disc. It may also cause the unit to malfunction.
- Some MP3 discs may not be played back because of their disc characteristics or recording conditions.

Loading CDs

1 Press .

The unit automatically turns on and the carrousel comes out.



2 Place one or two discs correctly on the front recesses of the disc tray, with its label side up.

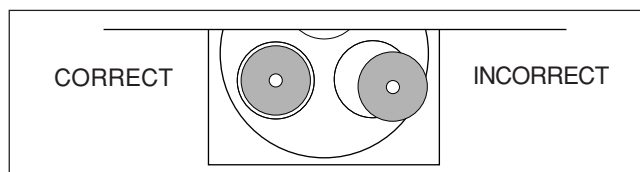

- When using a CD single (8 cm), place it on the inner recess of the disc tray.

3 If you wish to load a third disc, press **DISC CHANGE** on the unit or **DISC SKIP** on the remote control.

The disc tray rotates by 120°.

DISC CHANGE



DISC SKIP



4 Press again.

The carrousel closes.



Playing Back CDs—All Disc and One Disc

You can play all loaded CDs continuously—All Disc play, or one selected disc—One Disc play.

All Disc play

On the unit ONLY:

1 Load CDs.

- If the current playing source is not the CD player, press CD ►/II, then  before going to the next step.

2 Press **REPEAT** repeatedly so that the **ALL DISC** indicator lights up on the display.



For Audio CD:

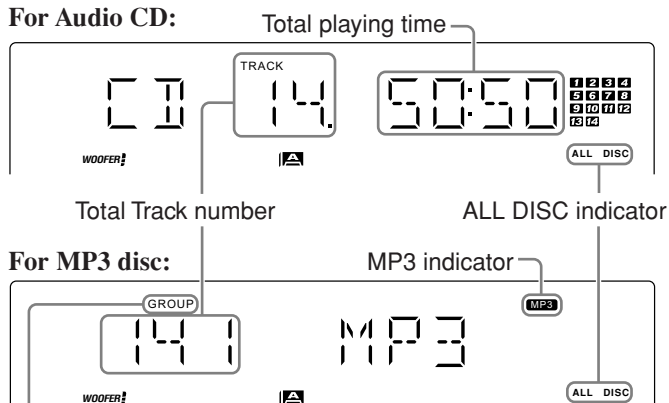

For MP3 disc:

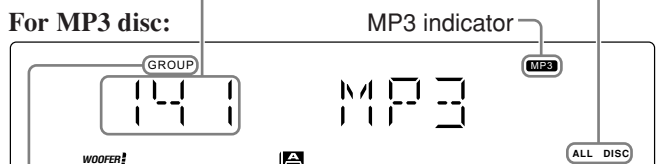

GROUP indicator appears when the MP3 playback mode is the ALBUM mode. See also page 17.

- Each time you press the button, the indication on the display changes as follows:



* See page 19.

3 Press one of the disc number buttons (CD1, CD2 or CD3) for the disc you want to start to play from.

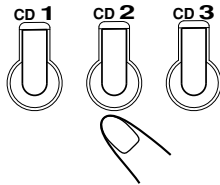

CD play starts from the first track of the selected disc.

- Pressing CD ►/|| instead of the disc number buttons starts playing back if a CD is on the tray.

For Audio CD:

Track number of the currently playing disc flashes (Track numbers exceeding 16 are not displayed.)

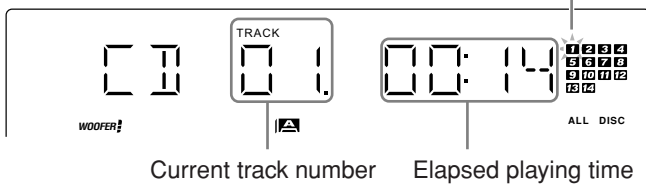

For MP3 disc:

- When the MP3 playback mode is the ALBUM mode (See also page 17.)

Current album number



Current track title scrolls.

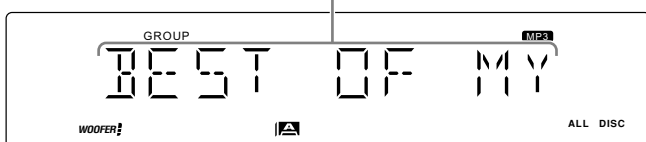

Current track number of the current album Elapsed playing time

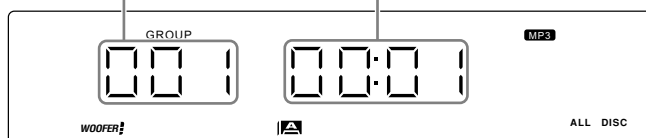

- When the MP3 playback mode is the TRACK mode (See also page 17.)

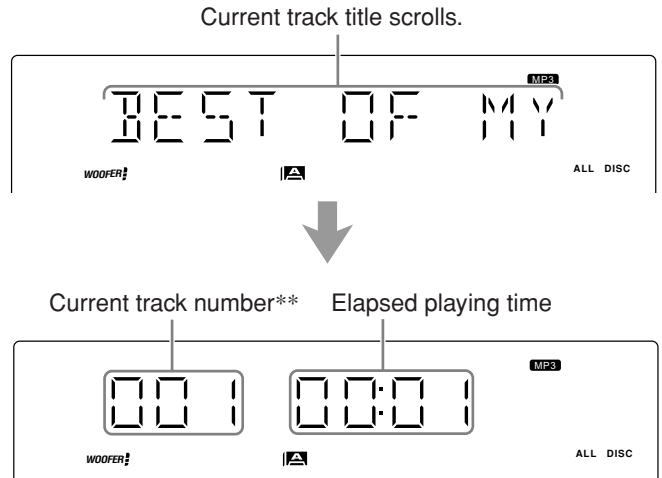

** In the TRACK mode, the unit manage only files (tracks) on the MP3 disc. Folders (albums) are not recognized.

To stop during play, press ■.

- For MP3 disc, this unit can store the number of the track that you have stopped playback. By pressing CD ►/||, you can start playback again from the beginning of the same track—Resume play (see also page 17).

To remove the disc, press ▲.



CD playback sequence

When 3 CDs are loaded on the disc trays, they are played in one of the following sequences.

- When CD1 is pressed : CD1 ⇒ CD2 ⇒ CD3 (then stops)
- When CD2 is pressed : CD2 ⇒ CD3 ⇒ CD1 (then stops)
- When CD3 is pressed : CD3 ⇒ CD1 ⇒ CD2 (then stops)

* When only 2 CDs are loaded, they are played in the same order, but the disc tray without a CD is skipped.



About the disc number lamps (CD1, CD2, and CD3)

- Each disc number lamp corresponds to the disc tray of the same number.
- The disc number lamp flashes while the corresponding CD is being played.
- The disc number lamp goes off when the unit has detected that there is no CD on the corresponding disc tray.

One Disc play

When 2 or 3 CDs are loaded on the disc trays, you can select one particular disc to be played back.

On the unit ONLY:

1 Load CDs.

- If the current playing source is not the CD player, press CD ►/||, then ■ before going to the next step.

2 Press REPEAT repeatedly so that the 1 DISC indicator lights up on the display.



- Each time you press the button, the indication on the display changes as follows:

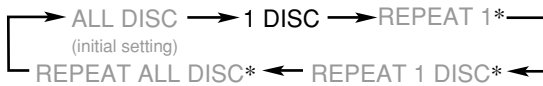

* See page 19.

3 Press one of the disc number buttons (CD1, CD2 or CD3) you want to listen.

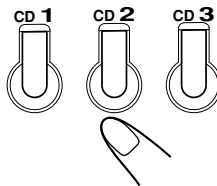

Playback stops when all tracks of the selected disc are played once and resumes to All Disc play.

To stop during play, press ■.

- For MP3 disc, this unit can store the number of the track that you have stopped playback. By pressing CD ►/||, you can start playback again from the beginning of the same track—Resume play (see also page 17).

To remove the disc, press ▲.

To exit from One Disc play, press REPEAT repeatedly so that ALL DISC indicator lights up on the display.



The following operations will also cancel the One Disc play and restore All Disc play when—

- Turning off the power,
- Ejecting the carousel, or
- Changing the source to play.

Basic CD Operations

While playing a CD, you can do the following operations.

To exchange CDs during playback of another

Press DISC CHANGE to change the CD and the carousel comes out.

DISC CHANGE

If you change CDs during play, the current play will not stop until all CDs you have changed are played.



To close the carousel, press DISC CHANGE or ▲.

To skip to the another CD in the carousel

Press DISC SKIP on the remote control.

DISC SKIP



To stop play for a moment

Press CD ►/||.

While pausing, "PAUSE" appears on the display.



To resume play, press CD ►/|| again.

To locate a particular point in a track

During play, press and hold ◀◀ or ▶▶.

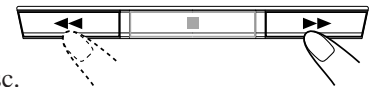

- ◀◀: Fast reverses the disc.
- ▶▶: Fast forwards the disc.

When using the remote control, press and hold ◀◀/◀◀ or ▶▶/▶▶.



To go to another track

For Audio CD:

Turn the ◀◀/▶▶ control before or during playback.



- ◀◀: Goes back to the beginning of the current or previous tracks.
- ▶▶: Skips to the beginning of the next or succeeding tracks.

When using the remote control, press ◀◀/◀◀ or ▶▶/▶▶.





If you turn the ◀◀/▶▶ control (or press ◀◀/◀◀ or ▶▶/▶▶ on the remote control) to select a track while playback is stopped





The selected track starts playback.

For MP3 disc:**When the MP3 playback mode is the TRACK mode**

(See also page 17.)

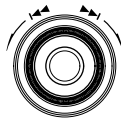
Turn the  control before or during playback.

- : Goes back to the beginning of the current or previous tracks.
- : Skips to the beginning of the next or succeeding tracks.

When using the remote control, press /  or / .



 **If you turn the  control (or press /  or /  on the remote control) to select a track while playback is stopped**





The selected track starts playback.





To go to another album on an MP3 disc**When the MP3 playback mode is the ALBUM mode**

(See also page 17.)

Turn the  control before or during playback.

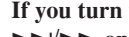
- : Goes back to the beginning of the first track in the previous albums.
- : Skips to the beginning of the first track in the next or succeeding albums.

When using the remote control, press /  or / .

 **If you turn the  control (or press /  or /  on the remote control) to select an album while playback is stopped**

The first track in the selected album starts playback.

To go to another track directly using the number buttons**For Audio CD:**

Pressing the number button(s) before or during play allows you to start playing the selected track.

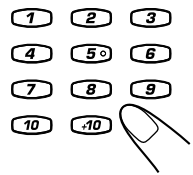

Ex.: For track number 5, press 5.

For track number 15, press +10, then 5.

For track number 20, press +10, then 10.

For track number 32, press +10, +10, +10, then 2.

For MP3 disc:**• When the MP3 playback mode is the TRACK mode**

(See also page 17.)

Pressing the number button(s) before or during play allows you to start playing the selected track on the disc.

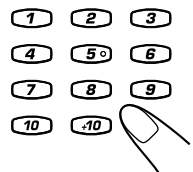

Ex.: For track number 5, press 5.

For track number 15, press +10, then 5.

For track number 20, press +10, then 10.

For track number 32, press +10, +10, +10, then 2.

For track number 123, press +10 twelve times, then 3.

• When the MP3 playback mode is the ALBUM mode

(See also page 17.)

Pressing the number button(s) before or during play allows you to start playing the selected track in the current album.

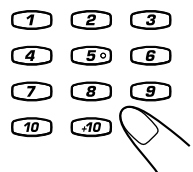

Ex.: For track number 5, press 5.

For track number 15, press +10, then 5.

For track number 20, press +10, then 10.

For track number 32, press +10, +10, +10, then 2.

For track number 123, press +10 twelve times, then 3.

**If your entry is ignored**

You have tried to enter a track number that does not exist on the disc or in the album (for example, selecting track 14 in the album that only has 12 tracks). Such entries are ignored.

Changing the MP3 Playback Mode

When playing an MP3 disc, you can choose the playback mode of the MP3 disc as follows:

- **TRACK mode:**
The unit recognizes only tracks (files). You can play an MP3 disc like an Audio CD.
- **ALBUM mode:**
The unit recognizes tracks (files) and albums (folders) on an MP3 disc. You can play an MP3 disc according to the way how they are grouped.
In this mode, you can do the following operations:
 - Turning the **|◀◀/▶▶|** control (or pressing **|◀◀/▶▶** or **▶▶/▶▶** on the remote control) allows you to skip to the first track of the previous or next albums. (See page16.)
 - Pressing the number button(s) allows you to start playing the selected track in the current album. (See page16.)

On the remote control ONLY:

Press **MP3** before or during playing an MP3 disc.



GROUP indicator appears when the MP3 playback mode is the ALBUM mode.

- Each time you press the button, the MP3 playback mode changes between “ALBUM” and “TRACK” alternately.

Turning On or Off the Resume Play for MP3 Disc

For MP3 disc, this unit can store the number of the track that you have stopped playback. By pressing **CD ▶/||**, you can start playback again from the beginning of the same track—Resume play.

You can turning on and off the resume play for MP3 discs.

On the unit ONLY:

Press **PROGRAM** before or during playing an MP3 disc.



- Each time you press **PROGRAM**, the resume play turns on and off alternately.



notes The following operations will erase the memory of the track number that you have stopped playback when—

- Pressing **▲** to eject the disc.
- Pressing one of the disc number buttons to change the disc to play.

Programming the Playing Order of the Tracks —Program Play

You can arrange the order in which the tracks play before you start playing. **You can program up to 32 tracks.**

- To use Repeat play (see page 19) for Program play, press REPEAT after starting Program play.
- This function does not work for MP3 discs.

On the unit ONLY:

1 Load CDs.

- If the current playing source is not the CD player, press CD ►/||, then ■ before going to the next step.

2 Press PROGRAM so that “PROGRAM” appears on the display.

The PRGM (program) indicator also lights up on the display.

- All Disc play is selected automatically. You cannot select One Disc play for Program play.



- If a program has been stored in memory, the program is called up.

3 Press one of the disc number buttons (CD1, CD2, and CD3) to select the disc number you want to play.

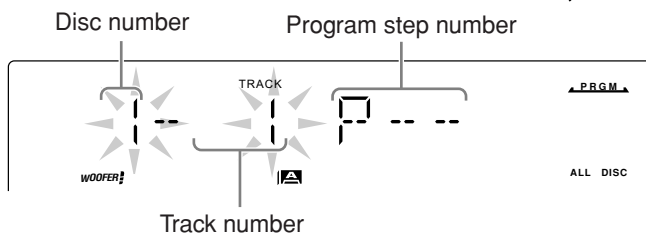
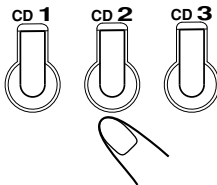

4 Turn the ◀◀/▶▶ control to select the track number, then press SET.

Each time you select a track and press SET, the selected track number is added to the track number indicator.

- You can select up to the 99th track on each disc.

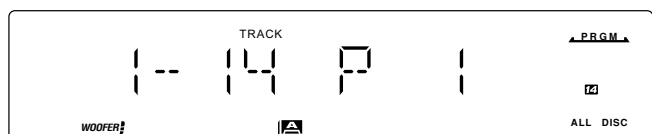
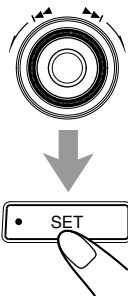

5 Program other tracks you want.

- To program tracks from the same disc, repeat step 4.
- To program tracks from a different disc, repeat steps 3 and 4.

6 Press CD ►/||.

The tracks are played in the order you have programmed.



To stop during play, press ■.

To exit from Program play, press PROGRAM again before or after play so that the unit enters All Disc play. (The program you have made is stored in memory until you turn off the unit, eject the carousel, or erase the program.)

- Program play is also canceled when you press ▲.

To modify the program

Before playing, you can erase the last programmed track shown on the display by pressing CANCEL/DEMO.

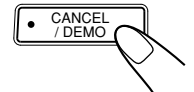

- Each time you press the button, the last programmed track is erased from the program.

To check the program during play, perform the following procedure:

- You can check only the programmed tracks on the current disc at one time.

1 Press CD ►/|| to pause Program play.

2 Turn the ◀◀/▶▶ control.

The programmed tracks on the currently selected disc appear on the display in the programmed (or reverse) order.

- If tracks on another disc have been programmed, “PAUSE” appears on the display.

To check the programmed tracks on another disc, press CD ►/|| twice, then turn the ◀◀/▶▶ control.

- Pressing CD ►/|| again starts Program play from the track currently shown on the display.

To add tracks in the program before play, simply select the disc numbers and/or track numbers you want to add by following steps 3 and 4 of the programming procedure.

To erase the entire program before or during play, press ■ twice.

- Turning the power off or ejecting the carousel will also erase the stored memory.



If you try to program a 33rd track “FULL” will appear on the display.



If you have programmed a track from an empty tray, or a track number that does not exist on the disc Such program steps will be skipped.



If there is an MP3 disc on the disc tray Even if you add tracks on the MP3 disc to the program in step 3 to 5, those tracks will be skipped.



Playing at Random—Random Play

The tracks of the selected CD will play at random.

- To use Random play, you have to cancel the Program play.

On the unit ONLY:

1 Load a CD.

2 Press one of the disc number buttons (CD1, CD2, and CD3) for the disc you want to play, then press ■.

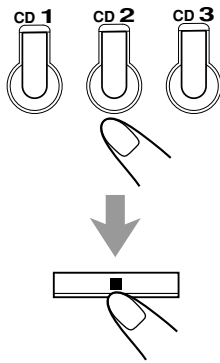

3 Press RANDOM so that “RANDOM” appears on the display.

The RANDOM indicator also lights up on the display.

- Activating Random play cancels Repeat play or All Disc play. (One Disc play is automatically selected.)
- For MP3 discs, activating Random play changes the ALBUM mode to the TRACK mode.



- The tracks are played automatically at random. Random play ends when all tracks are played once.

To stop and cancel Random play, press ■.

- If you press RANDOM again during play, Random play is canceled and the unit enters All Disc play mode.
- Random play is also canceled when you press ▲.



If you turn the ◀▶ control (or press ◀▶/◀◀ or ▶▶/▶▶ on the remote control)

Playback skips to the next track selected randomly.

Repeating Tracks or CDs—Repeat Play

You can have all the CDs, the program or the individual track currently playing repeat as many times as you like.

- Repeat play and Random play cannot be used at the same time.

On the unit ONLY:

To repeat play, press REPEAT during or before playing.



- Each time you press the button, Repeat play mode changes as follows, and the following indicator lights up on the display:

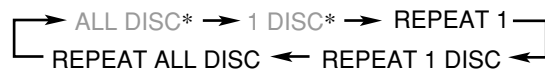

- REPEAT 1:** Repeats one track on one CD.
- REPEAT 1 DISC**:** Repeats all the tracks on one CD.
- REPEAT ALL DISC:** Repeats all the tracks on all the CDs, or all the tracks on the program.

* See pages 13 and 15.

** REPEAT 1 DISC is not used for Program play.

To cancel Repeat play, press REPEAT repeatedly until the REPEAT indicator (REPEAT 1, REPEAT 1 DISC or REPEAT ALL DISC) goes off from the display.

- Repeat play is also canceled when you press ■ or ▲.

Prohibiting Disc Ejection—Carrousel Lock

You can prohibit CD ejection from the unit and can lock the carrousel.

- This operation is possible only while the unit is on with CD selected as the source.

On the unit ONLY:

To prohibit disc ejection, press ▲ for the carrousel while holding ■.

“LOCKED” appears for a while, and the carrousel is locked.



If you try to eject CDs

“LOCKED” appears to inform you that the Carrousel Lock is in use.

To cancel the prohibition and unlock the carrousel, press ▲ for the carrousel while holding ■.

“UN LOCKED” appears for a while, and the carrousel is unlocked.



When you unplug the AC power cord or if a power failure occurs

The setting of the Carrousel Lock will return to the initial setting (not to prohibit disc ejection) in a few days.

Playing Back Tapes



Playing Back a Tape

1 Press **EJECT** for the deck you want to use.

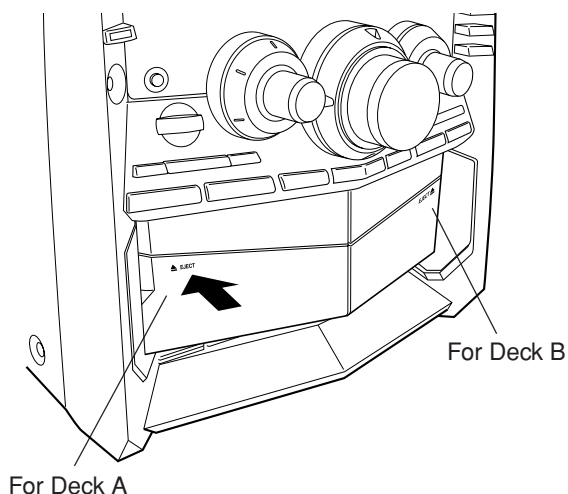

2 Put a cassette in, with the exposed part of the tape down and the side you want to play facing front.

- You can play back only type I tapes.

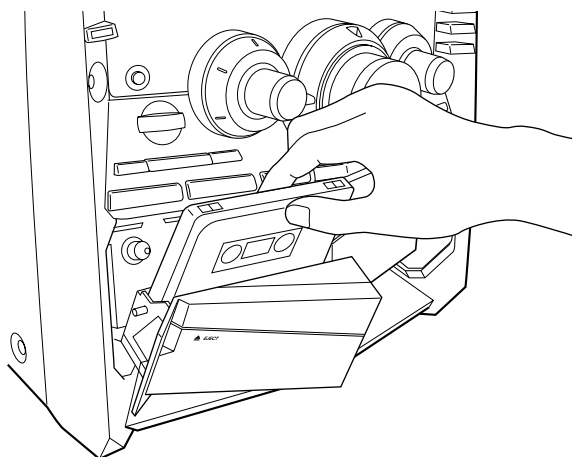

3 Close the cassette holder gently.

If you put cassettes in both decks A and B, the last deck which you have put a cassette into is selected.

To operate the other deck, press TAPE A/B (or A/B on the remote control).

4 Press **TAPE**.

The tape play starts and the tape running indicator (▶) starts flashing slowly.

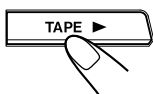

When the tape plays to the end, the deck automatically stops.

To stop during play, press ■.

To operate the other deck, press TAPE A/B (or A/B on the remote control), then TAPE ▶.

To fast-forward the tape, press ▶▶ (or ▶▶/▶▶ on the remote control). The tape running indicator (▶) starts flashing quickly.

To rewind the tape, press ◀◀ (or ◀◀/◀◀ on the remote control). The tape running indicator (◀) starts flashing quickly.

To remove the cassette, press **EJECT** for deck A or **EJECT** for deck B.

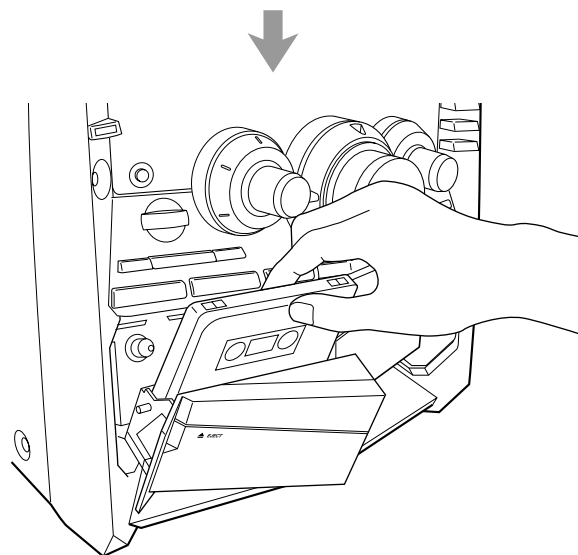
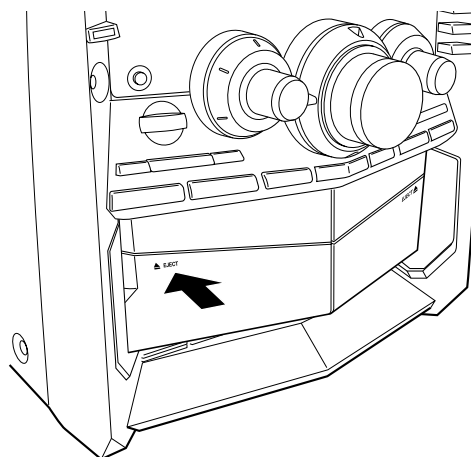

The use of the C-120 or thinner tape is not recommended, since characteristic deterioration may occur and this tape easily jams in the pinch-rollers and the capstans.

Recording

IMPORTANT:

- It should be noted that it may be unlawful to re-record pre-recorded tapes, records, or discs without the consent of the owner of copyright in the sound or video recording, broadcast or cable program and in any literary, dramatic, musical, or artistic embodied therein.
- The recording level is automatically set correctly, so it is not affected by the VOLUME, the SUBWOOFER LEVEL, and the SOUND MODE controls. Thus, during recording you can adjust the sound you are actually listening to without affecting the recording level.
- While recording, you can hear the SOUND TURBO effect through the speakers or headphones. However, the sound is recorded without this effect (see page 10).
- If recordings you have made have excessive noise or static, the unit may be too close to a TV. Place the unit away from the TV.
- You can use type I tape for recording.

To protect your recording

Cassettes have two small tabs on the back to protect unexpected erasure or re-recording.

To protect your recording, remove these tabs.

To re-record on a protected tape, cover the holes with adhesive tape.

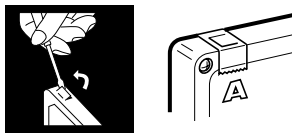

To keep the best recording and playback sound quality

If the heads, capstans, and pinch rollers of the cassette decks become dirty, the following will occur:

- Impaired sound quality
- Discontinuous sound
- Fading
- Incomplete erasure
- Difficulty in recording

To clean the head, capstan, and pinch roller

Use a cotton swab moistened with alcohol.

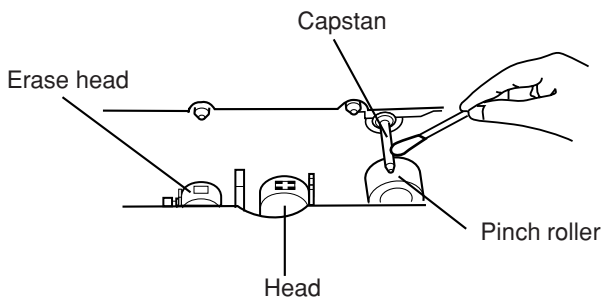

To demagnetize the head

Turn off the unit, and use a head demagnetizer (available at electronics and audio shops).

Recording a Tape on Deck B

On the unit ONLY:

1 Press EJECT ▲ for deck B.

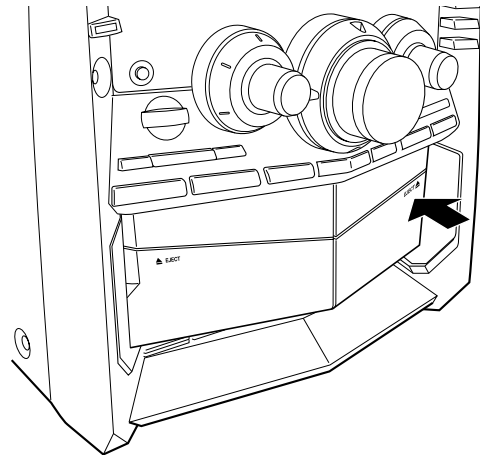

2 Put a recordable cassette in, with the exposed part of the tape down and the side you want to record facing front.

3 Close the cassette holder gently.

4 Start playing the source—FM, AM, CD player or auxiliary equipment connected to AUX IN jacks.

- For duplicating tapes, see “Dubbing Tapes” on page 22.
- For recording from CD, see “CD Synchronized Recording” on page 22.

5 Press REC START/STOP.

The REC (recording) indicator lights up on the display and recording starts.



To stop during recording, press REC START/STOP again or ■.

To remove the cassette, press EJECT ▲ for deck B.

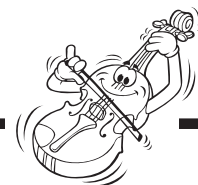

Dubbing Tapes

On the unit ONLY:

1 Press TAPE ►, then ■.

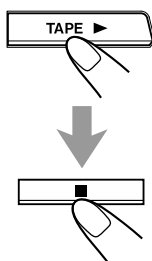

2 Put the source cassette in deck A, and a recordable cassette into deck B.

3 Press DUBBING.

Dubbing starts.
“DUBBING” appears, and the REC (recording) indicator lights up on the display.



To stop during dubbing, press REC START/STOP or ■.

To remove the cassettes, press ▲ EJECT for deck A and EJECT ▲ for deck B.

CD Synchronized Recording

You can easily record a CD onto a tape.

- This function does not work for MP3 discs. When recording an MP3 disc onto a tape, see “Recording a Tape on Deck B” on page 21.
- You can also record the tracks in the order you have made the program.
If there is a track on the MP3 disc in the program, it will be skipped and some blank space will be recorded on the tape.

On the unit ONLY:

1 Put a recordable cassette into deck B.

2 Place a disc correctly on the recess of the disc tray, with its label side up.

3 Press one of the disc number buttons (CD1, CD2, and CD3) to select the disc, then ■.

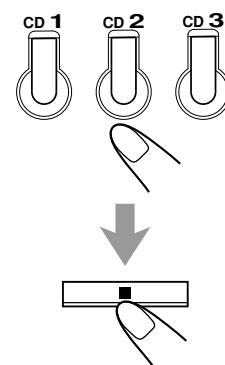

4 Press CD REC START.

“CD REC” appears, and the REC (recording) indicator lights up on the display.



Deck B starts recording and the CD player starts playing. When the recording from the selected CD is done, the CD player and deck B stop.

- When recording your program, the CD player and deck B stop after all tracks in the program are recorded.

To stop during CD Synchronized Recording, press REC START/STOP or ■.

To remove the cassette, press EJECT ▲ for deck B.

Using the Timers

There are three timers available—Daily Timer, Recording Timer, and Sleep Timer. Before using the timers, you need to set the clock built in the unit. (See “Setting the Clock” on page 9.)

Using Daily Timer

With Daily Timer, you can wake to your favorite music or radio program. You can set the timer whether the unit is on or off.

How Daily Timer actually works

The unit automatically turns on, set the volume level to the preset level, and starts playing the specified source when the on-time comes (the  indicator flashes while the timer is operating). Then, when the off-time comes, the unit automatically turns off (stands by).

Daily Timer works every day unless you cancel it.

- There is a time limit in doing the following steps. If the setting is canceled before you finish, start from step 1 again.
- If you have made a mistake while setting timer, press CANCEL/DEMO. (However, this does not always work. If CANCEL/DEMO does not work, press CLOCK/TIMER repeatedly and start from step 1 again.)

Before you start...

- When using a CD as the source to play:
 - Make sure there is a CD on the currently selected disc number tray.
- When using a tape as the source to play:
 - Make sure that a tape is in the deck whose deck indicator (A or B) is lit on the display.
- When using the external component as the source to play:
 - Set the timer equipped with the external component at the same time.

On the unit ONLY:

1 Press CLOCK/TIMER repeatedly until “DAILY” appears on the display.

 indicator lights up and the DAILY (daily timer) indicator starts flashing on the display.

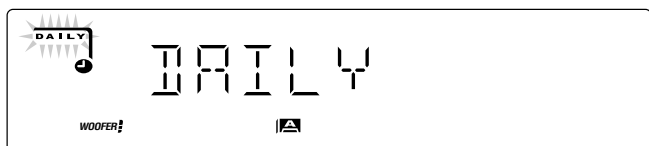

- Each time you press the button, the clock/timer setting modes change as follows:

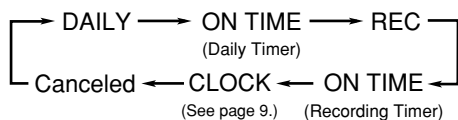



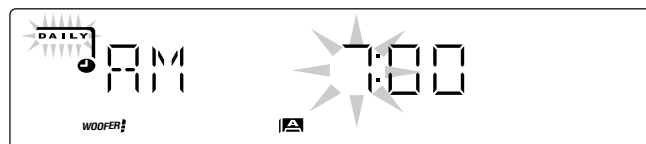
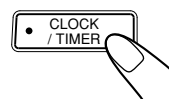

2 Press CLOCK/TIMER again.

“ON TIME” appears for 2 seconds, then the unit enters on-time setting mode.





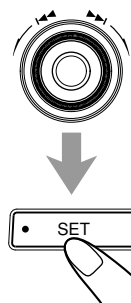

3 Set the on-time you want the unit to turn on.

- 1) Turn the   control to set the hour, then press SET.
 - 2) Turn the   control to set the minute, then press SET.
- “OFF TIME” appears for 2 seconds, then the unit enters off-time setting mode.



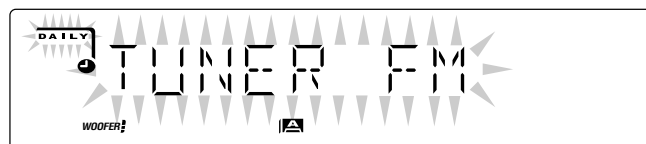
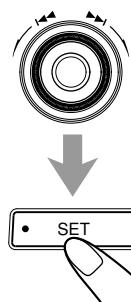

4 Set the off-time you want the unit to turn off (on standby).

- 1) Turn the   control to set the hour, then press SET.
 - 2) Turn the   control to set the minute, then press SET.
- The unit enters source selecting mode.



5 Turn the control to select the source to play, then press SET.

- Each time you turn the   control, the source changes as follows:

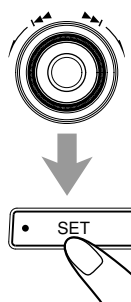

- TUNER FM : tunes in to a specified preset FM station.
 - go to step 6.
- TUNER AM : tunes in to a specified preset AM station.
 - go to step 6.
- CD : plays the current disc from the first track.
 - go to step 7.
- TAPE : plays a tape in deck A or B.
 - go to step 7.
- AUX : plays an external source.
 - go to step 7.

6 Select the preset station number.

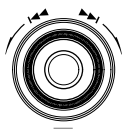
Turn the  control to select the preset station number, then press SET. The unit enters volume setting mode.



7 Turn the control to set the volume level.

You can select the volume level from VOL MIN, VOL 1 — VOL 30, and VOL MAX.

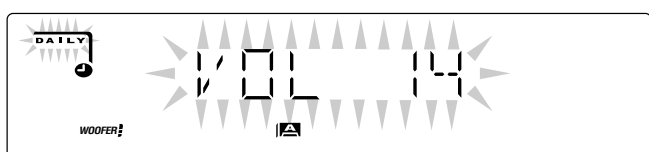

8 Press SET to complete the Daily Timer setting.

The DAILY (daily timer) indicator stops flashing and remains lit. The settings you have done are shown on the display in sequence for your confirmation.

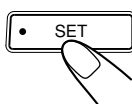

9 Press STANDBY/ON to turn off the unit (on standby) if you have set the Daily Timer with the unit turned on.

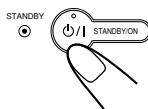

If the unit is turned on when the timer-on time comes Daily Timer does not work.

To turn on or off Daily Timer after its setting is done

1 Press CLOCK/TIMER repeatedly until "DAILY" appears on the display.



2 To turn off the Daily Timer, press CANCEL/DEMO.

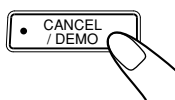

The DAILY (daily timer) indicator goes off from the display ("OFF" appears for a while).

The Daily Timer is canceled, but the setting for the Daily Timer remains in memory until you change it.

To turn on the Daily Timer, press SET. The DAILY (daily timer) indicator lights up on the display. The settings you have done are shown on the display in sequence for your confirmation.

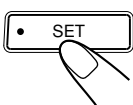

Using Recording Timer

With Recording Timer, you can make a tape of a radio broadcast automatically. You can set the timer whether the unit is on or off.

How Recording Timer actually works

The unit automatically turns on, tunes in to the specified station, sets the volume level to "VOL MIN," and starts recording when the on-time comes (the  indicator flashes while the timer is operating). Then, when the off-time comes, the unit automatically turns off (stands by).

Recording Timer works only once, but the timer setting remains in memory until you change it.

- There is a time limit in doing the following steps. If the setting is canceled before you finish, start from step 2 again.
- If you have made a mistake while setting the timer, press CANCEL/DEMO. (However, this does not always work. If CANCEL/DEMO does not work, press CLOCK/TIMER repeatedly and start from step 2 again.)

On the unit ONLY:

1 Put a recordable cassette into deck B.

2 Press CLOCK/TIMER repeatedly until "REC" appears on the display.

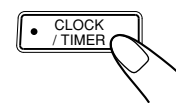

 indicator lights up and the REC (recording timer) indicator starts flashing on the display.



- Each time you press the button, the clock/timer setting modes change as follows:



3 Press CLOCK/TIMER again.

"ON TIME" appears for 2 seconds, then the unit enters on-time setting mode.

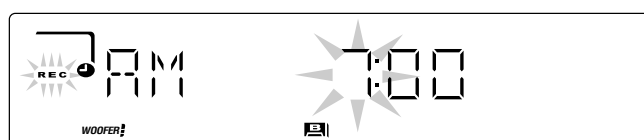
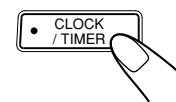



4 Set the on-time you want the unit to turn on.

- 1) Turn the ◀◀/▶▶ control to set the hour, then press SET.
- 2) Turn the ◀◀/▶▶ control to set the minute, then press SET.
“OFF TIME” appears for 2 seconds, then the unit enters off-time setting mode.

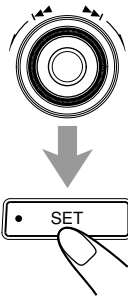

5 Set the off-time you want the unit to turn off (on standby).

- 1) Turn the ◀◀/▶▶ control to set the hour, then press SET.
- 2) Turn the ◀◀/▶▶ control to set the minute, then press SET.
The unit enters preset station selecting mode.



6 Select the preset station.

- 1) Turn the ◀◀/▶▶ control to select the band (“TUNER FM” or “TUNER AM”), then press SET.
- 2) Turn the ◀◀/▶▶ control to select a preset channel number, then press SET.
The REC (recording timer) indicator stops flashing and remains lit. The settings you have done are shown on the display in sequence for your confirmation.

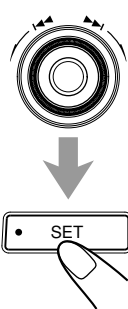

7 Press ⏻/STANDBY/ON to turn off the unit (on standby) if necessary.

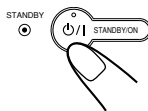

About the recording source

If you change the source while recording, the recording source also changes.

To turn on or off Recording Timer after its setting is done

1 Press CLOCK/TIMER repeatedly until “REC” appears on the display.



2 To turn off the Recording Timer, press CANCEL/DEMO.



The REC (recording timer) indicator goes off from the display (“OFF” appears for a while). The Recording Timer is canceled, but the setting for the Recording Timer remains in memory until you change it.

To turn on the Recording Timer, press SET.



The REC (recording timer) indicator lights up on the display. The settings you have done are shown on the display in sequence for your confirmation.

Using Sleep Timer

With Sleep Timer, you can fall asleep to music. You can set Sleep Timer when the unit is turned on.

How Sleep Timer actually works

The unit automatically turns off after the specified time length passes.

On the remote control ONLY:

1 Press SLEEP.

The time length until the shut-off time appears and the SLEEP indicator starts flashing on the display.



- Each time you press the button, the time length changes as follows:

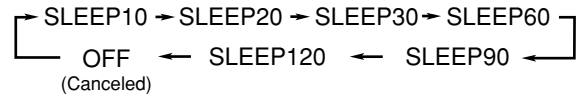

2 Wait for about 3 seconds after specifying the time length.

The SLEEP indicator stops flashing and remains lit.

To check the remaining time until the shut-off time, press SLEEP once so that the remaining time until the shut-off time appears for about 3 seconds.

To change the shut-off time, press SLEEP repeatedly until the desired time length appears on the display.

To cancel the setting, press SLEEP repeatedly until “OFF” appears on the display so that the SLEEP indicator goes off from the display.

- Sleep Timer is also canceled when you turn off the unit.

Timer Priority

Since each timer can be set separately, you may wonder what happens if the setting for these timers overlaps. Here are some examples.

• Recording Timer has priority over Daily Timer.

If Recording Timer is set to come on while Daily Timer is operating, Daily Timer is canceled and Recording Timer start working.

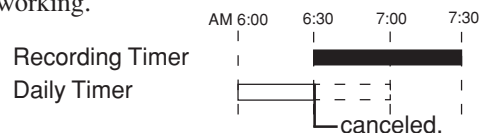

• If Sleep Timer overlaps with another timer (either Daily Timer or Recording Timer), a timer with the earlier shut-off time has priority.

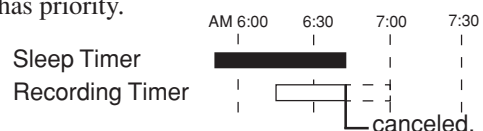

When using the Recording Timer and Sleep Timer at the same time, pay special attention to the shut-off time.

Maintenance



To get the best performance of the unit, keep your discs, tapes, and mechanism clean.

Cleaning the unit

• Stains on the unit

Should be wiped off with a soft cloth. If the unit is heavily stained, wipe it with a cloth soaked in water-diluted neutral detergent and wrung well, then wipe clean with a dry cloth.

• Avoid the following since they may cause damage to the unit.

- DO NOT wipe it with a hard cloth.
- DO NOT wipe it strong.
- DO NOT wipe it with thinner or benzine.
- DO NOT apply any volatile substance such as insecticides to it.
- DO NOT allow any rubber or plastic to remain in contact with it for a long time.

Handling discs

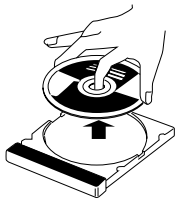

- Remove the disc from its case by holding it at the edge while pressing the center hole lightly.
- Do not touch the shiny surface of the disc, or bend the disc.
- Put the disc back in its case after use to prevent warping.

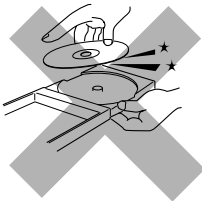

- Be careful not to scratch the surface of the disc when placing it back in its case.
- Avoid exposure to direct sunlight, temperature extremes, and moisture.

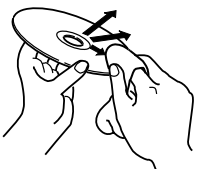

To clean the disc

Wipe the disc with a soft cloth in a straight line from center to edge.



DO NOT use any solvent—such as conventional record cleaner, spray, thinner, or benzine—to clean the disc.

Handling cassette tapes

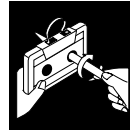

- If the tape is loose in its cassette, take up the slack by inserting a pencil in one of the reels and rotating.
- If the tape is loose, it may get stretched, cut, or caught in the cassette.

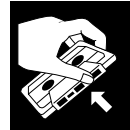

- Be careful not to touch the tape surface.



- Avoid the following places to store the tape:

- In dusty places
- In direct sunlight or heat
- In moist areas
- Near a magnet

Troubleshooting



If you are having a problem with your unit, check this list for a possible solution before calling for service.

If you cannot solve the problem from the hints given here, or the unit has been physically damaged, call a qualified person, such as your dealer, for service.

Symptom	Cause	Action
Unable to cancel the display demonstration.	Other buttons are pressed to cancel the display demonstration.	Press CANCEL/DEMO on the unit. (See page 8.)
No sound is heard.	Connections are incorrect or loose.	Check all connections and make corrections. (See pages 6 to 8.)
Hard to listen to broadcasts because of noise.	<ul style="list-style-type: none"> Antennas are disconnected. The AM loop antenna is too close to the unit. The FM antenna is not properly extended and positioned. 	<ul style="list-style-type: none"> Reconnect the antennas correctly and securely. Change the position and direction of the AM loop antenna. Extend the FM antenna at the best position.
The disc sound is discontinuous.	The disc is scratched or dirty.	Clean or replace the disc. (See page 26.)
The carrousel does not open or close.	<ul style="list-style-type: none"> The AC power cord is not plugged in. The carrousel is locked. 	<ul style="list-style-type: none"> Plug the AC power cord. Unlock the carrousel. (See page 19.)
The disc does not play.	The disc is placed upside down.	Place the disc with the label side up.
The MP3 disc does not play.	<ul style="list-style-type: none"> No MP3 files are recorded on the disc. MP3 files do not have the file extension—.MP3, .Mp3, .mP3, or .mp3 in their file names. MP3 files are not recorded in the format compliant with ISO 9660 Level 1 or Level 2. 	Replace the disc.
The readout time of the MP3 disc is too long.	The readout time varies with the complexity of the recording configuration.	Do not use too many hierarchies and folders when recording. Also, do not record any other types of audio tracks together with MP3 files. (See page 13.)
The cassette holders cannot be opened.	Power supply from the AC power cord has been cut off while the tape was running.	Turn on the unit.
Impossible to record.	Small tabs on the back of the cassette are removed.	Cover the holes with adhesive tape.
Operations are disabled.	The built-in microprocessor may malfunction due to external electrical interference.	Unplug the AC power cord and then plug it back in.
Unable to operate the unit from the remote control.	<ul style="list-style-type: none"> The path between the remote control and the remote sensor on the unit is blocked. The batteries are exhausted. 	<ul style="list-style-type: none"> Remove the obstruction. Replace the batteries.

Specifications

Design and specifications are subject to change without notice.

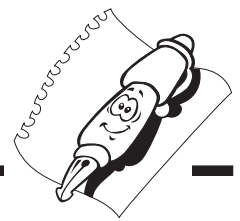

Amplifier section—CA-MXGT88

Output Power

SUBWOOFERS : 160 W per channel, min. RMS, driven into 6 Ω at 63 Hz with no more than 10% total harmonic distortion.

MAIN SPEAKERS: 70 W per channel, min. RMS, driven into 4 Ω at 1 kHz with no more than 10% total harmonic distortion.

Audio input sensitivity/Impedance

(at 1 kHz, measured at MAIN SPEAKERS)

AUX : 400 mV/50 k Ω

Speakers/Impedance : Subwoofers : 6 Ω – 16 Ω
Main speakers : 4 Ω – 8 Ω

Tuner

FM tuning range : 87.50 MHz – 108.00 MHz

AM tuning range: 530 kHz – 1 710 kHz

CD player

CD Capacity : 3 CDs

Dynamic range : 85 dB

Signal-to-noise ratio : 85 dB

Cassette deck

Frequency response

Normal (type I): 50 Hz — 14 000 Hz

Wow and flutter : 0.15% (WRMS)

General

Power requirement : AC 120 V \sim , 60 Hz

Power consumption : 190 W (at operation)
22 W (on standby)

Dimensions (approx.): 270 mm x 317 mm x 453 mm (W/H/D)
(10^{11/16} in. x 12^{1/2} in. x 17^{7/8} in.)

Mass (approx.) : 9.3 kg (20.6 lbs)

Supplied accessories

See page 6.

Speaker section—SP-MXGT88

Type : 3-way bass-reflex type

Speaker units : Subwoofer : 20 cm (7^{7/8} in.)
cone x1

Main Woofer : 12 cm (4^{3/4} in.)
cone x1

Tweeter : 5 cm (2 in.) cone x1

Power handling capacity : Subwoofer : 160 W
Main speaker : 70 W

Impedance : Subwoofer : 6 Ω
Main speaker : 4 Ω

Frequency range : Subwoofer : 30 Hz — 70 Hz
Main speaker : 70 Hz — 20 000 Hz

Sound pressure level : Subwoofer : 77 dB/W•m
Main speaker : 84 dB/W•m

Dimensions (approx.) : 220 mm x 453 mm x 332 mm (W/H/D)
(8^{11/16} in. x 17^{7/8} in. x 13^{1/8} in.)

Mass (approx.) : 5.7 kg (12.6 lbs) each

Amplifier section—CA-MXGA77

Output Power

SUBWOOFERS : 120 W per channel, min. RMS, driven into 6 Ω at 63 Hz with no more than 10% total harmonic distortion.

MAIN SPEAKERS: 60 W per channel, min. RMS, driven into 4 Ω at 1 kHz with no more than 10% total harmonic distortion.

Audio input sensitivity/Impedance

(at 1 kHz, measured at MAIN SPEAKERS)

AUX : 400 mV/50 k Ω

Speakers/Impedance : Subwoofers : 6 Ω – 16 Ω
Main speakers : 4 Ω – 8 Ω

Tuner

FM tuning range : 87.50 MHz – 108.00 MHz

AM tuning range: 530 kHz – 1 710 kHz

CD player

CD Capacity : 3 CDs

Dynamic range : 85 dB

Signal-to-noise ratio : 85 dB

Cassette deck

Frequency response

Normal (type I): 50 Hz — 14 000 Hz

Wow and flutter : 0.15% (WRMS)

General

Power requirement : AC 120 V \sim , 60 Hz

Power consumption : 160 W (at operation)
18 W (on standby)

Dimensions (approx.): 270 mm x 317 mm x 453 mm (W/H/D)
(10^{11/16} in. x 12^{1/2} in. x 17^{7/8} in.)

Mass (approx.) : 8.8 kg (19.5 lbs)

Supplied accessories

See page 6.

Speaker section—SP-MXGA77

Type : 3-way bass-reflex type

Speaker units : Subwoofer : 13.5 cm (5^{3/8} in.)
cone x1

Main Woofer : 16 cm (6^{5/16} in.)
cone x1

Tweeter : 5 cm (2 in.) cone x1

Power handling capacity : Subwoofer : 120 W
Main speaker : 60 W

Impedance : Subwoofer : 6 Ω
Main speaker: 4 Ω

Frequency range : Subwoofer : 30 Hz — 70 Hz
Main speaker : 70 Hz — 20 000 Hz

Sound pressure level : Subwoofer : 73 dB/W•m
Main speaker : 86 dB/W•m

Dimensions (approx.) : 290 mm x 317 mm x 336 mm (W/H/D)
(11^{7/16} in. x 12^{1/2} in. x 13^{1/4} in.)

Mass (approx.) : 5.5 kg (12.2 lbs) each



LIMITED WARRANTY

AUDIO-1

JVC COMPANY OF AMERICA warrants this product and all parts thereof, except as set forth below ONLY TO THE ORIGINAL PURCHASER AT RETAIL to be FREE FROM DEFECTIVE MATERIALS AND WORKMANSHIP from the date of original retail purchase for the period as shown below. ("The Warranty Period")

PARTS	1 YR	LABOR	1 YR
-------	-------------	-------	-------------

THIS LIMITED WARRANTY IS VALID ONLY IN THE FIFTY (50) UNITED STATES, THE DISTRICT OF COLUMBIA AND IN COMMONWEALTH OF PUERTO RICO.

WHAT WE WILL DO:

If this product is found to be defective, JVC will repair or replace defective parts at no charge to the original owner. Such repair and replacement services shall be rendered by JVC during normal business hours at JVC authorized service centers. Parts used for replacement are warranted only for the remainder of the Warranty Period. All products and parts thereof may be brought to a JVC authorized service center on a carry-in basis except for Television sets having a screen size 25 inches and above which are covered on an in-home basis.

WHAT YOU MUST DO FOR WARRANTY SERVICE:

Return your product to a JVC authorized service center with a copy of your bill of sale. For your nearest JVC authorized service center, please call toll free: (800) 537-5722.

If service is not available locally, box the product carefully, preferably in the original carton, and ship, insured, with a copy of your bill of sale plus a letter of explanation of the problem to the nearest JVC Factory Service Center, the name and location of which will be given to you by the toll-free number.

If you have any questions concerning your JVC Product, please contact our Customer Relations Department.

WHAT IS NOT COVERED:

This limited warranty provided by JVC does not cover:

1. Products which have been subject to abuse, accident, alteration, modification, tampering, negligence, misuse, faulty installation, lack of reasonable care, or if repaired or serviced by anyone other than a service facility authorized by JVC to render such service, or if affixed to any attachment not provided with the products, or if the model number or serial number has been altered, tampered with, defaced or removed;
2. Initial installation and installation and removal for repair;
3. Operational adjustments covered in the Owner's Manual, normal maintenance, video and audio head cleaning;
4. Damage that occurs in shipment, due to act of God, and cosmetic damage;
5. Signal reception problems and failures due to line power surge;
6. Video Pick-up Tubes/CCD Image Sensor, Cartridge, Stylus (Needle) are covered for 90 days from the date of purchase;
7. Accessories
8. Batteries (except that Rechargeable Batteries are covered for 90 days from the date of purchase);

There are no express warranties except as listed above.

THE DURATION OF ANY IMPLIED WARRANTIES, INCLUDING THE IMPLIED WARRANTY OF MERCHANTABILITY, IS LIMITED TO THE DURATION OF THE EXPRESS WARRANTY HEREIN.

JVC SHALL NOT BE LIABLE FOR THE LOSS OF USE OF THE PRODUCT, INCONVENIENCE, LOSS OR ANY OTHER DAMAGES, WHETHER DIRECT, INCIDENTAL OR CONSEQUENTIAL (INCLUDING, WITHOUT LIMITATION, DAMAGE TO TAPES, RECORDS OR DISCS) RESULTING FROM THE USE OF THIS PRODUCT, OR ARISING OUT OF ANY BREACH OF THIS WARRANTY. ALL EXPRESS AND IMPLIED WARRANTIES, INCLUDING THE WARRANTIES OF MERCHANTABILITY AND FITNESS FOR PARTICULAR PURPOSE, ARE LIMITED TO THE WARRANTY PERIOD SET FORTH ABOVE.

Some states do not allow the exclusion of incidental or consequential damages or limitations on how long an implied warranty lasts, so these limitations or exclusions may not apply to you. This warranty gives you specific legal rights and you may also have other rights which vary from state to state.

JVC COMPANY OF AMERICA 1700 Valley Road
 DIVISION OF JVC AMERICAS CORP. Wayne, NJ 07470

REFURBISHED PRODUCTS CARRY A SEPARATE WARRANTY, THIS WARRANTY DOES NOT APPLY. FOR DETAILS OF REFURBISHED PRODUCT WARRANTY, PLEASE REFER TO THE REFURBISHED PRODUCT WARRANTY INFORMATION PACKAGED WITH EACH REFURBISHED PRODUCT.

For customer use:

Enter below the Model No. which is located either on the rear, bottom or side of the cabinet. Retain this information for future reference.

Model No. :	Serial No. :
Purchase data :	Name of dealer :

Authorized Service Centers

QUALITY **JVC**[®] SERVICE

HOW TO LOCATE YOUR JVC SERVICE CENTER

TOLL FREE: 1 (800) 537-5722

<http://www.jvc.com>

Dear Customer,

In order to receive the most satisfaction from your purchase, please read the instruction booklet before operating the unit. In the event that repairs are necessary, please call 1 (800)537-5722 for your nearest authorized servicer or visit our website at **www.JVC.com**

Remember to retain your Bill of Sale for Warranty Service.

Do not service the television yourself

Caution

To prevent electrical shock, do not open the cabinet. There are no user serviceable parts inside. Please refer to qualified service personnel for repairs.

Accessories

To purchase accessories for your JVC product, please call toll free: 1 (800)882-2345 or on the web at **www.JVC.com**

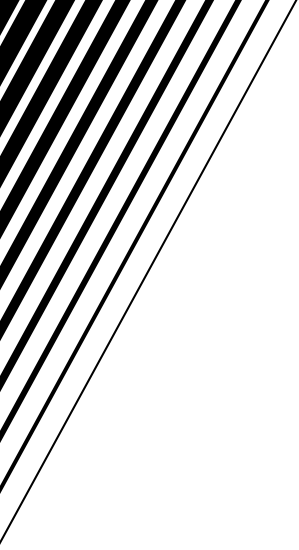

Thank you for purchasing

JVC[®]

Please do not send products or other
correspondence to this address.

307 C



PLACE
FIRST-CLASS
STAMP
HERE

JVC[®]

PRODUCT REGISTRATION DEPARTMENT

PO BOX 13274

DENVER CO 80201-3274



PRODUCT REGISTRATION CARD/QUESTIONNAIRE

US CUSTOMERS ONLY

Registering your product will allow us to contact you in the unlikely event a product safety notification is required.

This is not a warranty card. Retain your bill of sale for proof of warranty coverage.

THANK YOU FOR PURCHASING THIS JVC PRODUCT

REGISTER ONLINE AT: WWW.JVC.COM

IMPORTANT! Please fill-out and return within 10 days!



1 First Name: _____ Initial: _____ Last Name: _____ 307 C
 Address: (Number and Street) _____ Apt #: _____
 City: _____ State: _____ Zip Code: _____

2 Phone #: _____

3 E-mail Address: _____
 If you voluntarily provide us with your email address, you give us permission to share and use your email address to send you email offers that may interest you.
 (EXAMPLE: yourname@yourhost.com)

4 Date of purchase: _____
 Month Day Year

5 Model Number: _____

6 Serial Number: _____

7 Name of store where purchased: _____

8 Purchase Price: \$ _____ .00

9 Did you:
 1. Purchase this product yourself?
 2. Receive this product as a gift?

10 Is this product:
 1. The first product of this type you have ever owned?
 2. A replacement for a similar JVC product?
 3. A replacement for a similar product made by another company?
 4. An addition to a similar product you are still using?

11 What factors most influenced your decision to purchase this product?
 1. JVC brand reputation
 2. Previous experience with JVC products
 3. Price
 4. Specific product features
 5. Style/appearance
 6. Salesperson's recommendation
 7. Friend's/relative's recommendation
 8. Warranty coverage
 9. Other _____

12 A. If you have purchased a mobile audio product, please tell us about the car or truck in which it was installed, otherwise, please tell us about the newest car or truck in your household.

Make: _____
 (e.g. Ford)

Model: _____
 (e.g. Taurus SHO)

Year: _____
B. Please check which applies:
 1. Own
 2. Lease

13 Would you like information on JVC accessories or other JVC products related to the item you purchased?
 1. Yes 2. No

14 Would you be interested in purchasing an extended warranty for your JVC product? 1. Yes 2. No

15 Your gender: 1. Male 2. Female

16 Your marital status: 1. Married 2. Single

17 Date of your birth: _____
 Month Day Year

18 Including yourself, what is the total number of people living in your household?
 (Examples: 01, 02, 03, 04...) _____

19 Date of birth (month/year) of the other adults and children in your household:
 Male Female | Male Female
 1. 2. | 1. 2.
 Month Year | Month Year
 1. 2. | 1. 2.
 Month Year | Month Year

20 For your primary residence, do you:
 1. Own 2. Rent

21 Which best describes your family income?
 1. Under \$15,000 7. \$100,000-\$124,999
 2. \$15,000-\$24,999 8. \$125,000-\$149,999
 3. \$25,000-\$34,999 9. \$150,000-\$174,999
 4. \$35,000-\$49,999 10. \$175,000-\$199,999
 5. \$50,000-\$74,999 11. \$200,000-\$249,999
 6. \$75,000-\$99,999 12. \$250,000 or over

22 Education:
 (Please check which category applies to you):
 1. Some high school 3. College degree
 2. Completed high school 4. Graduate degree

23 In the last six (6) months has anyone in your household purchased any of the following items through the mail and/or over the internet?
 A. Mail B. Internet
 1. Books/magazines
 2. Children's products
 3. Clothes
 4. Insurance/financial products
 5. Music/video/DVD
 6. Travel
 7. Other

24 I use these credit cards:
 1. American Express 4. Visa
 2. Gas/Retail 5. Other _____
 3. Master Card 6. Do not have credit cards

25 Someone in my home participates in the following activities:
 (Check all that apply)
 1. Automotive work 19. Hunting/shooting
 2. Bible/devotional 20. Investments (mutual funds, IRAs)
 3. Boating/sailing 21. Investments (stocks & bonds)
 4. Camping/hiking 22. Movie watching
 5. Casino gambling 23. Own a cat
 6. Contribute to charitable causes 24. Own a dog
 7. Crafts 25. Personal computing / internet
 8. Cultural art/events 26. Photography
 9. Cycling 27. Read books
 10. Do-it-yourself 28. Snow skiing
 11. Enter sweepstakes/contests 29. Self improvement
 12. Fishing 30. Soccer
 13. Fitness/exercise/jogging 31. Tennis
 14. Gardening 32. Travel-Foreign
 15. Golf 33. Travel-U.S.
 16. Gourmet cooking/food/wines 34. TV shopping
 17. Grandchildren 35. Vitamins/natural foods
 18. Home decorating 36. Watch sports on TV

Thank you for completing this questionnaire. Your answers will help us and other companies reach you with offers that may interest you.

If you prefer **not** to receive these offers, please check here [].

BT-51028-2
 (0302)

AH68-00415J

PLEASE FOLD AND SEAL WITH TAPE BEFORE MAILING. DO NOT STAPLE.

Printed in China ▲

Important Products Safety Instruction

Electrical energy can perform many useful functions. But improper use can result in potential electrical shock or fire hazards. This product has been engineered and manufactured to assure your personal safety. In order not to defeat the built-in safeguards, observe the following basic rules for its installation, use and servicing.

ATTENTION:

Follow and obey all warnings and instructions marked on your product and its operating instructions. For your safety, please read all the safety and operating instructions before you operate this product and keep this brochure and the operating instructions packaged with your product for future reference.

INSTALLATION

1. Grounding or Polarization

(A) Your product may be equipped with a polarized alternating-current line plug (a plug having one blade wider than the other). This plug will fit into the power outlet only one way. This is a safety feature.

If you are unable to insert the plug fully into the outlet, try reversing the plug. If the plug should still fail to fit, contact your electrician to replace your obsolete outlet. Do not defeat the safety purpose of the polarized plug.

(B) Your product may be equipped with a 3-wire grounding-type plug, a plug having a third (grounding) pin. This plug will only fit into a grounding-type power outlet. This is a safety feature.

If you are unable to insert the plug into the outlet, contact your electrician to replace your obsolete outlet. Do not defeat the safety purpose of the grounding-type plug.

2. Power Sources

Operate your product only from the type of power source indicated on the marking label. If you are not sure of the type of power supply to your home, consult your product dealer or local power company. If your product is intended to operate from battery power, or other sources, refer to the operating instructions.

3. Overloading

Do not overload wall outlets, extension cords, or integral convenience receptacles as this can result in a risk of fire or electric shock.

4. Power Cord Protection

Power supply cords should be routed so that they are not likely to be walked on or pinched by items placed upon or against them, paying particular attention to cords at plugs, convenience receptacles, and the point where they exit from the product.

5. Ventilation

Slots and openings in the cabinet are provided for ventilation. To ensure reliable operation of the product and to protect it from overheating, these openings must not be blocked or covered.

- Do not block the openings by placing the product on a bed, sofa, rug or other similar surface.
- Do not place the product in a built-in installation such as a bookcase or rack unless proper ventilation is provided or the manufacturer's instructions have been adhered to.

6. Wall or Ceiling Mounting

The product should be mounted to a wall or ceiling only as recommended by the manufacturer.

ANTENNA INSTALLATION INSTRUCTIONS

1. Outdoor Antenna Grounding

If an outside antenna or cable system is connected to the product, be sure the antenna or cable system is grounded so as to provide some protection against voltage surges and built-up static charges. Article 810 of the National Electrical Code, ANSI/NFPA 70, provides information with regard to proper grounding of the mast and supporting structure, grounding of the lead-in wire to an antenna discharge unit, size of grounding conductors, location of antenna discharge unit, connection to grounding electrodes, and requirements for the grounding electrode.

2. Lightning

For added protection for this product during a lightning storm, or when it is left unattended and unused for long periods of time, unplug it from the wall outlet and disconnect the antenna or cable system. This will prevent damage to the product due to lightning and power-line surges.

3. Power Lines

An outside antenna system should not be located in the vicinity of overhead power lines or other electric light or power circuits, or where it can fall into such power lines or circuits. When installing an outside antenna system, extreme care should be taken to keep from touching such power lines or circuits as contact with them might be fatal.

EXAMPLE OF ANTENNA GROUNDING AS PER NATIONAL ELECTRICAL CODE, ANSI/NFPA 70

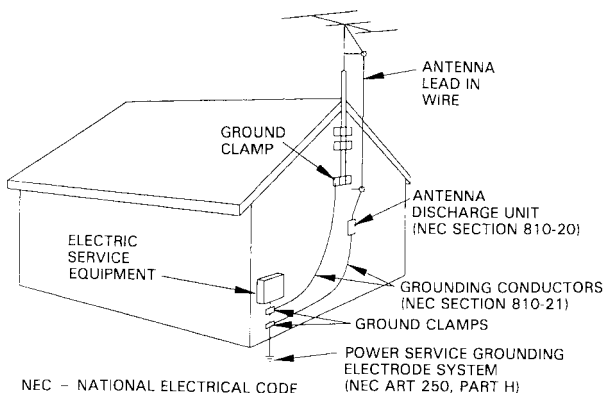

USE

1. Accessories

To avoid personal injury:

- Do not place this product on an unstable cart, stand, tripod, bracket, or table. It may fall, causing serious injury to a child or adult, and serious damage to the product.
- Use only with a cart, stand, tripod, bracket, or table recommended by the manufacturer or sold with the product.
- Use a mounting accessory recommended by the manufacturer and follow the manufacturer's instructions for any mounting of the product.
- Do not try to roll a cart with small casters across thresholds or deep-pile carpets.

PORTABLE CART WARNING
(Symbol provided by RETAC)

2. Product and Cart Combination

A product and cart combination should be moved with care. Quick stops, excessive force, and uneven surfaces may cause the product and cart combination to overturn.



3. Water and Moisture

Do not use this product near water—for example, near a bath tub, wash bowl, kitchen sink or laundry tub, in a wet basement, or near a swimming pool and the like.

4. Object and Liquid Entry

Never push objects of any kind into this product through openings as they may touch dangerous voltage points or short-out parts that could result in a fire or electric shock. Never spill liquid of any kind on the product.

5. Attachments

Do not use attachments not recommended by the manufacturer of this product as they may cause hazards.

6. Cleaning

Unplug this product from the wall outlet before cleaning. Do not use liquid cleaners or aerosol cleaners. Use a damp cloth for cleaning.

7. Heat

The product should be situated away from heat sources such as radiators, heat registers, stoves, or other products (including amplifiers) that produce heat.

SERVICING

1. Servicing

If your product is not operating correctly or exhibits a marked change in performance and you are unable to restore normal operation by following the detailed procedure in its operating instructions, do not attempt to service it yourself as opening or removing covers may expose you to dangerous voltage or other hazards. Refer all servicing to qualified service personnel.

2. Damage Requiring Service

Unplug this product from the wall outlet and refer servicing to qualified service personnel under the following conditions:

- a. When the power supply cord or plug is damaged.
- b. If liquid has been spilled, or objects have fallen into the product.
- c. If the product has been exposed to rain or water.
- d. If the product does not operate normally by following the operating instructions. Adjust only those controls that are covered by the operating instructions as an improper adjustment of other controls may result in damage and will often require extensive work by a qualified technician to restore the product to its normal operation.
- e. If the product has been dropped or damaged in any way.
- f. When the product exhibits a distinct change in performance—this indicates a need for service.

3. Replacement Parts

When replacement parts are required, be sure the service technician has used replacement parts specified by the manufacturer or have the same characteristics as the original part. Unauthorized substitutions may result in fire, electric shock or other hazards.

4. Safety Check

Upon completion of any service or repairs to this product, ask the service technician to perform safety checks to determine that the product is in safe operating conditions.

Free Manuals Download Website

<http://myh66.com>

<http://usermanuals.us>

<http://www.somanuals.com>

<http://www.4manuals.cc>

<http://www.manual-lib.com>

<http://www.404manual.com>

<http://www.luxmanual.com>

<http://aubethermostatmanual.com>

Golf course search by state

<http://golfingnear.com>

Email search by domain

<http://emailbydomain.com>

Auto manuals search

<http://auto.somanuals.com>

TV manuals search

<http://tv.somanuals.com>