

JVC



DOUBLE CASSETTE DECK

TD-W354 B/J

Area suffix

B U.K.
J U.S.A.

COMPU LINK
Component

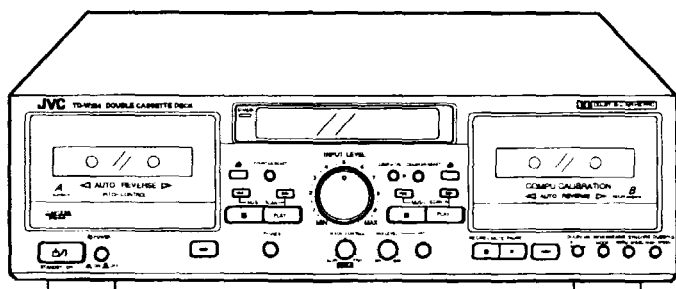

(B version)

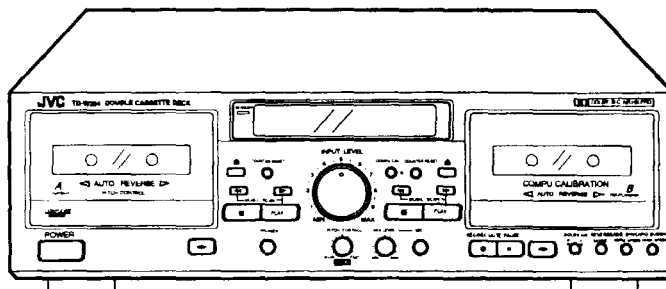



(J version)

INSTRUCTIONS

For Customer Use:

Enter below the Model No. and Serial No. which are located on the rear of the cabinet. Retain this information for future reference.

Model No. _____

	CAUTION RISK OF ELECTRIC SHOCK DO NOT OPEN	
<p>CAUTION "TO REDUCE THE RISK OF ELECTRIC SHOCK DO NOT REMOVE COVER (OR BACK) NO USER SERVICEABLE PARTS INSIDE REFER SERVICING TO QUALIFIED SERVICE PERSONNEL."</p>		



The lightning flash with arrowhead symbol, within an equilateral triangle, is intended to alert the user to the presence of uninsulated "dangerous voltage" within the product's enclosure that may be of sufficient magnitude to constitute a risk of electric shock to persons.



The exclamation point within an equilateral triangle is intended to alert the user to the presence of important operating and maintenance (servicing) instructions in the literature accompanying the appliance.

WARNING:

TO REDUCE THE RISK OF FIRE OR ELECTRIC SHOCK, DO NOT EXPOSE THIS APPLIANCE TO RAIN OR MOISTURE.

IMPORTANT (In the United Kingdom)

Mains Supply (AC 230 V ~, 50 Hz only)

DO NOT cut off the mains plug from this equipment. If the plug fitted is not suitable for the power points in your home or the cable is too short to reach a power point, then obtain an appropriate safety approved extension lead or consult your dealer.

BE SURE to replace the fuse only with an identical approved type, as originally fitted and to replace the fuse cover.

If nonetheless the mains plug is cut off ensure to remove the fuse and dispose of the plug immediately, to avoid a possible shock hazard by inadvertent connection to the mains supply.

DO NOT make any connection to the terminal which is marked with the letter E or by the safety earth symbol or coloured green or green-and-yellow.

The wires in the mains lead on this product are coloured in accordance with the following code:



Blue to N
(Neutral) or Black
Brown to L
(Live) or Red

As these colours may not correspond with the coloured markings identifying the terminals in your plug proceed as follows:

The wire which is coloured blue must be connected to the terminal which is marked with the letter N or coloured black.

The wire which is coloured brown must be connected to the terminal which is marked with the letter L or coloured red.

IF IN DOUBT-CONSULT A COMPETENT ELECTRICIAN.

Please study this instruction manual carefully before starting to operate the unit, in order to use the unit correctly. We take no responsibility for any problems resulting from misuse of this unit by operating this equipment other than instructed in this manual.

WARNING (In the United Kingdom)

Pre-recorded tapes, records or discs should not be re-recorded without the consent of the owners of copyright in the sound recording and in any copyright musical or literary work embodied in that recording as this constitutes an infringement of copyright.

INFORMATION (FOR U.S.A.)

This equipment has been tested and found to comply with the limits for a Class B digital device, pursuant to Part 15 of the FCC Rules. These limits are designed to provide reasonable protection against harmful interference in a residential installation. This equipment generates, uses, and can radiate radio frequency energy and, if not installed and used in accordance with the instructions, may cause harmful interference to radio communications. However, there is no guarantee that interference will not occur in a particular installation. If this equipment does cause harmful interference to radio or television reception, which can be

determined by turning the equipment off and on, the user is encouraged to try to correct the interference by one or more of the following measures:

- Reorient or relocate the receiving antenna.
- Increase the separation between the equipment and receiver.
- Connect the equipment into an outlet on a circuit different from that to which the receiver is connected.
- Consult the dealer or an experienced radio/TV technician for help.

INTRODUCTION

Thank you for purchasing a JVC product. Read this instruction book carefully before operating to be sure of getting optimum performance and longer service life from the unit.

CONTENTS

Features	3
Auto reverse operation	3
Cautions	3
Connections	5
Cassette loading	5
Names of parts and their functions	6
Playback	7
Multi music scan	8
Recording	8
Compu link control system	11
Dubbing	12
Maintenance	13
Troubleshooting	14
Specifications	15

FEATURES

1. **Double auto-reverse mechanism for recording/playback in deck B and playback in deck A**
2. **COMPU CAL function which automatically sets the flat characteristics and brings out maximum tape performance.**
3. **Full logic mechanism**
4. **Dolby[®] HX PRO headroom extension**
5. **Dolby B & C noise reduction system**
6. **DDRP (Dynamics Detection Recording Processor) compatibility**
The DDRP function is possible only when used with a suitable JVC CD player.
7. **2-color FL peak level indicator**
8. **Digital tape counter respectively for deck A and deck B**
9. **Synchro start (normal/high-speed) dubbing**
10. **Auto tape select mechanism (decks A and B)**
11. **Multi music scan mechanism for either direction**
"Under License of Staar S.A., Brussels, Belgium"
12. **PITCH control**
13. **Microphone mixing is possible**
14. **COMPU LINK-3 compatible**

- * Dolby noise reduction and HX Pro headroom extension manufactured under license from Dolby Laboratories Licensing Corporation. HX Pro originated by Bang & Olufsen.
- * "Dolby", the double-D symbol  and "HX PRO" are trademarks of Dolby Laboratories Licensing Corporation.

COMPU LINK control system is the convenient system using COMPU LINK-3/SYNCHRO terminals on the rear panel. (See page 5 and 11.)

D·D·R·P

DYNAMICS DETECTION RECORDING PROCESSOR

This product can be combined with a DDRP (DYNAMICS DETECTION RECORDING PROCESSOR) system (compact disc player + cassette deck, etc.) to enable setting the optimum recording level automatically. Refer to these instructions for details.

AUTO REVERSE OPERATION

The auto reverse operation of this unit turns the tape transport over to the reverse of forward direction automatically when the tape reaches its end during recording or playback.

- * Because of cassette shell construction, a tape recorded in the forward direction should be played back in the same direction to obtain stable sound reproduction.
- * During recording, auto reverse can be activated only from the forward to the reverse direction. For good sound quality and to avoid accidental erasure of previously recorded material, always start recording with the side A of the tape facing out.

CAUTIONS

1. **Prevention of Electric Shocks, Fire Hazards and Damage**
 - 1) Even when the POWER switch is set to STANDBY, a very small current will flow. To save power and for safety when not using the unit for an extended period of time, disconnect the power cord from the household AC outlet. (**For J version**)
 - 2) Do not handle the power cord with wet hands.
 - 3) When unplugging from the wall outlet, always grasp and pull the plug, not the power cord.
 - 4) Consult your nearest dealer when damage, disconnection, or contact failure is found with the cord.
 - 5) Do not bend the cord sharply, or pull or twist it.
 - 6) Do not modify the power cord in any manner.
 - 7) Do not remove screws to disassemble the unit and do not touch anything inside the unit.
 - 8) **AC power cord (For J version only)**
The AC power cord of this unit has certain one-way direction connections to prevent electric shock. Refer to the illustration for correct connection. (Fig. 1)

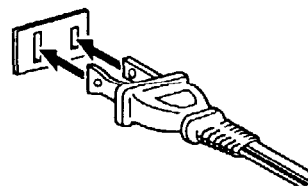

Fig. 1

(For CANADA)

CAUTION

TO PREVENT ELECTRIC SHOCK, MATCH WIDE BLADE OF PLUG TO WIDE SLOT, FULLY INSERT.

(Pour le CANADA)
ATTENTION
POUR EVITER LES CHOCS ELECTRIQUES, INTRODUIRE
LA LAME LA PLUS LARGE DE LA FICHE DANS LA
BORNE CORRESPONDANTE DE LA PRISE ET POUSSER
JUSQU'AU FOND.

- 9) Do not insert any metallic objects into the unit.
- 10) Unplug the power cord when there is a possibility of lightning.
- 11) If water gets inside the unit, unplug the power cord from the outlet and consult your dealer.
- 12) Do not block the ventilation holes of the unit so that heat can escape. Do not install the unit in a badly ventilated place.
- 13) Be sure to unplug the power cord from the outlet when going out or when the unit is not in use for an extended period of time.

2. Installation

- 1) Avoid placing the unit on or adjacent to an amplifier, to prevent hum from being produced by some types of amplifiers. Move the unit to a place not affected by the amplifier. Keep the unit as far as possible from a TV set.
- 2) Avoid installing the unit in a location subject to ambient temperatures exceeding 40 °C (104 °F) (e.g. direct sunlight, near heaters, etc.) or less than 0 °C (32 °F), excessive humidity, dust or vibrations.
- 3) If this set is moved suddenly from a cold place (0 °C) to a warm place, it may not function properly because of moisture generated inside the unit. The unit will function properly 30 minutes after being moved.

3. Cleaning the cabinet

Never use benzine or thinner for cabinet cleaning as they may damage the surface finish.

4. Cassette tape

- 1) Loose tape may become tangled in the tape transport mechanism. Remove slack by winding the tape with a pencil.
 (Fig. 2)

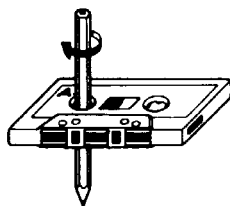

Fig. 2

Turn the pencil to tighten the tape.

- 2) The use of C-120 (120 minutes turn around) or thinner tape is not recommended, since characteristic deterioration may occur.
- 3) To prevent recordings from being erased accidentally, remove the tab(s) with a screwdriver. Reseal the slots with adhesive tape to erase and re-record after the tabs have been broken off.

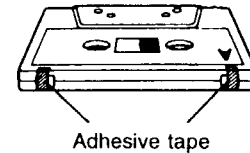
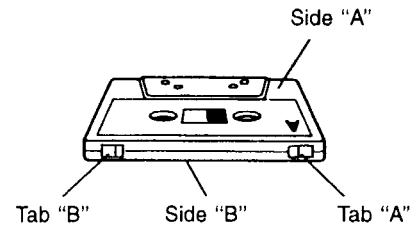

Fig.

- 4) Do not store cassette tapes where there is a magnetic field (e.g. near a TV, etc.) or in a place subject to high temperatures or humidity.

5. Auto tape select mechanism (decks A and B)

This deck has an Auto Tape Select mechanism which distinguishes between different types of tape from holes in cassette. After the type of tape has been detected, bias and equalization are set to be suitable for the tape.

- Cassettes with the detection holes:

Metal tape (EQ: 70µs) Type
 CrO₂ (chrome) tape (EQ: 70µs) Type

- Cassettes without the detection holes:

Normal tape (EQ: 120µs) Type

Some earlier types of metal and CrO₂ (chrome) tapes are not provided with the detection holes. Avoid using such tapes, since correct equalization characteristics cannot be obtained. Also do not use ferrichrome tapes whose characteristics do not match this unit.

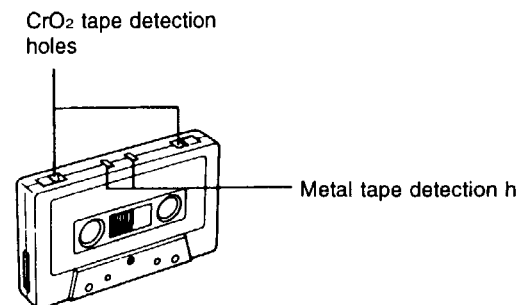

6. Operations

- 1) Noise may be generated if the power is on or in standby when the deck is set to playback or recording mode. Before turning the power on or setting to standby, confirm that the ■ (stop) button has been pressed.
- 2) Many operations of this unit are performed under the control of a microcomputer. Use the unit only after carefully studying the descriptions and cautions in each item. If operations are done incorrectly, the unit may stop functioning correctly. If this happens, turn off the power once, and then turn it on again, so that the unit can function correctly.

CONNECTIONS

- Do not switch the power on until all the connections are completed.
- Insert the plugs firmly, or poor contact will result, causing noise.
- When the pin-plug cords are employed, always connect the white plug to the left channel terminal. This helps to avoid reversed connections.
- When using the Compu Link Control System version 3, do not connect the power cord to the SWITCHED AC OUTLET of an amplifier or receiver. In the **B version**, turn the deck ① POWER switch ON. Otherwise, the automatic power on/off (STANDBY) function cannot be carried out.

1. Connection to a stereo amplifier

Note:

When installing the deck, be sure to install at a distance from your amplifier. If they are stacked, noise (hum) may occur.

2. Remote cable connection for COMPU LINK

- By connecting a remote cable, COMPU LINK functions (automatic power on/off (STANDBY), automatic source selection, synchronized recording and DDRP recording) can be performed. In this time the provided pin-plug cords must be also connected.
- When making synchronized recording with a CD player, connect the remote cable to the COMPU LINK-1/SYNCHRO or COMPU LINK-3/SYNCHRO jacks.

Notes:

1. When making synchronized recordings, only a single deck should be connected to the amplifier.
2. If a component is not a JVC COMPU LINK component, bypass it when making the remote cable connections.
3. This deck can be connected with an amplifier and a CD player which have the COMPU LINK-1/SYNCHRO jacks for COMPU LINK performance. (See page 11 for details.)

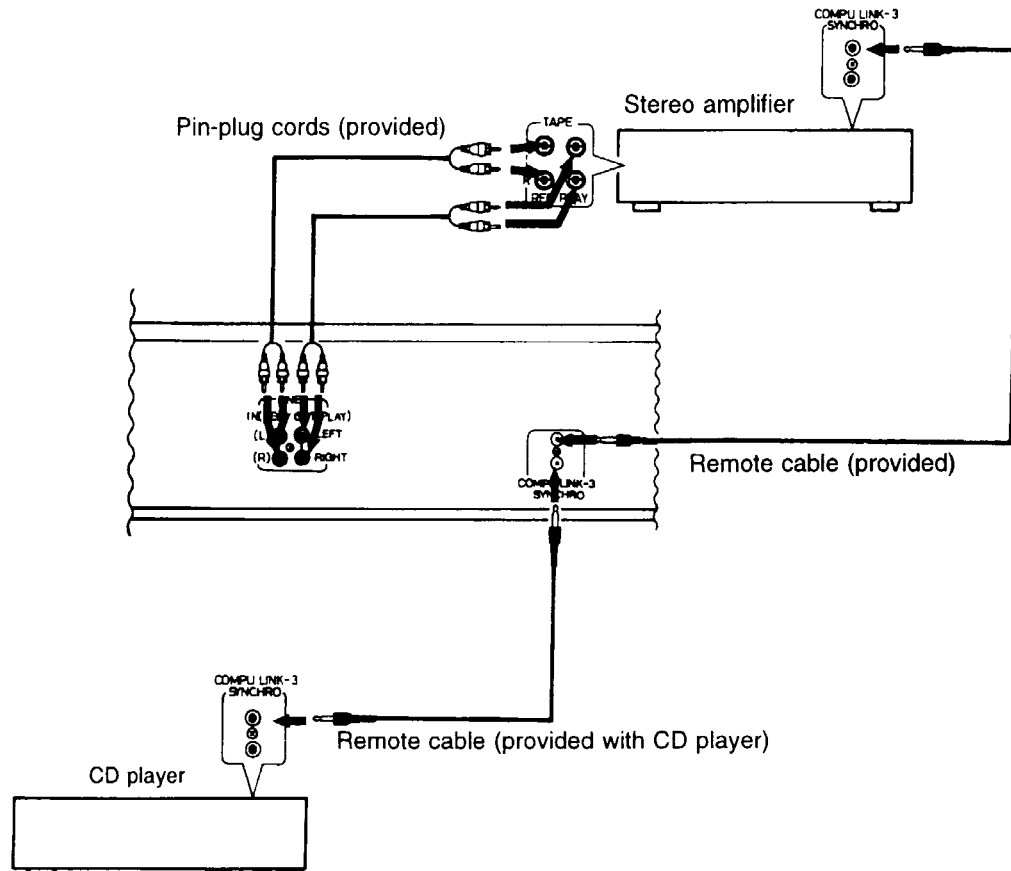

CASSETTE LOADING

1. Press the Δ (eject) button to open the cassette holder.
2. Load a cassette as shown.
3. Press the cassette holder to close it. Be sure to obtain the click sound to close the holder securely.

Notes for B version:

- If the ① POWER switch is set to OFF while the tape is moving, you might not be able to remove the cassette. If this happens, switch the power on again before attempting to remove the cassette.

- Setting the ① POWER switch to OFF during playback may cause a malfunction. Always stop playback before setting the ① POWER switch to OFF.

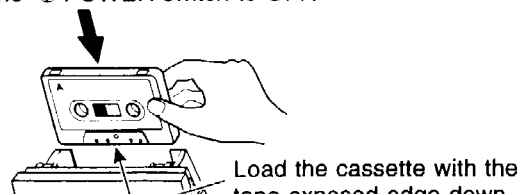

NAMES OF PARTS AND THEIR FUNCTIONS

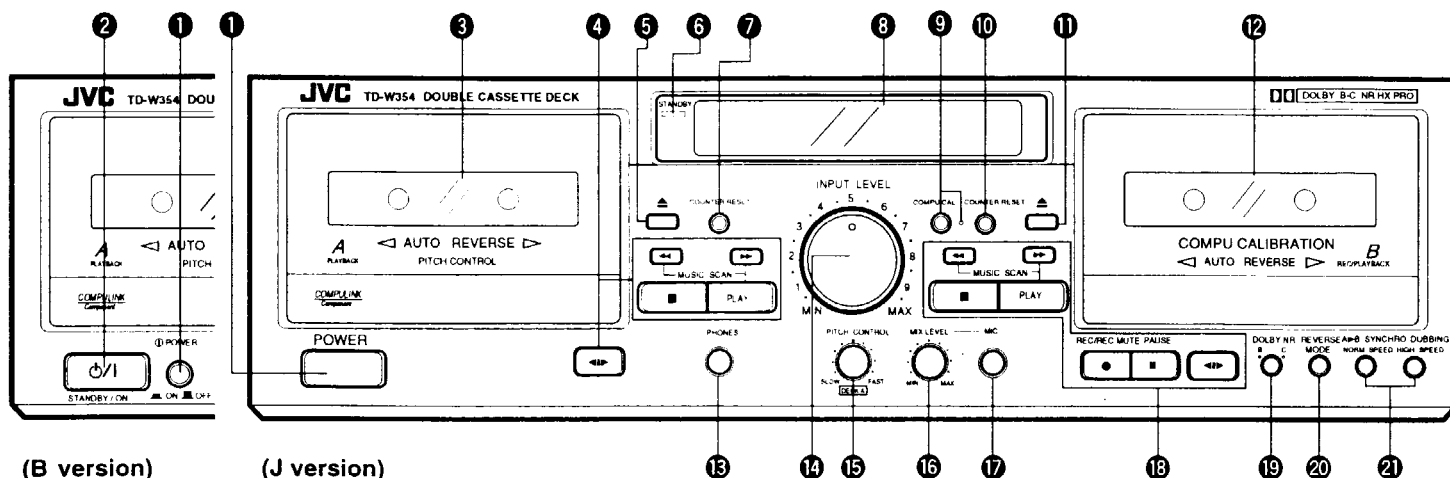

① ① POWER switch (ON OFF) (B version)
POWER switch (On/Standby) (J version)

② switch (STANDBY/ON) (B version)

③ Cassette holder (deck A)

④ Cassette operation buttons (deck A)

: Press to wind the tape quickly from right to left.

: Press to wind the tape quickly from left to right.

PLAY : Press to play the tape.

(stop) : Press to stop the tape.

(direction) : Press to change the direction of tape travel.

⑤ (eject) button (deck A)

⑥ Power STANDBY indicator

Lights when in the power standby mode.

⑦ COUNTER RESET button (deck A)

Press this button to set the digital counter to "00 00".

Even if the POWER switch is set to STANDBY, the counter value at that time is stored in memory.

⑧ Indicators

① DDRP indicator

② Peak level indicator

These indicators light according to the level of the signal being recorded or the level of the signal recorded on the tape.

Note:

0 dB : IEC (DIN) STANDARD LEVEL (250 nWb/m)

0 VU : Signal level at 160 nWb/m

③ HX PRO indicator

④ Digital counter

The counter reading increases while the tape is running forward and decreases when it is running in reverse. In the Multi Music Scan mode when the (or) button is pressed, the number of tunes which will be skipped is displayed.

⑤ Mechanism mode indicators (deck A)

: This lights when rewinding the tape from left to right.

: This lights when rewinding the tape from right to left.

⑥ DUBBING >> : ">" lights when in the normal-speed dubbing mode.

">>" lights when in the high-speed dubbing mode.

⑦ CONT : Lights when the unit is in the continuous play mode.

⑧ Mechanism mode indicators (deck B)

PLAY : Lights when the unit is in the playback and record modes.

: Indicates the direction of tape travel.

REC : Lights when the unit is in the record and record-pause modes; blinks during record muting.

: Pause indicator

: This lights when rewinding the tape from left to right.

: This lights when rewinding the tape from right to left.

⑨ : Indicates reverse mode.

⑨ COMPU CAL button and indicator

Press this button to automatically set the recording characteristics with the COMPU CAL function. (See page 9.)

⑩ COUNTER RESET button (deck B)

⑪ (eject) button (deck B)

⑫ Cassette holder (deck B)

⑬ PHONES jack

Connects headphones (with an impedance of 8 Ω to 1 kΩ).

⑭ INPUT LEVEL control

⑮ PITCH CONTROL (deck A)

Varies the tape speed in deck A in the range of about ±10%. However, it cannot change the tape speed in the high-speed dubbing.

Turning it counterclockwise toward "SLOW" causes the tape speed to decrease while turning clockwise toward "FAST" causes it to increase. The center click position is for the standard speed. (See page 8.)

⑯ Mixing microphone level control

Adjusts the microphone input level.

⑰ MIX MIC jack

Connects a microphone (with an impedance of 600 Ω to 10 kΩ) to this jack.

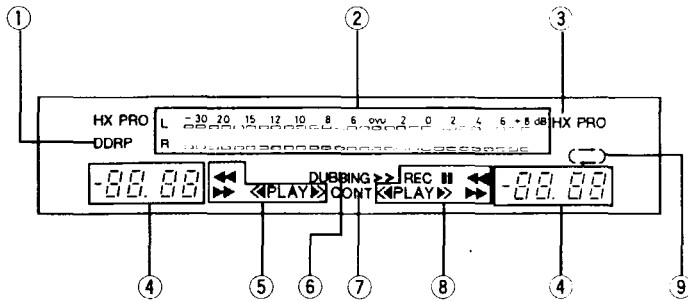

18 Cassette operation buttons (deck B)

- : Press to wind the tape quickly from right to left.
- : Press to wind the tape quickly from left to right.
- (stop) : Press to stop the tape. Also press to stop both decks simultaneously during dubbing.
- PLAY : Press to start playback/recording.
- REC/ : Press the PLAY button while pressing this button to start recording, and press to leave an appropriate non-recorded section. (See page 10.)
- REC MUTE
- PAUSE : Press to stop the tape temporarily during recording and playback. Press the PLAY button to release the pause mode.
- (direction) : Press to change the direction of tape travel.

19 DOLBY NR button and indicators

Set to B or C for recording using the Dolby NR system or for playing back a tape that was recorded using the Dolby NR system. Each time the button is pressed the NR mode changes and the indicator lights. (Dolby B NR -> Dolby C NR -> NR OFF -> Dolby B NR ...)

Set to OFF when the Dolby NR system is not used.

20 REVERSE MODE switch

Select the single side or full record/playback mode, or the continuous play mode. Each time the button is pressed the mode changes. (-> -> -> ...) The current mode can be checked with the mechanism mode indicator.

- : For single-side recording or playback.
- : To play or record both sides A and B.
- : To play sides A and B continuously.

21 A ▶ B SYNCHRO DUBBING buttons

Press to dub from deck A to deck B.

- NORM SPEED : Press to perform normal-speed dubbing.
- HIGH SPEED : Press to perform high-speed dubbing.

PLAYBACK

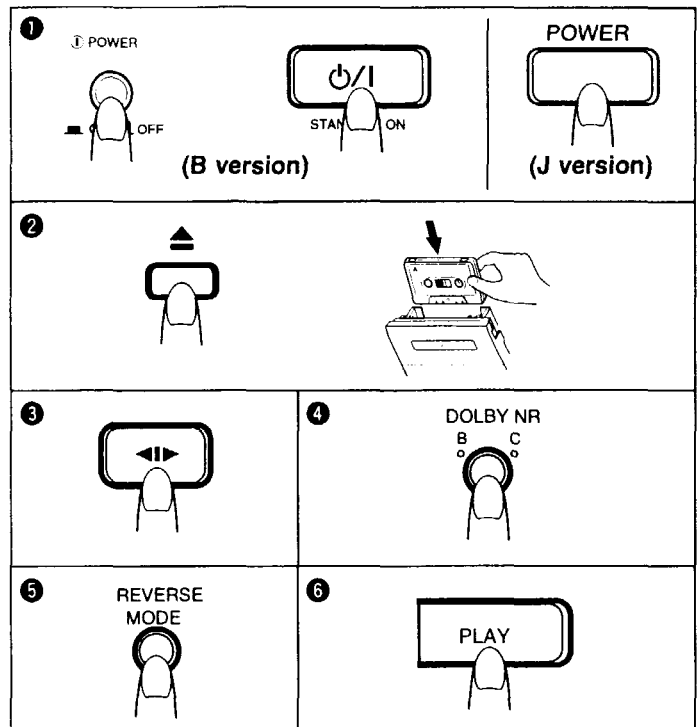

Playback of deck A

Operate in the order of the numbers in the illustration.

- 1 Turn the power on.
 - 2 Load a prerecorded cassette with side A facing out.
 - 3 Select the side to be played back.
Side A... Forward direction (PLAY)
Side B... Reverse direction (PLAY)
 - 4 Set the DOLBY NR switch to the same setting as when the tape was recorded.
 - 5 Select the REVERSE MODE.
 - 6 Press the PLAY button of deck A to start playback.
- When the deck contains a tape, the deck is turned on automatically and the tape is played back by only pressing the PLAY button.

Playback of deck B

Perform steps 2 to 6 of the above procedure for deck B.

Microphone mixing during playback

By connecting a microphone, microphone mixing with playback sound from deck A or deck B is possible.

Continuous play

First set the REVERSE MODE switch to .

Load cassette tapes in both decks and press the PLAY button of the deck to be played first for continuous play of both decks.

- At this time, the CONT indicator lights in the multimode display. When the tape in the deck which plays first reaches the end of side B (in the reverse direction), it automatically switches to the forward direction and enters the standby mode. At the same time, the other deck starts playback. These operations continue between decks A and B.

- While one deck is playing back, the cassette in the other one can be replaced. This is convenient for long-time playback of background music.

Note:

PITCH control (deck A)

It is possible to vary the tape speed in deck A in the range of about $\pm 10\%$ in the playback mode. The center click position is for the standard tape speed.

MULTI MUSIC SCAN

- The multi music scan mechanism of this unit allows you to quickly locate the beginning of a specific tune (up to 99 tunes before or after the current tune).
 - The multi music scan mechanism functions by detecting non-recorded sections between tunes (of more than 4–5 sec.).
 - The illustration shows the forward direction.
- Example of fast forward scan.

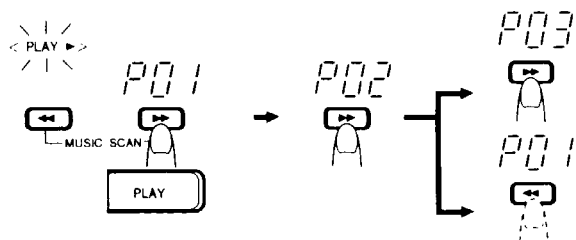

Procedure

1. Press the **▶▶** button during playback.
2. When more than 2 tunes are to be skipped, after procedure 1 press the **▶▶** (or **◀◀**) button the number of times you want to skip tunes. The number of tunes to be skipped is displayed in the counter.

Relation between Multi Music Scan and REVERSE MODE.

- ➡ : The multi music scan mechanism operates on one side of the tape only. If the number set is too high (more than there are tunes remaining on that side), the tape stops when the end of the tape is reached.
- ↔ : It operates continuously through one cycle of the A and B sides of the tape. If the number set has not been reached, the tape stops at the end of the B side. When the head rotates to play side A from B or B from A, this rotation is counted as one non-recorded section. When a recorded tune continues from side A to B, this tune is recorded as two tunes. In such a case, press the **◀◀** (or **▶▶**) button one extra time.

Notes:

In the following cases, the mechanism may not operate correctly. This is not a malfunction; use the mechanism according to the type of program.

- Tapes with tunes having long pianissimo passages (very quiet parts) or non-recorded portions during tunes.
- Tapes with short non-recorded sections.

RECORDING

Deck B only

Operate in the order of the numbers in the illustration.

- Make sure the safety tab of the cassette has not been broken off.

It should be noted that it may be unlawful to re-record pre-recorded tapes, records, or discs without the consent of the owner of copyright in the sound or video recording, broadcast or cable programme and in any literary, dramatic, musical, or artistic work embodied therein.

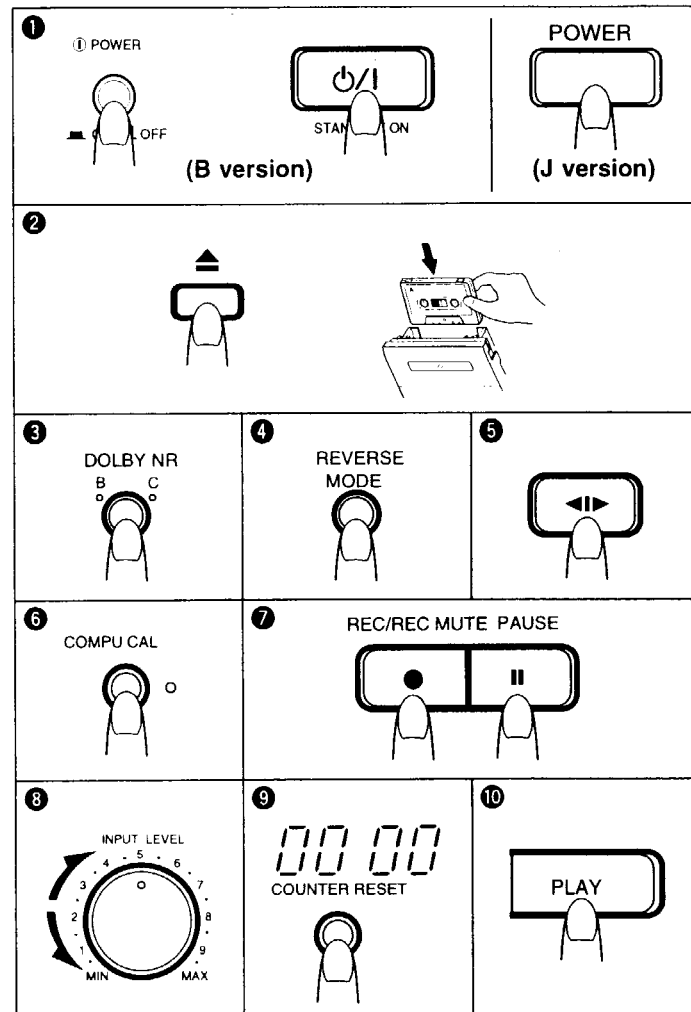

- 1 Turn the power on.
- 2 Load a cassette for recording.
- 3 Set the DOLBY NR switch as required.
- 4 Set the REVERSE MODE switch as desired.
- 5 Select the side to be recorded.
- 6 Press the COMPU CAL button, if required. (See page 9.)
- 7 Press the **||** PAUSE button and **●** REC/REC MUTE button (record-pause mode).
REC and **||** indicators light.
- 8 Adjust the recording level. (See page 10.)
- 9 Press to "00 00".
- 10 Press the PLAY button to start recording.

Notes:

- When the safety tabs are removed from a cassette tape, the tape cannot be recorded even if you try. Make sure that both

- When the tape is played or recorded in the reverse direction (side B), only side B is played back or recorded and then the tape stops automatically.

DDRP (Dynamics Detection Recording Processor) recording

DDRP recording is performed with suitable JVC CD players and the recording level adjustment is performed automatically. Since recording level adjustment is performed automatically for different types of tape (normal, CrO₂ and metal), the adjustment of INPUT LEVEL control is not required. Read the instruction book of your CD player carefully.

COMPU CALIBRATION (COMPU CAL) FUNCTION

- This unit is equipped with a COMPU CAL function which can automatically set the flat frequency characteristics and optimal tape sensitivity for each tape in approximately 30 seconds. Calibration data is retained for each tape type (Type I, II or IV).
- Calibration data set with COMPU CAL is retained even if the power is turned off (or the power cord is unplugged), and the previous calibration data for the same type of tape as the new tape is recalled each time tapes are changed.
- Performing COMPU CAL operations again replaces existing data with the new data.

COMPU CAL operation

- Insert the tape to be recorded and press the COMPU CAL button. During the operation, "C" -> "CA" -> "CAL" is displayed in the tape counter. When the operation finishes, the tape returns to its starting position, and the COMPU CAL indicator lights. COMPU CALIBRATION is now finished.
- Pressing the ■ (stop) button part-way will interrupt the operations.
- To recalibrate the unit, press the COMPU CAL button and wait for the COMPU CAL indicator to go out. Then, press the COMPU CAL button again.

Note:

If the tape is near its end, it will automatically stop and an error will be generated during operation. Therefore, be sure to check the time remaining on the tape (more than 2 minutes in the play mode) before starting the operations.

COMPU CAL Errors

- When the COMPU CAL indicator flashes, this indicates a COMPU CAL error.
- Press the ■ (stop) button to stop the error indication.

Care should be taken for the following items as they are the cause of errors.

- 1) Dirty heads -Clean the heads.
- 2) Scratches on the tape surface -Replace with an undamaged tape.
- 3) When the tape ends part-way through the operations -Change the tape position.
- 4) In rare cases, tapes may have characteristics which fall outside the COMPU CAL setting range.

- When an error occurs or when COMPU CAL operations are interrupted, calibration data cannot be stored in the memory. If settings were previously performed, the previous setting values are retained.
- After confirming items 1) to 3) above and stopping the error indication if there are no problems, even tapes which experience errors can be recorded on using either ① the unit's preset values or ② previous setting values. (These are the values obtained by opening and closing the cassette holder one time.)
 - * Preset value: a standard value corresponding to each type of tape, which allows normal recording. (The preset value condition is in effect when the COMPU CAL indicator is unlit.)

Notes:

1. Since COMPU CAL operations record a test tone on tapes, previously recorded contents will be erased.
2. Using new tapes and cleaning the heads beforehand are recommended for optimal COMPU CAL operations.
3. Some variance in characteristics exists even with the same type of tape made by the same manufacturer. Therefore, when precise settings are desired, performing COMPU CAL operations for each recording is recommended.
4. To delete contents set with COMPU CAL, simultaneously press the ●REC/REC MUTE and B deck COUNTER RESET buttons. This deletes the calibration data for the type of tape currently inserted in the unit. Calibration data for other tape types is not deleted.

MICROPHONE MIXING DURING RECORDING

By connecting a microphone, microphone mixing during recording is possible by following the recording procedure. Adjust the microphone input level by setting the record-pause mode and observing the peak level indicators.

- When the record-pause mode is set and the INPUT LEVEL control is set to MIN, sounds are output only from the microphone, and it can be used as a public address system.

RECORDING LEVEL ADJUSTMENT

Adjust the recording level while observing the peak level indicator indication.

For example:
With metal tape

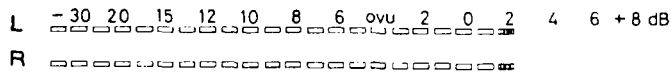

Because of metal tape's higher saturation level, it is OK that "+ 2" lights occasionally.

With normal or chrome tape

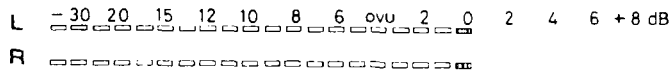

It is OK that "+ 0" lights occasionally.

- When the recording level is too low, the hiss noise inherent in the tape will be conspicuous.
- When the recording level is too high, exceeding the saturation level, the recording will contain cracking noise and will be distorted.
- If "+ 4" lights too often because the recording level is too high, the recorded sound may be distorted and seem to be breaking up. If only "0" lights infrequently, the level is too low and the recording may contain tape hiss.

It is best to adjust so that the maximum sound level of the source to be recorded reaches the very limit of the saturation level of the tape to be used.

The best level varies depending on the type of music and type of tape so it is better to make a test recording, using FM music, records, etc.

AUTOMATIC RECORD MUTING (DECK B)

This facility is used to eliminate undesired sections and leave an appropriate non-recorded section.

A. To leave non-recorded sections of about 4–5 seconds automatically

1. When the undesired section comes during recording, press the ●REC/REC MUTE button and release it.
2. The REC indicator flashes and a non-recorded section is made during record muting operation. About 4–5 seconds later, the tape automatically stops, and the unit enters the record-pause mode.
3. Press the PLAY button to start recording again.

B. To leave non-recorded sections of more than 4–5 seconds

1. Keep the ●REC/REC MUTE button pressed continuously as long as you want to make a non-recorded section. By releasing the finger from the button after the above operation, the unit enters the record-pause mode.
2. Press the PLAY button to start recording again.

C. To leave non-recorded section of less than 4-seconds

When the undesired section comes during recording....

After the ●REC/REC MUTE button is pressed, press the PLAY button before the unit enters the pause mode to start recording again, or press the ■PAUSE button to enter the record-pause mode.

- The peak level indicator lights even during record muting according to the input level which can be heard from the speakers or headphones so that recording can be resumed at the exact point on the tape.

ERASING

When recording on a prerecorded tape, the previous recording is automatically erased and only the new program is recorded on the tape.

To erase a tape without making a new recording...

Follow the section "RECORDING" but in step ⑥, set the INPUT LEVEL control to MIN.

DOLBY NR and DOLBY HX PRO

Dolby NR System

To reduce the hiss inherent in tape recording, use the Dolby NR System when making recordings. When listening to a tape recorded with the Dolby NR System, set the DOLBY NR switch to B or C according to the system selected in the recording mode.

Note:

The sound quality will change if the positions of the DOLBY NR switch are different in recording and playback.

Dolby HX PRO headroom extension

When a source which contains many high-frequency components is recorded, these high-frequency signals have the same function as bias and therefore, the effective bias current changes.

This will result in phenomena such as changes in the level of low-frequency signal and subsequent distortion and reduction of the high-frequency saturation level.

Dolby HX PRO headroom extension system controls the bias current so that the effective bias is constant even when there are fluctuations in the high-frequency components of the input signal.

This greatly improves the high-frequency saturation level while reducing the low-frequency signal level variations and distortion.

- The dynamic sound recorded with this system sounds the same even when the tape is played back in a deck that does not have Dolby HX PRO.

- This system automatically works when in recording; however, Dolby HX PRO is not a noise reduction system.

COMPU LINK CONTROL SYSTEM

The Compu Link Control System controls relative operations between components automatically and facilitates various operations.

This is a system originated and developed by JVC for facilitating various system operations. There are two versions of this system; version 1 and 3. (For version 1 components, "COMPU LINK-1/SYNCHRO" is marked on the rear panel. For version 3 components, "COMPU LINK-3/SYNCHRO" is marked on the rear panel. This unit belongs to version 3.)

The version 3 system controls relative functions between this unit and an amplifier or receiver, in addition to all of the functions of version 1.

Automatic Power On/Off (STANDBY) Function (COMPU LINK-3)

This function is available when an amplifier or receiver having a COMPU LINK-3/SYNCHRO terminal is connected. For example, if a deck contains a tape, the deck is turned on automatically and the tape is played back by only pressing the PLAY button. When the amplifier or receiver is switched STANDBY, the source unit is automatically switched STANDBY. (In the B version, it is necessary to turn the deck $\text{\textcircled{1}}$ POWER switch ON.)

Automatic Source Selection (COMPU LINK-1, 3)

When the provided remote cables are used for connecting this unit to other components which have COMPU LINK-1 or 3/SYNCHRO terminals, the switch-over of all system components is possible with simple one-touch of the source selector button of JVC's amplifier or receiver.

By doing this, the corresponding component will start playing automatically.

The source select button of the remote control unit or the activation button of the desired component can be also used for this purpose. When the components have been switched over, the previous component will stop playing within five seconds.

Synchronized Recording (COMPU LINK-1, 3)

Synchronized recording refers to the process in which the deck starts recording in synchronism with the CD player. Perform the synchronized recording as follows:

1. Set the cassette deck to the record-pause mode in accordance with the recording procedures on page 8.
2. If you want the programmed recording, program the desired tunes in any order you wish to hear.
3. Press the PLAY/PAUSE button of the CD player. By so doing, the cassette deck is placed in the record mode and synchronized with the CD player for recording. Synchronized recording thus can be made possible.

DDRP (Dynamics Detection Recording Processor) recording

The DDRP function makes possible fully automatic recording when used with a suitable JVC CD player. When the DDRP button of a suitable JVC CD player is pressed, the recording level is first adjusted automatically, then recording starts; it is not necessary to start recording by the normal procedure.

Notes:

- Synchronized recording or DDRP recording stops automatically when the CD player stops playing.
- Synchronized recording does not start except when the record-pause mode is set by simultaneously pressing the \bullet REC/REC MUTE and $\text{\textcircled{1}}$ PAUSE buttons in the stop mode.
- To cancel synchronized recording or DDRP recording, press the STOP button of the CD player or cassette deck.
- The source is locked to the CD position during synchronized recording or DDRP recording to avoid accidental stops or switch-over to another component. To switch over the components, cancel synchronized recording or DDRP recording first.
- The INPUT LEVEL control does not function during DDRP recording.

DUBBING

• Synchro dubbing

Operate in the order of the numbers in the illustration.

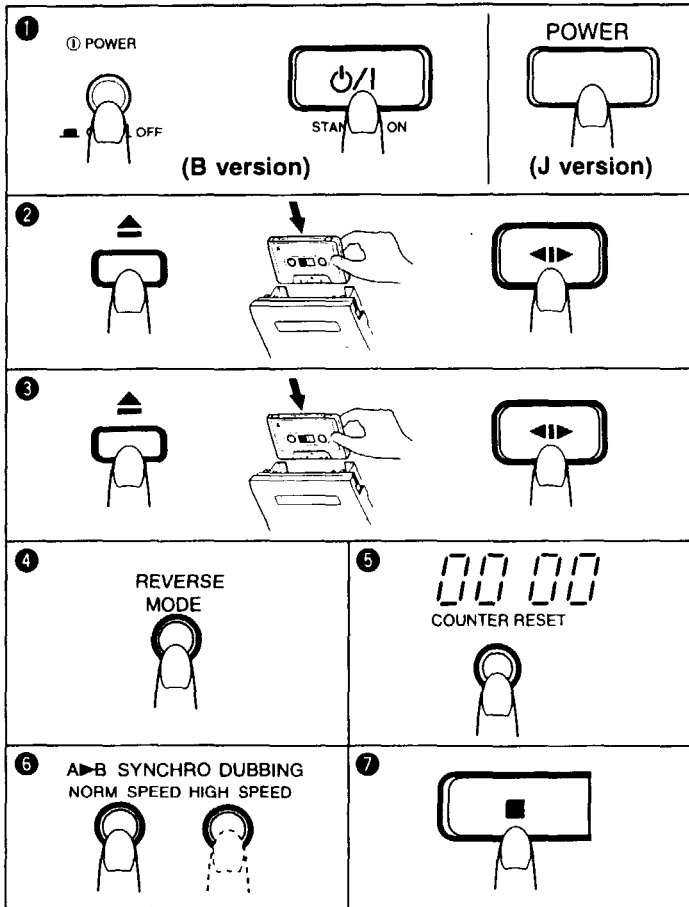

- 1 Turn the power on.
- 2 Insert a prerecorded tape with side A facing out into deck A, and press the ◀▶ (direction) button to select the travel direction.
- 3 Insert the blank tape with side A facing out into deck B, and press the ▶▶ (direction) button to select the side to be recorded.
- 4 Select the REVERSE MODE.
- 5 Press to "00 00". (Deck B)
- 6 Press the SYNCHRO DUBBING (NORM or HIGH SPEED) button to start dubbing.
- 7 Press the ■ (stop) button of deck B to stop dubbing.

When deck B stops, the dubbing mode is automatically released.

• Synchro record muting

When deck A stops or enters any mode other than the playback mode during dubbing, deck B enters the record mute operation automatically and then enters the record-pause mode.

• Before pressing the SYNCHRO DUBBING button

Confirm that deck B is in the stop mode before starting dubbing.

Dubbing and DOLBY NR switch

During dubbing, the same NR mode selected for the playback cassette is applied to the recording cassette, regardless of the position of the NR switch.

Input level

Recording is performed at the same level as the playback tape during dubbing regardless of the position of the INPUT LEVEL control.

Microphone mixing during dubbing

By connecting a microphone, microphone mixing during dubbing is possible with the playback sounds from deck A. Be sure to perform dubbing at normal speed. When performing microphone mixing during dubbing, use cassettes recorded with NR OFF mode for the deck A.

Tape editing

1. Press the ● REC/REC MUTE button when finished dubbing a tune. Deck B automatically enters the record muting mode and leaves a non-recorded section of about 4-seconds then enters the record-paused mode.
2. Press the ■ (stop) button of deck A and search for the next tune you want by using the ▶▶, ◀◀ or PLAY button. Then stop the cassette just before the beginning of the tune.
3. Press the same SYNCHRO DUBBING button pressed before the pause again, and dubbing will start.

Notes at dubbing

1. Normal-speed dubbing is recommended to obtain good sound quality.
2. Television receivers placed close to the deck may cause interference on the recorded signal when the deck is used in the high-speed dubbing mode. If this happens, either turn off the television receiver or use the normal-speed dubbing mode.

MAINTENANCE

The importance of cleaning

When the tape is moving, magnetic powder and dust naturally accumulate on the heads, capstan and pinch roller. When they become too dirty.

- tone quality deteriorates.
- the output sound level drops.
- the previous sound is not erased satisfactorily.
- recordings are not satisfactory.

Because of this, clean the heads, etc. every 10 hours of use so that optimum recordings will be made.

Cleaning the heads, pinch roller and capstan

Wipe the heads, the capstan, etc. with a cotton swab with its tip dipped in alcohol. For effective cleaning, use a cleaning kit available from your audio store. After cleaning, be sure that the cleaning fluid has completely dried before loading a cassette.

Deck B

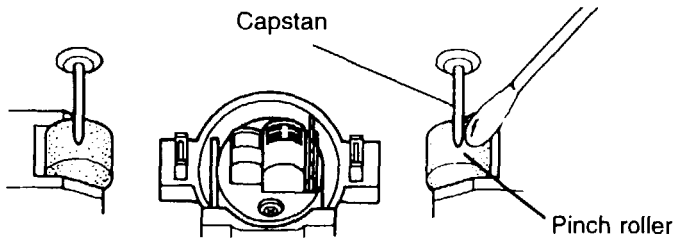

Deck A

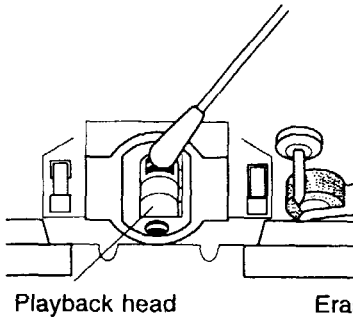

Deck B

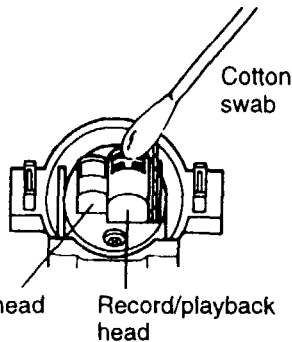

Demagnetizing the heads

Magnetic objects brought close to the head or using the deck for a long period of time, results in magnetization of the head, thus noise occurs. When the noise is excessive, high frequencies on the recorded tape may be erased.

Demagnetize the heads and other metal parts that come into contact with the tape every 20–30 hours of use with a head demagnetizer (available from your audio store).

Example: Deck B

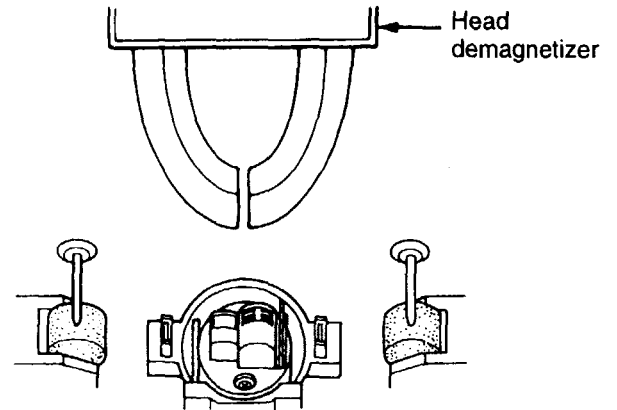

TROUBLESHOOTING

What appears to be trouble is not always real trouble. Make sure first....

1. **Cassette cannot be loaded.**
 - Is the cassette positioned correctly?
2. **When PLAY button is pressed, tape does not move.**
 - Is the tape too loosely wound?
3. **Tape runs, but no sound is heard.**
 - Are all connections properly and securely made?
 - Is the MONITOR switch of the stereo amplifier set to the TAPE position?
 - Is the VOLUME control of the stereo amplifier set to MIN?
4. **Sound quality is poor.**
 - Is the DOLBY NR switch set to the right position?
 - Is the head section dirty?
 - Is the record/playback head magnetized?
 - Is the tape worn out?
5. **Recording cannot be performed.**
 - Are the safety tabs of cassette tape broken?
 - Are all connections properly and securely made?
 - Is the head section dirty?
6. **Previous recording is not completely erased.**
 - Is the erase head dirty?
7. **Since tape speed is irregular, wow and flutter occur.**
 - Is the pinch roller or capstan dirty?
 - Is the tape rewound too tight?
8. **MUSIC SCAN operation does not function properly.**
 - Are the non-recorded sections too short (3 sec. or less), or do they contain high level noise or hum?

SPECIFICATIONS

formed.
 cassette tape broken?
 rly and securely made?
l completely erased.
ular, wow and flutter occur.
 itan dirty?
 ight?
oes not function properly.
 itions too short (3 sec. or less),
 vel noise or hum?

Type : Double cassette deck
Track system : 4-track, 2-channel
Tape speed : 4.8 cm/sec (1-7/8 inch/sec) (Normal)
 9.5 cm/sec (3-3/4 inch/sec) (High)
Frequency response : (-20 dB recording)
 Type IV tape : 20-17,000 Hz
 30-16,000 Hz (± 3 dB)
 Type II tape : 20-16,000 Hz
 30-15,000 Hz (± 3 dB)
 Type I tape : 20-16,000 Hz
 30-15,000 Hz (± 3 dB)
S/N ratio : 58 dB (S = 315 Hz, k3 = 3%,
 N = A-weighted, Type IV tape)
 The S/N is improved by about 15 dB at
 500 Hz and by max. 20 dB at 1 kHz ~
 10 kHz with Dolby C NR on and
 improved by 5 dB at 1 kHz and by
 10 dB at above 5 kHz with DOLBY B
 NR on.
Improvement of MOL : 4 dB at 10 kHz with Dolby C NR on.
Wow and flutter : 0.08% (WRMS), $\pm 0.2\%$ (DIN/IEC)
Channel separation : 40 dB (1 kHz)
Crosstalk : 60 dB (1 kHz)
Harmonic distortion : k3; 0.8% (Type IV tape, 315 Hz, 0 VU)
Heads : Deck A; METAPERM head for playback
 x 1
 Deck B; METAPERM head for
 recording/playback, 2-gap fer-
 rite head for erasure; combina-
 tion head x 1

Motors : Electric governed DC motor for capstan
 x 1
 DC motor for reel x 1
 DC motor for mechanism drive x 1
 (For both decks A and B)
Fast forward/rewind time : Approx. 110 sec. with C-60 cassette
Input terminals
LINE IN : Input sensitivity; 80 mV (0 VU)
 (x 1 circuit) Input impedance; 50 k Ω
MIC x 1 : Input sensitivity; 0.4m V (-68dBV)
 (0 VU)
 Matching impedance; 600 ~ 10 k Ω
Output terminals
LINE OUT : Output level; 300 mV (0 VU)
 (x 1 circuit) Output impedance; 5 k Ω
PHONES x 1 : Output level; 0.3 mW/8 Ω (0 VU)
 Matching impedance 8 Ω -1 k Ω
Other terminals : COMPU LINK-3/SYNCHRO x 2
Power requirement : AC 230 V, 50 Hz (B version)
 AC 120 V, 60 Hz (J version)
Power consumption : With power on 17 W
 With power standby 4.0 W
Dimensions (W x H x D) : 435 x 139 x 331 mm
 (17-3/16" x 5-1/2" x 13-1/16")
Mass : 5.1 kg (11.3 lbs.) (B version)
 5.0 kg (11.1 lbs.) (J version)
Accessories : Pin plug cord 2
 Remote cable 1

Design and specifications are subject to change without notice.

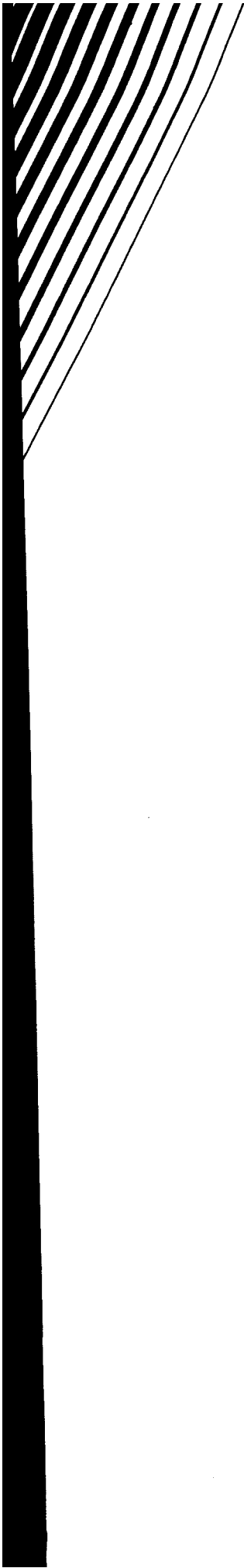

JVC
VICTOR COMPANY OF JAPAN, LIMITED

Free Manuals Download Website

<http://myh66.com>

<http://usermanuals.us>

<http://www.somanuals.com>

<http://www.4manuals.cc>

<http://www.manual-lib.com>

<http://www.404manual.com>

<http://www.luxmanual.com>

<http://aubethermostatmanual.com>

Golf course search by state

<http://golfingnear.com>

Email search by domain

<http://emailbydomain.com>

Auto manuals search

<http://auto.somanuals.com>

TV manuals search

<http://tv.somanuals.com>