



## MULTI-FORMAT MONITOR

# DT-V1700CG

## INSTRUCTIONS

### For Customer Use:

Enter below the Serial No. which is located on the rear of the cabinet. Retain this information for future reference.

Model No. : **DT-V1700CG**

Serial No. : \_\_\_\_\_

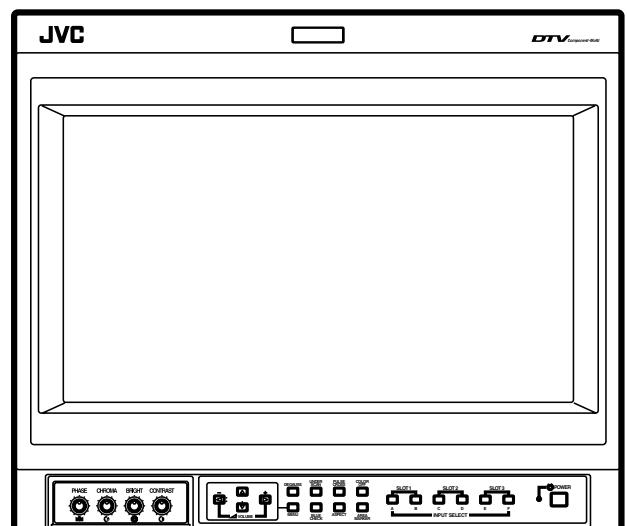

The illustration above shows the DT-V1700CG with provided wide mask attached.

# SAFETY PRECAUTIONS

In order to prevent any fatal accidents caused by misoperation or mishandling the monitor, be fully aware of all the following precautions.

## WARNINGS

To prevent fire or shock hazard, do not expose this monitor to rain or moisture. Dangerous high voltages are present inside the unit. Do not remove the back cover of the cabinet. When servicing the monitor, contrast qualified service personnel. Never try to service it yourself.

## WARNING : THIS APPARATUS MUST BE EARTHED.

Improper operations, in particular alternation of high voltage or changing the type of tube may result in x-ray emission of considerable dose. A unit altered in such a way no longer meets the standards of certification, and must therefore no longer be operated.

This monitor is equipped with a 3-blade grounding-type plug to satisfy FCC rule. If you are unable to insert the plug into the outlet, contact your electrician.

## FCC NOTICE (U.S.A. only)

**CAUTION:** Changes or modifications not approved by JVC could void the user's authority to operate the equipment.

**NOTE:** This equipment has been tested and found to comply with the limits for a Class A digital device, pursuant to Part 15 of the FCC Rules. These limits are designed to provide reasonable protection against harmful interference when the equipment is operated in a commercial environment. This equipment generates, uses, and can radiate radio frequency energy and, if not installed and used in accordance with the instruction manual, may cause harmful interference to radio communications. Operation of this equipment in a residential area is likely to cause harmful interference in which case the user will be required to correct the interference at his own expense.

## ■ PRECAUTIONS

- Use only the power source specified on the unit. (120 V/230 V AC, 50 Hz/60 Hz)
- Keep flammable material, water, and metal objects away from the unit – especially the interior of the unit.
- This unit incorporates high voltage circuitry. For your own safety and that of your equipment, do not attempt to modify or disassemble this monitor. There are no user-serviceable parts inside.
- Video or audio signals cannot be input to this monitor without optional input cards.
- In these instructions, all explanations (except where noted) refer to the DT-V1700CG with input cards installed.

## ■ HANDLING

- Avoid shocks or vibrations. These may damage the unit and cause it to malfunction.
- Do not block the ventilation slots.
- Do not expose this unit to high temperatures. Extended exposure to direct sunlight or a heater could deform the cabinet or cause the performance of internal components to deteriorate.
- Do not place the unit near appliances generating strong electric or magnetic fields. There can generate picture noise and instability.
- Keep the monitor clean by wiping the cabinet and CRT screen with a piece of soft cloth. Do not apply thinner or benzene. These chemicals can damage the finish and erase printed letters. When the unit is excessively dirty, use a diluted neutral cleanser, then wipe away the cleanser with a dry cloth.

## SCREEN BURN

- It is not recommended to keep a certain still image displayed on screen for a long time as well as displaying extremely bright images on screen. This may cause a burning (sticking) phenomenon on the screen of cathode-ray tube. This problem does not occur as far as displaying normal video playback motion images.

## DEGAUSS

- Do not use a magnet eraser to degauss the monitor's cathode ray tube from the outside. Doing so may distort its aperture grill and cause a malfunction.

## POWER CONNECTION

The power supply voltage rating of this product is AC 120 V (For U.S.A. and Canada only) and AC 230 V (For European countries or United Kingdom), the power cord attached conforms to the following power supply voltage and countries. Use only the power cord designated to ensure Safety and EMC regulations of each country.

### Power cord

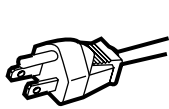

Power supply voltage : AC 120 V  
Countries : U.S.A. and Canada

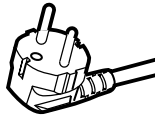

AC 230 V  
European countries

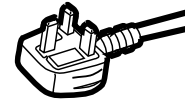

AC 230 V  
United Kingdom

### Warning:

- Do not use the same Power Cord for AC 120 V as for AC 230 V. Doing so may cause malfunction, electric shock or fire.

### Note for the United Kingdom power cord only

The plug on the United Kingdom power cord has a built-in fuse. When replacing the fuse, be sure to use only a correctly rated approved type, re-fit the fuse cover.  
(Consult your dealer or qualified service personnel.)

#### How to replace the fuse

Open the fuse compartment with the blade screw driver, and replace the fuse.

(\* An example is shown in the illustration.)

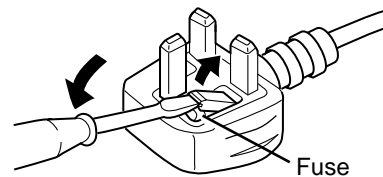

# CONTENTS

<b>SAFETY PRECAUTIONS .....</b>	<b>2</b>
<b>CONTROLS AND FEATURES .....</b>	<b>4</b>
<b>CONTROLS AND FEATURES (INPUT CARD: OPTIONAL) .....</b>	<b>6</b>
<b>PREPARATION .....</b>	<b>8</b>
<b>BASIC MENU OPERATIONS (MAIN MENU, SETUP MENU) .....</b>	<b>9</b>
<b>HOW TO USE "MAIN MENU" .....</b>	<b>10</b>
<b>HOW TO USE "SETUP MENU" .....</b>	<b>13</b>
<b>HOW TO USE EXTERNAL CONTROL .....</b>	<b>17</b>
<b>TROUBLESHOOTING .....</b>	<b>19</b>
<b>SPECIFICATIONS .....</b>	<b>21</b>

# CONTROLS AND FEATURES

## FRONT VIEW

<Front Panel>

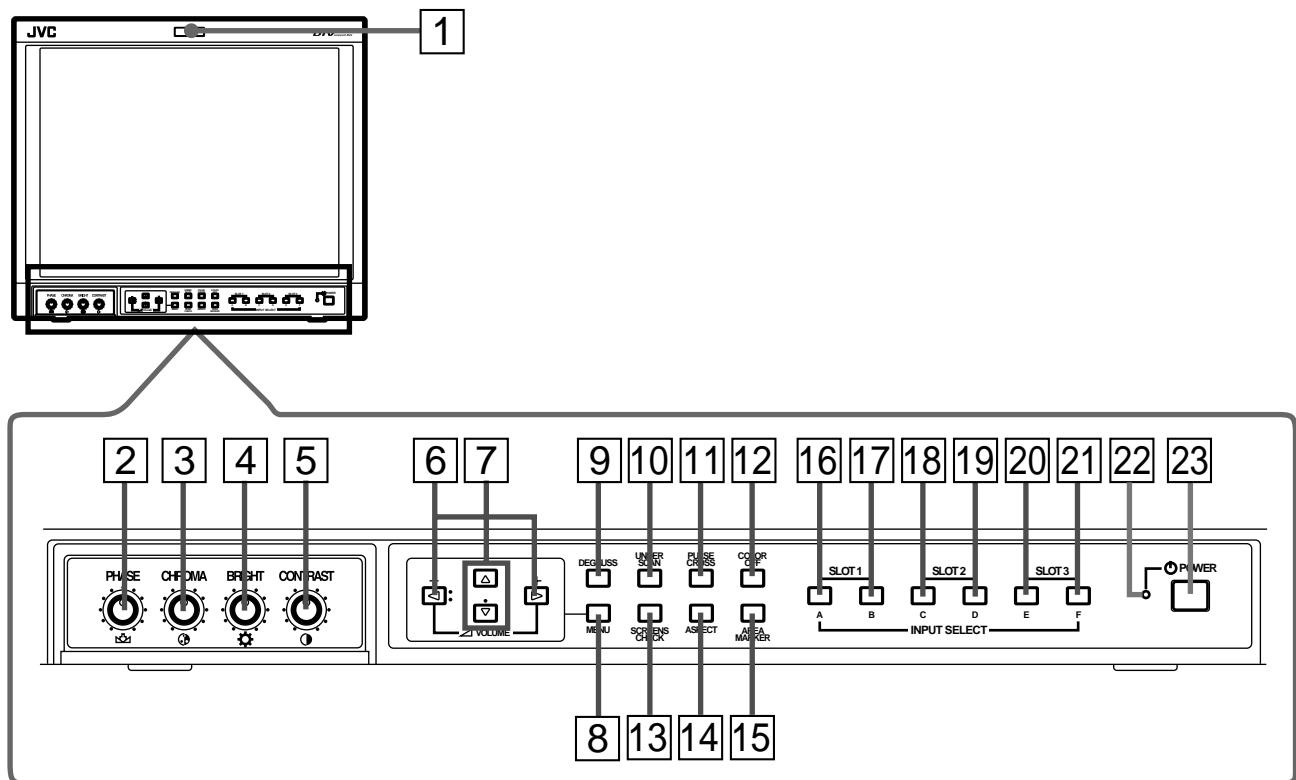

- 1 Tally lamp**  
Lights when the tally control signal is ON. The tally control signal is input through the MAKE remote terminal. For details, refer to Page 17.
- 2 PHASE adjustment knob**  
Adjusts picture hue. Turn the knob to the left to make the picture redder, and turn it to the right to make the picture greener.
- 3 CHROMA adjustment knob**  
Adjusts picture colour density. Turn the knob to the left to make the picture colour lighter, and turn it to the right to make the picture colour deeper.
- 4 BRIGHT adjustment knob**  
Adjusts picture brightness. Turn the knob to the left to make the picture darker, and turn it to the right to make the picture brighter.
- 5 CONTRAST adjustment knob**  
Adjusts picture contrast. Turn the knob to the left to make the picture contrast lower, and turn it to the right to make the picture contrast higher.
- 6 VOLUME buttons**  
Adjusts the speaker volume. Also used to set or adjust menu screen items.
- 7 Menu select buttons**  
Selects menu screen items or set-up menu screen.
- 8 MENU button**  
Displays, adjusts or closes a menu screen.
- 9 DEGAUSS button/lamp**  
Press the DEGAUSS button. The button lights and degaussing is performed automatically. When the degaussing is completed, the light goes off.
- 10 UNDER SCAN button/lamp**  
Press the UNDER SCAN button. The button lights and the screen is reduced (under-scan) and the whole screen is displayed. When the UNDER SCAN button is pressed while lit, the light goes off and the screen returns to normal size (over-scan). Use this function to check the whole screen.  
**NOTE:** This function is invalid with the RGB-input screen.
- 11 PULSE CROSS button/lamp**  
Press the PULSE CROSS button. The picture is separated into 4 parts. The synchronised signal displayed in the shape of a cross separating the parts. The screen automatically brightens to make it easier to confirm synchronised sections easy. When the PULSE CROSS button is pressed while lit, the light goes off and the normal screen is restored.  
**NOTE:** This function is invalid with the RGB-input screen.

# REAR/SIDE VIEW

## <Rear Panel>

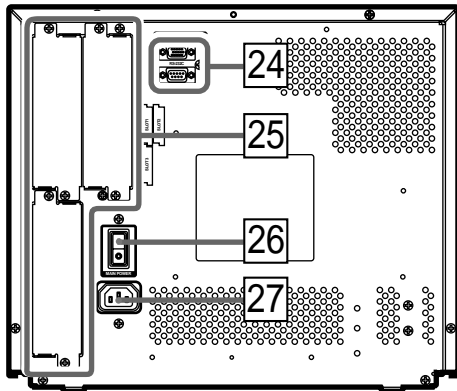

## <Side Panel>

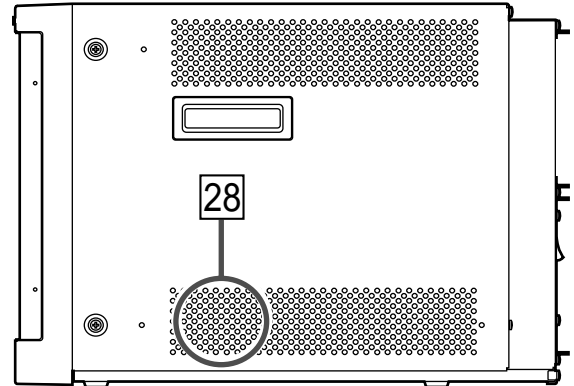

### 12 COLOR OFF button/lamp

Press the COLOR OFF button. The button lights and the screen becomes monochrome. When the COLOR OFF button is pressed while lit, the light goes off and the normal screen is restored.

Use this function to confirm the noise in the brightness signal or to confirm the white balance.

**NOTE:** This function is invalid with the RGB-input screen.

### 13 SCREENS CHECK button/lamp

Press the SCREENS CHECK button. The button lights and the screen changes in the following order:

Normal screen → Red screen → Green screen → Blue screen → Normal screen

Press the SCREENS CHECK button when the blue screen is displayed. The light goes off and the normal screen is restored.

Use this function to confirm or adjust CHROMA or PHASE.

**NOTE:** This function is invalid with the RGB-input screen.

### 14 ASPECT button/lamp

When the ASPECT button is pressed while the screen ratio is 4:3, the button lights and the screen ratio changes to 16:9. When the ASPECT button is pressed while lit, the light goes off and the normal screen is restored.

**NOTE:** This function is invalid with the RGB-input screen.

### 15 AREA MARKER button/lamp

When the AREA MARKER button is pressed while the screen ratio is 16:9, the button lights and the white marker is displayed. This shows the screen size (area) set on the menu. When the AREA MARKER button is pressed while lit, the light goes off and the normal screen is restored.

**NOTE:** This function is invalid with the RGB-input screen.

### 16 – 21 INPUT SELECT buttons/lamps

Press the unlit button. The button lights and the input signal is changed. (any other lit button goes off.) When the lit button is pressed, the status of the current input signal is displayed (for approx. 3 seconds). Buttons A through F correspond to the signals input via the input cards installed in SLOT 1 through SLOT 3.

A, B : select the picture from the SLOT 1 input card.  
C, D : select the picture from the SLOT 2 input card.  
E, F : select the picture from the SLOT 3 input card.

Refer to pages 8 and 9 for correspondence between the input terminals and the INPUT SELECT buttons.

### 22 Power lamp

Unlit : The main power is OFF.

Orange : The main power is ON, but the monitor's power is OFF (in stand-by mode).

Green : The main power is ON, and the monitor's power is ON (in normal operation mode).

### 23 POWER switch

Press the power switch to turn the monitor's power ON or OFF when the main power is ON.

**NOTE:** When RUSH DELAY TIME is set to MODE 2 in the set-up menu, it takes approx. 3.2 seconds for the power to actually turn ON after the power switch is pressed.

### 24 REMOTE (external control) terminals

Terminals for controlling the monitor from an external unit. RS-232C terminal (Upper):

Enables the monitor to be controlled from a personal computer via serial communication.

MAKE terminal (Lower):

Enables the monitor to be controlled by closing the circuit (point of contact) connected to the terminal.

### 25 Input card slots (SLOT 1 — SLOT 3)

Optional input cards can be installed in these slots. Input cards are not provided when you purchase the monitor.

**NOTE:** It is not possible to input video or audio signals to the monitor when no input cards are installed.

### 26 Main power switch

Press the switch to turn the main power ON or OFF.

When the main power is ON, the power lamp on the front panel lights in yellow and the monitor enters the stand-by mode.

I : ON    O : OFF

### 27 AC inlet

Power input connector. Connect the provided AC power cord to an AC outlet (120 V/230 V AC, 50 Hz/60 Hz).

### 28 Built-in speaker (monaural)

Outputs the input audio.

# CONTROLS AND FEATURES

## (INPUT CARD: OPTIONAL)

### COMPONENT/RGB INPUT CARD (OPTIONAL: IF-C01COMG)

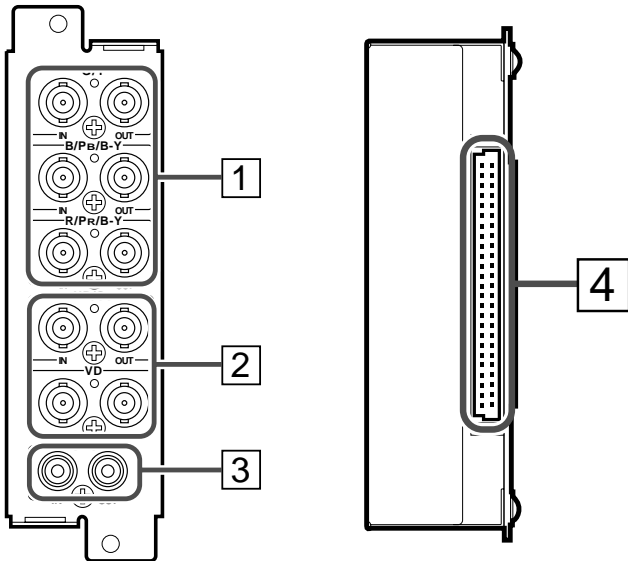

Compatible signal formats:  
480/60i, 576/50i, 480/50p, 480/60p, 720/60p, 1035/60i,  
1080/50i, 1080/60i

- 1 Video input/output terminals**  
Input (IN) and output (OUT) terminals for component (colour deference) or RGB signals. The IN and OUT terminals are bridge-connected. (When no cable is connected to the OUT terminal, the input signal is automatically terminated.)  
Select component signal : press INPUT SELECT A/C/E button  
Select RGB signal : press INPUT SELECT B/D/F button
- 2 Synchronised signal input/output terminals**  
Input (IN) and output (OUT) terminals for the vertical, horizontal or complex synchronised signals. The synchronised signals from these terminals have priority over other terminals. When no synchronised signal is input to these terminals, the synchronised signal from the video input/output terminals (G/Y terminals) is valid. The IN and OUT terminals are bridge-connected. (When no cable is connected to the OUT terminal, the input signal is automatically terminated.)
- 3 Audio input/output terminals**  
Input (IN) and output (OUT) terminals for audio signals. The IN and OUT terminals are bridge-connected.
- 4 Connection terminal (to a Multi-Format Monitor)**  
Attach to the connection terminal of your multi-format monitor.

### VIDEO INPUT CARD (OPTIONAL: IF-C01PNG)

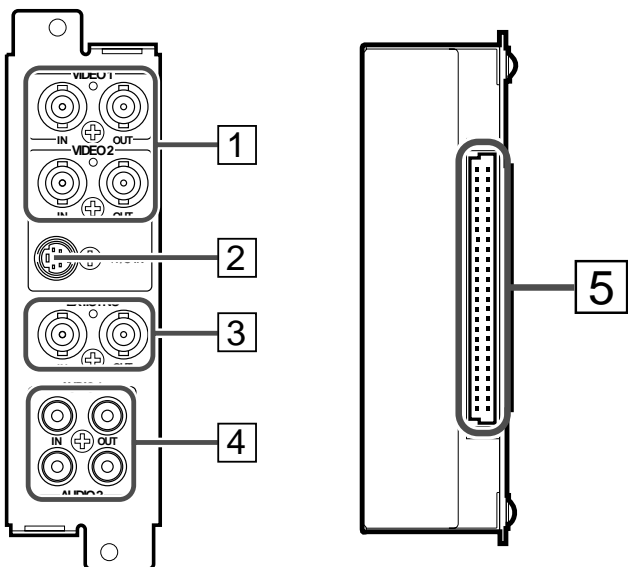

Compatible signal formats:  
NTSC (3.58 MHz), PAL (4.43 MHz), black-and-white (50 Hz/60 Hz)  
\* You can select "AUTO" (automatic selection), "NTSC" or "PAL" in SETUP MENU when switching NTSC or PAL. Normally select AUTO. However, if the input signal is unstable, select NTSC or PAL.

- 1 Video input/output terminals**  
Input (IN) and output (OUT) terminals for video signals. The IN and OUT terminals are bridge-connected. (When no cable is connected to the OUT terminal, the input signal is automatically terminated.)  
Select VIDEO 1 : press INPUT SELECT A/C/E button  
Select VIDEO 2 : press INPUT SELECT B/D/F button
- 2 S-video input terminal**  
Input terminal for the S-video signal. When an S-video signal is input to this terminal and a video signal is input to VIDEO 2, the S-video signal has priority over the video signal. When choosing the S-video input, press INPUT SELECT B/D/F button.
- 3 Synchronised signal input/output terminals**  
Input (IN) and output (OUT) terminals for the complex synchronised signals. The synchronised signals from these terminals have priority over signals from other terminals. When no synchronised signal is input to these terminals, the synchronised signal from the video input/output terminals is valid. The IN and OUT terminals are bridge-connected. (When no cable is connected to the OUT terminal, the input signal is automatically terminated.)
- 4 Audio input/output terminals**  
Input (IN) and output (OUT) terminals for audio signals corresponding to VIDEO 1 and VIDEO 2. The IN and OUT terminals are bridge-connected.
- 5 Connection terminal (to a Multi-Format Monitor)**  
Attach to the connection terminal of your multi-format monitor.

## SDI INPUT CARD (OPTIONAL: IF-C01SDG)

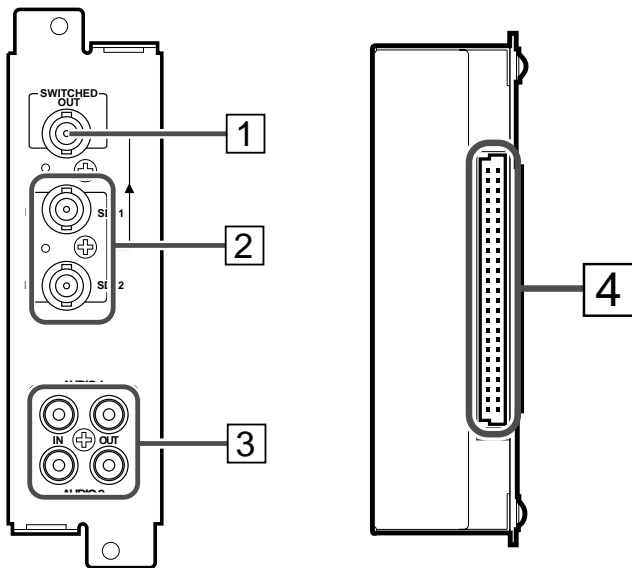

### 1 Output terminal for a selected component serial digital signal

Output terminal for a selected digital signal (the input displayed on the screen). The output signal is cable-compensated.

**NOTE:** When the monitor's power is OFF, no digital signal is output.

### 2 Input terminals for component serial digital signals

Input terminals for the digital signal.

Select SDI 1 : press INPUT SELECT A/C/E button

Select SDI 2 : press INPUT SELECT B/D/F button

### 3 Audio input/output terminals

Input (IN) and output (OUT) terminals for the analogue signals corresponding to SDI 1 and SDI 2.

**NOTE:** This input card cannot decode audio data even if contained in the input digital signal.

### 4 Connection terminal (to a Multi-Format Monitor)

Attach to the connection terminal of your multi-format monitor.

Compatible signal formats: 480/60i, 480/50i

## HD SDI INPUT CARD (OPTIONAL: IF-C01HSDG)

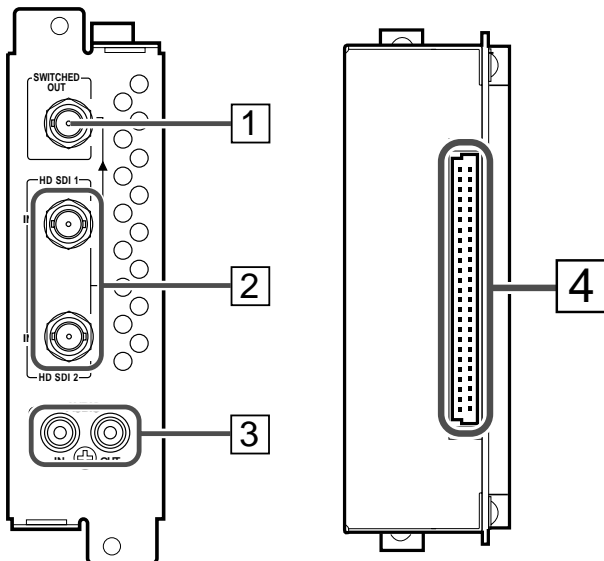

### 1 Output terminal for a selected component serial digital signal

Output terminal for a selected digital signal (the input displayed on the screen). The output signal is cable-compensated.

**NOTE:** When the monitor's power is OFF, no digital signal is output.

### 2 Input terminals for component serial digital signals

Input terminals for the digital signal.

Select HD SDI 1 : press INPUT SELECT A/C/E button

Select HD SDI 2 : press INPUT SELECT B/D/F button

### 3 Audio input/output terminals

Input (IN) and output (OUT) terminals for the analogue audio signals.

**NOTE:** This input card cannot decode audio data even if contained in the input digital signal.

### 4 Connection terminal (to a Multi-Format Monitor)

Attach to the connection terminal of your multi-format monitor.

Compatible signal formats: 720/60p, 1035/60i, 1080/50i, 1080/60i, 1080/24pSF

# PREPARATION

## INSTALLING THE INPUT CARD

Optional input cards are necessary to use the functions of this monitor. Before mounting the monitor or connecting other equipment to the monitor, be sure to install the input cards.

1. Turn off the Multi-Format Monitor's main power and unplug the power cable from the AC outlet.
2. Unscrew the screws and remove the slot cover from the slot (on the rear side of the monitor) in which you are going to install the card.

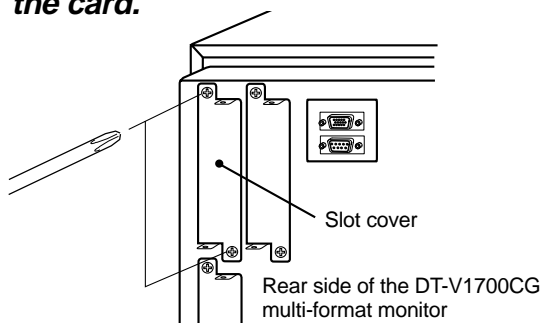

3. Insert the Input Card's board (green-coloured) into the slot, fitting the board into the guide rails on the top and bottom of the slot.

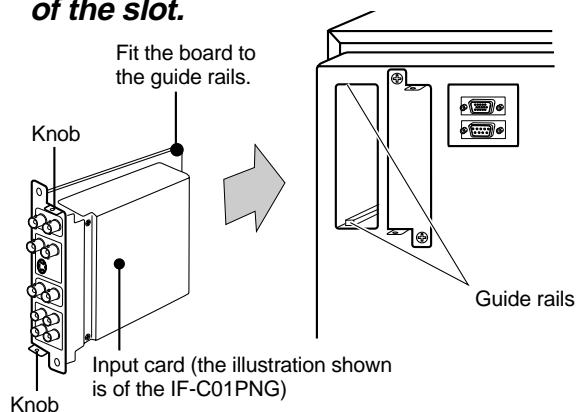

4. Push the Input Card in so that its front panel touches the monitor's rear panel.
5. Secure the Input Card by replacing the screws removed in Procedure 2.

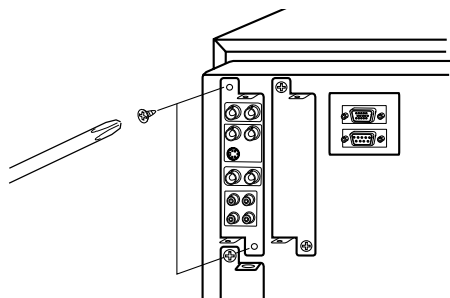

**NOTE :** Do not touch the terminal connected to the monitor or board pattern.  
Do not remove slot covers from the monitor's slots if they are not in use.

## ATTACHING THE WIDE MASK

A wide mask is provided with the monitor. This changes the viewable screen area to the 16:9 aspect ratio.

The wide mask cannot be attached to the monitor after the monitor is mounted in a rack. Mount the wide mask before installing the monitor in a rack.

1. Prepare the provided wide mask and 4 screws (for attaching).
2. Attach the wide mask to the monitor.

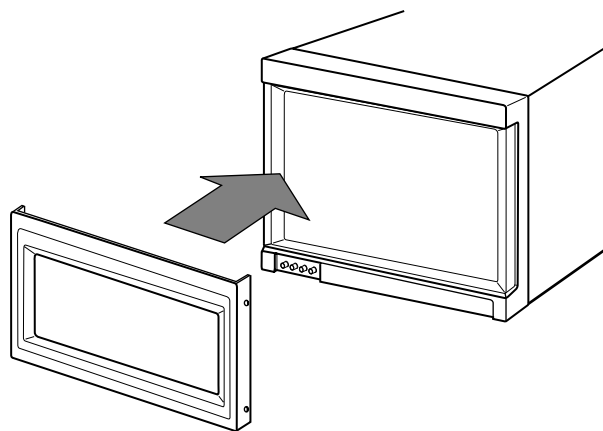

3. Secure the wide mask with the screws (fix 2 screws each to both right and left side).

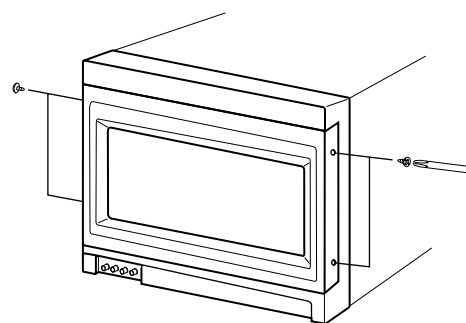

- When detaching the wide mask, follow this procedure in reverse.



# BASIC MENU OPERATIONS

## (MAIN MENU, SETUP MENU)

### ABOUT MENU SCREENS

This monitor features a MAIN MENU (main menu screen) and a SETUP MENU (setup menu screen).

The MAIN MENU contains the functions normally used, and the SETUP MENU contains the settings required for initial setup.

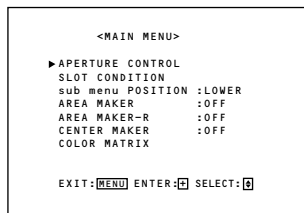

MAIN MENU (main menu screen)

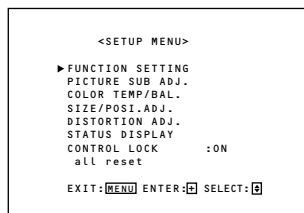

SETUP MENU (setup menu screen)

**NOTE :** The contents of menus vary depending on the input signal or combination of the monitor's settings.

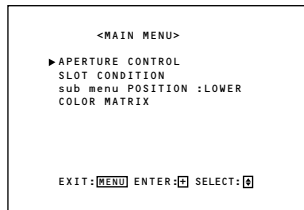

MAIN MENU when the 4:3 video signal is input

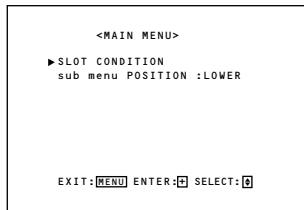

MAIN MENU when the RGB signal is input

### DISPLAYING THE MENU SCREENS

#### To display MAIN MENU

Press the button on the front panel.

#### To display SETUP MENU

Press the button while pressing the button on the front panel.

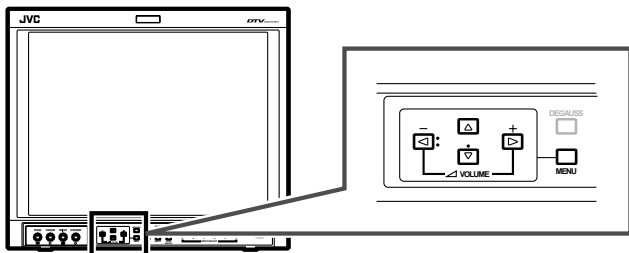

### CLOSING THE MENU SCREENS

#### Using the MENU button

Press the button a few times until the Menu Screen disappears.

#### With no operation

When approx. 30 seconds have passed since the last Menu operation, both screens will disappear.

\* Some items on the Menu Screens disappear automatically after setting.

### BASIC MENU OPERATION

#### To select an item,

Press the or buttons to move the cursor (▶) on the Menu Screens and select the desired item.

#### To set (select) or adjust an item,

Press the or buttons to select or adjust the desired item.

#### When the desired item has other menus (hierarchical menus),

Press the button to display the lower hierarchical menu.

#### To return to the former Menu Screen,

Press the button.

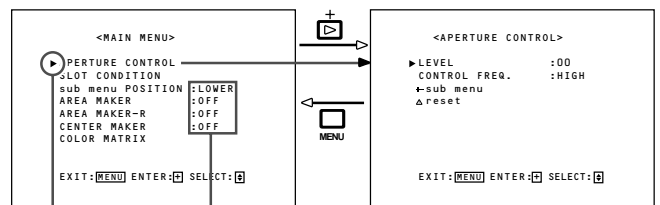

Cursor  
Move (select) with the or buttons.

### HOW TO USE THE SUB MENU

The sub menu function applies to Menu Screen items that should be adjusted or set while watching the picture. This function simplifies the adjustment or setting while watching the picture by displaying the single item on the top or bottom of the screen.

#### To use the sub menu function,

Press the or buttons to select “+ sub menu”. Then, press the button to display the sub menu screen.

#### To adjust or set an item in the sub menu screen,

Press the or buttons.

#### To change the item to be adjusted or set,

Press the or buttons.

#### To change the position of the sub menu screen,

Set “UPPER” (on the top) or “LOWER” (on the bottom) in “sub menu POSITION” of MAIN MENU.

#### To close the sub menu screen,

Press the button. The previous Menu Screen is displayed.

Example of sub menu screen

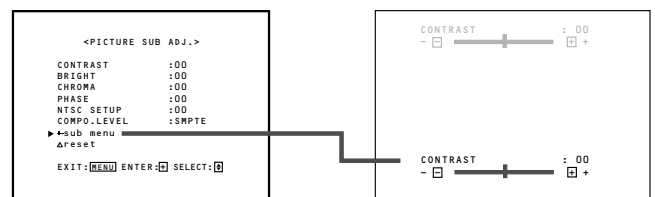

The upper pale screen; when setting “UPPER” in “sub menu POSITION”  
The lower dark screen; when setting “LOWER” in “sub menu POSITION”

# HOW TO USE "MAIN MENU"

## "MAIN MENU" ITEMS

The following items appear in MAIN MENU.

Items	Functions	Displays
1 APERTURE CONTROL	Compensates the frequency characteristics of the input video signal.	*1
2 SLOT CONDITION	Displays the status of the input cards installed in each of the input card slots.	
3 sub menu POSITION	Selects the display position of the sub menu superimposed on the screen.	
4 AREA MARKER	Selects the size marker for the other screen ratio used when the screen ratio is 16:9.	*2
5 AREA MARKER-R	Selects the size marker for the other screen ratio used when the screen ratio is 16:9. (for external control)	*2
6 CENTER MARKER	Makes the centre marker appear or disappear.	*2
7 COLOR MATRIX	Selects or adjusts the picture colour matrix.	*1

About "Displays" \*1: Not displayed when an RGB signal is input.

\*2: Displayed only when the screen ratio is 16:9. Not displayed when an RGB signal is input.

When some items are not displayed depending on the input signals, subsequent items will move up.

## "MAIN MENU" SCREENS

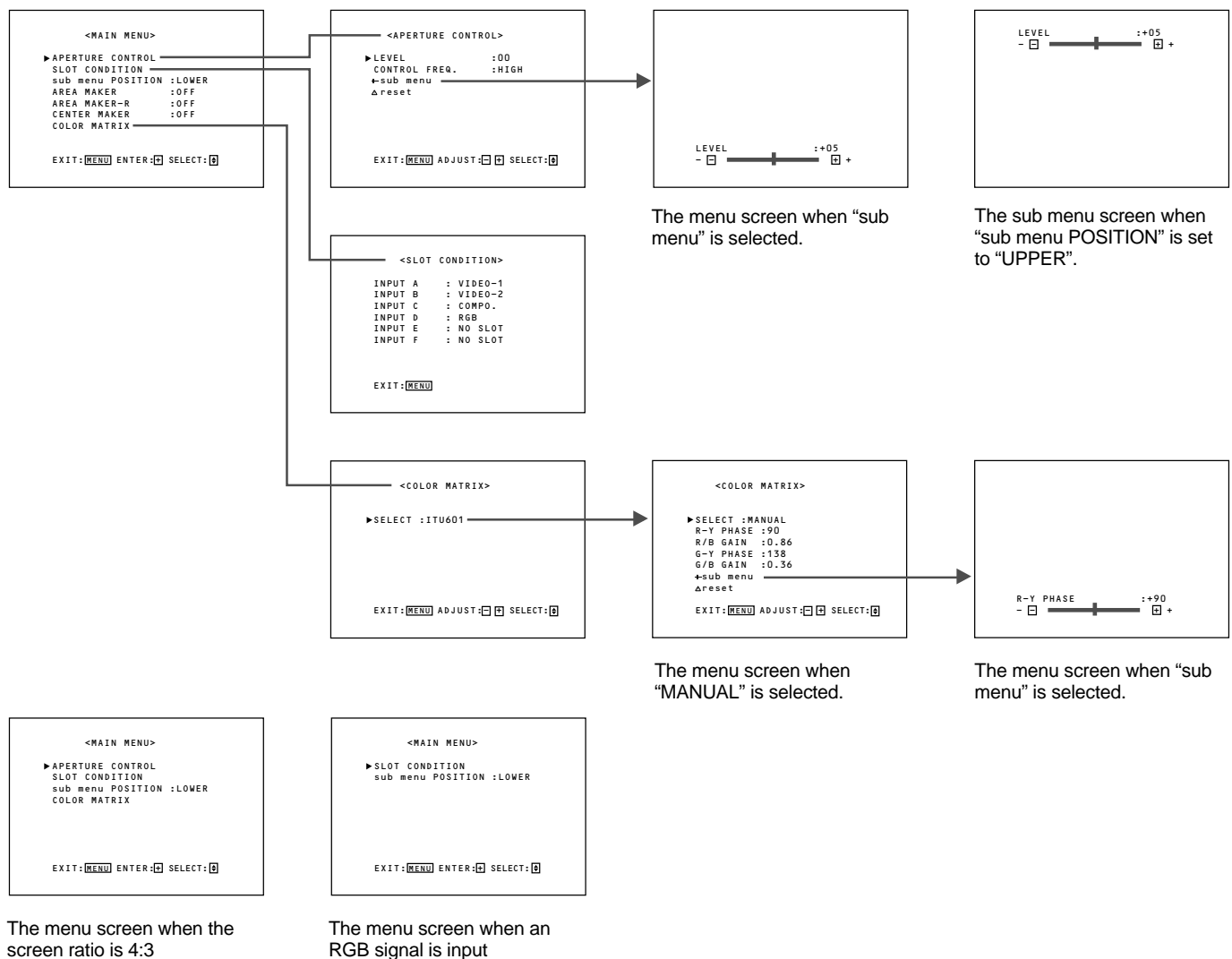

# ITEM CONTENTS AND ADJUSTMENT RANGE/SETTINGS

## 1. APERTURE CONTROL

Compensates the frequency characteristics of the input video signal. Press the  button to display the setting menu illustrated on the right.

**NOTE :** APERTURE CONTROL is not displayed when the RGB signal is input.

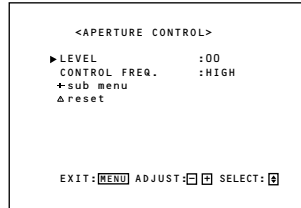

---

Item : LEVEL  
 Adjustment range : 00 ~ +10  
 Function : Adjusts the compensate value. The higher the number is, the larger the compensate value gets.

---

Item : CONTROL FREQ.  
 Settings : HIGH/LOW/OFF  
 Function : Adjusts the frequency compensation.  
 HIGH : Compensates the high frequencies.  
 LOW : Compensates the low frequencies.  
 OFF : Deactivates the aperture compensation.

---

Item : sub menu  
 Adjustment range/  
 Settings : Same as LEVEL or CONTROL FREQ.  
 Function : Performs the LEVEL or CONTROL FREQ. settings in a single-line display. The display position depends on the "sub menu POSITION" setting.

---

Item : reset  
 Function : Sets the LEVEL and CONTROL FREQ. values to factory-preset ones.

---

## 2. SLOT CONDITION

Displays the status of the input cards installed in each of the input card slots. Press the  button to display the setting menu illustrated on the right.

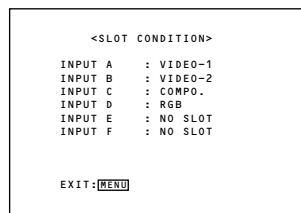

---

Items : INPUT A:/INPUT B:/INPUT C:/INPUT D:/INPUT E:/INPUT F:  
 Settings : VIDEO-1/VIDEO-2/COMPO./RGB/SDI 1/SDI 2/HD SDI 1/HD SDI 2/NO SLOT  
 Function : Displays the status of the input cards installed in each of the input card slots.

---

- INPUT A/B corresponds to SLOT 1, INPUT C/D to SLOT 2, and INPUT E/F to SLOT 3.
- VIDEO-1 or VIDEO-2 shows the video input card is installed. COMPO. or RGB shows the component/RGB input card. SDI 1 or SDI 2 shows the SDI input card is installed. HD SDI 1 or HD SDI 2 shows the HD SDI input card is installed.
- NO SLOT shows no input cards are installed.

## 3. sub menu POSITION

Items : Selects the display position of the sub menu superimposed on the screen.  
 Settings : UPPER/LOWER  
 Functions : UPPER : An adjustment item is displayed on the top of the screen.  
 LOWER : An adjustment item is displayed on the bottom of the screen.

## 4. AREA MARKER

Items : Selects the size marker for the other screen ratio (aspect) used when the screen ratio is 16:9.  
 Settings : OFF/4:3/16:9/14:9/13:9/MODE 1/MODE 2  
 Functions : OFF: The marker is not displayed.  
 4:3/16:9/14:9/13:9: Displays the marker (a white quadrangle) showing the screen size of each aspect ratio.  
 MODE 1/MODE 2: Displays no markers because these settings will be used for function expansion in the future.

- AREA MARKER is displayed when a 16:9 picture such as 1080i/1035i/720p etc. is displayed or the picture is switched to the 16:9 screen ratio by pressing the ASPECT button.
- To actually display the marker, **the AREA MARKER button on the monitor needs to be pressed so that it is illuminated.**

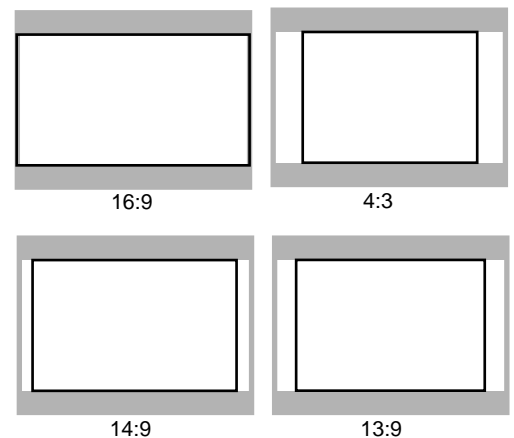

## 5. AREA MARKER-R

Items : Selects the size marker for the other screen ratio (aspect) used when the screen ratio is 16:9. (for external control)

Settings : OFF/4:3/16:9/14:9/13:9/MODE 1/MODE 2

Functions : OFF: The marker is not displayed.  
 4:3/16:9/14:9/13:9: Displays the marker (a white quadrangle) showing the screen size of each aspect ratio.  
 MODE 1/MODE 2: Displays no markers because these settings will be used for function expansion in the future.

- AREA MARKER-R is displayed when a 16:9 picture such as 1080i/1035i/720p etc. is displayed or the picture is switched to the 16:9 screen ratio by pressing the ASPECT button.
- The marker is actually displayed when the external control selects each setting. (No markers are displayed even if each marker is selected only in the monitor's AREA MARKER-R setting.)

## 6. CENTER MARKER

Items : Makes the centre marker appear or disappear.

Settings : ON/OFF

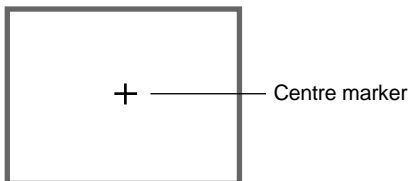

Functions : ON : The centre marker (a white cross) is displayed on the centre of the screen.  
 OFF : The marker disappears.

- To actually display the marker, **the AREA MARKER button on the monitor needs to be pressed so that it is illuminated.**



## 7. COLOR MATRIX

Selects or adjusts the standard of the colour demodulation (colour rendering). Press the  button to display the setting menu illustrated on the right.

<COLOR MATRIX>	
▶SELECT	: MANUAL
R-Y PHASE	: 90
R/B GAIN	: 0.86
G-Y PHASE	: 244
G/B GAIN	: 0.30
*sub menu	
Δreset	
EXIT: 	ADJUST: 
	SELECT: 

The menu screen when **MANUAL** is selected.

- The standard setting is set to "ITU601" or "ITU709" depending on the input signal format.  
 The factory preset of MANUAL is ITU709

Input Signal Format	Standard setting	Manual setting (MANUAL)
NTSC, PAL, 480/60i, 480/60p, 576/50i, 575/50p	ITU601	ITU709
720/60p, 1080/50i, 1080/60i, 1035/60i, 1080/24pSF	ITU709	

ITU601	R-Y PHASE	90
	R/B GAIN	0.79
	G-Y PHASE	244
ITU709	G/B GAIN	0.45
	R-Y PHASE	90
	R/B GAIN	0.86
	G-Y PHASE	244
	G/B GAIN	0.30

Item : SELECT

Function : Selects the picture matrix standard.

Settings : ITU601 or ITU709/ MANUAL  
 ITU601 or ITU709 : Standard setting  
 MANUAL : Manual setting

**NOTE** : The following items are displayed when MANUAL is selected. When ITU601 or ITU709 is selected, they are not displayed.

Item : R-Y PHASE

Function : Sets the R-Y phase.

Settings : 90/92/94/112

Item : R/B GAIN

Function : Sets the R/B gain.

Settings : 0.86/0.56/0.68/0.79

Item : G-Y PHASE

Function : Sets the G-Y phase.

Settings : 244/253/236/240

Item : G/B GAIN

Function : Sets the G/B gain.

Settings : 0.30/0.34/0.40/0.45

Item : sub menu

Function : Performs the R-Y PHASE, R/B GAIN, G-Y PHASE or G/B GAIN settings in a single-line display. The display position depends on the "sub menu POSITION" setting.

Settings : Same as R-Y PHASE, R/B GAIN, G-Y PHASE or G/B GAIN

Item : reset

Function : Sets the R-Y PHASE, R/B GAIN, G-Y PHASE and G/B GAIN values to factory-preset ones.

# HOW TO USE "SETUP MENU"

## "SETUP MENU" ITEMS

Items	Functions
1 FUNCTION SETTING	Displays the monitor's power-up time or the total usage time.
2 PICTURE SUB ADJ.	Performs approximate adjustments using the control knobs on the front panel.
3 COLOR TEMP./BAL.	Sets or adjusts the colour temperature or white balance.
4 SIZE/POSI. ADJ.	Adjusts the size or position of the picture.
5 DISTORTION ADJ.	Compensates the picture distortion.
6 STATUS DISPLAY	Makes the status of the input signal appear or disappear on the screen.
7 CONTROL LOCK	Sets the control lock preventing the monitor from misuse.
8 all reset	Sets all items in SETUP MENU to factory-preset values.

## "SETUP MENU" SCREENS

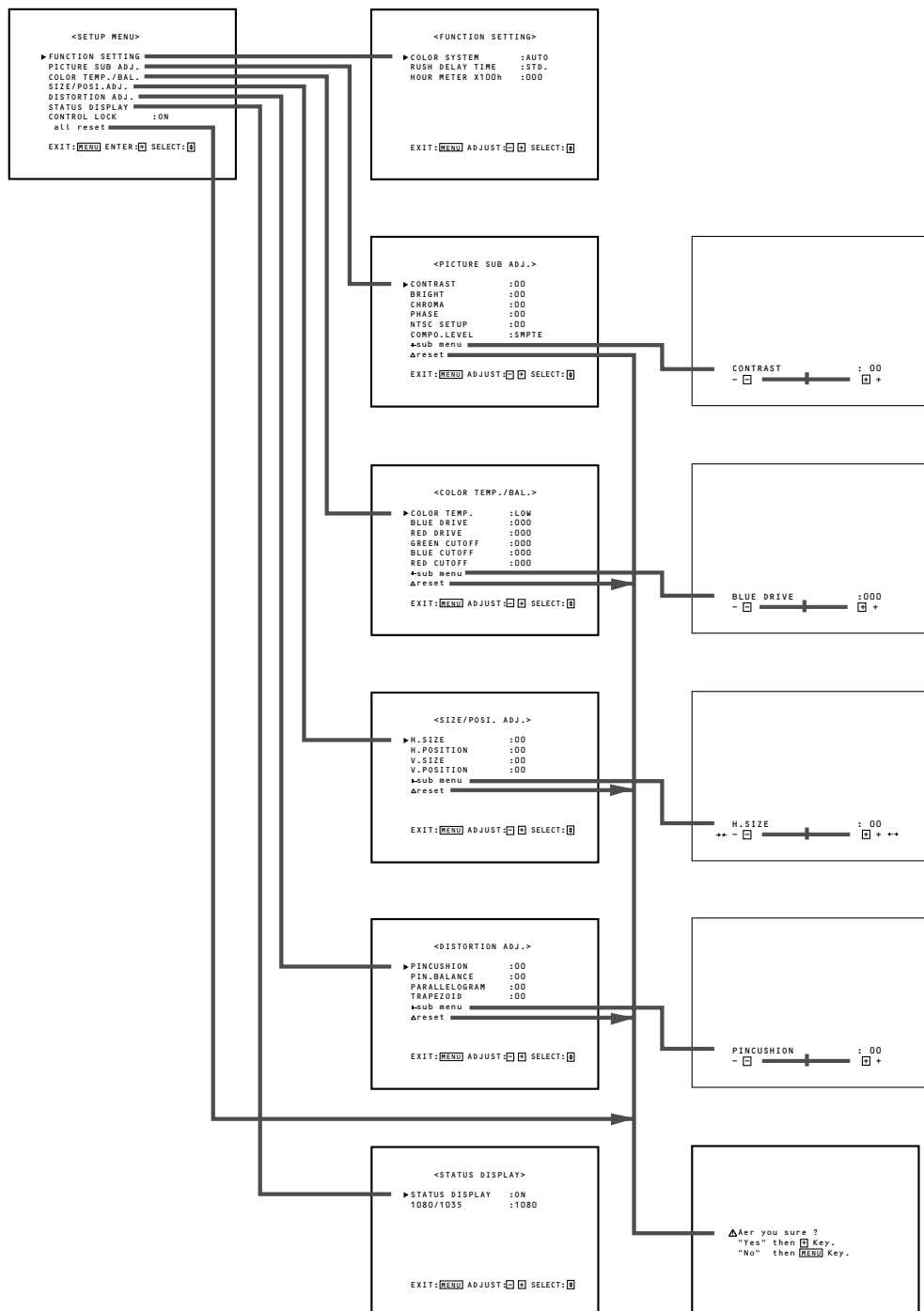

# HOW TO USE "SETUP MENU" (cont'd)

## ITEM CONTENTS AND ADJUSTMENT RANGE/SETTINGS

### 1. FUNCTION SETTING

Selects the colour system and displays the monitor's power-up time or the total usage time. Press the  button to display the setting menu illustrated on the right.

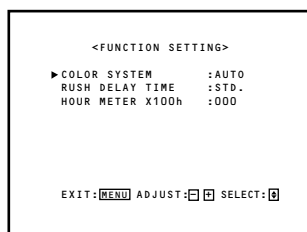

---

Item : COLOR SYSTEM  
 Settings : AUTO/NTSC/PAL  
 Function : Selects the colour system when using the video input card.  
 AUTO : Change NTSC and PAL automatically.  
 NTSC : Keeps the colour system NTSC.  
 PAL : Keeps the colour system PAL.

**NOTE** : Normally select AUTO. However, if the input signal is unstable, select NTSC or PAL.

---

Item : RUSH DELAY TIME  
 Settings : STD./SLOW  
 Function : Sets the time when the power supply to the monitor's circuits (excluding the micro computers) starts after the power switch is pressed.  
 STD. : The power supply starts approx. 1 second after the power switch is pressed.  
 SLOW : The power supply starts approx. 3.2 seconds after the power switch is pressed.

**NOTE** : When turning on many multi-format monitors simultaneously, it is recommended to use SLOW to control rush current.

---

Item : HOUR METER X100h  
 Number range : 000 ~ 655  
 Function : Displays the total usage time of the monitor in hundred-hour units.

- When the timer passes 655, it returns to 000.
- The timer does not count the usage time under one hour.

### 2. PICTURE SUB ADJ.

Performs approximate adjustments using the control knobs on the front panel. Press the  button to display the setting menu illustrated on the right.

**NOTE** : When the RGB signal is input, only CONTRAST and BRIGHT are displayed. When the PAL signal is input, only CONTRAST, BRIGHT and CHROMA are displayed.

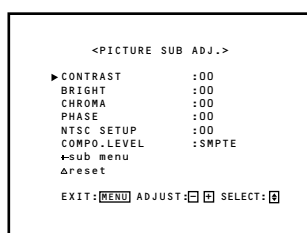

---

Item : CONTRAST  
 Adjustment range : -20 ~ 00 ~ +20  
 Function : For approximate adjustment of the picture contrast. Before adjustment, set the CONTRAST knob on the front panel to 0.

---

Item : BRIGHT  
 Adjustment range : -20 ~ 00 ~ +20  
 Function : For approximate adjustment of the picture brightness. Before adjustment, set the BRIGHT knob on the front panel to 0.

---

Item : CHROMA  
 Adjustment range : -20 ~ 00 ~ +20  
 Function : For approximate adjustment of the colour density. Before adjustment, set the CHROMA knob on the front panel to 0.

---

Item : PHASE  
 Adjustment range : -20 ~ 00 ~ +20  
 Function : For approximate adjustment of the picture hue. Before adjustment, set the PHASE knob on the front panel to 0.

---

Item : NTSC SETUP  
 Settings : 00/7.5  
 Function : Sets the level of the input NTSC signal.  
 00 : Compliant with 0% set-up signal.  
 7.5 : Compliant with 7.5% set-up signal.  
**NOTE** : NTSC SETUP is displayed only when the video input card is installed and an NTSC signal is input.

---

Item : COMPO. LEVEL  
 Settings : SMPTE/B75/B00  
 Function : Sets the level of the input component signal.  
 SMPTE : Compliant with M2VTR signals.  
 B75 : Compliant with Betacam 7.5% set-up signal.  
 B00 : Compliant with Betacam 0% set-up signal.

**NOTE** : COMPO. LEVEL is displayed only when a 480/60i, 480/60p, 576/50i or 576/50p signal is input.

---

Item : sub menu  
 Adjustment range/ Settings : Same as CONTRAST, BRIGHT, CHROMA, PHASE and COMPO. LEVEL/NTSC SETUP.  
 Function : Performs CONTRAST, BRIGHT, CHROMA, PHASE or COMPO. LEVEL/NTSC SETUP settings in a single-line display. The sub menu display varies depending on the selected item.

---

Item : reset  
 Function : Sets the CONTRAST, BRIGHT, CHROMA, PHASE and COMPO. LEVEL/NTSC SETUP values to factory-preset ones.

### 3. COLOR TEMP./BAL.

Sets or adjusts the colour temperature or white balance. Press the  button to display the setting menu illustrated on the right.

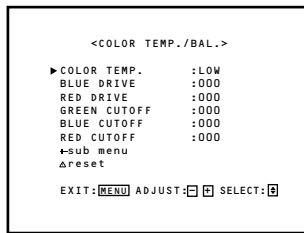

---

Item : COLOR TEMP.  
 Settings : HIGH/LOW  
 Function : Selects the colour temperature.  
           HIGH : Sets the colour temperature to D9300.  
           LOW : Sets the colour temperature to D6500.

---

Item : BLUE DRIVE  
 Adjustment  
 range : MIN ~ 000 ~ MAX (in 127 grades)  
 Function : Adjusts the blue drive level.

---

Item : RED DRIVE  
 Adjustment  
 range : MIN ~ 000 ~ MAX (in 127 grades)  
 Function : Adjusts the red drive level.

---

Item : GREEN CUTOFF  
 Adjustment  
 range : MIN ~ 000 ~ MAX (in 255 grades)  
 Function : Sets the green cut-off point.

---

Item : BLUE CUTOFF  
 Adjustment  
 range : MIN ~ 000 ~ MAX (in 255 grades)  
 Function : Sets the blue cut-off point.

---

Item : RED CUTOFF  
 Adjustment  
 range : MIN ~ 000 ~ MAX (in 255 grades)  
 Function : Sets the red cut-off point.

---

Item : sub menu  
 Adjustment range/  
 Settings : Same as BLUE DRIVE, RED DRIVE, GREEN CUTOFF, BLUE CUTOFF and RED CUTOFF.  
 Function : Performs BLUE DRIVE, RED DRIVE, GREEN CUTOFF, BLUE CUTOFF or RED CUTOFF settings in a single-line display. The sub menu display varies depending on the selected item.

---

Item : reset  
 Function : Sets the BLUE DRIVE, RED DRIVE, GREEN CUTOFF, BLUE CUTOFF and RED CUTOFF values to factory-preset ones.

---

### 4. SIZE/POSI. ADJ.

Adjusts the size or position of the picture. Press the  button to display the setting menu illustrated on the right.

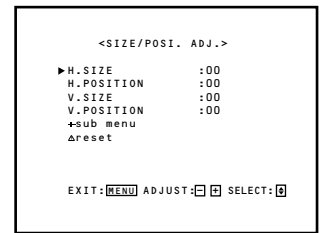

---

Item : H.SIZE  
 Adjustment  
 range : -20 ~ 00 ~ +20  
 Function : Adjusts the horizontal screen size.  
           - : Reduces the screen size horizontally.  
           + : Enlarges the screen size horizontally.

---

Item : H.POSITION  
 Adjustment  
 range : -20 ~ 00 ~ +20  
 Function : Adjusts the horizontal screen position.  
           - : Move the screen to the left.  
           + : Move the screen to the right.

---

Item : V.SIZE  
 Adjustment  
 range : -20 ~ 00 ~ +20  
 Function : Adjusts the vertical screen size.  
           - : Reduces the screen size vertically.  
           + : Enlarges the screen size vertically.

---

Item : V.POSITION  
 Adjustment  
 range : -20 ~ 00 ~ +20  
 Function : Adjusts the vertical screen position.  
           - : Move the screen up.  
           + : Move the screen down.

---

Item : sub menu  
 Adjustment range/  
 Settings : Same as H.SIZE, H.POSITION, V.SIZE and V.POSITION.  
 Function : Performs H.SIZE, H.POSITION, V.SIZE or V.POSITION settings in a single-line display. The sub menu display varies depending on the selected item.

---

Item : reset  
 Function : Sets the H.SIZE, H.POSITION, V.SIZE and V.POSITION values to factory-preset ones.

---

## 5. DISTORTION ADJ.

Compensates the picture distortion. Press the  button to display the setting menu illustrated on the right.

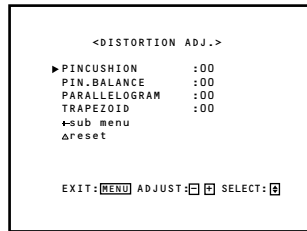

---

Item : PINCUSHION  
 Adjustment range : -20 ~ 00 ~ +20  
 Function : Compensates pincushion picture distortion.  
 - : Expands both left and right sides of the picture.  
 + : Squeezes both left and right sides of the picture.

---

Item : PIN.BALANCE  
 Adjustment range : -20 ~ 00 ~ +20  
 Function : Adjusts the compensation balance of the pincushion picture distortion.  
 - : The picture is expanded on the left side, and squeezed on the right side.  
 + : The picture is squeezed on the left side, and expanded on the right side.

---

Item : PARALLELOGRAM  
 Adjustment range : -20 ~ 00 ~ +20  
 Function : Compensates parallelogram picture distortion.  
 - : Moves the upper side of the picture to the right, and the lower side to the left.  
 + : Moves the upper side of the picture to the left, and the lower side to the right.

---

Item : TRAPEZOID  
 Adjustment range : -20 ~ 00 ~ +20  
 Function : Compensates trapezoid picture distortion.  
 - : Enlarges the upper side of the picture.  
 + : Reduces the upper side of the picture.

---

Item : sub menu  
 Adjustment range/  
 Settings : Same as PINCUSHION, PIN.BALANCE, PARALLELOGRAM and TRAPEZOID.  
 Function : Performs PINCUSHION, PIN.BALANCE, PARALLELOGRAM or TRAPEZOID settings in a single-line display. The sub menu display varies depending on the selected item.

---

Item : reset  
 Function : Sets the PINCUSHION, PIN.BALANCE, PARALLELOGRAM and TRAPEZOID values to factory-preset ones.

---

## 6. STATUS DISPLAY

Makes the status of the input signal appear or disappear on the screen. Press the  button to display the setting menu illustrated on the right.

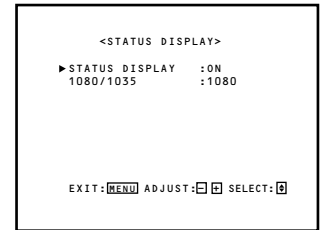

---

Item : STATUS DISPLAY  
 Settings : ON/OFF  
 Function : Makes the format name appear or disappear when signals are input and the signal status appear or disappear when the input signal is changed.  
 ON : The information is displayed.  
 OFF : The information is not displayed.

---

Item : 1080/1035  
 Settings : 1080/1035  
 Function : Makes the number of effective scanning lines appear or disappear when the HDTV signal is input.  
 1080 : Sets the number to 1080. (Select when the digital HDTV signal is input.)  
 1035 : Sets the number to 1035. (Select when the analogue HDTV signal is input.)

---

## 7. CONTROL LOCK

Item : CONTROL LOCK  
 Settings : OFF/ON  
 Function : Invalidates most of operations on the front panel (including menu screen operations).  
 OFF : Enables normal operations.  
 ON : Invalidates all operations except the power switch and CONTROL LOCK.

**NOTE:** While CONTROL LOCK is set to ON, attempting to perform any operation except power switch and CONTROL LOCK causes the "Control lock on!" warning to appear on the screen for approx. 3 seconds. (It is possible to operate the power switch and display SETUP MENU.)  
 When SETUP MENU is displayed while CONTROL LOCK is set to ON, the cursor (▶) is located next to CONTROL LOCK and cannot be moved.

## 8. all reset

Function : Sets all items in SETUP MENU to factory-preset values.



# I HOW TO USE EXTERNAL CONTROL

## ■ ABOUT EXTERNAL CONTROL

This multi-format monitor has two external control terminals. One is the MAKE terminal, which controls the monitor by connecting the terminals with many functions to the ground (GND) terminal. The other is the RS-232C terminal, which allows the monitor to be controlled by a PC via serial communication.

Control priority is in the following order; the MAKE terminal > the RS-232C terminal > the buttons on the front panel.

## ■ HOW TO USE THE MAKE TERMINAL

### Connections

Connect (short-circuit) the 15th terminal (GND) to each of the 1st through 14th terminals in the 3-lines 15-pins D-sub connector. The functions of each terminal are listed below.

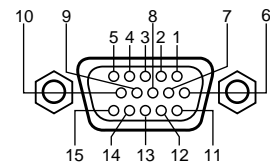

### The Names and Functions of Terminals

No.	Names	Functions	Operations (OFF ← → ON)		*1
1	TALLY	Puts on the tally lamp.	Put on	Put off	
2	INPUT A	Changes the input to INPUT A	Not change	Change	
3	INPUT B	Changes the input to INPUT B	Not change	Change	
4	INPUT C	Changes the input to INPUT C	Not change	Change	
5	INPUT D	Changes the input to INPUT D	Not change	Change	
6	INPUT E	Changes the input to INPUT E	Not change	Change	
7	INPUT F	Changes the input to INPUT F	Not change	Change	
8	COLOR OFF	Changes the picture black-and-white.	Not change	Change	
9	AREA MARKER	Displays the area marker.	Not display	Display	
10	ASPECT	Changes the screen ratio to 16:9	4:3	16:9	
11	UNDER SCAN	Makes the screen under-scan	Over-scan	Under-scan	
12	MARKER	Selects the type of the area marker	Selection in the main unit	Selection in the remote control	*2
13	STATUS	Displays the monitor's status	Display		*3
14	REMOTE ENABLE	Makes the external control form the MAKE terminal valid or invalid	Invalid	Valid	*4
15	GND	Used as a ground terminal	—	—	

\*1 : OFF stands for disconnection, and ON stands for short-circuit.

\*2 : Selects the area marker size from AREA MARKER (setting on the main unit) or AREA MARKER-R (setting on the remote control) setting.

\*3 : The STATUS function is activated when the connection to the STATUS terminal is changed (ON to OFF, or OFF to ON). The monitor's status is displayed for 3 seconds.

\*4 : Setting REMOTE ENABLE to ON enables remote control from the MAKE terminal.

### Operation

1. Set REMOTE ENABLE to ON.
2. Short-circuit or disconnect the desired terminal.

### Changing the Signal Input

1. Set REMOTE ENABLE to ON.
2. Short-circuit the desired INPUT terminal.
3. Disconnect the INPUT terminal selected above. The signal input is actually changed after the disconnection has been completed.

**NOTE** : When more than two terminals are selected (short-circuited) from INPUT A through INPUT F, the signal input is not changed.

To control INPUT A through INPUT F, we recommend using the interlock switch, which turns off a switch when another switch is turned on.

# HOW TO USE EXTERNAL CONTROL (cont.)

## HOW TO USE THE RS-232C TERMINAL

You can control the monitor from your PC via the RS-232C terminal.

For details on operating the monitor from the PC, consult your dealer or service centre for details.

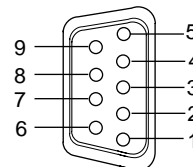

### 1. Cable

Prepare a straight cable with a D-sub connector (9-pin, female) and a D-sub connector (9-pin, male)

### 2. Communications Specifications

Baud Rate : 4800/9600/19200 (factory pre-set; 4800)  
 Data Bits : 8 bits  
 Parity : No parity  
 Stop Bits : 1  
 Flow Control : Hardware (RTS/CTS)

Pin No.	Signal
1	DCD (Data Carrier Detect)
2	RD (Recive Data)
3	TD (Transmit Data)
4	DTR (Data Terminal Ready)
5	GND (Ground)
6	DSR (Data Set Ready)
7	RTS (Request To Send)
8	CTS (Clear To Send)
9	RI (Ring Indication)

### 3. Commands

Format

Header	ID	Command	Data	CR
--------	----	---------	------	----

Header

- ! Control from the PC to the monitor
- ? Reference from the PC to the monitor
- @ Answer from the monitor to the PC

ID + Command + Data

ID	Command	Data	Characters
B	Basic command		00, 01 or No data
D	Command for adjusting the picture size	00 ~ 07	-20 ~ +20
S	Command for adjusting the picture quality	00 ~ 05	-20 ~ +20
M	Command for selecting the menu item	00 ~ 0E	00, 01, 10, 11
F	Command for selecting the menu item	00 ~ 07	00, 01
W	Command for adjusting the white balance	00 ~ 05	-256 ~ +255
C	Command for inquiring for the monitor's status	00 ~ 01	0 ~ 655 or No data

During Communication from the PC to the Monitor

The monitor receives the data when DSR remains ON (high) and CTS is set to ON.

During Communication from the Monitor to the PC

The monitor sends the data when both DSR and DCD are set to ON and RTS is set to ON.

Communication Procedures

The following is the communication procedures.

#### 1. Starting the communication

Receives the connection command (!BCN1Cr) from the PC → Sends the monitor's status (@BOKCr) to the PC

#### 2. Performing the external control

Receives the control command (!XXXXCr) from the PC → Sends the monitor's status (@BOKCr) to the PC

\* The monitor repeats these receiving and sending if necessary.

#### 3. Terminating the communication

Receives the termination command (!BCN0Cr) → Sends the monitor's status (@BOKCr) to the PC

\* After sending the data to the monitor, the PC must first receive the data from the monitor and then send the next command because the communication is performed in a hand-shake system. If the PC does not receive the status from the monitor after sending the command, re-send the command.

# TROUBLESHOOTING

Solutions to common problems related to your monitor are described here. If none of the solutions presented here solve the problem, unplug the monitor and consult a JVC-authorized dealer or service centre for assistance.

Problems	Points to be checked	Measures (Remedy)	Reference pages
<b>No power supply</b>	Is the power plug loosened or disconnected?	Firmly insert the power plug.	5
<b>No picture with the power on</b>	Is the signal cable disconnected?	Connect the signal cable firmly.	6, 7
	Is the power of the connected component ON? Is the signal output from the connected component?	Turn on the power of the connected component and set it correctly.	—
	Is the input signal selected correctly?	Select the correct input with the INPUT SELECT buttons.	5, 8
	Is the input signal adapted to the monitor's specification?	Check that the input signal format corresponds to the installed input card format.	6, 7
<b>No sound</b>	Is the audio cable disconnected?	Connect the audio cable firmly.	6, 7
	Is the audio signal output from the connected component?	Set the connected component correctly.	—
	Is the volume output set to minimum?	Adjust the speaker volume with the VOLUME +/- buttons.	4
<b>Wrong colour</b>	Has the picture adjustment been changed?	Set each picture adjustment knob to the standard (centred) position. Or, set each picture adjustment item in [ PICTURE SUB ADJ.] in the <SETUP MENU> screen to Standard (00) (or use the [reset] function).	9, 14
	Has the WHITE BALANCE setting been changed?	Set each [COLOR TEMP./BAL.] item in the <SETUP MENU> screen to Standard (000) (or use the [reset] function).	15
	Are any cables connected to the component/RGB input card?	Connect each signal cable firmly.	6
	Has the correct signal been input to the component/RGB input card and the correct INPUT been selected on the monitor?	Select INPUT A/C/E when the component signal is input, or select INPUT B/D/F when the RGB signal is input.	6
<b>Unnatural picture</b>	Has [CONTRAST] or [BRIGHT] been changed?	Adjust the CONTRAST or BRIGHT picture adjustment knobs. Or, adjust the [CONTRAST] or [BRIGHT] item in [PICTURE SUB ADJ.] in the <SETUP MENU> screen.	14
<b>Shaking picture</b>	Is the monitor close to a motor, transformer or any other device generating a strong magnetic field? (a fan, fluorescent light, laser printer, another monitor, etc.)	Move the monitor away from the device until the picture stops shaking. Connect the power plug to another AC outlet away from the former one.	—

# TROUBLESHOOTING (cont.)

Problems	Points to be checked	Measures (Remedy)	Reference pages
<b>Irregular colour</b>	Is the monitor placed or moved close to a speaker or any other device incorporating a magnet? Has the position of the monitor been changed with the power on?	Move the device away from the monitor. Press the DEGAUSS button on the front panel to degauss the screen. When degaussing, wait more than 30 minutes for maximum effect.	4
<b>Wrong picture position, wrong picture size</b>	Has the picture position, size or distortion been changed?	Adjust the picture size (H SIZE, V SIZE) or position (H. POSITION, V. POSITION) in the [SIZE/POSI. ADJ.] item in the <SETUP MENU> screen. Adjust the picture distortion (PINCUSHION, PIN. BALANCE, TRAPEZOID and PARALLELOGRAM) in the [DISTORTION ADJ.] item in the <SETUP MENU> screen. It may not be possible to expand the picture due to the selected input mode. In this case, adjustment is impossible.	15, 16
	Have the UNDER SCAN or ASPECT button been pressed?	When the UNDER SCAN or ASPECT button is lit, press each button to invalidate each setting.	4
<b>Front panel buttons and knobs do not function</b>	Has the CONTROL LOCK function been set to ON?	Set the CONTROL LOCK function to OFF.	16
	Has the monitor's setting been changed to enable control from an external unit via the REMOTE terminals?	Change the setting of the external control to control the monitor locally.	17, 18

## The following are not malfunctions:

- You may see two horizontal lines on the monitor. They are the shadows of the "damper lines" that are necessary for composing the monitor. These lines are not a malfunction.

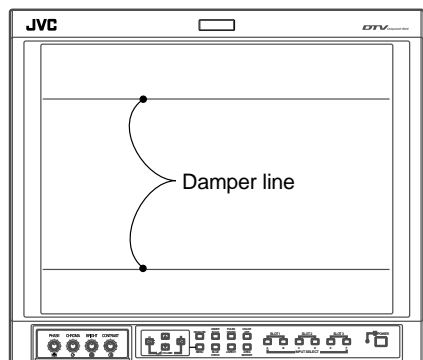

- When a bright still image (such as a white cloth) is displayed for a long period, it may appear to be coloured. This is due to the structure of the cathode ray tube and will disappear when another image is displayed.
- You may sometimes experience a mild electric shock when you touch the picture tube. This phenomenon is due to a normal buildup of static electricity on the CRT and is not harmful.
- The monitor emits a strange sound when the room temperature changes suddenly. This is only a problem if an abnormality appears on the screen as well.
- If two or more monitors are operated next to each other, their images may shake or be distorted. This phenomenon is due to mutual interference; it is not a malfunction. Move the monitors away from each other until the interference disappears or turn the power off on any monitor that is not being used.

# SPECIFICATIONS

- **Type** : Multi-format monitor
- **Picture Tube** : 17" measured diagonally
- **Effective Screen Size** : Width : 330 mm  
Height : 250 mm  
Diagonal : 410 mm
- **Scanning Frequency** : H : 15 kHz/15 kHz – 45 kHz  
V : 50 Hz – 100 Hz
- **Video Band** : Component : 25 MHz (–3 dB)  
Video (Y/C) : 8 MHz (–3 dB)
- **Horizontal Resolution** : Video (Y/C) : 600 TV lines  
1080/60i : 800 TV lines
- **Input Terminals** : Installing an optional input card in SLOT 1, 2, or 3 is required.  
INPUT A/INPUT B: Terminals on the input card in SLOT 1  
INPUT C/INPUT D: Terminals on the input card in SLOT 2  
INPUT E/INPUT F: Terminals on the input card in SLOT 3
- **Compliant Video Signal** : NTSC (3.58 MHz)/PAL (4.43 MHz) (using the IF-C01PNG)  
480i/576i/480p/1080i (60 Hz/24pSF)/720p (using the IF-C01COMG)
- **Remote Inputs** : D1 serial digital (using the IF-C01SDG)  
HD serial digital (using the IF-C01HSDG)
  - Point-of-contact connection, 1 line, D-sub connector (15-pin 3-line)
  - Serial connection, 1 line, D-sub connector (9-pin), compliant to RS-232C
- **Audio Output** : 1 W (monaural)
- **Built-in Speaker** : 8 cm round x 1
- **Environmental Conditions** : Operating temperature : 5°C – 35°C  
Operating humidity : 20% – 80% (non-condensing)
- **Power Requirements** : 120 V/230 V AC, 50 Hz/60 Hz
- **Power Consumption (120 V/230 V)** : 1.56 A/0.9 A (not including input card)  
Max. 1.85 A/1.0 A (including input card)
- **Dimensions** : Width : 395 mm  
Height : 334 mm  
Depth : 466.5 mm (not including wide mask and input card)
- **Weight** : 23.2 kg (not including wide mask and input card)
- **Accessory** : AC power cord

[Dimensions] Unit : mm  
<Front View>

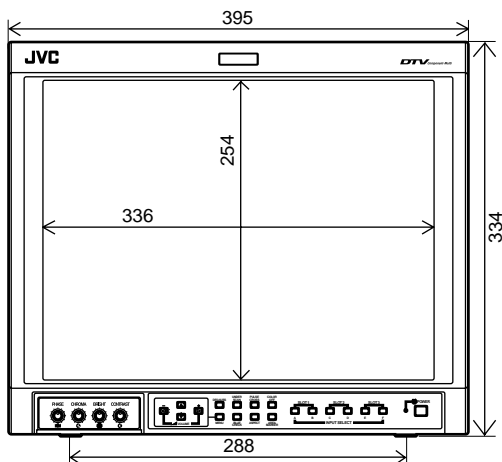

<Front View with the wide mask attached>

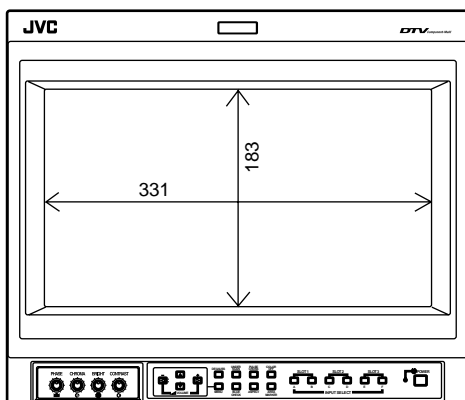

<Side View>

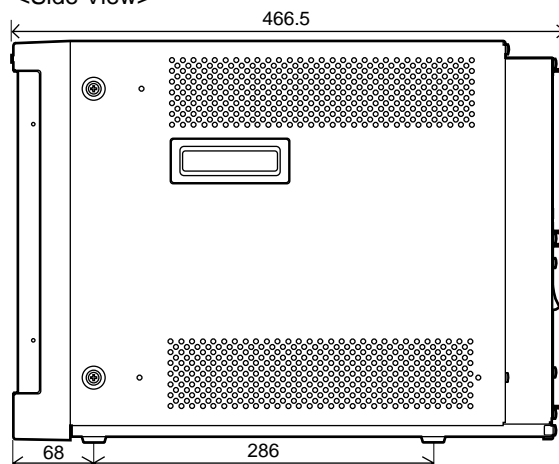

\* Illustrations and pictures used in this manual have been exaggerated, abbreviated or compounded for explanatory purposes only. The appearance of the actual product may differ slightly.  
\* Dimensions and weight are approximate.  
\* E. & O.E. Design and specifications subject to change without notice.

## ■ Compliant Signal Formats of Each Input Card

Input Signals	IF-C01PNG	IF-C01COMG	IF-C01SDG	IF-C01HSDG
NTSC (3.58 MHz)	○	—	—	—
PAL (4.43 MHz)	○	—	—	—
Black-and-White (50 Hz/60 Hz)	○	—	—	—
480/60i (525i)	—	○	○	—
480/60p (525p)	—	○	—	—
576/50i	—	○	○	—
576/50p (*1)	—	○	—	—
720/60p (720p)	—	○	—	○
1080/50i (*1)	—	○	—	○
1080/60i (1125i)	—	○	—	○
1035/60i (1125i) (*1)	—	○	—	○
1080/24pSF	—	○	—	○

○ : Input possible. Pre-set.

○ : Input possible. Not pre-set. Any adjustments required in some cases.

— : Input impossible

\*1 : 1080/50i, 1035/60i and 576/50p are not pre-set. When these signals are input, some adjustments are required.

# APPENDIX: CONNECTION EXAMPLES FOR THE SDI / HD SDI INPUT CARD

This section explains the usage precautions and connection examples when using the SWITCHED OUT terminal of the SDI / HD SDI input card.

### Usage Precautions

- The selected signal is output from the SWITCHED OUT terminal only when the monitor's power is turned on.
- The output signal from the SWITCHED OUT terminal is the one that is selected from the signals input to SDI 1 / HD SDI 1 or SDI 2 / HD SDI 2.

The table below shows the connection between the INPUT SELECT buttons (input signal selection) and the input/output of the SDI / HD SDI input card.

Selected INPUT SELECT Buttons	Signal Output from the SWITCHED OUT Terminal
A, C, E	Signal from SDI 1 / HD SDI 1
B, D, F	Signal from SDI 2 / HD SDI 2

# SPECIFICATIONS (INPUT CARD: OPTIONAL)

## ■ IF-C01COMG: COMPONENT/RGB INPUT CARD

Type	: Component/RGB input card for multi-format monitor
Inputs/Outputs	: Component (Y, P <sub>B</sub> /B-Y, P <sub>R</sub> /R-Y) or RGB: 1 line, BNC connector x 6 (Y: 1 V (p-p), 75 Ω/P <sub>B</sub> , B-Y, P <sub>R</sub> , R-Y, R, G, B: 0.7 V (p-p), 75 Ω) Synchronised signal (HD/Cs, VD) : 1 line, BNC connector x 4 (1.0 V – 4.0 V (p-p), 75 Ω) * The input (IN) and output (OUT) terminals are bridge-connected. Auto termination. Audio signal : 1 line (monaural), RCA pin x 2 (0.5 V (rms), high impedance) * The input (IN) and output (OUT) terminals are bridge-connected.
Required slots	: 1
Power consumption	: 14 V DC, 0.02 A
Weight	: 0.5 kg
Dimensions (W x H x D)	: 43 mm x 154.5 mm x 191.9 mm

## ■ IF-C01PNG: VIDEO INPUT CARD

Type	: Video input card for multi-format monitor
Inputs/Outputs	: VIDEO 1/VIDEO 2: 2 lines, BNC connector x 4 (1 V (p-p), 75 Ω) Synchronised signal (EXT.SYNC): 1 line, BNC connector x 2 (1.0 V – 4.0 V (p-p), 75 Ω) * The input (IN) and output (OUT) terminals are bridge-connected. Auto termination. Y/C signal : 1 line, input only, mini-DIN 4-pin connector x 1 (Y/C input has a priority to a VIDEO 2 input) (Y: 1 V (p-p), 75 Ω/C: 0.286 V (NTSC)/0.3 V (PAL), 75 Ω) Audio signal : 2 lines (monaural), RCA pin x 4 (0.5 V (rms), high impedance) * The input (IN) and output (OUT) terminals are bridge-connected.
Required slots	: 1
Power consumption	: 14 V DC, 0.25 A 7 V DC, 0.15 A
Weight	: 0.5 kg
Dimensions (W x H x D)	: 43 mm x 154.5 mm x 191.9 mm

## ■ IF-C01SDG: SDI INPUT CARD

Type	: SDI input card for multi-format monitor
Inputs/Outputs	: Digital input (SDI 1/SDI 2): 2 lines, BNC connector x 2 (0.8 V (p-p), 75 Ω) Digital output (SWITCHED OUT): 1 line, BNC connector x 1 (0.8 V (p-p), 75 Ω) Audio signal: 2 lines (monaural), RCA pin x 4 (0.5 V (rms), high impedance) * The input (IN) and output (OUT) terminals are bridge-connected.
Format	: D1 serial component digital, 525/625 auto switching (compliant to SMPTE259M)
Required slots	: 1
Power consumption	: 7 V DC, 0.65 A
Weight	: 0.5 kg
Dimensions (W x H x D)	: 43 mm x 154.5 mm x 191.9 mm

## ■ IF-C01HSDG: HD SDI INPUT CARD

Type	: HD SDI input card for multi-format monitor
Inputs/Outputs	: Digital input (HD SDI 1/HD SDI 2): 2 lines, BNC connector x 2 (0.8 V (p-p), 75 Ω) Digital output (SWITCHED OUT): 1 line, BNC connector x 1 (0.8 V (p-p), 75 Ω) Audio signal: 1 line (monaural), RCA pin x 2 (0.5 V (rms), high impedance) * The input (IN) and output (OUT) terminals are bridge-connected.
Format	: HD serial component digital, SMPTE292M, SMPTE274M, SMPTE296M, SMPTE1920 X 1080 24pSF
Required slots	: 1
Power consumption	: 7 V DC, 0.72 A
Weight	: 0.7 kg
Dimensions (W x H x D)	: 43 mm x 154.5 mm x 200.2 mm

---

**JVC**<sup>®</sup>

**JVC PROFESSIONAL PRODUCTS COMPANY**

DIVISION OF US JVC CORP.

1700 Valley Road Wayne, N.J. 07470

**JVC CANADA INC.**

21 Finchdene Square, Scarborough Ontario M1X 1A7



## Free Manuals Download Website

<http://myh66.com>

<http://usermanuals.us>

<http://www.somanuals.com>

<http://www.4manuals.cc>

<http://www.manual-lib.com>

<http://www.404manual.com>

<http://www.luxmanual.com>

<http://aubethermostatmanual.com>

Golf course search by state

<http://golfingnear.com>

Email search by domain

<http://emailbydomain.com>

Auto manuals search

<http://auto.somanuals.com>

TV manuals search

<http://tv.somanuals.com>